



User Guide

1. User Guide. Introduction	10
2. Description of the Software Package	11
2.1 Basic principles of building a security system based on the Axxon Next software package	11
2.2 Basic subsystems of the Axxon Next software package and their functions	11
2.2.1 Video subsystem	11
2.2.2 The Audio Subsystem	12
2.2.3 The Analytics Subsystem	13
2.2.4 The PTZ Subsystem	13
2.2.5 The Event Registration Subsystem	13
2.2.6 The Notification Subsystem	14
2.2.7 The Relay Subsystem	14
2.2.8 Forensic Search in Archive Subsystem	14
2.2.9 Functions of the Distributed Security System	14
2.3 Specifications of the Axxon Next Software Package	15
2.4 Implementation Requirements for the Axxon Next Software Package	16
2.4.1 Limitations of the Axxon Next Software Package	16
2.4.2 Operating system requirements	17
2.4.3 Requirements for Personnel Quantity and Qualifications	19
2.5 Interface of the Axxon Next Software Package	19
3. Installing the Axxon Next Software Package	19
3.1 Installing equipment	19
3.1.1 Types of Devices Used	19
3.1.2 Connecting IP Devices	20
3.1.3 Configuring IP Devices in Windows	20
3.1.4 Particulars of Configuration of Devices	21
3.2 Installation the Axxon Next Software Package	24
3.2.1 Types of Installation	24
3.2.2 Installation	24
3.2.3 Repairing Installation	31
3.2.4 Removal	32
3.2.5 Update	34
4. Licensing of the software product	35
4.1 Axxon Next license types	35
4.2 Licensing methods	35
4.3 Product Activation Utility	36
4.4 License Activation	37
5. Launching and Closing the Axxon Next Software Package	37
5.1 Startup	37
5.1.1 Starting a Server	37
5.1.2 Starting an Axxon Next Client	37
5.1.3 Running multiple Axxon Next Clients	39
5.1.4 Demo mode notification	40
5.2 Shutdown	41
5.2.1 Shutting down an Axxon Next Client	41
5.2.2 Shutting down a Server	41
5.3 Switching Users Quickly	42
5.4 Connecting to Another Server Quickly	42
6. Configuration of the Axxon Next Software Package	42
6.1 General Information on Configuring System Objects	42
6.1.1 Procedure for Configuring System Objects	42
6.1.2 List of Servers for an Axxon Domain	44
6.1.3 Searching for Unallocated Servers and Hardware	44
6.1.4 Creating Device Objects Manually	46
6.1.5 Object search	46
6.2 Configuring Axxon domains	47
6.2.1 Axxon Domain operations	48
6.2.1.1 Creating a new domain	48
6.2.1.2 Adding a Server to an existing Axxon Domain	48

6.2.1.3 Removing a Server from an Axxon Domain	50
6.2.2 Cases of Axxon Domain configuration	50
6.3 Preliminary Configuration of Devices	51
6.4 Configuring System Objects for Devices	54
6.4.1 The Server Object	55
6.4.2 The Video Camera Object	55
6.4.2.1 Configuring fisheye cameras	59
6.4.2.2 Configuring virtual video cameras	59
6.4.2.3 Configuring connection of video cameras via RTSP	60
6.4.3 The IP Server Object	61
6.4.4 The Microphone Object	62
6.4.5 The Telemetry Object	63
6.4.6 The Sensor Object	65
6.4.7 The Relay Object	66
6.4.8 The Speaker Object	67
6.4.8.1 Creating an Object	68
6.4.8.2 Configuring a Speaker Object	68
6.4.8.3 Checking Audio Notification	69
6.4.9 The E-mail Object	70
6.4.9.1 Creating the E-mail Object	70
6.4.9.2 Configuring the E-mail Object	70
6.4.9.3 Checking E-mail Notification	71
6.4.10 The SMS Object	72
6.4.10.1 Procedure of configuring SMS notifications	72
6.4.10.2 Creating the SMS Object	72
6.4.10.3 Configuring the SMS Object	72
6.4.10.4 Checking SMS notifications	73
6.5 Configuring the web server	73
6.6 Configuring video camera groups	74
6.6.1 Procedure for configuring video camera groups	75
6.6.2 Creating a Group object	75
6.6.3 Adding video cameras created in the system to Group objects	76
6.6.4 Creating a system of groups and subgroups	77
6.6.5 Managing Group and Video camera objects	77
6.7 Configuring detection tools	79
6.7.1 Types of detection tools	79
6.7.2 Video suitability for detection tools (requirements)	80
6.7.3 Situation Analysis Detection Tools	80
6.7.3.1 Types of Situation Analysis Detection Tools	80
6.7.3.2 Procedure for Configuring Situation Analysis Detection Tools	81
6.7.3.3 Enabling Situation Analysis	81
6.7.3.4 Setting General Parameters	82
6.7.3.5 Setting Common Detection Zones	83
6.7.3.6 Creating a Detection Tool object	83
6.7.3.7 Setting Virtual Elements	84
6.7.3.8 Settings Specific to Loitering Detection	86
6.7.4 Video Analytic	86
6.7.4.1 Types of Video Detection	86
6.7.4.2 Procedure for Configuring Video Detection	86
6.7.4.3 Enabling Video Detection	87
6.7.4.4 Setting General Parameters of Video Motion Detection	87
6.7.4.5 Settings Specific to Video Motion Detection	88
6.7.5 Audio analytics	88
6.7.5.1 Types of Audio Detection	88
6.7.5.2 Procedure for Configuring Audio Detection	88
6.7.5.3 Enabling Audio Detection	89
6.7.5.4 Setting General Parameters of Audio Detection	89
6.7.5.5 Settings Specific to the Signal and Noise detections	90
6.7.6 Embedded Analytics	90

6.7.6.1	How to configure on-board detection tools	90
6.7.6.2	Creating an on-board detection tool object	90
6.7.6.3	Configuring a Sony Ipela detection tool	90
6.7.7	Sensors	91
6.7.8	Checking the Triggering of a Detection Tool	92
6.7.9	Configuring Automatic Rules	92
6.7.9.1	Types of Automatic Rules	93
6.7.9.2	Automatic Rule Execution Modes	93
6.7.9.3	Adding an automatic rule	93
6.7.9.4	Conditions for Setting Automatic Rules	94
6.7.9.5	Recording to Archive and Initiation of an Alarm	95
6.7.9.6	Switching to the layout with the minimum number of cells to display the selected video camera.	96
6.7.9.7	Launching an external program on clients	97
6.7.9.8	Switching Relays	98
6.7.9.9	Switching to a PTZ camera preset	99
6.7.9.10	Voice notification	99
6.7.9.11	E-mail notification	100
6.7.9.12	SMS notification	100
6.8	Configuring Archives	100
6.8.1	General Information of Configuring Archives	100
6.8.2	Creating archives	101
6.8.2.1	Creating a new archive as a file	101
6.8.2.2	Creating a new archive as a partition	102
6.8.2.3	Creating an archive based on an existing file or partition	104
6.8.3	Configuring Recording of the Video Stream from Video Cameras to the Archive	105
6.8.4	Viewing Archive Fullness	107
6.8.5	Deleting Archives	107
6.9	Configuring layouts	108
6.9.1	Layouts ribbon modes	108
6.9.2	Switching between layout types	108
6.9.3	Creating and deleting layouts	109
6.9.4	Layout copying	110
6.9.5	Editing layouts	110
6.9.5.1	Switching to layout editing mode	110
6.9.5.2	Selecting a layout for editing	111
6.9.5.3	Configuring layout cells	111
6.9.5.3.1	Adding new cells to a layout	111
6.9.5.3.2	Resizing cells	113
6.9.5.3.3	Moving cells	114
6.9.5.3.4	Adding cameras to cells	114
6.9.5.3.5	Adding information boards to cells	115
6.9.5.3.6	Clearing cells	115
6.9.5.4	Configuring viewing tiles	115
6.9.5.4.1	Selecting default functions for viewing tiles	115
6.9.5.4.2	Selecting the default video mode for a camera	116
6.9.5.4.3	Moving sensor and relay icons in a viewing tile	116
6.9.5.4.4	Configuring default zoom levels (the Fit screen function)	116
6.9.5.4.5	Configuring pan/tilt angle for video cameras with Immervision lenses in 180 Panorama display format	116
6.9.5.5	Configuring information boards	117
6.9.5.5.1	Linking information boards and viewing tiles	117
6.9.5.5.2	Configuring information board templates	118
6.9.5.5.3	Configuring Events Boards	118
6.9.5.5.4	Configuring a Health Board	119
6.9.5.5.5	Configuring a Statistics Board	120
6.9.5.6	Exiting layout editing mode	121
6.10	Configuring the Interactive Map	122

6.10.1	Creating a new map	122
6.10.2	Adding system objects to the map	123
6.10.2.1	Adding video cameras	123
6.10.2.2	Adding sensors and relays	124
6.10.2.3	Adding switches to another map	125
6.10.3	Configuring cameras on the map	125
6.10.3.1	Configuring a camera in standard map viewing mode	125
6.10.3.2	Configuring cameras in immersion mode	126
6.10.4	Attaching a map to a layout	127
6.10.5	Removing objects from the map	128
6.10.6	Changing map type and display	128
6.10.7	Renaming the map	128
6.10.8	Sorting of map lists	128
6.10.9	Deleting a map	128
6.11	Configuring Forensic Search in Archive	129
6.11.1	Video suitability for Forensic Search of recorded video (requirements)	129
6.11.2	Possible ways to configure recording to the video stream archive	129
6.11.3	Enabling recording of video stream metadata	129
6.11.4	Configuring user permissions for Forensic Search in archive	130
6.12	Configuring the user interface	130
6.12.1	Selecting the interface language	130
6.12.2	Selecting the calendar type	131
6.12.3	Configuring Slideshow parameters	131
6.12.4	Hiding tooltips	132
6.12.5	Configuring auto hide for panels	133
6.12.6	Configuring animation	134
6.12.7	Configuring Display of Video Statistics	135
6.12.8	Configuring Display of Error Messages	136
6.12.9	Configuring previews of alarm events	137
6.12.10	Configuring map autozoom	138
6.12.11	Configuring the timeline	139
6.12.11.1	Configuring the Day/night style	139
6.12.11.2	Configuring the Shift work style	140
6.12.12	Configuring Interfaces on a Multi-Monitor Computer	142
6.12.13	Configuring the Client screen mode (full screen or window)	143
6.13	Configuring how Axxon Next starts	144
6.13.1	Configuring Axxon Next instead of the standard Windows OS shell	144
6.13.2	Configuring autologon	145
6.14	Configuring storage of the archive, system log, and metadata	146
6.15	Configuring export	147
6.16	Configuring Alarm Management Mode	148
6.17	Configuring schedules	148
6.17.1	Creating schedules	149
6.17.2	Deleting a schedule	150
6.18	Creating and Configuring the Role and User System Objects	150
6.18.1	The Role object	150
6.18.2	The User Object	152
7.	Working with the Axxon Next Software Package	154
7.1	Main Elements of the User Interface	154
7.1.1	Viewing Tile	154
7.1.1.1	Color Coding of Frames	154
7.1.1.2	Viewing Tile Context Menu	155
7.1.1.3	Time Display	155
7.1.1.4	Display of Video Statistics	156
7.1.1.5	Video Surveillance Mode Selection Tabs	156
7.1.2	Information boards	157
7.1.3	Layouts	158
7.1.3.1	Select the displayed layout	158
7.1.3.2	Layout slideshow	158

7.1.4 Interactive Map	159
7.1.5 Video camera panel	159
7.1.6 The Archive Navigation Panel	160
7.1.6.1 The Structure and Function of the Archive Navigation Panel	160
7.1.6.2 Events Filter	161
7.1.6.3 The Timeline	162
7.1.6.4 Events List	168
7.1.6.5 The Playback Panel	169
7.1.7 Advanced archive navigation panel	170
7.1.8 The PTZ Control Panel	171
7.1.8.1 The Enter number Panel	173
7.1.8.2 The Presets List	173
7.2 Video Surveillance	175
7.2.1 Video Surveillance Modes	175
7.2.2 Functions Available in All Video Surveillance Modes	176
7.2.2.1 Selecting a video camera	176
7.2.2.2 Scaling the Viewing Tile	177
7.2.2.3 Digitally Zooming Video Images	178
7.2.2.3.1 Enlarging a video image using the digital zoom scale	178
7.2.2.3.2 Enlarging a video image through area selection	179
7.2.2.3.3 Enlarging a video image using the mouse scroll wheel	180
7.2.2.4 Video image processing	181
7.2.2.4.1 Changing the Contrast Level	181
7.2.2.4.2 Setting the Sharpness Level	182
7.2.2.4.3 Using Deinterlacing	183
7.2.2.5 Tracking objects	184
7.2.2.6 Operator comments	185
7.2.2.6.1 Adding comments in different surveillance modes	185
7.2.2.6.2 Adding a comment	186
7.2.3 Real-time video surveillance	188
7.2.3.1 Switching to Live Video Mode	188
7.2.3.2 Video Surveillance Functions Available in Live Video Mode	189
7.2.3.3 Arming and Disarming a Video Camera	189
7.2.3.4 Using the Snapshot function	190
7.2.3.5 Controlling a PTZ Camera	191
7.2.3.5.1 Control Using the Presets List	192
7.2.3.5.2 Control Using the Enter number Panel	193
7.2.3.5.3 Control Using a Virtual Joystick	193
7.2.3.5.4 Patrolling	194
7.2.3.5.5 Control using Point&Click	194
7.2.3.5.6 Control using Areazoom	194
7.2.3.6 Managing Relays	195
7.2.3.7 Displaying the sensor status	196
7.2.3.8 Selecting video stream quality in a viewing tile	197
7.2.3.9 Autozoom	198
7.2.3.10 Viewing the results of a saved search query	199
7.2.4 Video surveillance in archive mode	201
7.2.4.1 Switching to Archive Mode	201
7.2.4.2 Video Surveillance Functions Available in Archive Mode	203
7.2.4.3 Selecting an Archive	204
7.2.4.4 Synchronized playback of archives	204
7.2.4.5 Compressed playback of archives (Time Compressor)	205
7.2.4.5.1 Switching to Time Compressor mode	205
7.2.4.5.2 Playback control	206
7.2.4.5.3 Switching back to the original recording of an object	207
7.2.4.6 Viewing recorded video with operator comments	208
7.2.4.7 Navigating in the Archive	209
7.2.4.7.1 Navigating Using the Timeline	209
7.2.4.7.2 Navigation using the advanced panel	211

7.2.4.7.3	Navigating Using the Events list	212
7.2.4.7.4	Navigating Using the Playback Panel	212
7.2.4.7.5	Navigation via the time indicator	213
7.2.4.7.6	Keyboard navigation	214
7.2.4.7.7	Flip-through navigation of recordings	214
7.2.4.8	Displaying the causes of triggered situation analysis detection units	215
7.2.5	Video surveillance in Alarm Management mode	215
7.2.5.1	Video surveillance functions available in Alarm Management mode	215
7.2.5.2	Initiating an Alarm	216
7.2.5.2.1	Manual Initiation	216
7.2.5.2.2	Automatic Initiation	217
7.2.5.3	Accepting an alarm for processing	217
7.2.5.4	Switch to Alarm Management mode	219
7.2.5.5	Working with the Alarm Management window	219
7.2.5.5.1	Alarm Handling Tile Interface Elements	220
7.2.5.5.2	Alarm Playback	220
7.2.5.5.3	Processing an Alarm	222
7.2.5.6	Limitations when working with alarm events in case of multi-user processing	223
7.2.6	Video surveillance in Archive Search mode	223
7.2.6.1	Switching to Archive Search mode	223
7.2.6.2	Archive Search mode interface	224
7.2.6.3	Video surveillance functions available in Archive Search mode	226
7.2.6.4	Setting a search interval	227
7.2.6.5	Events search	227
7.2.6.6	Forensic Search for Fragments	228
7.2.6.6.1	Forensic Search steps	228
7.2.6.6.2	Selecting search criteria and adding parameters	229
7.2.6.6.3	Editing visual elements	230
7.2.6.6.4	Configure the search parameters	233
7.2.6.6.5	Launching a search	237
7.2.6.6.6	Saving search queries	238
7.2.6.7	Time search for video fragments	239
7.2.6.8	Searching comments	240
7.2.6.9	Switching between search results	240
7.2.6.10	Working with video fragments corresponding to found moments	240
7.2.6.10.1	Playback of video fragments	241
7.2.6.10.2	Enlargement of found moments	241
7.2.6.10.3	Exporting the video fragments and repeated search	242
7.2.7	Working with fisheye cameras	242
7.2.7.1	Viewing modes for video from fisheye cameras	242
7.2.7.1.1	360 degree Panorama and Regional view (virtual telemetry)	242
7.2.7.1.2	180 degree Panorama	243
7.2.7.2	Fisheye cameras on an interactive map	244
7.2.7.2.1	Viewing video and controlling a fisheye camera from the map	244
7.2.7.2.2	Fisheye cameras in immersive mode	244
7.3	Working with information boards	245
7.3.1	Resizing information boards	245
7.3.2	Hiding information boards	245
7.3.3	Automatically switching to layouts with information boards	246
7.3.4	Working with Events Boards	246
7.3.4.1	Options for displaying information on Events Boards	246
7.3.4.2	Switching a camera linked to an Events Board to the archives	247
7.3.5	Working with Health Boards	248
7.3.5.1	Viewing server status	249
7.3.5.2	Viewing camera status	251
7.3.6	Working with Statistics Boards	254
7.4	Audio Monitoring	255
7.4.1	General Information	255

7.4.2	Activating audio monitoring	256
7.4.3	Volume control	256
7.5	Working with the Interactive Map	256
7.5.1	Opening and closing the map	256
7.5.2	Changing the map tilt	257
7.5.3	Scaling and focusing of map	258
7.5.4	Adjusting transparency of map video	259
7.5.5	Immersive mode	259
7.5.6	Switching between maps	260
7.5.7	Controlling devices from the map	262
7.5.8	Displaying device status	262
7.6	Exporting Frames and Video Recordings	263
7.6.1	Frame export	263
7.6.2	Exporting Video Recordings	263
7.7	Event Control	265
7.7.1	Control in Live Video Mode	265
7.7.2	The System Log	265
7.7.2.1	Setting Event Search Filters	266
7.7.2.2	Event search procedure	266
7.7.2.3	Refreshing Event Search Results	267
7.7.2.4	Viewing Event Search Results	267
7.7.2.5	Exporting Event Search Results	268
7.7.2.6	Switching to archive video of specific events	269
7.8	Working with Axxon Next Through the Web Client	269
7.8.1	Starting the web client	269
7.8.2	Searching for video cameras in the web client	270
7.8.3	Real-time video surveillance via the web client	271
7.8.4	Viewing video archives through the web client	272
7.8.5	Archive position selection panel for the web client	272
7.8.6	Digital video zoom in the web client	273
7.8.7	Controlling PTZ cameras through the web client	273
7.8.7.1	Controlling a PTZ camera through the web client by using presets	274
7.8.7.2	Changing the optical zoom of a PTZ camera in the web client	274
7.8.7.3	Changing the positioning speed of a PTZ camera in the web client	275
7.8.7.4	Changing the tilt of a PTZ camera in the web client	275
7.8.8	Web client message window	275
7.9	Working with Axxon Next Through the Mobile Clients	275
8.	Description of utilities	276
8.1	Activation Utility	276
8.2	Axxon Support Tool	277
8.2.1	Purpose of the Support.exe Utility	278
8.2.2	Launching and Closing the Utility	278
8.2.3	Description of the Support.exe utility interface	278
8.2.4	The Processes Service	279
8.2.5	Collecting Data on the Configuration of Servers and Clients Using the Support	280
8.3	Log Management Utility	282
8.3.1	Starting and closing the utility	283
8.3.2	Configuring a Log Archive	283
8.3.3	Configuring Logging Levels	284
8.4	Digital Signature Verification Utility	285
9.	Appendices	286
9.1	Appendix 1. Glossary	286
9.2	Appendix 2. Known issues in the Axxon Next Software Package	288
9.2.1	Possible Errors During Installation	288
9.2.2	Possible Errors During Start-Up	289
9.2.3	Possible Errors During Operation	289
9.3	Appendix 3. Assigning of the domain takes place when the Axxon Next server is installed	290

9.4 Appendix 4. Using Axxon Next with anti-virus software . . . . .	290
9.5 Appendix 5. Using CH VM-Desktop USB multifunction controllers with Axxon Next	
291	

# User Guide. Introduction

## On page:

- [General Information](#)
- [Purpose of the Document](#)
- [Purpose of the Axxon Next Software Package](#)

## General Information

No part of this document may be reproduced or transmitted in any form or by any means without the prior written permission of *AxxonSoft*.

The *Axxon Next* trademark is the property of *AxxonSoft*. All other trademarks included in this document are the property of their respective owners.

All information contained in this document is current as of the publication date. *AxxonSoft* reserves the right to change or update this document without the prior notification of or to any third party.

## Purpose of the Document

This document, titled [User guide](#) contains the information necessary for building, implementing, and operating a security system based on *Axxon Next*.

The structure of this document enables the user to get acquainted with the software package and then, depending on the user's level of training, choose sections of interest for more detailed study. The chapters in this guide, whether they are informative or serve as a reference, have their own internal structure.

The chapters [Introduction](#) and [Description of the Software Package](#) are intended to generally acquaint the user with the technical features and functionality of the Axxon Next software package, as well as with the key stages of building a security system based on the software package.

Recommendations to the user/administrator for installing the software and configuring equipment are presented in detail in the chapter [Installing the Axxon Next Software Package](#). The chapter [Licensing of the software product](#) contains instructions on how to register a license to use the Axxon Next software package..

Startup and shutdown of the software package are described in the chapter [Launching and Closing the Axxon Next Software Package](#).

The chapter [Configuration of the Axxon Next Software Package](#) presents step-by-step instructions on configuring user-specific settings and activating the required functionality. This information is useful for system administrators as well as for operators with permissions to manage system settings.

Recommendations on configuring the user interface, working in various video surveillance modes, and utilizing the functional capabilities of the Axxon Next software package are presented in chapter [Working with the Axxon Next Software Package](#).

Chapter [Description of utilities](#) contains a description of additional software utilities employed when working with the software package.

The [Appendices](#) contains a glossary of the product's basic terms and definitions. It also lists all known issues that you may encounter while using Axxon Next.

## Purpose of the Axxon Next Software Package

The Axxon Next software package is an entry-level product in the Axxon product line developed by AxxonSoft. Security systems based on Axxon Next range from home security systems (for an apartment or house) to professional security systems for small and mid-size businesses (hotels, automotive service centers, shops, parking structures, etc.).

Video and audio surveillance of guarded locations, video analysis, and rapid response to suspicious situations without operator involvement, and storage and export of obtained data are just a few of Axxon Next's many functions.

The Axxon Next software package enables the user to accomplish a wide spectrum of tasks, as it works both with digital equipment and with analog video cameras (through video capture cards), and also makes it possible to create a hybrid security system containing both kinds of equipment.

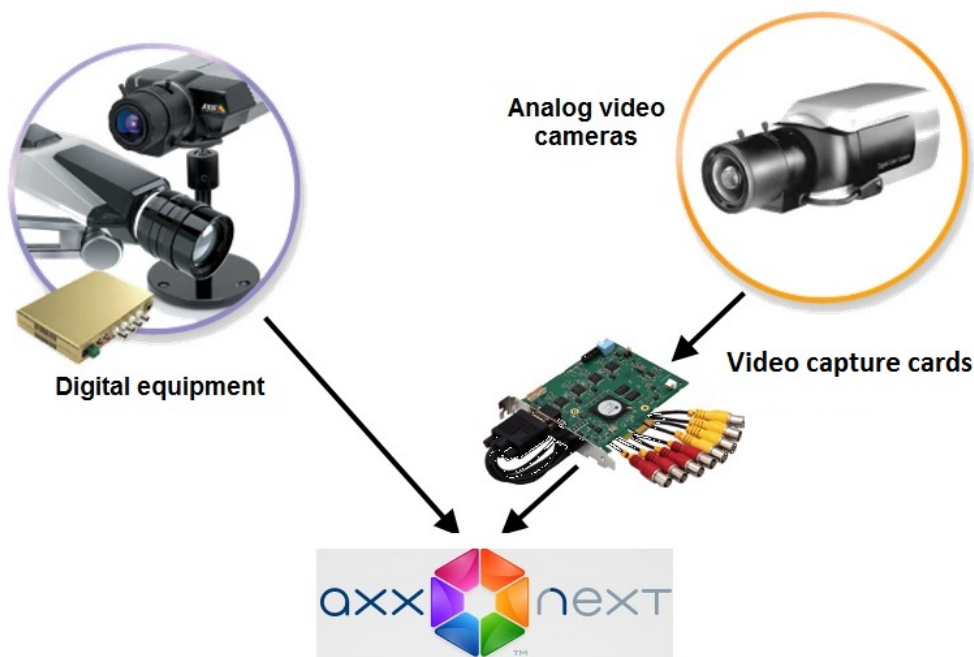

The Axxon Next software package supports touchscreens.

## Description of the Software Package

### Basic principles of building a security system based on the Axxon Next software package

Building a security system based on the Axxon Next software package includes the following recommended stages:

1. Selecting a configuration for the security system (with the help of professionals)
2. Building a separate local area network with restricted access
3. Calculating the sufficient bandwidth required for each segment of the local area network
4. Selecting and configuring the software and hardware platform on which the selected security system configuration will be implemented (selecting and configuring personal computers to act as servers and clients in accordance with the requirements, as referenced in the section titled [Implementation Requirements for the Axxon Next Software Package, Operating system requirements](#))
5. Selecting and connecting reliable equipment that is optimally suited for a specific security system (with the help of professionals)
6. Training personnel to work with the Axxon Next software package in accordance with the requirements (see the section titled [Requirements for Personnel Quantity and Qualifications](#)).

### Basic subsystems of the Axxon Next software package and their functions

In order to determine the required configuration for a security system, first you must become familiar with the functional capabilities of the Axxon Next software package. The following subsystems provide these capabilities:

1. The video subsystem
2. The audio subsystem
3. The analytics subsystem
4. The PTZ subsystem
5. The event registration subsystem
6. The notification subsystem
7. The relay subsystem

These subsystems can interact in either a single-server or multi-server (distributed) system.

This section provides information on the software's basic functions.

#### Video subsystem

The video subsystem encompasses all the tools that provide for the acquisition of video data, its processing, and its storage on media.

Video data comes in from IP devices connected over TCP/IP or from analog video cameras connected through video capture cards.

Video data in the Axxon Next software package is processed automatically by the analytics subsystem or manually by an

operator. Depending on the task, the results of the video data processing are transferred to and utilized by other subsystems of the software package, including the event registration subsystem, the notification subsystem, and others.

The following system objects enable the functions of the video subsystem:

1. **Camera**
2. **IP server**

The functions of the video subsystem take place through the following user interfaces:

1. Video surveillance monitor
2. Viewing tile
3. Control elements accessible to the user in the **Layouts** tab

Thanks to Axxon Next's video subsystem, the user can utilize the following functions:

1. Viewing video images in a supported resolution from a video camera while simultaneously listening to the audio from a microphone linked to that camera (if it is connected to an IP server) or connected to it physically
2. Displaying information in a viewing tile:
  - a. Current time
  - b. Name of video camera
  - c. Audio volume
  - d. Indicator of recording of video image from a camera
  - e. Video stream settings (if configured accordingly; see the section [Configuring Display of Video Statistics](#))
3. Video image processing
  - a. Digital zooming
  - b. Contrast adjustment
  - c. Deinterlacing
  - d. Sharpness adjustment
4. Modifying layouts, including changing the sizes of viewing tiles
5. Displaying a magnified video image from a selected video camera (viewing tile)
6. Displaying a snapshot initiated by an operator, without interrupting video recording
7. Color coding a viewing tile (video camera) to indicate its status: **Alarm**, **No alarm**, **Snapshot**, etc.
8. Video recording can be performed:
  - a. continuously;
  - b. video recording initiated by a detection tool or by an operator, with a pre-alarm recording option;
  - c. scheduled video recording.
9. Recording to archive (video and audio streams are written to one file)
10. Storage and export of single frames and video sequences
11. Playback of video image recorded to the archive from one or more video cameras (in the latter case, playback will be synchronous) with simultaneous playback of sound recorded together with the video



**Note**

In the case of synchronous playback of video from several video cameras, the sound is played back only from the microphone of the active video camera

12. Working with alarms registered by one or more video cameras:
  - a. Navigating between archive recordings of alarms
  - b. Viewing brief information on an alarm and its recording in the archive
  - c. Filtering alarms
13. Using any Client to view video footage from all Servers over TCP/IP

## The Audio Subsystem

The audio subsystem encompasses all the tools that provide for the collection of audio data, its processing, and its storage on media.

Audio data comes in from microphones which are either linked to video cameras (only for video cameras connected to IP servers) or physically connected to video cameras (embedded and external microphones).



**Note**

The indicator that a microphone is linked/physically connected to a video camera is that it will be a child of the video camera object

Audio data is processed both automatically by the analytics subsystem and manually by the operator. Depending on the task, the results of the audio data processing are transferred to and utilized by other subsystems of the software package, including the event registration subsystem, the notification subsystem, and others.

The **Microphone** system object enables the functions of the audio subsystem. You can access these functions through the Viewing tile context menu.

Thanks to Axxon Next's audio subsystem, the user can utilize the following functions:

1. Listening to audio from a microphone linked to a video camera while simultaneously viewing video images from that camera
2. Recording to archive (video and audio streams are written to the same file)
3. Simultaneous playback of the video and audio recordings of an event

4. Using any client to listen to audio from all servers over TCP/IP

## The Analytics Subsystem

The analytics subsystem encompasses all the tools that provide for automatic analysis of incoming video and audio data.

### Note

The operator also has the option of analyzing video and audio data manually

Depending on the task, the results of the data analysis are transferred to and utilized by other subsystems of the software package, such as the event registration subsystem, the notification subsystem, the relay subsystem, and others.

Integrated use of the following types of detection tools enables the functions of the analytics subsystem:

1. Situation analysis detection tools
2. Basic video detection tools
3. Basic audio detection tools
4. On-board detection tools of video cameras (video stream processing)
5. Embedded analytics (processing of signals from a "dry contact" sensor of a video camera).

The results of the video data processing appear on the video surveillance monitor.

Thanks to Axxon Next's analytics subsystem, the user can utilize the following functions:

1. Setting detection zones and/or masks
2. Detecting the beginning and/or stop of motion of an object in a set area of a video camera's field of view
3. Detection of an object crossing a set line in a video camera's field of view
4. Detecting the appearance and/or disappearance of an object in a set area of a video camera's field of view
5. Detecting abandoned items in a set area of a video camera's field of view
6. Detecting loitering (prolonged presence) in a set area of a video camera's field of view
7. Detecting changes in the position of a video camera in space
8. Detecting loss of image quality
9. Detecting the absence/presence of an audio signal from a microphone
10. Detecting noise
11. Functions for video stream processing, provided by the on-board video camera detection tools that are part of Axxon Next
12. Processing of signals (non-contact/contact) from embedded "dry contact" sensors of video cameras, with the possibility of configuring the execution of a specific action when such signals are received (see next item)
13. Setting the responses that are automatically executed when a detection tool is triggered (individually for each detection tool)
14. Simultaneous use of various types of detection tools

## The PTZ Subsystem

The PTZ subsystem encompasses all the tools that provide for remote control of a PTZ device and the lens of a video camera.

In the Axxon Next software package, the **Telemetry** system object enables the functions of the PTZ subsystem. You can access these functions through the PTZ device control panel.

### Note

You can also control a PTZ device with a physical USB joystick (the system automatically determines when such a device is connected to a computer with Axxon Next installed)

Thanks to Axxon Next's PTZ subsystem, the user can utilize the following functions:

1. Setting and using preset video camera positions (presets)
2. Automatic modification of video camera position along a route offered in the camera's list of presets (patrolling)
3. Controlling a video camera's lens: Modifying the parameters of the iris, focus, and optical zoom
4. Manual modification of a video camera's horizontal and vertical tilt angle using a virtual joystick

## The Event Registration Subsystem

Event registration subsystem – all the tools that provide for the collection of data about system events, processing, and its storage on media.

In the Axxon Next software package, the system (internal) log, which is kept by default, along with the utility for managing optional external logs, enables and implements the functions of the event registration subsystem.

Thanks to Axxon Next's event registration subsystem, the user can utilize the following functions:

1. Real-time display of error data
2. Storage of system event data in a local database on the server
3. Viewing of system event data stored in the system log
4. Searching for data about system events which occurred within a certain time period
5. Filtering by event type when searching the system log
6. Filtering by a key phrase found in the system description of an event when searching the system log

7. Exporting system event data in the required format
8. Logging of data about the required events in external logs and archiving and storing it on media.

## The Notification Subsystem

The notification subsystem encompasses all the tools that provide for notification of the user about events which have occurred in the system.

In the Axxon Next software package, the following system objects enable the functions of the notification subsystem:

1. **Speaker**
2. **SMS**
3. **E-mail**

The notification subsystem does not require a user interface.

Thanks to Axxon Next's notification subsystem, the user can utilize the following functions when detection tools are triggered:

1. Audio notification
2. SMS notification
3. E-mail notification

## The Relay Subsystem

The relay subsystem encompasses all the tools that provide for the triggering of an execution device connected to the embedded relay port of a video camera or IP server when a detection tool (including one which processes the embedded sensor of a video camera or IP server) is triggered.

In the Axxon Next software package, **Relay** system objects enable the functions of the relay subsystem. The relay subsystem does not require user interfaces.

Thanks to Axxon Next's relay subsystem, the user can configure the triggering of a video camera's or IP server's on-board relay when a detection tool is triggered.

## Forensic Search in Archive Subsystem

The Forensic Search in archive subsystem is a set of tools for searching video recordings in the archive by using video image metadata. The video image metadata include information on the trajectories of object motion in the video camera's field of view, object color, etc. (depending on the algorithms being executed on the video camera).

In the *Axxon Next* software package, the functions of the Forensic Search in archive subsystem are enabled by the object trajectory database (which is created when the software package is installed). These functions can be accessed through the video surveillance monitor.

Thanks to *Axxon Next's* Forensic Search in archive subsystem, the user can utilize the following functions:

1. Selection of a video camera from which it is necessary to record video image metadata to the object trajectory database.
2. One-time searching by one of the criteria related to the video camera's field of view:
  - a. Motion in a specific area
  - b. Crossing of a virtual line
  - c. Loitering of an object in a specific area
  - d. Simultaneous presence of a large number of objects in a specific area
  - e. Motion from one area to another
3. Searching by the following parameters (optional):
  - a. Minimum size of an object
  - b. Maximum size of an object
  - c. An object's color
  - d. Minimum speed of an object
  - e. Maximum object speed
  - f. Direction of an object's motion
  - g. Maximum number of objects in an area
  - h. Length of time an object remains in an area

## Functions of the Distributed Security System

You can create a distributed system within an Axxon Domain on Axxon Next.

Axxon Domain – a selected group of computers on which the server configuration of the *Axxon Next* software package is installed. Linking the servers in a group makes it possible to set up interaction between them, thus organizing a distributed system.

Only servers which belong to the same Axxon Domain can interact.

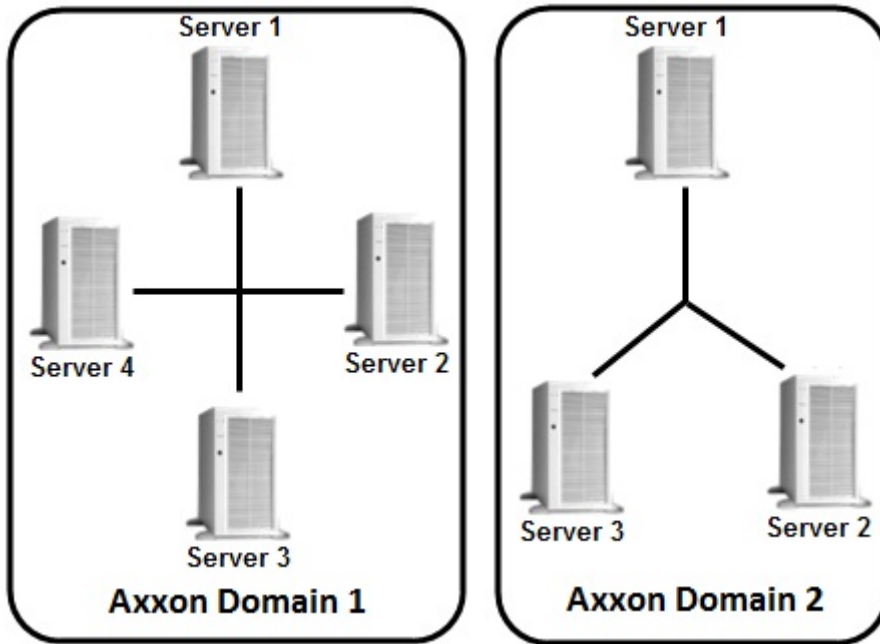

A distributed security system based on the Axxon Next software package offers the user the following functional capabilities:

1. Viewing and manual processing of video and audio data from several servers on one client
2. Controlling video cameras connected to various servers from one client
3. Configuring all servers of the distributed system on one client
4. Execution of automatic responses when detection tools are triggered (audio notification, triggering of relays, SMS and e-mail notification, etc.) within the distributed system.



**Note**

If a Server is not accessible by NetBiosName or some TCP and UDP ports are closed, it is possible to build a distributed security system on a virtual private network (VPN). For example, with the help of [OpenVPN](#). Detailed information on OpenVPN and examples of virtual private network configuration are given in the [official documentation](#)

Axxon Domain configuration is described in detail in the section titled [Configuring Axxon domains](#).

## Specifications of the Axxon Next Software Package

Security systems based on the Axxon Next software package have the following primary characteristics.

Characteristics	Value
Number of servers in the distributed system	Unlimited
Number of clients which support simultaneous connection to the server	Unlimited
Number of servers which simultaneously transmit video images to a client	Unlimited
Number of video capture channels for "live video" processing on one Server	Unlimited
Number of simultaneously processed signals coming from microphones	Unlimited
Number of audio output channels (to speakers, headphones, etc.)	depends on the sound card used for playback
Number of PTZ devices used	Unlimited
Number of video images displayed simultaneously on a client's screen	up to 25
Analog video camera support	yes (through video capture cards)
IP device support	IP cameras and IP video servers This list is continuously expanding: support for new hardware is added through updates to Axxon Driver Pack

Number of archives in the system	Unlimited
Video compression algorithms	MJPEG, MPEG-2, MPEG-4, MxPEG, H.264, Motion Wavelet
Available video image resolutions	resolutions supported by video cameras
Support for embedded video camera analytics	yes
Support for touchscreens	yes

## Implementation Requirements for the Axxon Next Software Package

### Limitations of the Axxon Next Software Package

When working with Axxon Next, the user must keep in mind the limitations that the developer has imposed on the system in order to ensure its operability.

No.	Limitation
1	<p>To work with Axxon Next software the following requirements for OpenGL are to be fulfilled:</p> <ol style="list-style-type: none"> <li>1. version 2.0 and higher;</li> <li>2. Availability the <b>ARB_vertex_program</b>, <b>GL_EXT_blend_func_separate</b>, <b>GL_ARB_framebuffer_object</b> extensions.</li> </ol> <p>Extensions availability can be checked using the OpenGL Extension Viewer program (<a href="#">download</a>). This program also contains a large database of data on OpenGL support in video cards of various vendors.</p>
2	The Axxon Next PC client cannot be started on screens with resolution of less than 1024x768
3	To install Axxon Next, you must log in to Windows as an administrator.
4	The computer name can contain only Latin characters, Arabic numerals, and/or a minus sign ( - ).
5	For proper installation of Axxon Next, there should be no spaces at the beginning of the name of the folder which contains the installer
6	Once Axxon Next has been installed, the computer name cannot be changed
7	For all features of Axxon Next to work properly, the system must not have any restrictions on network activity. Make sure that access is open to all TCP and UDP ports
8	Time must be synchronized among all computers in the system (to be configured by the user). Time on servers and on the cameras linked to them must be synchronized as well
9	Before installing Axxon Next, make sure the video card drivers on the computer are fully up to date
10	Remote access to a computer must be made via NetBiosName; the client and server must be able to ping each other by IP and NetBiosName
11	The NetBiosName of the computer may contain up to 15 characters.
12	When configuring the firewall, limiting the network activity by ports is not allowed, since Axxon Next uses the entire range of TCP ports
13	The Client cannot be started on a remote desktop through the Remote Desktop Connection utility built into Windows

14	<p>If a computer is linked to an Active Directory domain, one of the following conditions must be met to enable disk access:</p> <ol style="list-style-type: none"> <li>1. Access control lists must contain only local or built-in groups and users.</li> <li>2. Create an <b>AxxonFileBrowser</b> user in the domain and add it to the <b>Users</b> group.</li> </ol> <p>This behavior is typical only of file systems that have access permissions (for example, NTFS).</p>
----	--

## Operating system requirements

Axxon Next software package is compatible with 32-bit and 64-bit licensed versions of Microsoft Windows operating system.

Windows version	Supported edition	Note	
Windows XP SP2 (x64)	Windows XP Professional	OS edition, enabling to use all realized product features	
Windows XP SP3 (x86)	Windows XP Home Edition	Restrictions, imposed by OS edition (1 physical processor, 5 SMB connections) – see <a href="http://www.microsoft.com">http://www.microsoft.com</a>	
	Windows XP Professional	OS edition, enabling to use all realized product features	
	Windows XP Tablet PC Edition	OS edition, enabling to use all realized product features	
	Windows XP Media Center Edition	OS edition, enabling to use all realized product features	
Windows Server 2003 R2 SP2 (x86, x64)	Standard Edition	OS edition, enabling to use all realized product features	
	Enterprise Edition	OS edition, enabling to use all realized product features	
	Datacenter Edition	OS edition, enabling to use all realized product features	
	Web Edition (x86)	Restrictions, imposed by OS edition (2 Gb RAM, 2 physical processors) – see <a href="http://www.microsoft.com">http://www.microsoft.com</a>	
Windows Vista SP2 (x86, x64)	Home Basic	Restrictions, imposed by OS edition (1 physical processor, 5 SMB connections) – see <a href="http://www.microsoft.com">http://www.microsoft.com</a>	
	Home Premium	Restrictions, imposed by OS edition (1 physical processor) – see <a href="http://www.microsoft.com">http://www.microsoft.com</a>	
	Business	OS edition, enabling to use all realized product features	
	Enterprise	OS edition, enabling to use all realized product features	
	Ultimate	OS edition, enabling to use all realized product features	
Windows Server 2008 SP2 (x86, x64)	Enterprise	OS edition, enabling to use all realized product features.	Full Installation type is supported. Server Core Installation type is not supported
	Datacenter	OS edition, enabling to use all realized product features.	
	Standard	OS edition, enabling to use all realized product features.	
	Web	OS edition, enabling to use all realized product features.	
	HPC	OS edition, enabling to use all realized product features.	

Windows Server 2008 R2 SP1 (x64)	Enterprise	OS edition, enabling to use all realized product features.	Full Installation type is supported. Server Core Installation type is not supported
	Datacenter	OS edition, enabling to use all realized product features.	
	Standard	OS edition, enabling to use all realized product features.	
	Web	OS edition, enabling to use all realized product features.	
	HPC	OS edition, enabling to use all realized product features.	
	Foundation	OS edition, enabling to use all realized product features.	
Windows 7 SP1 (x86, x64)	Starter (x86)	Restrictions, posed by OS edition (2GB of main memory, 1 physical processor, 1 monitor) - see <a href="http://www.microsoft.com">http://www.microsoft.com</a>	Stretch cards are supported in 32-bit version only
	Home Basic	Restrictions, posed by OS edition (1 physical processor) - see <a href="http://www.microsoft.com">http://www.microsoft.com</a>	
	Home Premium	Restrictions, posed by OS edition (1 physical processor) - see <a href="http://www.microsoft.com">http://www.microsoft.com</a>	
	Professional	OS edition, enabling to use all realized product features.	
	Enterprise	OS edition, enabling to use all realized product features.	
	Ultimate	OS edition, enabling to use all realized product features.	
Windows 8 (x86, x64)	Core	Axxon Next cannot be run as a Windows shell.	
	Pro	Axxon Next cannot be run as a Windows shell.	
	Enterprise	Axxon Next cannot be run as a Windows shell.	
Windows Server 2012 (x64)	Foundation	Restrictions, posed by OS edition (1 physical processor)  Axxon Next cannot be run as a Windows shell.	Full Installation type is supported. Server Core Installation type is not supported
	Essentials	Restrictions, posed by OS edition (2 physical processors)  Axxon Next cannot be run as a Windows shell.	
	Standard	Axxon Next cannot be run as a Windows shell.	

## Requirements for Personnel Quantity and Qualifications

The following roles have been defined for operating the Axxon Next software package:

1. Security system administrator
2. Security system operator

In special cases, one person can perform the functions of both the administrator and the operator.

The main duties of the administrator are to:

1. Update, configure, and monitor the operability of the security system's hardware
2. Install, update, configure, and monitor the operability of basic and system software
3. Install, configure, and monitor software applications
4. Manage user accounts (this duty can be carried out by a user entrusted with system administrator permissions).

The administrator must have the skills necessary for network configuration, including routing and firewall, as well as NetBIOS, DNS, and NTP network services.

Besides, the administrator must have high qualifications and practical experience installing, configuring, and administering the software and hardware employed in the software package.

The software package is structured so that all accessible functionality can be managed by one administrator or administration responsibilities can be divided among several users.



The main duties of an operator are to:

1. Work with the software's GUI (graphical user interface)
2. Optimize the performance of the personal computer to carry out tasks using the functionality provided in the software package
3. Create roles and users in the system (if the user has been granted the appropriate permissions)

The system operator must have experience with, and be a qualified user of, PCs running Microsoft Windows and must be able to easily perform basic operations.

## Interface of the Axxon Next Software Package

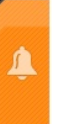
The interface of the Axxon Next software package consists of three expanding menus:

1. Layouts 
2. alarms 
3. Options 

When you click a tab's icon, the tab expands and the previously expanded tab collapses. One of the menus is always expanded.

Access to any given menu is configured individually for each role in the system (see the section titled [Creating and Configuring the Role and User System Objects](#)).

If the appropriate settings are enabled (see the section titled [Configuring auto hide for panels](#)), when there is no activity in the system, the system first shrinks and then hides the panel for switching between menus, i.e., the control panel.

## Installing the Axxon Next Software Package

### Installing equipment

### Types of Devices Used

An IP device is the source of the video signal (video data) for the Axxon Next software.



**Note**

You can connect analog video cameras to Axxon Next via video capture cards, which the software defines as IP devices

The following types of equipment are IP video and audio surveillance devices:

1. IP video cameras
2. Various types of IP video servers

IP video servers which use analog video cameras directly connected to them, digitize the analog video signal, and transmit it to users via TCP/IP. When working with analog video cameras connected to IP video servers, users can utilize the same video image viewing and transmission functions as with IP video cameras.

## Connecting IP Devices

To work with IP devices, you need to connect the Axxon Next server to the local network where the required IP devices are enabled.

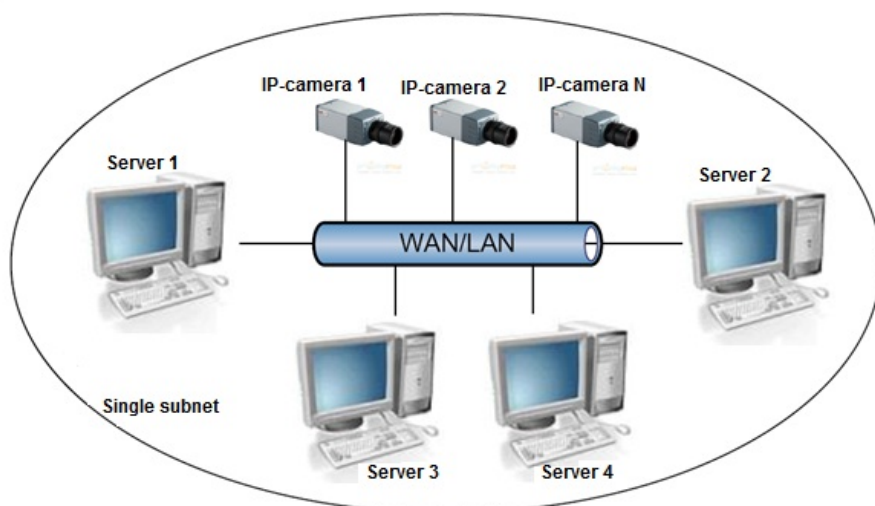

To ensure support for IP devices on an external network:

- The IP devices must have an external static IP address.
- The necessary ports on the network equipment must be opened.



### Attention!

If these requirements are met, IP devices should be properly handled. However, correct functioning is not guaranteed

Based on the video signal coming in from the IP device, an assessment is made of the guarded location and the system responds to events registered for that location. The content and quality of the obtained video information depends on how the IP device is installed and configured. There are a number of rules that must be followed to obtain a high-quality video signal. In particular, high-quality peripheral equipment (hubs/routers) must be used; we advise against use of Home and Office-class devices, which are not intended for use in such security systems.



### Note

IP devices connected to such equipment will transmit a video stream with an unacceptably long delay (from 1.5 to 3 seconds per frame)

Detailed information about creating a local network and connecting IP equipment to it is presented in the corresponding reference documents.

## Configuring IP Devices in Windows

IP devices can be configured in Windows by using the following software:

1. Software included with the IP device This software is used to accomplish the following tasks:
  - a. Searching for network devices connected to the local network
  - b. Preliminary IP address assignment (without account of routing)



### Attention!

Without assigning preliminary IP addresses to the devices, it is not possible to access their Web interface

2. Web interface of the IP device. This interface is used to accomplish the following tasks:
  - a. Configuring the IP devices with consideration for routing

- b. Configuring modes for the IP devices to work with video and audio signals
- c. Viewing video images coming in from IP devices in standard Web browser mode

Configuration of IP devices in Windows is described in detail in the official reference documentation for the respective devices.

## Particulars of Configuration of Devices

On page:
<ul style="list-style-type: none"> <li>• <a href="#">Axis IP Devices</a></li> <li>• <a href="#">Stretch video capture cards</a></li> <li>• <a href="#">WS-216 video capture cards</a></li> <li>• <a href="#">IP devices which partially support the ONVIF protocol</a></li> <li>• <a href="#">Sony IP Devices</a></li> <li>• <a href="#">Joysticks</a></li> <li>• <a href="#">CH VM-Desktop USB multifunction controller</a></li> <li>• <a href="#">Configuring Vivotek Panoramic PTZ</a></li> </ul>

### Axis IP Devices

For Axis IP devices on which the Bonjour function is supported and enabled, changing the default value of the **Friendly name** parameter is strongly discouraged. If an arbitrary **Friendly name** value is set for an Axis IP device, a search for connected equipment in the Axxon Next software package will give incorrect results for this IP device.



#### Note

The Friendly name parameter is configured through the Web interface of the IP device: Setup -> System options -> Network -> Bonjour



#### Note

The default value of the Friendly name parameter is as follows: AXIS <model name> - <mac address>, where <model name> is the model of the Axis IP device and <mac address> is its MAC address (for example, AXIS 214 - 00408C7D2610)

### Stretch video capture cards

If a Stretch VRC6004, VRC6008, VRC6404HD, VRC6416, VRC7008L, or VRC7016LX video card is installed, the choice of incoming video signal (PAL or NTSC) is made automatically, based on the video cameras connected to the card. Changes to this setting do not affect operation of the card.



#### Attention!

For video cameras connected through Stretch cards, it is impossible to display object tracking from embedded detection units in the viewing tile in Axxon Next

### WS-216 video capture cards

In *Axxon Next*, each WS-216 video capture card corresponds to two devices: manufacturer **ITV**, model **TW5864 PCI** (driver **Yuan, 2**) and manufacturer **CaptureDevice**, model **CaptureDevice** (driver **DShow, 1**).



In Axxon Next, to view cameras that are connected through a WS-216 video capture card, add the **ITV TW5864 PCI (2)** device to the configuration.

**Note**

Axxon Next does not support receiving uncompressed video from WS-216 video capture cards.

For video cameras that are connected through WS-216 video capture cards, you can choose one of the two codecs for a video stream:

1. H.264 (configurable)
2. H.264 (minimum resolution, non-configurable)

### IP devices which partially support the ONVIF protocol

To connect IP devices which only partially support ONVIF functions to the Axxon Next software package, you must use an ONVIF driver (**1**) with compatibility mode enabled.

**Note**

Such video cameras include Hikvision models and early versions of firmware from Sony, Samsung, and others.

Compatibility mode makes it possible to receive a video image from video cameras; however, some capabilities of the Axxon Next software package will be unavailable.

Enabling compatibility mode for a video camera (2) connected using the ONVIF protocol (1) is recommended if the connection settings are correct, but there is no video image.

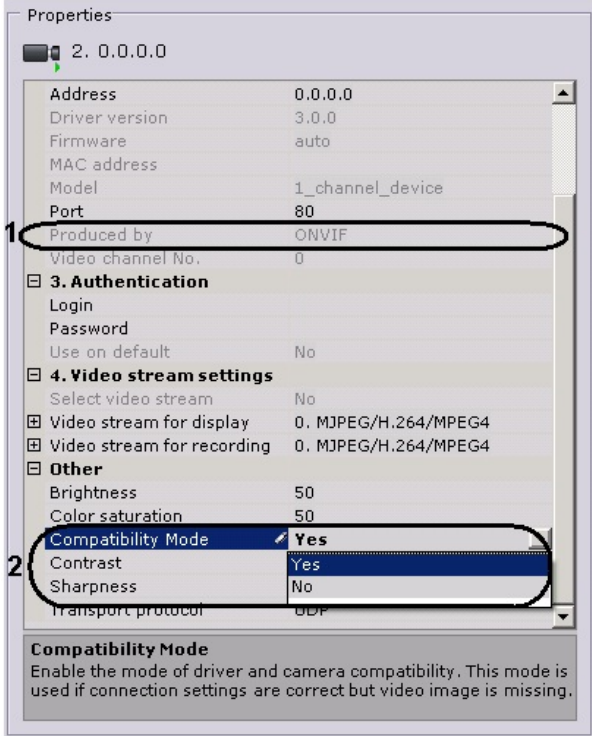

## Sony IP Devices

Some Sony models support encoding of the video signal in two formats simultaneously. To use this option you must perform the following steps:

1. Select the value **Yes** for the **Video stream selection** and **Dual encoding** settings.
2. From the **Codec priority** list, select the codec which will take priority when dual encoding.

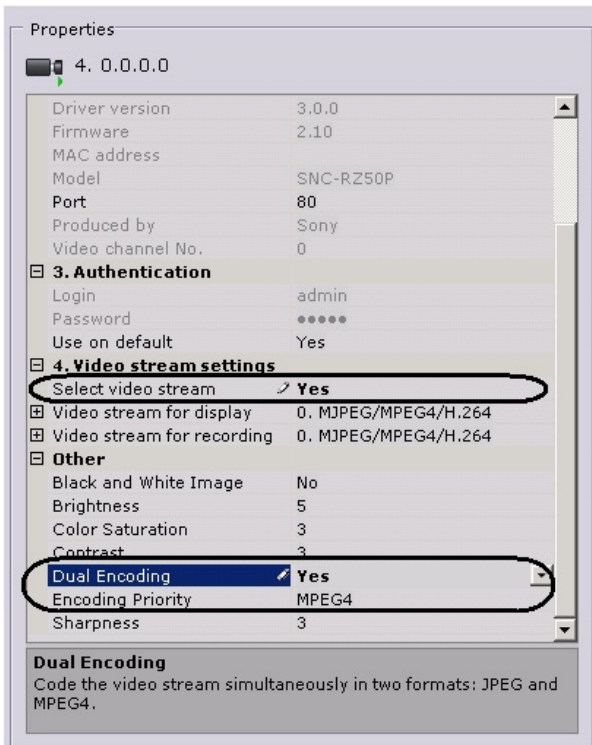

## Joysticks

Only joysticks that are detected in Windows as gaming input devices can be used in Axon Next for controlling PTZ cameras.

Information on how to view the status for a connected joystick is available in official Microsoft [documentation](#).

## CH VM-Desktop USB multifunction controller

For the controller to work properly in Axxon Next, the controller must be connected before the Axxon Next client is started.



### Note

To learn about connecting the device, consult the manufacturer's official documentation.

Controller keys cannot be remapped.

Use of the CH VM-Desktop USB multifunction controller in Axxon Next is described in the corresponding [section](#).

## Configuring Vivotek Panoramic PTZ

Vivotek Panoramic PTZ is a technology for linking a fisheye camera to a PTZ camera.

This Vivotek technology allows simultaneously maintaining full situational awareness in the field of view of a fisheye camera, while maintaining the ability to carefully monitor a specific area in depth by using a PTZ unit.

Vivotek Panoramic PTZ is supported by the fisheye cameras Vivotek SF8172 and Vivotek SF 8172V and by the PTZ camera Vivotek SD8362E.

To use this technology in Axxon Next:

1. Install and configure the cameras in accordance with the [official Vivotek documentation](#).
2. Add the cameras to an Axxon Next configuration.

Vivotek Panoramic PTZ support in Axxon Next is implemented via the Areazoom (see [Control using Areazoom](#)) and Point&Click functions (see [Control using Point&Click](#)).

# Installation the Axxon Next Software Package

## Types of Installation

The following two types of installations are available when installing Axxon Next to a personal computer:

1. **Server and Client**— This type of installation is used to accomplish the following tasks:
  - a. Physical connection to a personal computer and software configuration of video and audio capture devices (video cameras, microphones), event generation devices (sensors, relays, etc.), and hard disks for organizing data archives
  - b. Configuring the security system architecture (creating the necessary system objects and defining the connections between them)
  - c. Installing the software's user interfaces, which enable any user to connect to any server within a single security system and to perform administration/management/monitoring of a guarded location based on the permissions granted by the administrator
2. **Client** – This type of installation is used for installing the software's user interfaces, which enable any user to connect to any server within a single security system and to perform administration/management/monitoring of a guarded location based on the permissions granted by the administrator.

The way in which the basic properties of a computer in the security system depend on the type of Axxon Next installation is presented later.

Properties / type of installation	Client	Server and Client
A constant connection to another machine is required	+	-
Devices are connected locally	-	+
A local user interface is available	+	+

## Installation

To install Axxon Next, regardless of the type of installation, you must perform the following steps:

1. Insert the Axxon Next installation CD into the CD-ROM drive. A dialog box will display the disk content

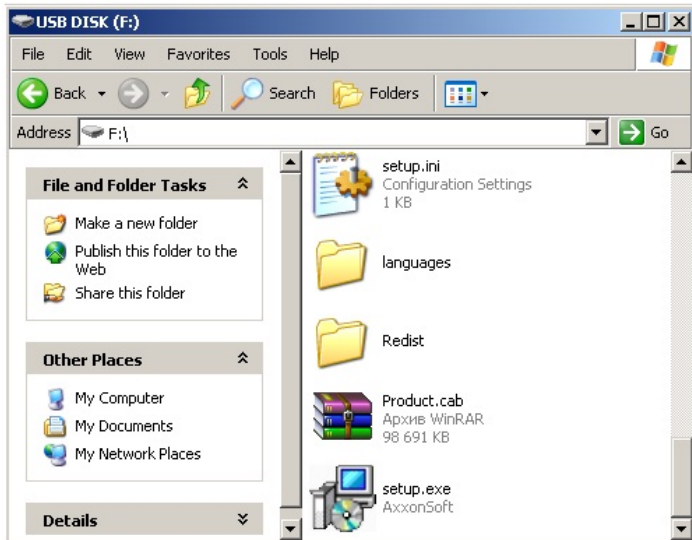

**Note**

The ITV Group website provides access to a leaner Axxon Next distribution package that does not include installation packages for .NET Framework 2.0 or .NET Framework 3.5 SP1. In this case, you must manually install that software prior to installing the Axxon Next software package

2. Run the Setup.exe file.
3. In the dialog box, choose the desired language from the list and click **OK**.

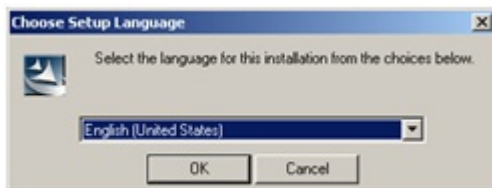

This setup wizard will now prepare for installation.

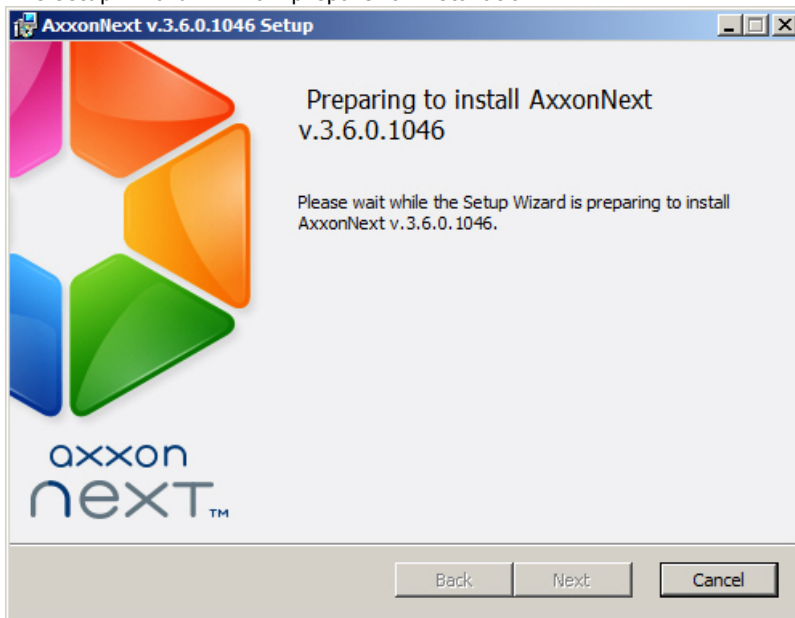

If .NET Framework 3.5 SP1 is not installed already, you will be asked to install it. To do this, you must agree with the license agreement in the .NET Framework 3.5 SP1 installation program and then follow its interactive instructions.



**Note**

The .NET Framework 3.5 SP1 software is automatically bundled only with Windows 7



**Attention!**

In some cases when installing *.NET Framework 3.5 SP1* on Windows 8 or Windows Server 2012, an error

may cause installation of *Axxon Next* to close. If this happens, manually install *.NET Framework 3.5 SP1* (see the guide) and try again to install *Axxon Next*

- Click **Next** on the setup wizard's welcome screen.



- To proceed with installation, accept the terms of the license agreement by selecting the radio button next to **I accept the terms of the License Agreement** and click **Next**.

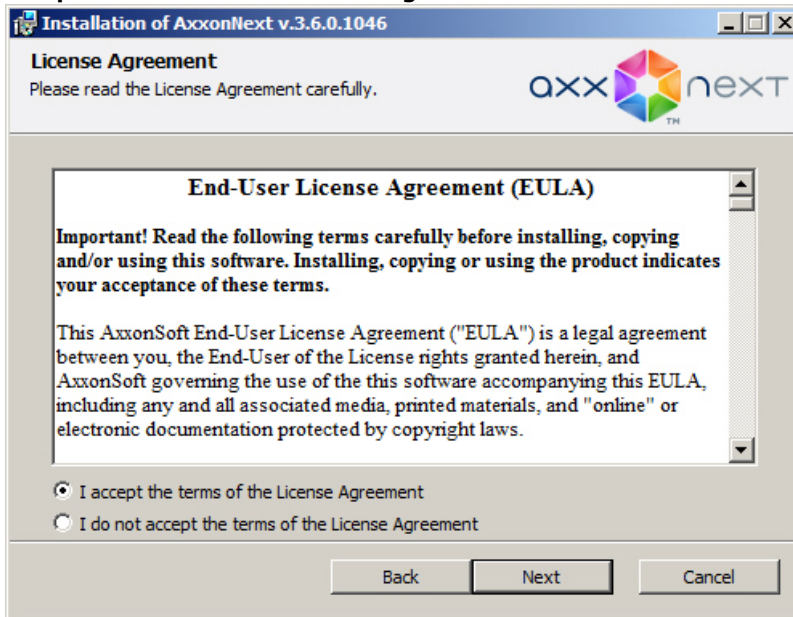

- Select the Axxon Next software installation type in the dialog box by clicking the appropriate option button and click **Next**.



7. Indicate the destination folders for installation of Axxon Next components and click **Next**. Components include both Axxon Next and the databases used in its operation: the log database and the object trajectory database.



**Attention!**

You are advised to place the log database and object trajectory database on a disk that has sufficient space. If you will be using only a log database, the disk capacity must be at least 5% larger than the archive size. If you will also be using a trajectory database, the disk must be at least 15% larger than the archive.

The following formulas can help to determine the required disk size for the trajectory database:

**Size of object trajectory database =  $N \times T \times (0,5\text{Gb} / \text{day})$** – sufficient disk size;

**Size of object trajectory database =  $N \times T \times (1\text{Gb} / \text{day})$** – sufficient disk size plus reserve space;

**Size of object trajectory database =  $N \times T \times (5\text{Gb} / \text{day})$** – sufficient disk size plus a large reserve.

**N** equals the number of video cameras in the system actively recording metadata; **T** equals the period of time (number of days) that metadata will be stored. By default, T = 30 days.



**Note**

By default, the software will be installed to the directory C:\Program Files\AxxonSoft\Axxon Smart\. By default, the log database and the object trajectory database will be placed in the directory C:\Program Files\AxxonSoft\Axxon Smart\Metadata (in the pg\_tablespace and vmda\_db subdirectories, respectively)



**Note**

To add quick launch shortcuts or desktop shortcuts, select the corresponding check boxes

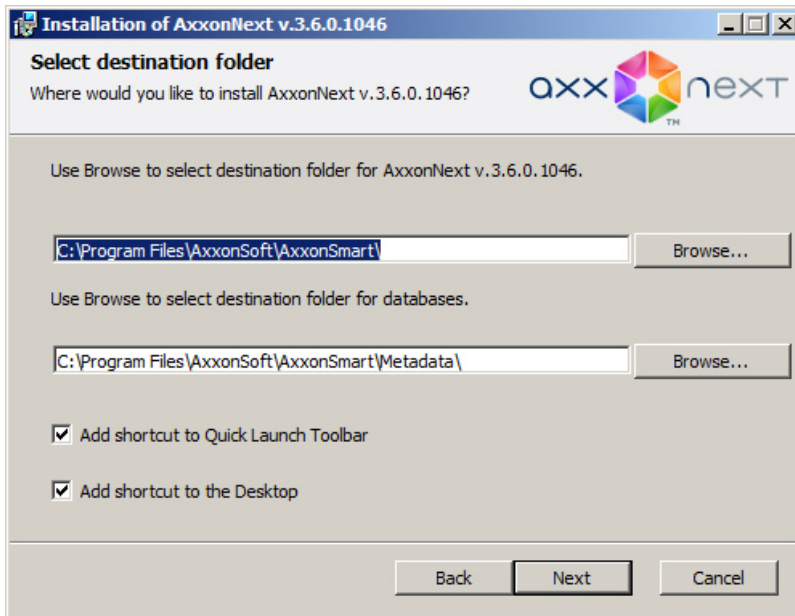

8. Select a user account in the file browser:



**Note**

The file browser helps to navigate through the Server's file system (such as when choosing disks for log volumes). The user account for the Windows file browser will be created with administrator privileges.



**Attention!**

After installation of Axxon Next, make sure that a file browser account has been created in Windows and belongs to the Administrators group.

- a. Create a new account; the default name selected will be AxxonFileBrowser.
- b. Select the LocalSystem account, which is used by the service control manager. This completely trusted account has extensive privileges on the local computer, and has the right to access the network as the machine.
- c. Create a new account; the user name and password are set independently.



9. Create a new Axxon Domain with the name **Default** (for the definition of an Axxon Domain see [Appendix 1. Glossary](#)). If you want to add the computer to an Axxon Domain at a later time, select **Server will be manually added to already existing Axxon-domain later**. Click the **Next** button.



**Note**

When reinstalling *Axxon Next*, you have the option of using the previous Axxon Domain (select **Use existing configuration**)

**Note**

Using the same Axxon Domain name does not guarantee that the Servers will be in the same Axxon Domain. To place all Servers into one Axxon Domain, you must use the Axxon Next interface to add each Server to the necessary Axxon Domain. Axxon Domain configuration is described in detail in the section titled [Configuring Axxon domains](#)

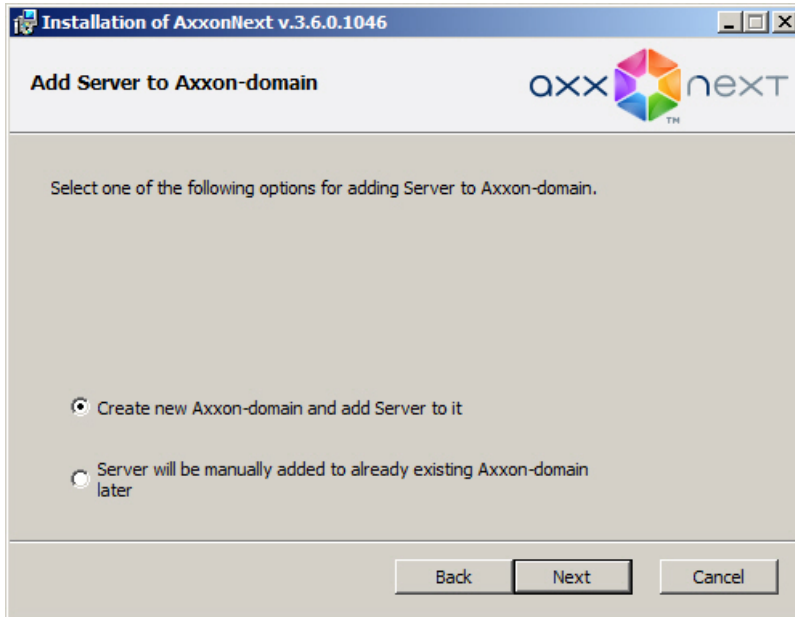

A dialog box then appears, showing the installation parameters corresponding to the selected type of installation.

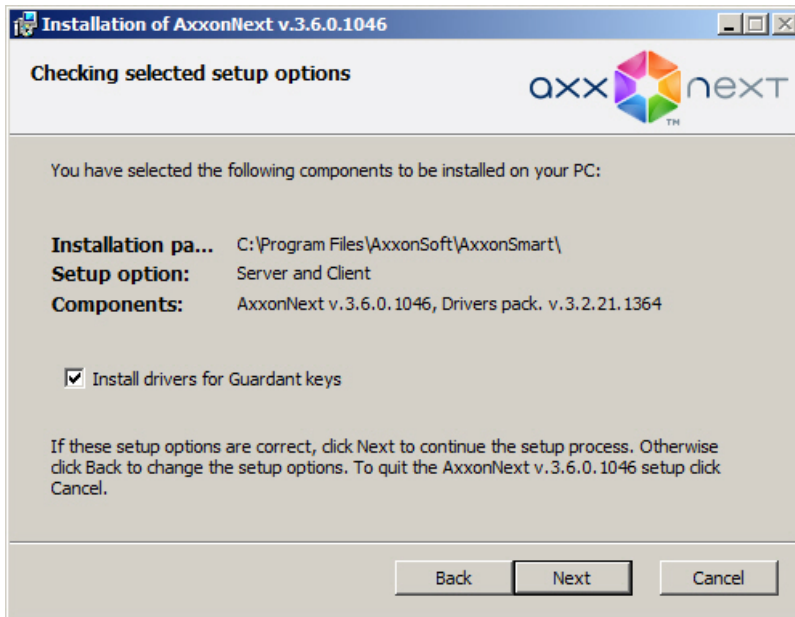

- To install the driver for Guardant hardware dongles, select the corresponding check box. Verify the selected installation options and click the **Next** button to start installation of Axxon Next. The software pre-requisites are installed first, including the PostgreSQL 9.2.2 database server. If an earlier version of PostgreSQL is installed on the computer, it is updated to version 9.2.2 in the background. A new log database is created automatically, with the name "ngp", user name "ngp", and password "ngp".

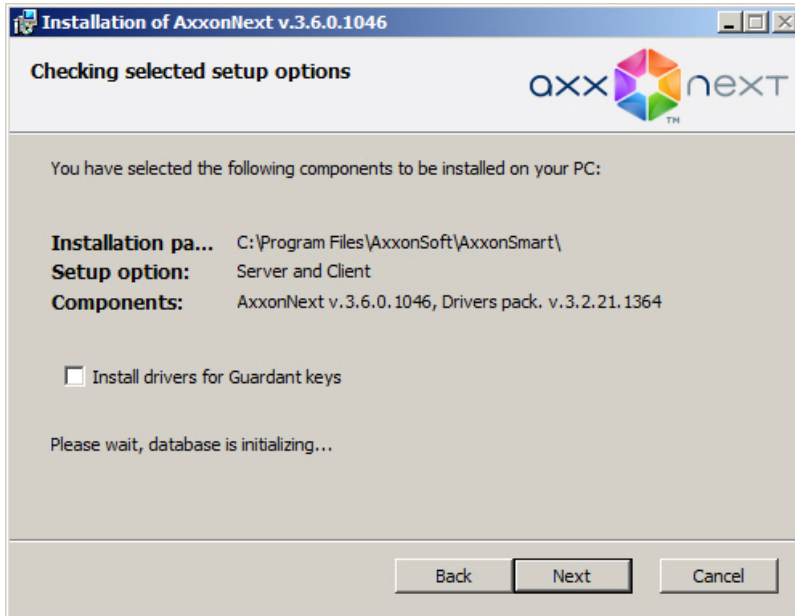

Then Axxon Next itself is installed.

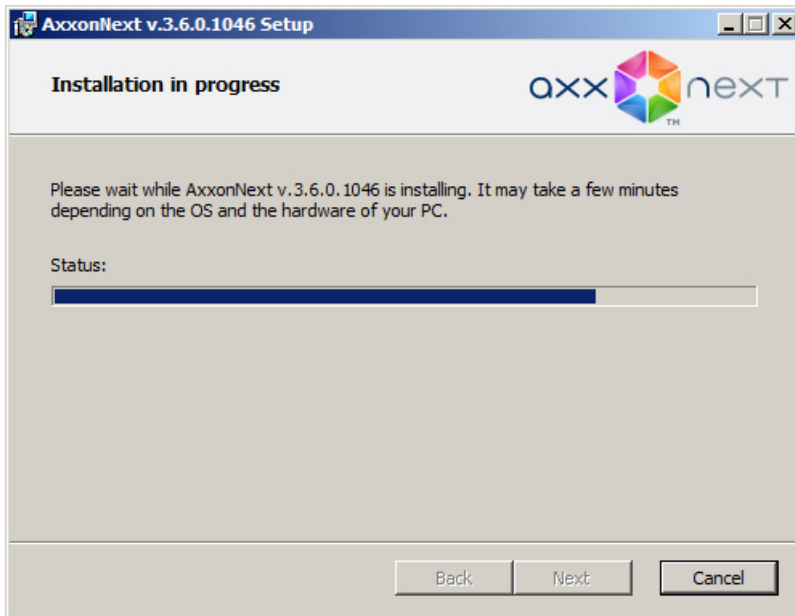

A message indicating the completion of Axxon Next installation will appear in a new dialog box.

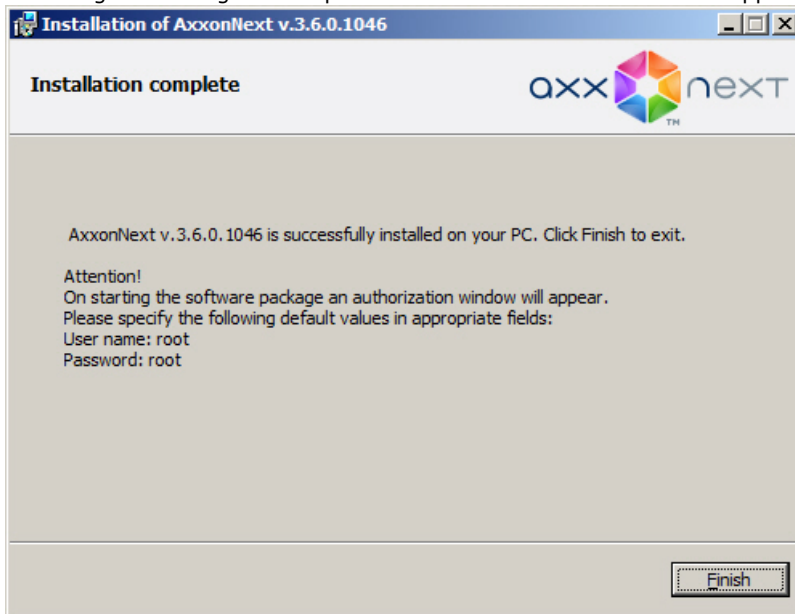

11. Click **Finish** to confirm completion of the installation.

Installation of Axxon Next is now complete.

## Repairing Installation

A repair installation is used to re-install all components of the Axxon Next software package. To start a repair installation, launch the Axxon Next software installer from the installation CD without removing the previous version of the program.

**Note**  
To ensure that Axxon Next is re-installed correctly, all related applications should be closed before starting the repair installation

To run a repair installation of the Axxon Next software, you must perform the following steps:

1. Insert the Axxon Next installation CD into the CD-ROM drive. A dialog box will display the disk contents.



2. Run the Setup.exe file.
3. Click **Next** on the setup wizard's welcome screen.

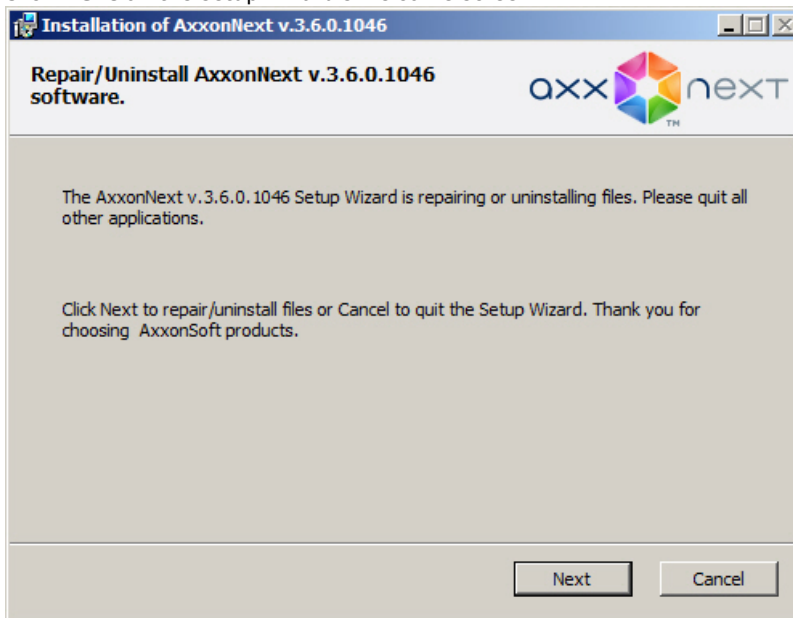

4. A dialog box will appear, allowing you to choose an operation.

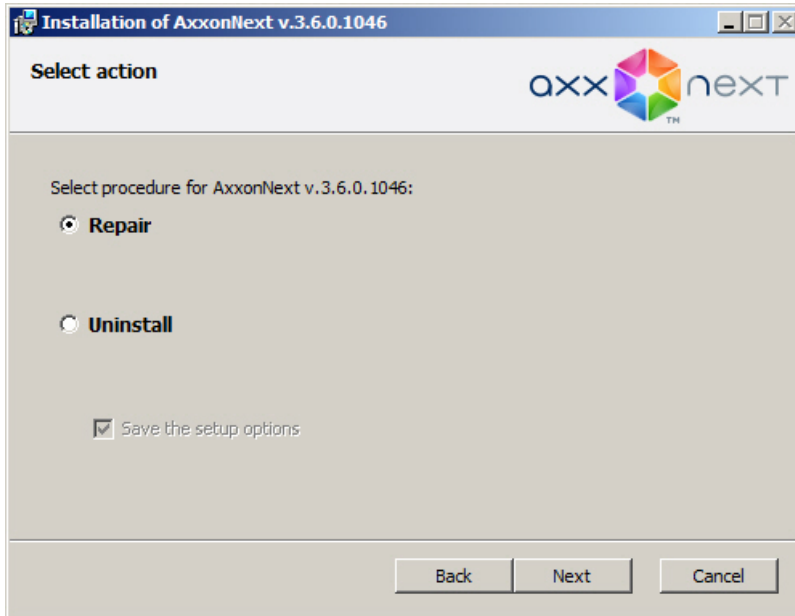

5. Select the **Repair** option and click **Next**.

A dialog box will appear, showing the Axxon Next repair process.

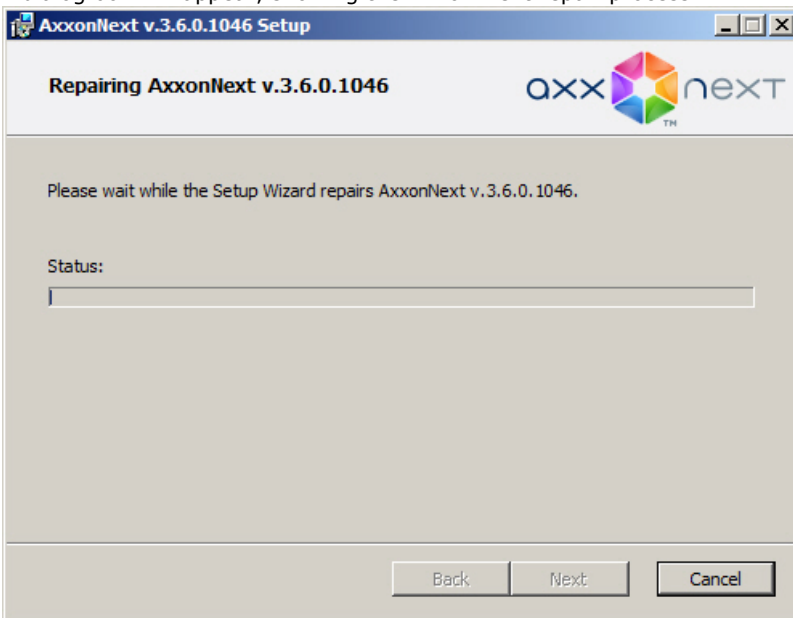

A dialog box will appear, indicating the completion of the repair process. Click **Finish**. Repair of Axxon Next is now complete.

## Removal

The Axxon Next installation program can also remove the software. Use this option when you need to remove all components of Axxon Next from your computer.



### Note

All related applications should be closed before beginning removal of the Axxon Next software

You can run the Axxon Next uninstaller via one of the following methods:

1. from the **Start** menu
2. using **Add or Remove Programs** in the Windows control panel
3. By starting the executable file named setup.exe, which is included with the installed version of the product.

When you do this, the setup wizard's welcome screen appears. To remove Axxon Next, you must observe the following procedure:

1. Click **Next** on the setup wizard's welcome screen.

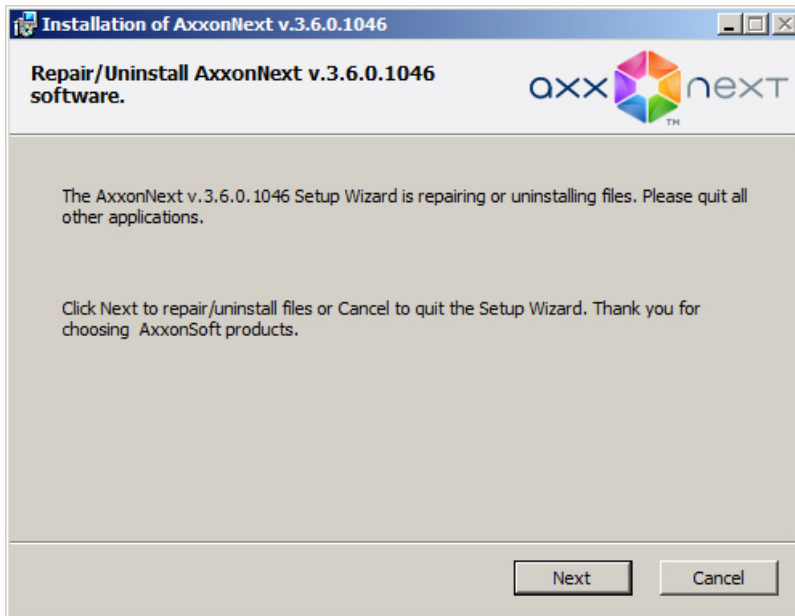

A dialog box will appear, allowing you to choose an operation.

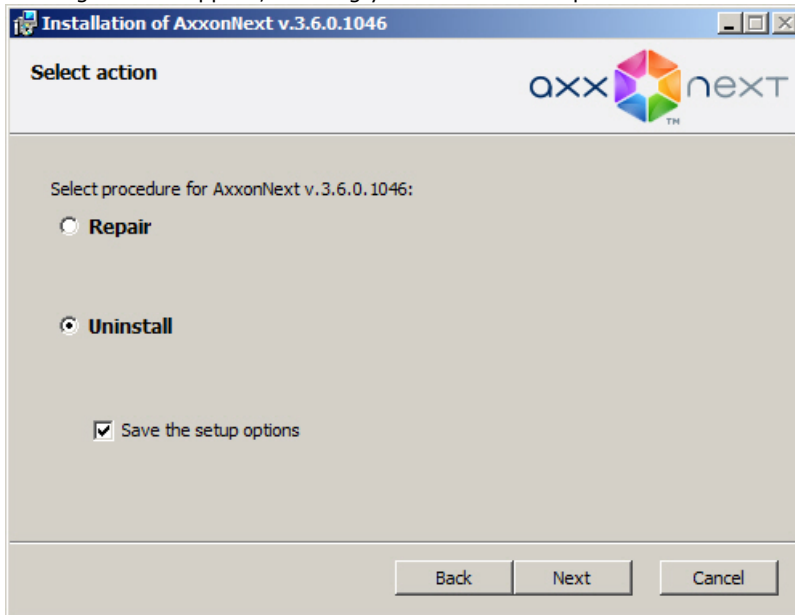

2. Select **Remove**.
3. To save your Axxon Next settings in a database, select the **Save configuration** check box. This option may be useful when updating the product.
4. Click **Next**.

A dialog box will appear showing the Axxon Next removal process.

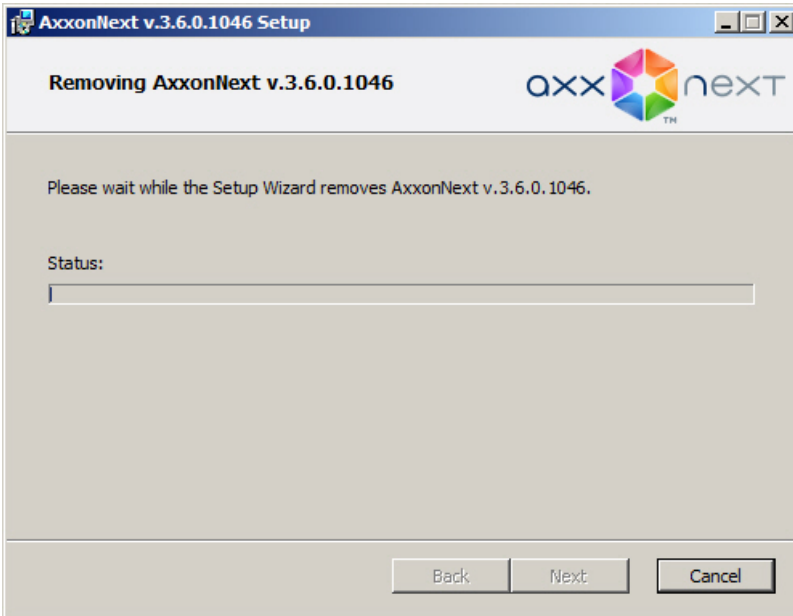

A dialog box will appear, indicating the completion of the removal process. Click **Finish**. Removal of Axxon Next is now complete.



**Note**

To completely remove Axxon Next, use the Windows Control Panel to remove the following software:

1. PostgreSQL.
2. AxxonSoft Situation detectors.ItvDetectorPack.
3. Axxon Driver Pack.

## Update



**Attention!**

An update can be applied only to the most recent previous version of the product. For example, *Axxon Next* version 3.0 cannot be updated directly to version 3.5; it must be updated to version 3.1 first.



**Attention!**

It is strongly recommended to not roll back installations of a previous version of the product.

For example, if *Axxon Next* version 3.5 is installed, do not roll back to version 3.1

If you need to install a new version of the *Axxon Next* software package but want to keep your existing configuration and databases, complete the following steps:

1. Remove the currently installed version of *Axxon Next* (see the section titled [Removal](#)).



**Note**

It is not necessary to remove *Axxon Next* components when updating the *Axxon Next* VMS (PostgreSQL, AxxonSoft Situation detectors.ItvDetectorPack, Axxon Driver Pack). If newer versions of these components are found in the new version of the product, they will be installed automatically.

2. Install the new version of *Axxon Next* in the same folder where the older (removed) version had been installed. You can place your databases in any folder you want. When installing the new version, select the **Use the current database** radio button (for the log and object trajectory databases) in the **Select database** window.

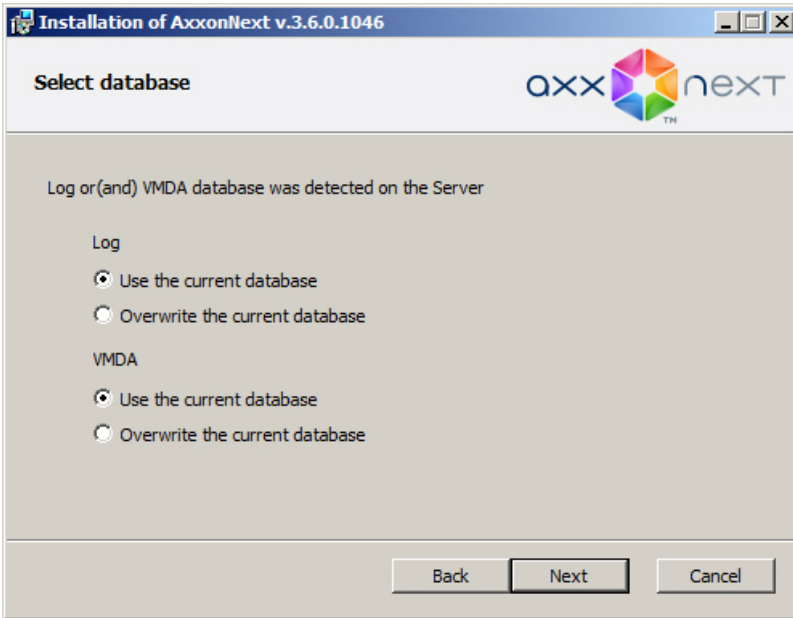

**Note**

If you do not need to retain existing databases, select the **Overwrite the current database** radio button

# Licensing of the software product

## Axxon Next license types

Upon installation, the software will be launched in demo mode. The system will operate in demo mode from 8:00 AM to 6:00 PM.

The Axxon Next software package must be activated in order to utilize the full functionality of the security system. You can activate the software by distributing an activation key on the system.

Data on all the types of Axxon Next licenses is presented below.

Type of license	Number of servers in the system	Number of video channels per server	Archive volume	Additional features	Cost
Demo mode from 8 AM to 6 PM	Unlimited	Unlimited	Unlimited (limited only by available disk space)	Forensic Search Information boards OpenStreetMap	Free
<i>Axxon Next Free Version</i>	1 (fixed)	16 (fixed)	1 terabyte	-	Free
<i>Axxon Next</i>	Unlimited	Unlimited	Unlimited (limited only by available disk space)	Forensic Search (as needed) Line crossing detection Information boards OpenStreetMap	Please contact AxxonSoft to inquire about the price

*Axxon Next Free Version* can be upgraded to *Axxon Next*. Upgrades must be purchased. Upon upgrade, you can use unlimited storage. Also, if you upgrade, you can purchase additional licenses for Forensic Search in archive and for servers and/or video cameras.

In the case of an *Axxon Next* license, an upgrade can be obtained for increasing the number of servers and video cameras in the system or adding the Forensic Search capability.

**Note**

When you upgrade your license, you cannot reduce the number of video channels

Information about the type of license you are using is displayed in the server properties in the **Product Type** field: **Axxon Next Free Version** or **Axxon Next**.

# Licensing methods

There are two licensing methods for Axxon Next:

1. License file only

The license file contains data on basic hardware configuration (motherboard, processor, hard disk, video adapter, RAM, and network card) of all Servers. If you change any 2 of the basic hardware components, your license will be invalid. For example, this is the case when you change both CPU and motherboard. However, changing a graphics card or upgrading RAM will not affect the license.

This is why when working with Axxon Next you should bear in mind the following:

- a. The activation request should be sent from the computer that will host the Axxon Next Server.
- b. You can upgrade your license only if you retain the initial basic hardware configuration of all the Servers.
- c. It is not possible to transfer a license from one computer to another.

2. License file + Guardant dongle.

this method allows replacing server hardware and transferring the license to another computer. To activate Axxon Next via this method, contact AxxonSoft to receive a license file and Guardant dongle. If you already have a Guardant dongle, you can perform activation yourself. To do so, connect the Guardant dongle to the computer that you wish to activate and perform the standard activation steps.



**Note**

If you install virtualization products such as VirtualBox, VmWare etc. , this may affect the license. Should you encounter this problem, you are advised to uninstall all virtualization products or apply for a new license file

## Product Activation Utility

License activation for the Axxon Next software package is carried out through the product activation utility.

You can launch the product activation utility from the Windows **Start** menu: **Start -> All Programs -> Axxon Next -> Utilities -> Program Activation.**



**Note**

The product activation utility program file LicenseTool.exe is located in the folder <Directory where Axxon Next is installed>\Axxon Next\bin\

Then you must select the name of one of the Axxon Domain servers to which the license file will be applied (the file is applied to all Axxon Domain servers launched at the moment of activation) and connect to the system, under an administrator's user name and password, to continue the activation process.



When the utility has loaded, its main will be displayed.

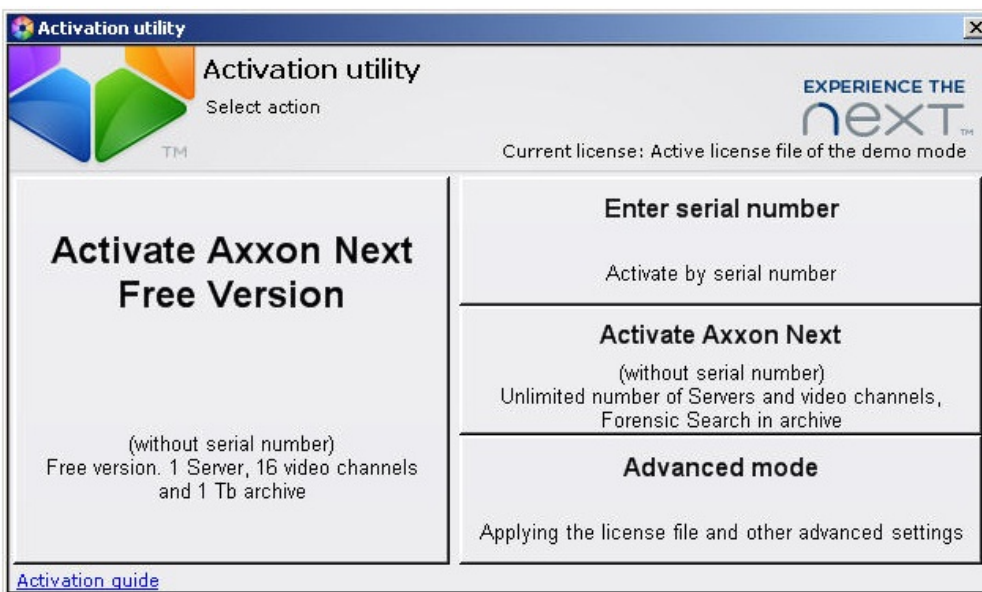
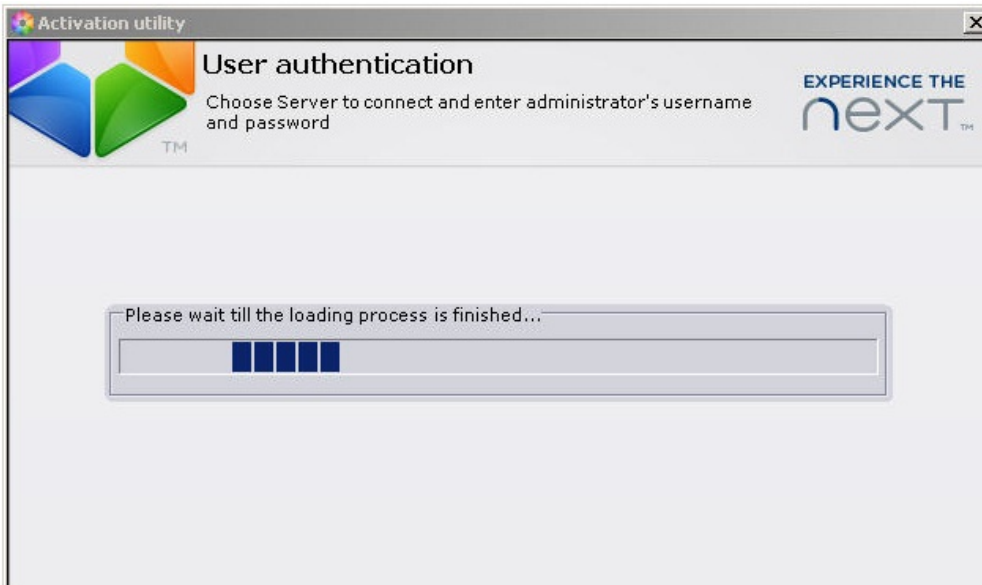

## License Activation

To activate Axxon Next, please refer to the document titled [Activation Guide](#), which presents step-by-step instructions on activating, updating and upgrading Axxon Next .

It is also recommended that you use the prompts displayed in the product activation utility's dialog boxes .

# Launching and Closing the Axxon Next Software Package

[Play corresponding video](#)

## Startup

### Starting a Server

The *Axxon Next* Server is started automatically when the operating system starts.

If a Server's operation was stopped, you must complete one of the following actions to restart the Server:

1. Restart the system
2. Select **Start** -> **All Programs** -> **Axxon Next** -> **Start Server**
3. Start NGP Host Service

## Starting an Axxon Next Client

The Axxon Next client can be started manually using the **Start** menu, which is intended for launching user programs in Windows. To start working with the software, perform the following steps:

1. Select **Start -> All Programs -> Axxon Next -> Axxon Next**

**Note**  
The Axxon Next software package program file AxxonNext.exe is located in the folder <Axxon Next installation folder>\Axxon Next\bin\

The Axxon Next client will then launch and an authorization window will appear

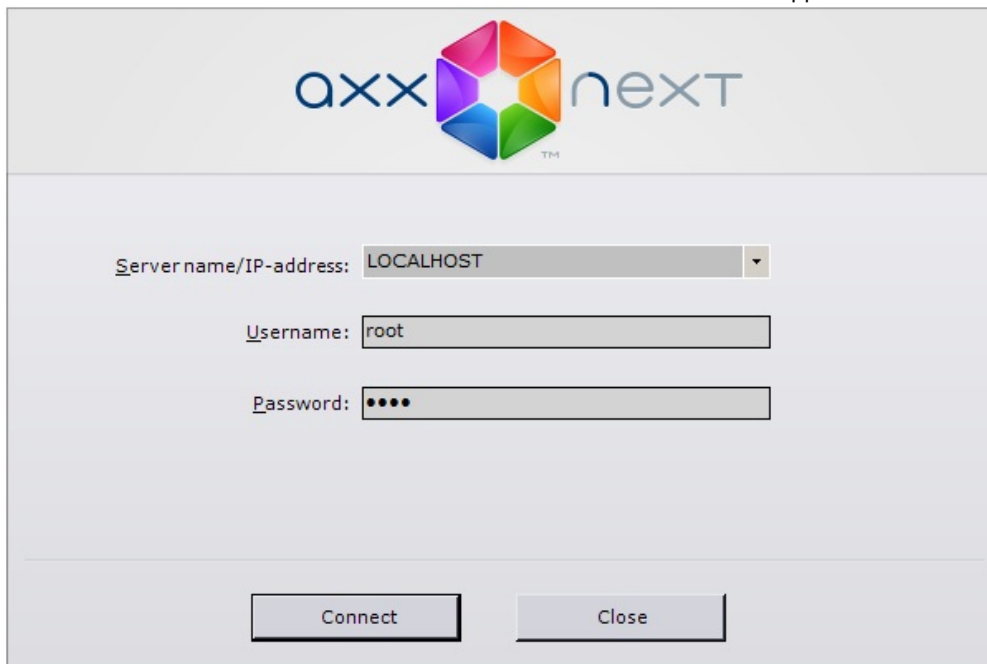

2. Enter the user name and password and click **Connect**.

**Note**  
If the software is accessed by a remote user, the NetBIOS name or IP address of the computer with which the connection is established should be indicated in the **Computer** field

**Note**  
The first login to the system is done with the user root, which has administrator permissions. Enter root in the **User Name** and **Password** fields. The administrator then needs to configure the system for multi-user access described in detail in the section titled [Creating and Configuring the Role and User System Objects](#)

**Attention!**  
If a remote user is accessing a Server, the version of the Server and the version of the user's Client must be the same. The installed versions of the Drivers Pack must be the same as well.

If authorization is successful, a video surveillance monitor will be displayed on the screen.



#### Note

If Axxon Next is launched in demo mode, then after you enter the authorization parameters, a message to this effect will appear (see the section [Demo mode notification](#))

If the Server to which Axxon Next is connecting does not belong to any Axxon Domain, after the **Connect** button in the authorization window is clicked, a message is displayed.

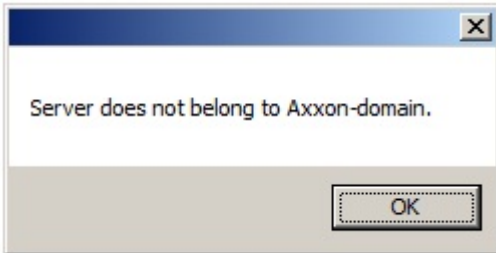

To connect to the Server, you must either create a new Axxon Domain based on the server or add the Server to an existing Axxon Domain.

If you choose the first option, click **OK** in the message and follow the instructions given in the section [Creating a new domain](#). For the second option, click the  button and follow the instructions given in the section [Adding a Server to an existing Axxon Domain](#).

## Running multiple Axxon Next Clients

You can run multiple Axxon Next Clients simultaneously on a single computer in order to connect to different Servers.

In this case, you must start Clients with the additional parameter **monitor N**, where N is the number of the monitor on which the Client is to be started.



#### Attention!

The maximum number of running Clients is limited to the number of connected monitors that support the minimum required resolution (see [Limitations of the Axxon Next Software Package](#))

To run multiple Clients:

1. On your desktop, create a number of Client shortcuts equal to the number of connected monitors.
2. In the properties of each shortcut, in the **Target** line, add the additional parameter **monitor N**.

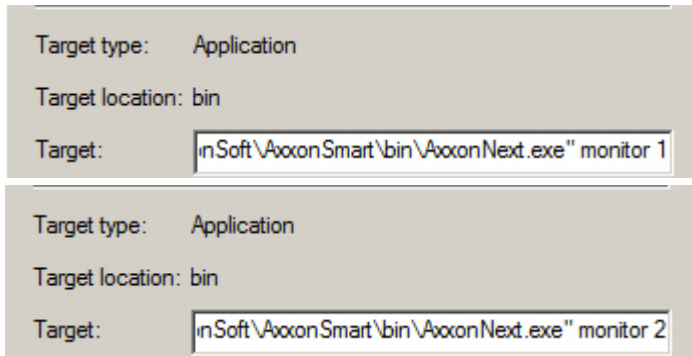

3. Start the Clients by using the shortcuts.



**Note**

If a Client is started in window mode (see [Configuring the Client screen mode \(full screen or window\)](#)) and moved to another monitor, the situation changes: Clients will be started on the specified monitors even if a Client is already running on one or more of them.

## Demo mode notification

If activation has not been completed, *Axxon Next Free Versions* works in demo mode.

The system will operate in demo mode from 8:00 AM to 6:00 PM. The software has no other limitations, functional or otherwise, when running in demo mode.

The different types of demo modes are presented in Table.

Type of demo mode	Conditions	Axxon Next operation
Active	Axxon Next can be started between the hours of 8:00 AM and 6:00 PM	<i>Axxon Next</i> works without limitation
Inactive	Axxon Next started outside the hours of 8:00 AM and 6:00 PM	<i>Axxon Next</i> does not work

If a Client is connected to an Axxon Domain in which there is at least one Server running in demo mode, an appropriate message is displayed, along with a list of Servers in the Axxon Domain and their types of licenses.



**Note**

The notification is displayed after successful authorization

If an Axxon Domain includes at least one Server running in active demo mode, you will be given the option to continue working **(2)** or start the activation utility **(1)**.

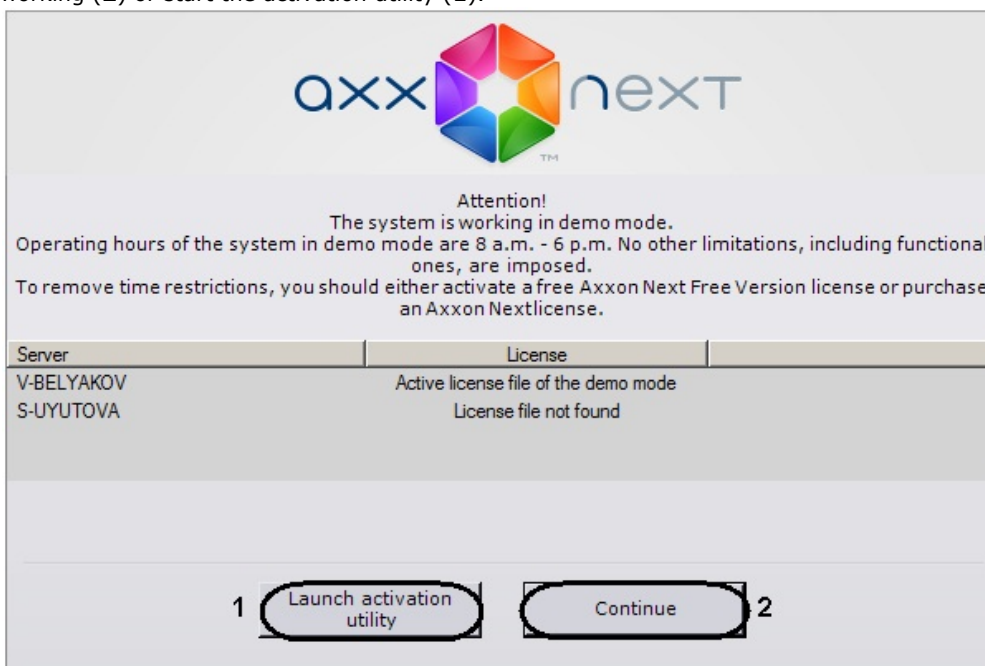

If all Servers in the Axxon Domain are running in inactive or expired demo mode, you will be given the option to launch the activation utility or close the Client.

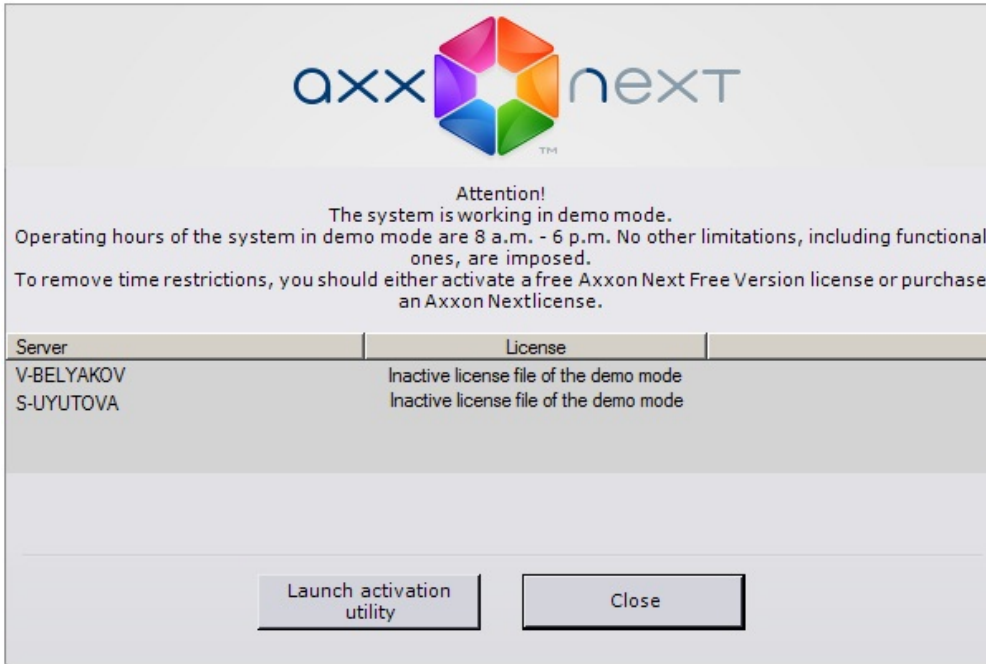

## Shutdown

### Shutting down an Axxon Next Client

Before closing Axxon Next, you need to exit the user interfaces. To do this, perform one of the following:

1. Click the  button located in the top-right corner of the Axxon Next dialog box.

**Note**  
If the client is opened in full-screen mode (enabled by default), the !.jpg! is not displayed. In this case you can exit the user interfaces using actions 2 and 3



2. In the **Settings** tab, click the  button.
3. In the Windows taskbar notification area, in the context menu of the Axxon Next icon, select **Close window**.

When you perform one of these actions, the authorization window will appear. To close Axxon Next (completely exit the client), click the **Close** button.

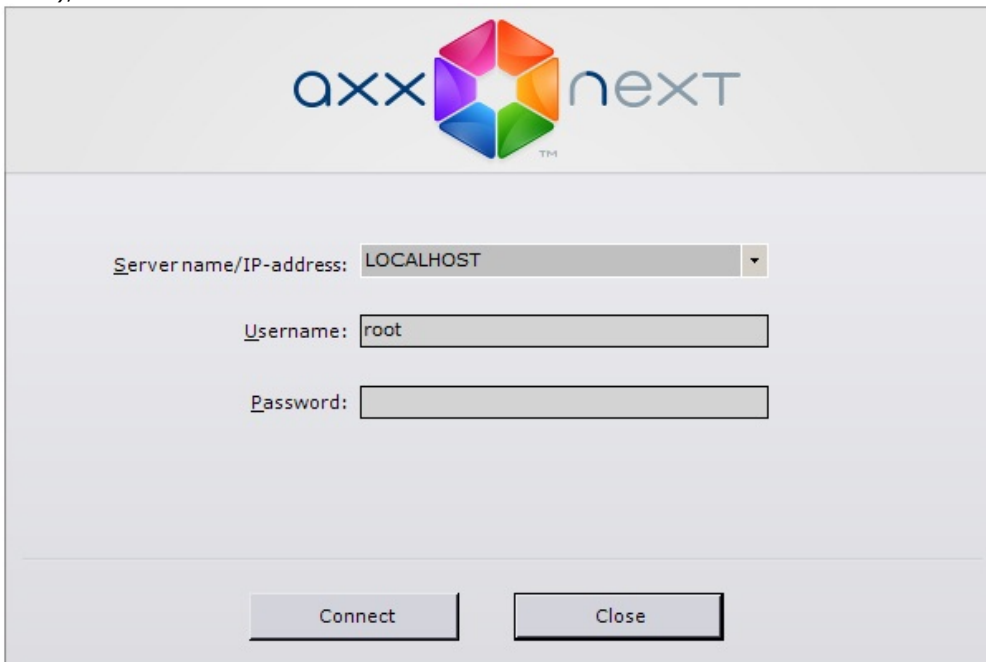

## Shutting down a Server

To shut down an *Axxon Next* Server, complete one of the following actions:

1. Select **Start -> All Programs -> Axxon Next -> Shut down Server**
2. Stop the NGP Host Service.

## Switching Users Quickly

You can switch *Axxon Next* users quickly without fully exiting the client.

To do this, follow the steps below:

1. Exit the *Axxon Next* user interface (see the section [Shutdown](#)).

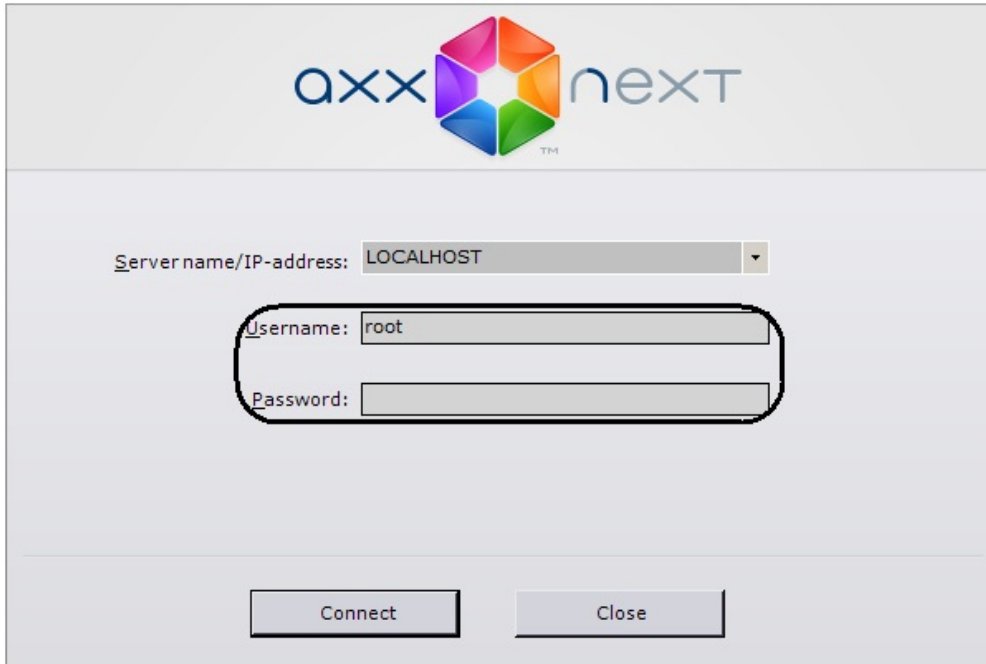

2. When the authorization window appears, enter the user name under which you need to log in and the corresponding password and click **Connect**.

Switching users is now complete.

## Connecting to Another Server Quickly

You can connect to another server without fully exiting the client.

To do this, follow the steps below:

1. Exit the *Axxon Next* user interface (see the section [Shutdown](#)).
2. When the authorization window appears, select the server to which you need to connect the client from the **Computer** list.
3. Enter the user name under which you need to log in and the corresponding password and click **Connect**.

Connection to another server is now complete.

# Configuration of the Axxon Next Software Package

## General Information on Configuring System Objects

### Procedure for Configuring System Objects

System objects form the basis for configuring the *Axxon Next* software package; you can set them up in the **Devices** section of the **Settings** tab.

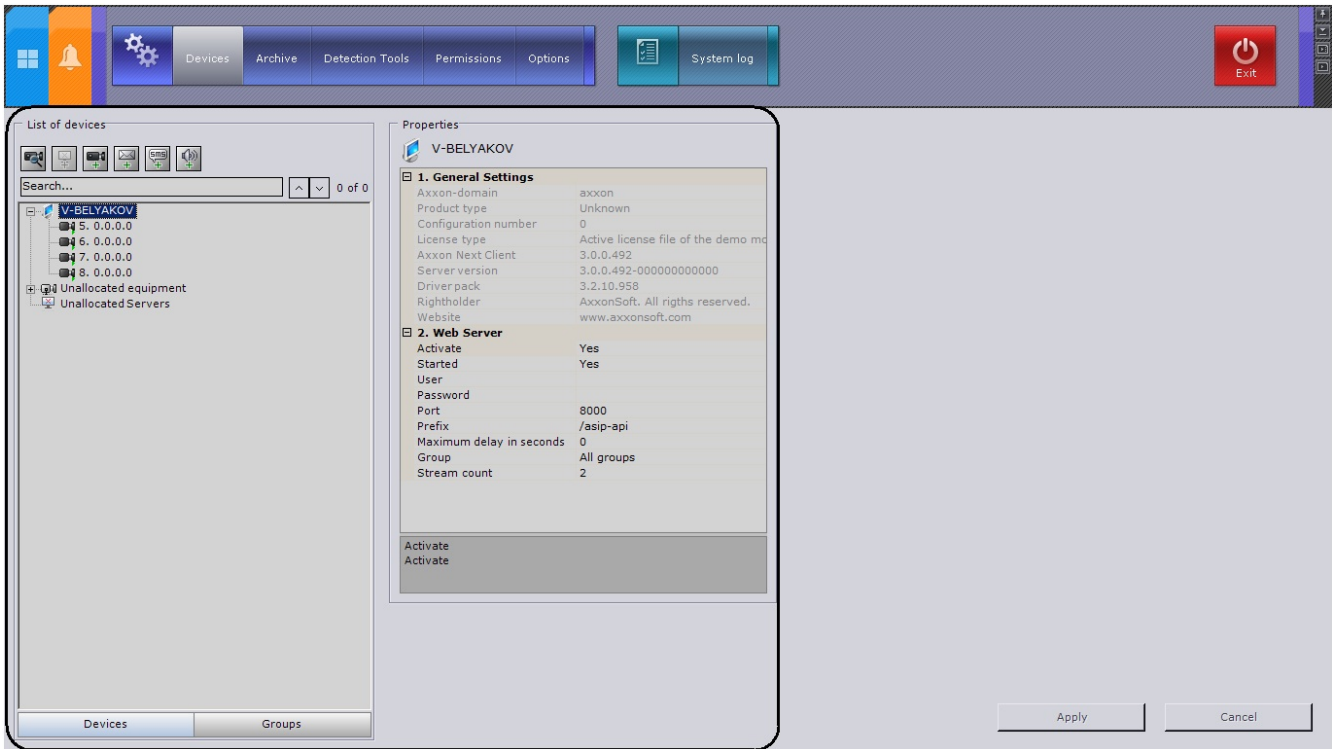

Functions such as identifying devices physically connected to a Server and managing those devices, creating users with varying permissions, and creating rules and automatic responses make up just a portion of what the user can do by creating and configuring system objects.

The procedure for working with system objects varies slightly depending on their type, but generally you should adhere to the following sequence of actions:

1. Create an object.
2. Configure its parameters.
3. Save changes.
4. Edit the values of parameters.
5. Save changes.
6. Delete the object.

Some system object parameters have a set range of values, in which case you must select the appropriate value from a list. Other parameters serve to display information, while yet others must be set manually according to the recommendations in the parameter's description.

**Note**

As a rule, the parameter description is displayed in a special area under the object properties table when the parameter is selected

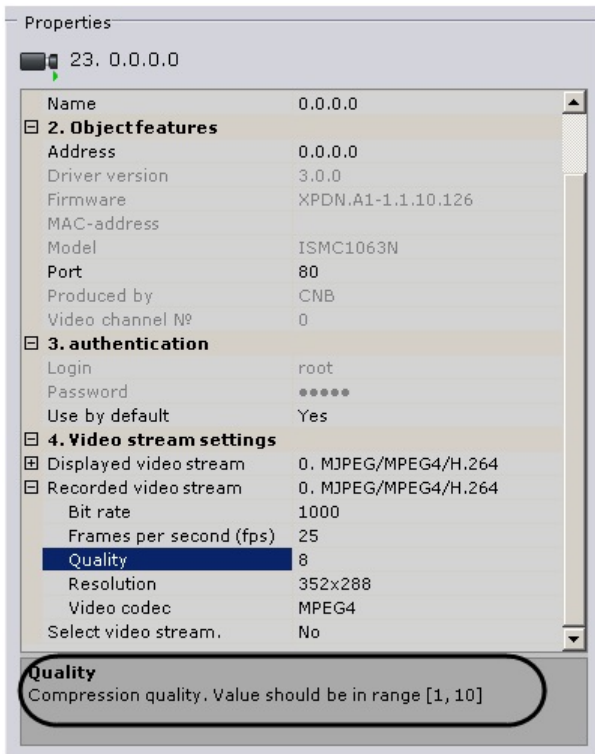

If the description of a parameter is truncated, you can stretch this area above the upper border.



As evident from the sequence listed above, make sure to save any changes made during configuration by clicking the **Apply** button. After you click the button, a progress bar will indicate that the settings are being applied. You can resume working with the system after the process completes.

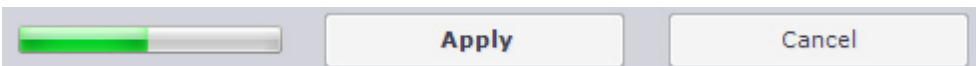

Before you click the **Apply** button, the changes may be cleared using the **Cancel** button. Otherwise the changes will be applied without having to restart the software.

## List of Servers for an Axxon Domain

All servers under the same Axxon Domain as the server you connected to are displayed in the list of devices.

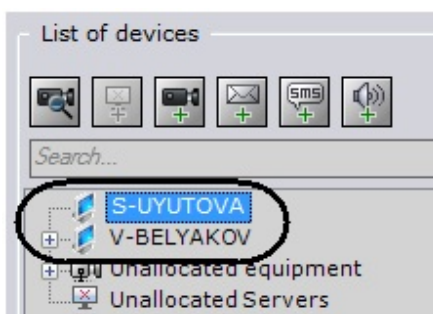

You can configure all Axxon Domain servers from any Client workstation, provided that you have the appropriate permissions (see the section [Creating and Configuring the Role and User System Objects](#)).

## Searching for Unallocated Servers and Hardware

Unallocated Servers (that is, servers that do not belong to any Axxon Domain) and IP devices are shown in the system

after you perform a device search. To start a search, click the  button.

**Note**

Since multicast packets are used for device search, the search results may not contain the Servers and devices from other subnets

Unallocated servers found are displayed in the Unallocated Servers list. Please refer to the section [Adding a Server to an existing Axxon Domain](#) to find out how to add them to an Axxon Domain.

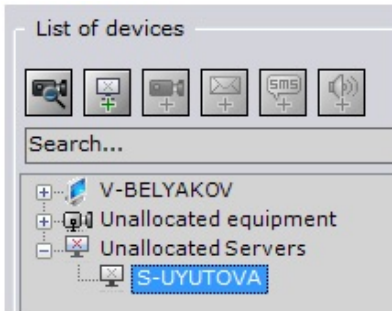



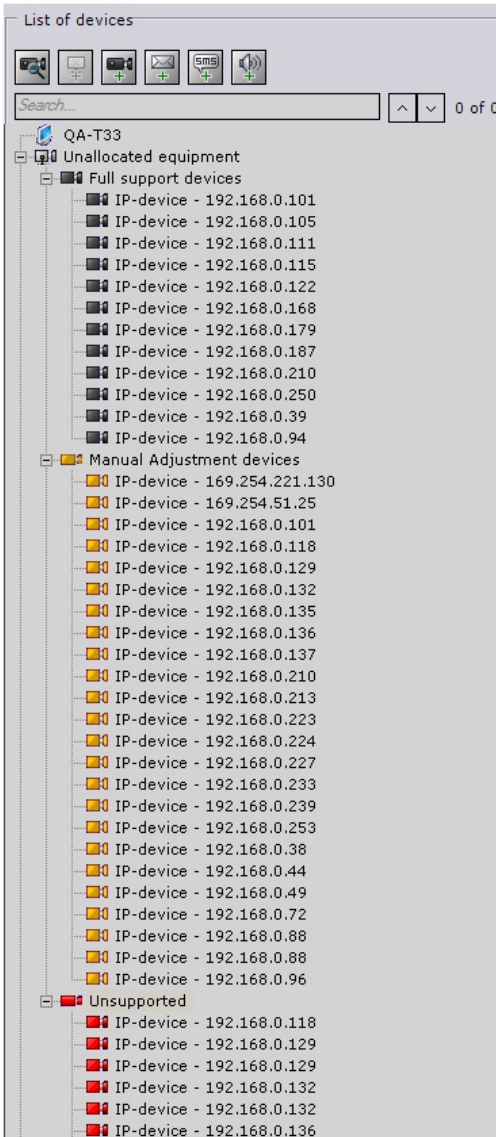

Found devices are sorted by group (based on status) in the **Unallocated Equipment** list.







**Note** To view more detailed information about a device (manufacturer, model, firmware, etc.), select its corresponding line in the list

Icons for groups and video cameras will be in different colors depending on the status of the detected devices.

Color of video camera icon	Description
----------------------------	-------------

Black 	The device's manufacturer, model, and firmware have been definitely determined; it can be added to the list of devices on the server as is.
Yellow 	When adding the device to the list of devices on the Server, check the manufacturer, model, and firmware version used.
Red 	The device's manufacturer, model, and firmware have not been determined. Video cameras must be manually added to the Server's equipment list (with the help of the tool  ).

The desired unallocated equipment marked with  and  must be linked to the Server, after which it will be displayed in the list of devices on the Server and will be accessible for further configuration. Devices marked with  can be linked to a Server with the  tool by selecting the server in the object tree.

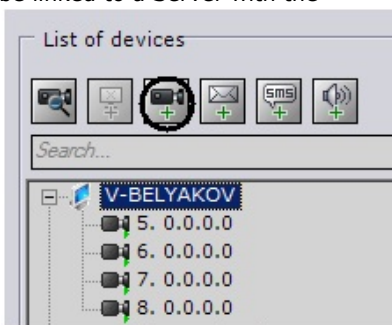

### Attention!

Compatibility of devices marked  with Axxon Next is not guaranteed





If you remove a server from an Axxon Domain, the server automatically joins the **Unallocated Servers** list, if the current Client was connected to another server. If the current Client was connected to the removed Server, the user interfaces will close.

When a device is deleted from the list of devices on a server, it is automatically placed in the **Unallocated Equipment** list.

Devices are listed under **Unallocated Equipment** without verification of their presence on the network. To refresh these

lists, you must launch a device search (by using the  button).

## Creating Device Objects Manually

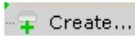
You can create objects in Axxon Next either by using the , , , ,  tools located above the object tree or by using the  link, depending on the object type. You can then configure the objects and save changes.



### Note

If the settings of a newly created object are not saved, the  icon will appear on the tab, literally indicating that the changes to the tab have not been saved. Then, when you are exiting the program, a message will appear, asking whether you want to exit without saving changes

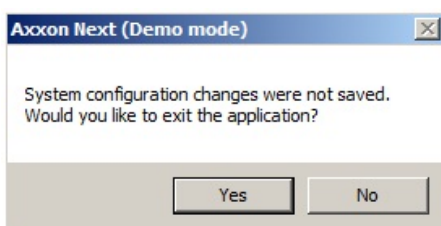

## Object search

Axxon Next allows you to search for objects in the objects tree using only part of their name. An object search can be performed on all tabs under **Devices**.

To search for objects, complete the following steps:

1. Select the tab containing the object tree that you need to search

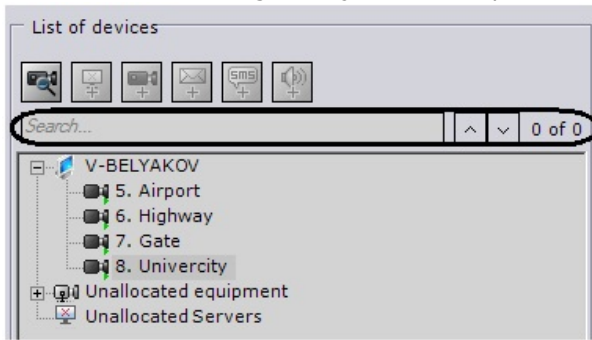

2. Enter the full or partial name of the object in the **Search...** box.

**Note**  
Search is not case-sensitive

**Note**  
A search can also be run based on object ID

The search starts automatically once you enter something in the box. When the search is complete, you will see the number of objects found in the tree, along with the currently displayed search results highlighted in beige.

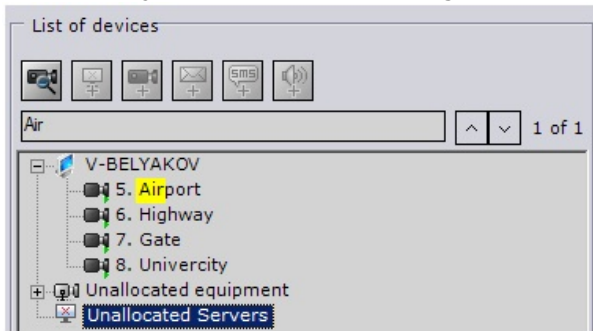

The parts of names corresponding to the characters you entered will be highlighted in yellow on the found objects.

**Note**  
If a found object is located in a collapsed branch of objects, the branch will be highlighted in yellow

To move between search results, use the  buttons.  
The search results rotate in a loop; moving from the last object takes you back to the first object.

**Note**  
If you move to an object located in a collapsed branch, the branch will automatically expand

## Configuring Axxon domains

A distributed system based on the Axxon Next software package is created within an Axxon Domain, i.e., a selected group of Axxon Next Servers.

When configuring Axxon Domains, the following operations are used in the necessary combinations:

1. Creating a new domain
2. Adding a Server to an existing Axxon Domain
3. Excluding a Server from the current Axxon Domain

To configure Axxon Domains, you must have the appropriate permissions (see the section [Creating and Configuring the Role and User System Objects](#)).

This section gives step-by-step instructions for each operation used in configuring Axxon Domains, and then describes typical instances of their use.

## Play corresponding video

# Axxon Domain operations

## Creating a new domain

A new Axxon Domain can be created in one of two ways:

1. During installation of the Axxon Next software package with the Server and Client configuration type (see step 8 of the instructions in the section [Installation](#))
2. When attempting to connect to a Server which does not belong to a domain

In the second case a message will appear, in which you should click **OK** (see also the section [Startup](#)).

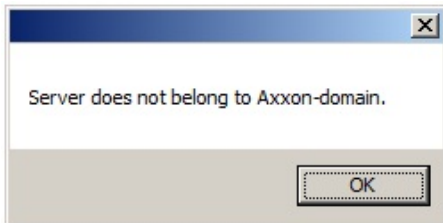

The **Name new Axxon Domain** window will appear. In the **New Axxon Domain name** field, enter the Axxon Domain name to create a new group of computers based on the Server and click **Apply**.

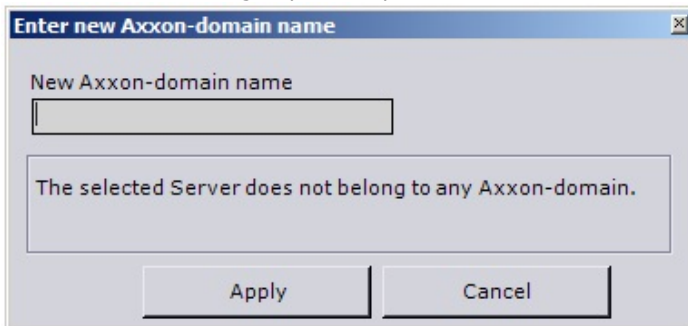

### Attention!

It is not possible to use the above steps to add a Server to an existing Axxon Domain. Assigning the same Axxon Domain name to several Servers does not guarantee that those Servers will be in the same Axxon Domain. Different Axxon Domains can have identical names

This will create a new Axxon Domain based on the Server. The Axxon Next software package will then be launched with the entered authorization parameters (see the section [Startup](#)).

## Adding a Server to an existing Axxon Domain

A Server can be added to an existing Axxon Domain from any Server within that Axxon Domain.



### Attention!

Only unallocated Servers, i.e., Servers which do not already belong to any Axxon Domain, can be added

There are two ways to add a Server to an Axxon Domain, depending on whether or not it is present in the search results (in the **Unallocated Servers** group).

If a Server is present in the search results, you can use the following procedure to add it to an Axxon Domain:

1. Select the Server in the **Unallocated Servers** group (1).

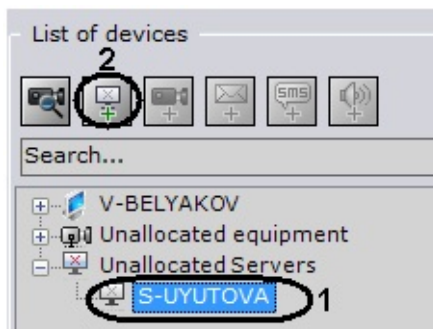

- Click  or select **Add to Axxon Domain** from the context menu after right-clicking on the Server (2).

The Server will then be added to the Axxon Domain from the **Unallocated Servers** group. Since the search for unallocated Servers is conducted using broadcast packets, the results may not include Servers located in a different subnetwork (for example, beyond a router which blocks broadcast packets). In this case the option of manually adding a Server to an Axxon Domain can be useful; this option can be used with all unallocated Servers, including those present in the **Unallocated Servers** group. A Server can be manually added to an Axxon Domain as follows:

- Select the option **Add Server to Axxon Domain** in the context menu of the **Unallocated Servers** group (the menu can be brought up by right-clicking the name of the group).

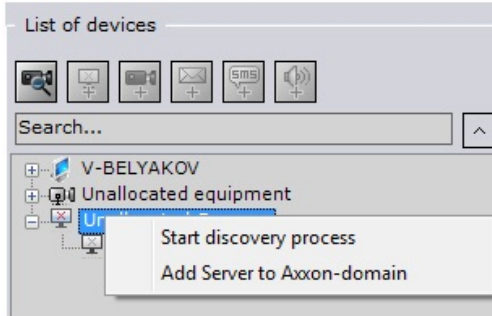

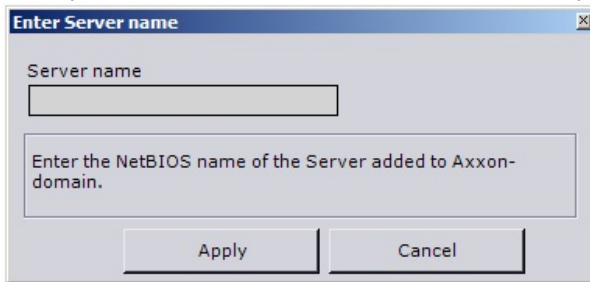

- When you do this, the **Enter Server name** window appears.

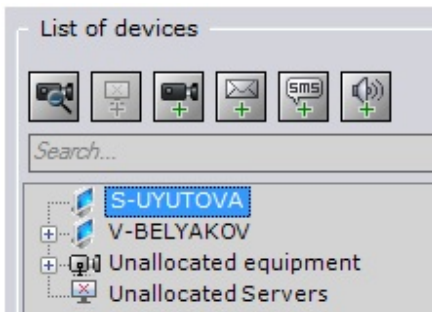

- In the **Server Name** field, enter the NetBIOS name of the Server to be added to the Axxon Domain.
- Click **Apply**.

The Server will then be manually added to the Axxon Domain. After a Server is added to an Axxon Domain using any of the methods described, it will appear in the object tree.



**Note**  
 If a Server is not currently accessible when it is added to an Axxon Domain, it will be displayed in the object tree with the  icon

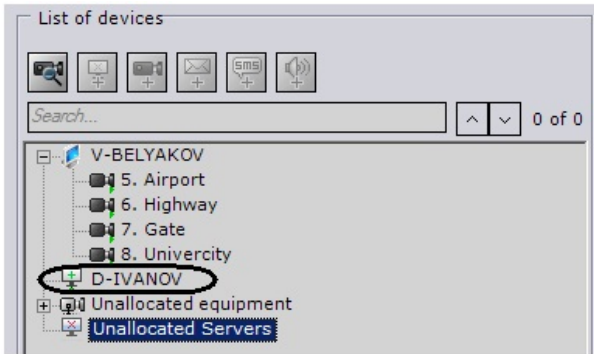

The Server will be added to the Axxon Domain as soon as the Server becomes accessible. To cancel the addition of a Server to the Axxon Domain, you must select **Undo adding Server to Axxon Domain** from the context menu (by right-clicking on the Server name).

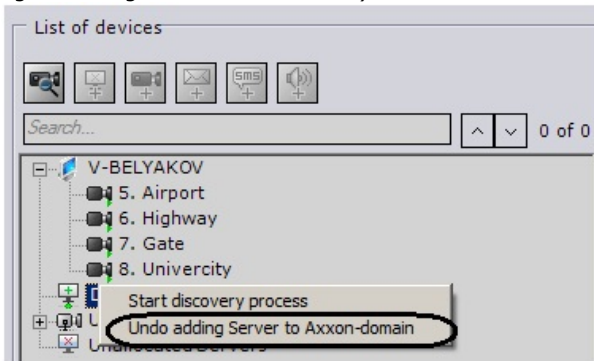

## Removing a Server from an Axxon Domain

Any Server on an Axxon Domain can be used to remove a Server from an Axxon Domain. To remove a Server from an Axxon Domain, you must perform the following steps:

1. Select the option **Remove from Axxon Domain** in the context menu of the Server (the menu can be brought up by right-clicking the name of the Server).

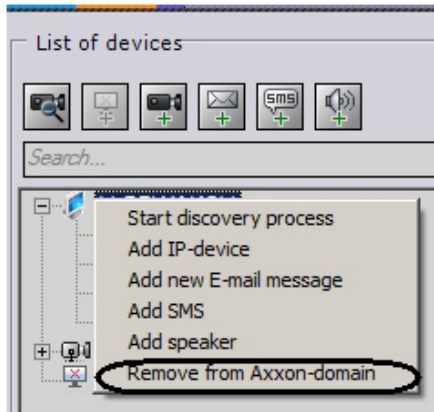

2. In the window which appears, confirm that you want to remove the Server from the Axxon Domain by clicking the **Yes** button.

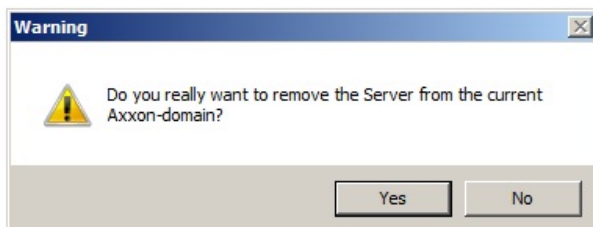

The Server will then be removed from the Axxon Domain. If the current Client was connected to the excluded Server, the user interfaces will be unloaded and the user will be prompted to repeat the authorization procedure for Axxon Next (see the section **Startup**).

## Cases of Axxon Domain configuration

All possible cases of Axxon Domain configuration are, to some degree, a combination of two typical cases. In the first typical case, the Servers for the future Axxon Domain are selected before Axxon Next installation. This case

involves the following steps:

1. Selecting a Server on the basis of which the new Axxon Domain will be created. Installing the Axxon Next software package with the Server and Client configuration type, indicating the name of the new Axxon Domain (see also step 8 of the instructions in the section [Installation](#)).

**Note**  
Any Server in the future Axxon Domain can be selected as the primary Server

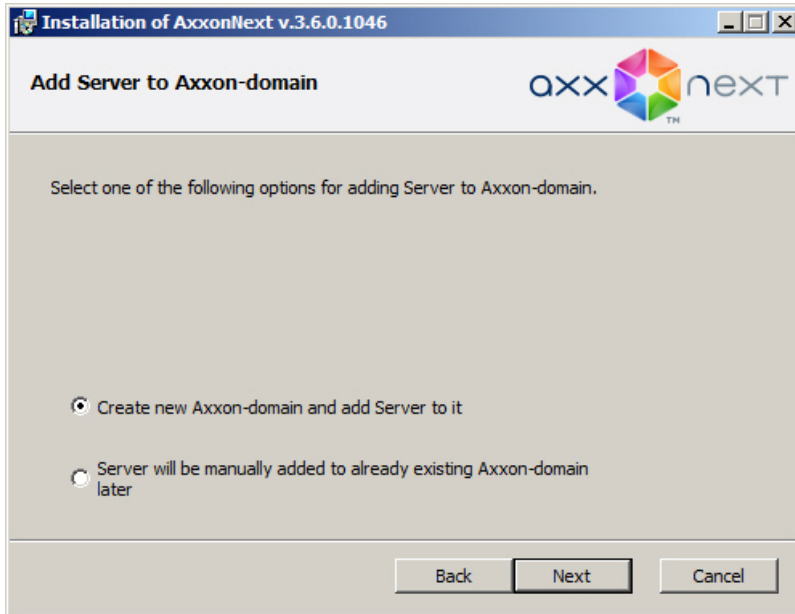

2. Installing the Axxon Next software package with the **Server and Client** configuration type on the other servers of the future Axxon Domain, without adding them to the Axxon Domain (see also step 8 of the instructions in the section [Installation](#)).

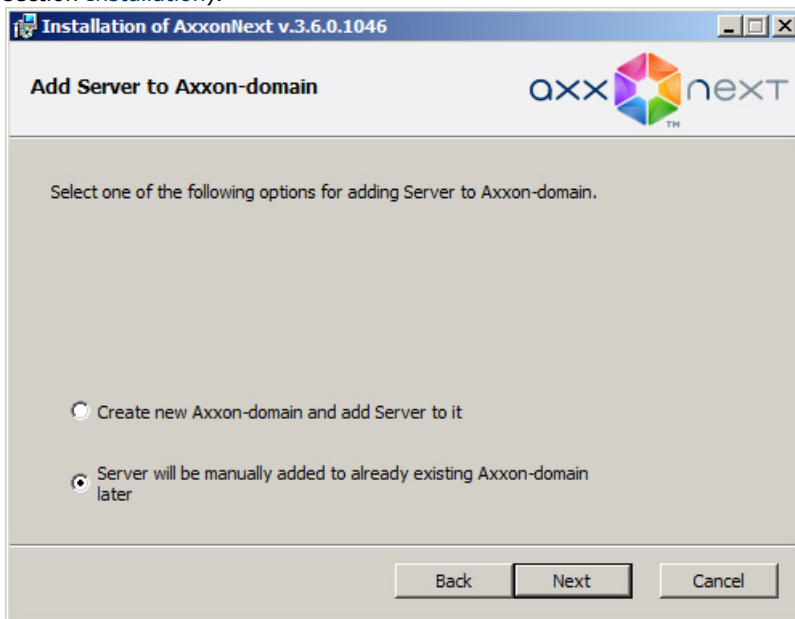

3. Connecting to the primary server.
4. Adding the remaining Servers to the Axxon Domain from the primary Server according to the instructions in the section [Adding a Server to an existing Axxon Domain](#).

In the second typical case it is necessary to add servers which are part of another Axxon Domain to a new Axxon Domain. This case involves the following steps:

1. Excluding all the Servers which are to be added to the new Axxon Domain from their current Axxon Domains, according to the instructions in the section [Removing a Server from an Axxon Domain](#).
2. Naming the new Axxon Domain according to the instructions in the section [Creating a new domain](#), when attempting to connect to one of the Servers excluded in step 1.
3. Adding the remaining Servers to the Axxon Domain from the primary Server according to the instructions in the section [Adding a Server to an existing Axxon Domain](#).

## Preliminary Configuration of Devices

When you launch the Axxon Next software package for the first time, you can perform the following preparatory operations:

1. Selecting IP devices to register as objects.
2. Configuring a default archive for selected IP devices.

**Note**

A default archive is one in which records are made when an operator initiates an alarm

To do this, click **Yes** in the **IP device configuration application** dialog box (1).

**Note**

To skip the preparatory stage when launching Axxon Next, click No (2)



When you do this, the IP device configuration application will launch.

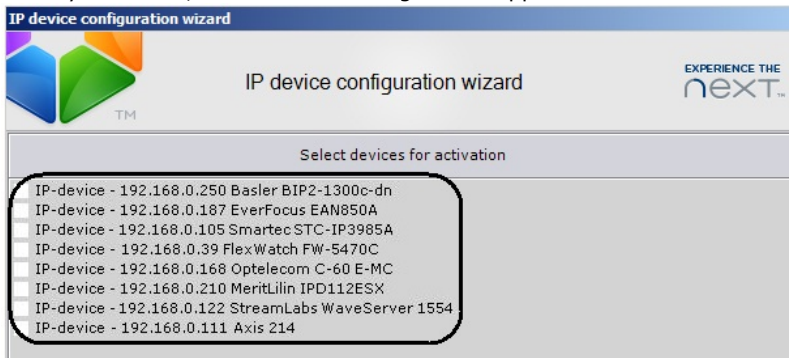

When you launch this application, the program will automatically search for connected IP devices. Devices which are found are displayed in the **Select devices for activation** list.

**Note**

IP devices whose vendor, model and/or firmware version has not been determined are displayed in the **Advanced configuration required**

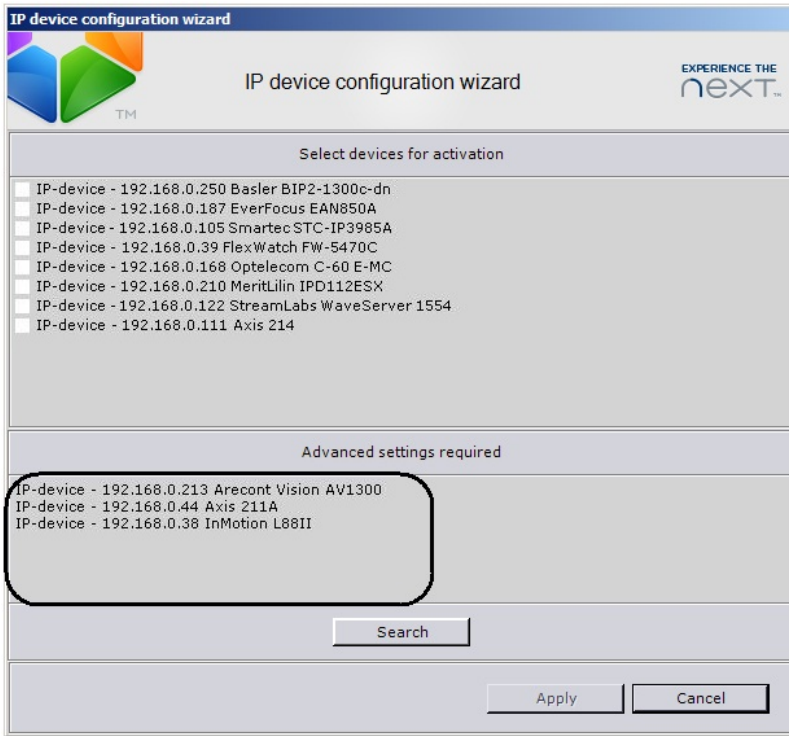

In the **Select devices for activation** list, select the check boxes for those devices which need to be registered as Axxon Next objects and then click **Apply**.

If you need to search for IP devices again, click **Search**.

After closing the IP device configuration application (by clicking **Apply** or **Cancel**), the user will be prompted to configure the default archive for the video cameras (IP devices) selected in the first step.

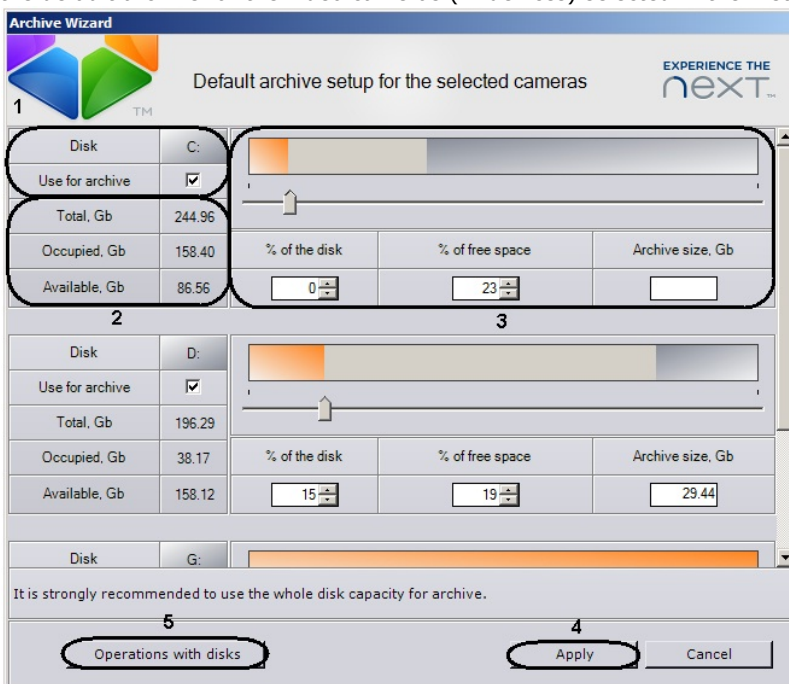

To skip configuration of the default archive for the selected video cameras and start the Axxon Next software package, click the **Cancel** button.

To configure the archive, you must perform the following steps:

1. Select the **Use for archive** check boxes for the disks which are to be used to store the default archive (1).

**Attention!**  
Only local disks can be used for archives. Archives cannot be hosted on a network disk (NAS)).

**Note**  
The following information is provided for each disk: total volume, total occupied space, and total free

space (2)

- If you need to use an archive volume already located on the disk, select the Use current volume check box (3).



**Note**

The size of the existing volume is indicated in the **Use current volume** field

- Specify the archive size (minimum of 1 GB) for each selected disk (3). You can specify the archive size by using one of the following four methods:
  - Move the slider to the position corresponding to the volume of disk space allotted for the archive.
  - Manually enter the archive size as a percentage of total disk space (in the **% of the disk** field).
  - Manually enter the archive size as a percentage of free disk space (in the **% of free space** field).
  - Manually enter the archive size in gigabytes (in the **Archive size, GB** field).



**Note**

The archive size assignment field and slider are dynamically linked; the values in the fields change as the slider moves, and vice versa



**Note**

The diagram over the slider serves as a graphic representation of the disk space used: gray represents used space, and orange represents the space allotted for the archive being created



**Note**

To allot an entire volume for an archive, you must first manually delete the file system on the disk. To do this, follow the steps below:

- Launch the Windows Disk Management (5).
- Delete the required volume.
- Create a new volume in the resulting unformatted area.
- Assign a letter to the volume, but do not format it.

Note that you cannot delete a partition on a removable disk in Disk Manager.



**Attention!**

The system disk cannot be completely allocated for an archive

- Click **Apply** (4).



**Note**

If an archive is configured to a disk containing an old volume that is unused, a dialog box warns you that the partition containing the archive volume will be formatted

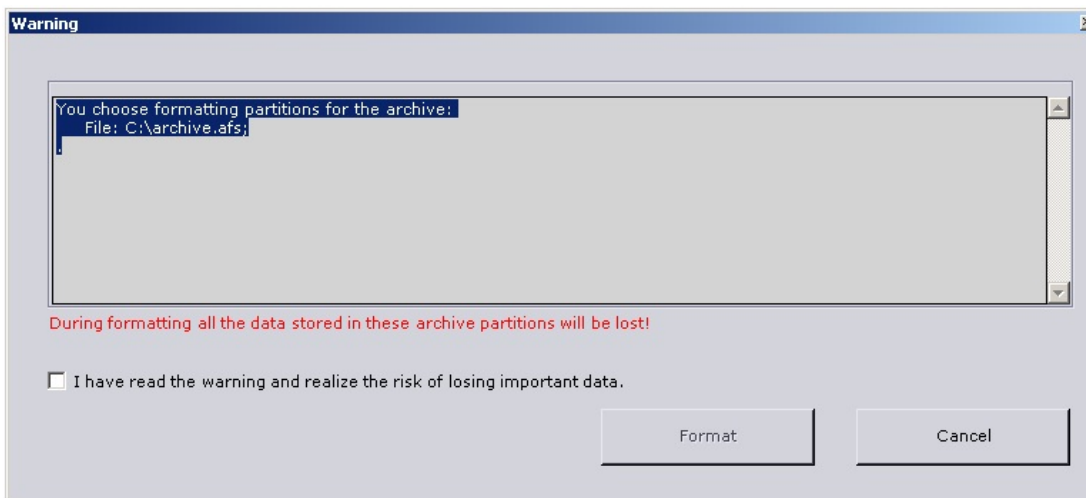

Read through the list of partitions that will be formatted. If the list is correct, select **I have read the warning and realize the risk of losing important data**, then click **Format**. Otherwise, click **Cancel** to return to preliminary archive settings.

Configuration of the default archive is complete.

## Configuring System Objects for Devices

## The Server Object

The **General Settings** group displays information about the software package (license, driver version, etc.) which cannot be edited.

The web server in the *Axxon Next* software package can be configured in the **Web Server** group of settings (see the section [Configuring the web server](#)).

[Play corresponding video](#)

## The Video Camera Object

Creation and configuration of the **Video camera** object is done in the **Hardware** tab. The object tree of a video camera is generated automatically according to its functions which are integrated into the Axxon Next software package (the presence of alarm inputs, relay outputs, PTZ unit, etc.).

The objects for the video cameras found on the network are first shown in the **Unallocated Equipment** list. After these objects have been moved to the list of server equipment, their configurations will be accessible for editing.

In the **Object Features** group you can see the following video camera features:

1. MAC address
2. IP address (determined automatically, can be changed if necessary)
3. Manufacturer, model, firmware
4. Driver information
5. Port used to transmit data between the video camera and the Axxon Next software package (this value is set to 80 by default but can be changed if necessary)

2. Object features	
Address	0.0.0.0
Driver version	3.0.0
Firmware	XPDN.A1-1.1.10.126
MAC-address	
Model	ISMC1063N
Port	80
Produced by	CNB
Video channel №	0

To configure the **Video camera** object, perform the following:

1. Highlight the object in the list of devices on the Server (**1**).

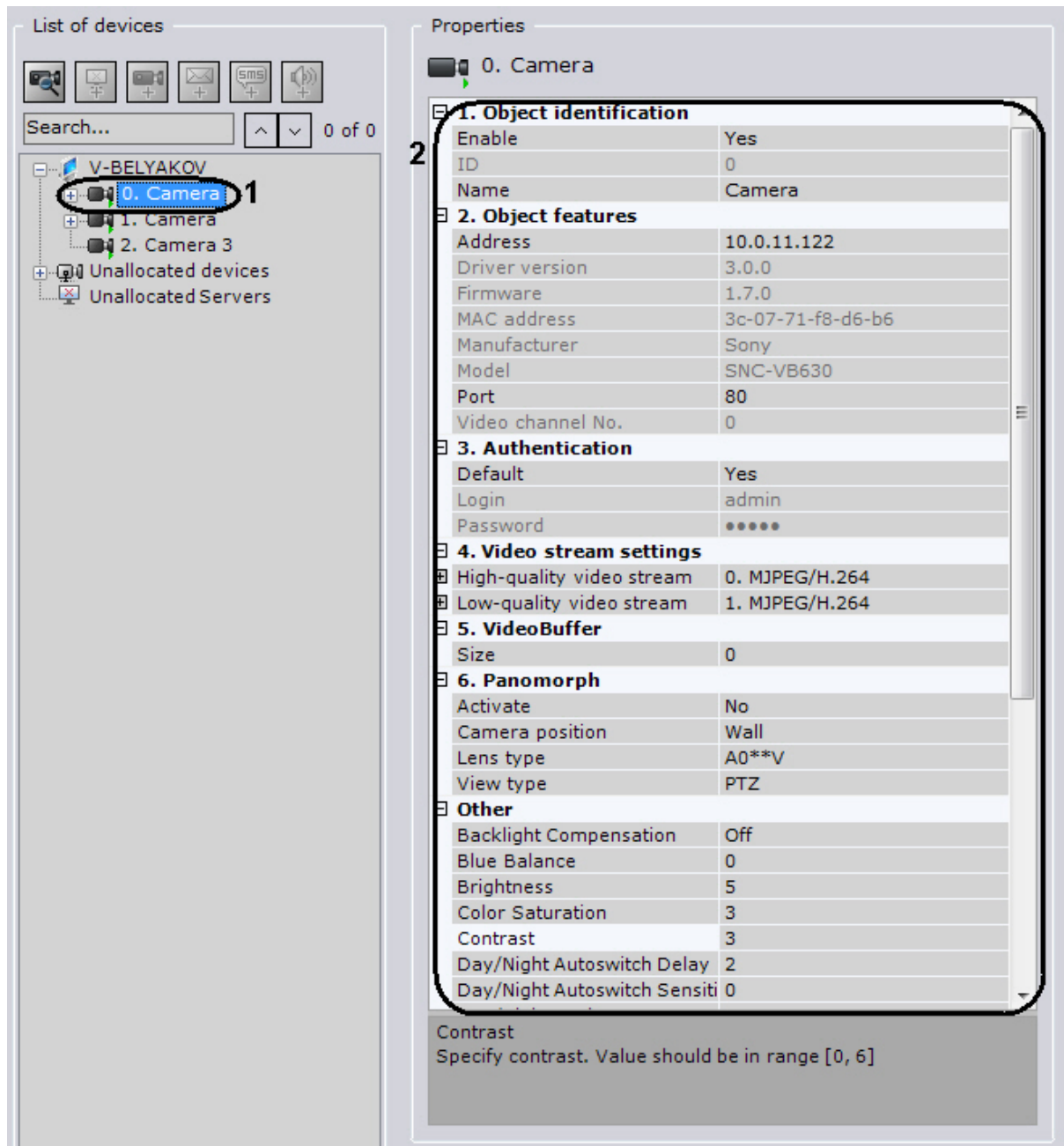

The configuration field for the selected object will be displayed in the area on the right (2).

2. Select **Yes** from the list in the **Enable** field to enable the video camera.

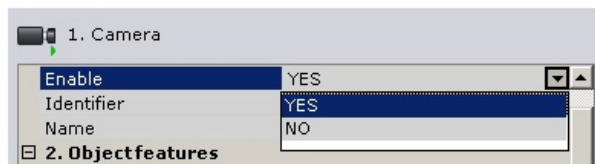

3. Assign the video camera a name which will be displayed in the objects tree and in the viewing tile, in the **Name** field.

The ID of a video camera object is set automatically during creation. However, it can be edited in the corresponding field. The ID is also the serial number of the video camera: in the **Monitor** interface window and in the equipment tree of the server, the video cameras are placed in ascending order by ID.

Enable	YES
Identifier	1
Name	

4. Enter the number of the network port through which data exchange between the video camera and the software will take place, if needed. The default value is **80**.

**Note**

At first the port number is set through the camera's Web interface

Model	SNC-C7478
Port	80
Produced by	Samsung

- If the user name and/or password for connecting to the video camera are different from the factory settings, select **No** in the **Use by default** field within the **Authentication** parameter group and define the connection parameters.



**Note**

The user name and password can be changed in the video camera's web interface

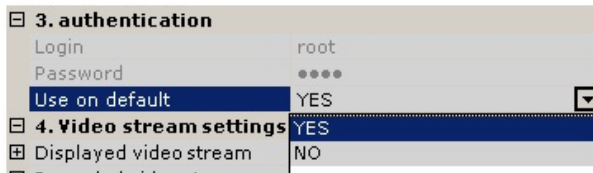

When this method of authentication is selected, the software package will connect to the video camera with the indicated user name and password.

- If a video camera supports multistreaming, you can configure two video streams separately: **high quality** and **low quality**. If the camera does not support multistreaming, configuration will be available for only one video stream..

<b>4. Video stream settings</b>	
High-quality video stream	0. H.264
Bit Rate	2048
Compression Mode	Variable Bitrate
Frames per second (fps)	12
Keyframes Interval	25
Quality	Medium level
Resolution	704 x 576
Transport Protocol	TCP
Video Codec	H.264
Low-quality video stream	1. H.264/MJPEG
Bit Rate	2048
Compression Mode	Variable Bitrate
Frames per second (fps)	12
Keyframes Interval	25
Quality	Medium level
Resolution	352 x 288
Transport Protocol	TCP
Video Codec	H.264



**Important**

The high-quality video stream is used to write video to the video archive. Either video stream can be selected for display in a viewing tile (see [Selecting video stream quality in a viewing tile](#)).

If a video camera does not support multistreaming, the parameters of the video streams are identical. In this case only the parameters of the high-quality video stream are editable (the parameters of the low-quality video stream are adjusted automatically).

4. Video stream settings	
High-quality video stream	0. MPEG4/MJPEG
Bit rate	500
Compression mode	Variable bitrate
Compression priority	None
Compression rate	10
Frames per second (fps)	25
Resolution	640 x 480 (VGA)
Transport protocol	UDP
Video Codec	MPEG4
Low-quality video stream	0. MPEG4/MJPEG
Bit rate	500
Compression mode	Variable bitrate
Compression priority	None
Compression rate	10
Frames per second (fps)	25
Resolution	640 x 480 (VGA)
Transport protocol	UDP
Video Codec	MPEG4



**Note**

In most cases, the following parameters are set for video streams: bit rate, compression rate, frame rate, and resolution. Detailed information on configurable parameters can be found in the official reference documentation for the video camera



**Note**

When some video stream parameters are changed, the video camera may automatically restart, in which case it will become unavailable for some time (depending on the video camera)

- Data coming from cameras can be accumulated on the Clients into a buffer of a determined length, and then sent out from the buffer for processing. To do so, in the **Video buffering** settings group, in the **Buffer size** field, set a buffer size (in milliseconds).

5. VideoBuffer	
Size	0

This value should be between 50 and 1000

milliseconds. If the value **0** is selected, video buffering is disabled.

- To configure a fisheye camera, go to the **Panomorph** settings group for the camera (see [Configuring fisheye cameras](#)).

5. Panomorph	
Activate	Yes
Camera position	Ceiling
Lens type	A0**V

- Configure additional video camera parameters (such as contrast, brightness, and color saturation) in the **Other** group, based on their description in the Axxon Next interface or in more detail in the official reference documentation for the video camera.

Other	
Brightness	50
Color saturation	50
Contrast	50
Hue	50
Image mirror	No
Video image flip	No

**Color saturation**  
Specify Saturation (color depth). Value should be in range [0, 100]

- Click **Apply** in the bottom-right corner of the program window to apply the new settings.

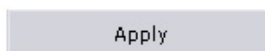

After saving the settings, the video camera will be activated and shifted to the work mode that corresponds to the set parameters. The **Video camera** icon indicator will turn green and the image from the camera will be displayed in the preview window.



## Configuring fisheye cameras

If you are using a fisheye camera or video camera with a panomorph lens, configure the following settings of the **Video camera** object, in the **Panomorph** settings group:

1. To activate panoramic view, in the **Activate** list (1), select **Yes**.

5. Panomorph		
Activate	Yes	1
Camera position	Ceiling	2
Lens type	A0**V	3
Display mode	Perimeter	4

2. In the **Video camera position** list (2), select the mount of the video camera.
3. If it is a fisheye camera, select the **Standard fisheye lens** lens type (3). If it is a video camera with a panomorph lens, select the corresponding type (3).



### Important!

Some system features and functions depend on the chosen position of the video camera: digital zoom, display of video in the surveillance sector on the map, and immersive mode

4. If it is a video camera with an Immersion lens, select the appropriate display mode (4): 360 panorama with virtual telemetry (**PTZ**) or 180 panorama (**Perimeter**).
5. Click the **Apply** button.

Configuration of the fisheye camera is complete.

## Configuring virtual video cameras

The *Axxon Next* software package enables you to work with virtual video cameras.

This requires running *Axxon Next* in test mode and consists of imitating a stream of video data by playing an available video clip (recording). You can play video recordings using video compression algorithms supported by Axxon Next (MJPEG, MPEG-2, MPEG-4, MxPEG, H.264, and Motion Wavelet).

To create and configure a virtual video camera, complete the following steps:

1. Add a **Video camera** object.

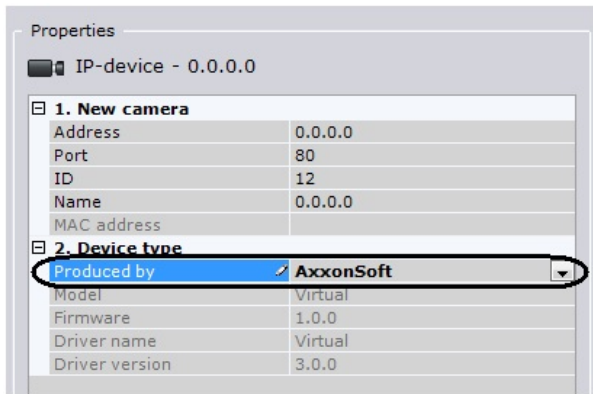

2. Select **AxxonSoft** from the **Produced by** list and click **Apply**.
3. In the **Folder** field, specify the storage location of the video clip that will be used to imitate a video signal.

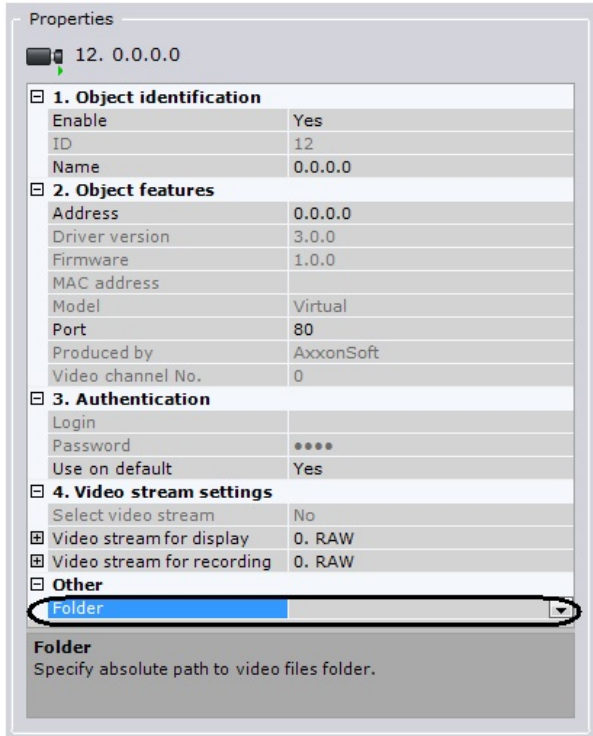

**Note**  
The name of the video file and its file path must consist only of Latin characters

4. Click the **Apply** button.

The video file in the selected folder will then be played back in a repeating cycle. If the folder contains several files, they will all be played in a random order.

## Configuring connection of video cameras via RTSP

**Important!**  
AxxonSoft does not guarantee the proper operation of video cameras connected via the RTSP protocol and does not offer technical support to users in such situations

Axxon Next can relay audio and video over RTSP.

To connect video cameras via RTSP:

1. To add a **Video camera** object, click the  button.
2. In the list of manufacturers, select **RTSP (2)**.

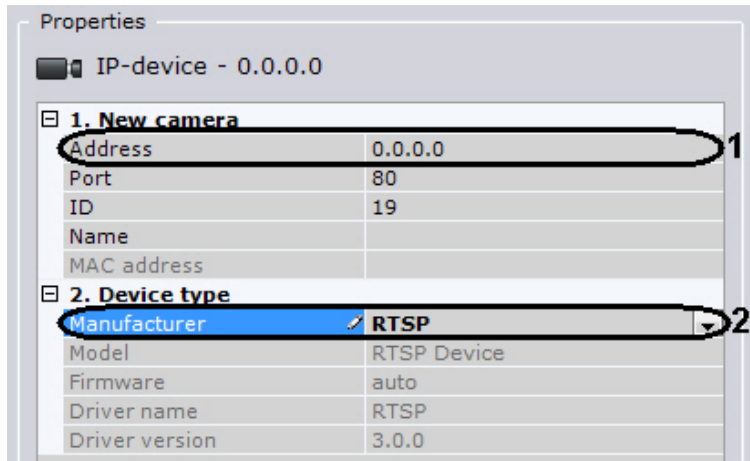

- In the **Address** field, enter the address of the RTSP broadcast (1). In general form, the address is as follows: **rtsp://<IP address of RTSP server>:<Port on RTSP server>/<Path>**.



**Important!**

Generally, RTSP server parameters (port and path) are set through the web interface of the video camera. To do so, refer to the manufacturer's documentation for the video camera



**Note**

In some cases, the address format may be different. For example, a user name and password may be added to the address for connecting to the video camera.

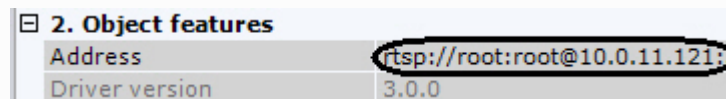

You are advised to refer to the manufacturer's documentation for the video camera.

- Click the **Apply** button.

The **Video camera** object is created. If the address of the RTSP server is correctly specified, the video feed from the camera is shown in a preview tile.

If video is unavailable, examine the log file *APP\_HOST.lpint*, which is located in the folder <Axxon Next installation folder>\AxxonNext\Logs.



**Important!**

If APP\_HOST.lpint is *empty*, in the log management utility, check the *detail level of logging for the Axxon Next Server*. The recommended detail level is **Debug**.

## The IP Server Object

Every channel between an analog video camera and an IP server corresponds to a child **Camera** of the **IP server** object. Configuration of these objects represents the configuration of the IP server's channels.

To configure the IP server parent object, perform the following:

- Select the IP server object in the objects tree (1).

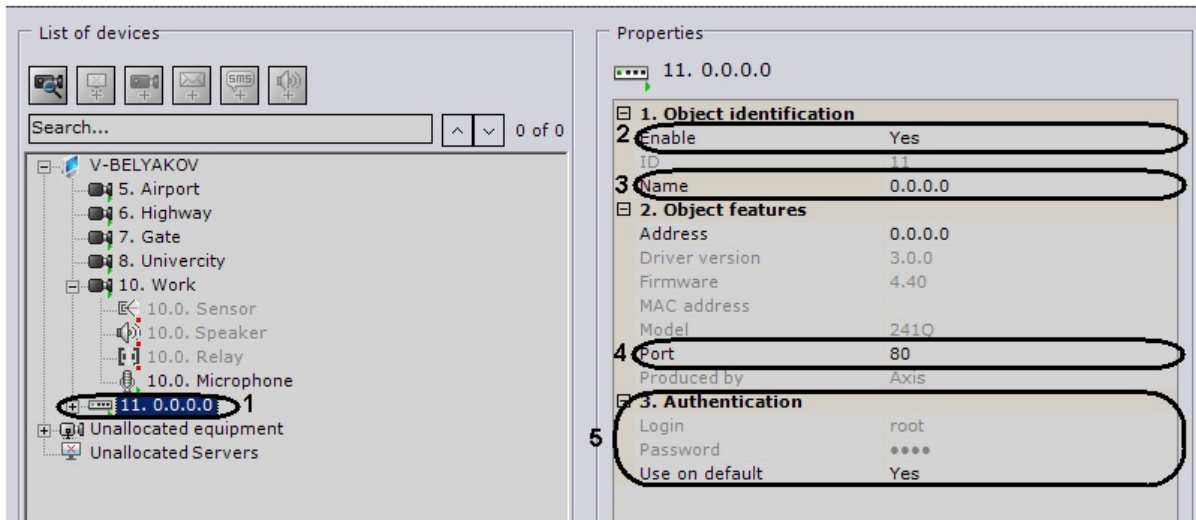

2. Select **Yes** from the list in the **Enable** field to enable the object (2).
3. Enter the name of the IP server in the Name field (3).
4. Specify the number of the network port (4). The default value is **80**.



**Note**

The port number is initially set through the IP server's web interface

5. Set the authentication mode (5)



**Note**

The login and password for connecting to the IP server are set through its Web interface

6. Click the **Apply** button.

The IP server and its video cameras will then be enabled, and the icon indicators for the IP server and video cameras in the objects tree will turn green.

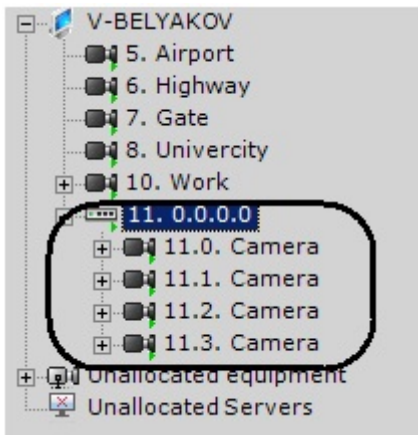

Configuration of IP server channels must be performed separately for each channel (with the help of child objects of **Video camera**).

## The Microphone Object

If a microphone is part of an IP server, then you must specify the video camera to which it will be linked in the settings of the given microphone. When you do this, the **Microphone** object will become a child of the specified **Camera** object.



**Attention**

When a microphone is reassigned from one camera to another, all previously recorded audio is also transferred; when recorded video on the new camera is played, the transferred audio is played back



**Note**

This setting is used during synchronized video and audio monitoring of a situation as well as during synchronized video and video recording to the archive (see the section [Audio Monitoring](#))

In all other cases the **Microphone** object will automatically be displayed in the objects tree as a child of the video camera itself.

To configure the **Microphone** object, perform the following:

1. Select the **Microphone** object in the objects tree.

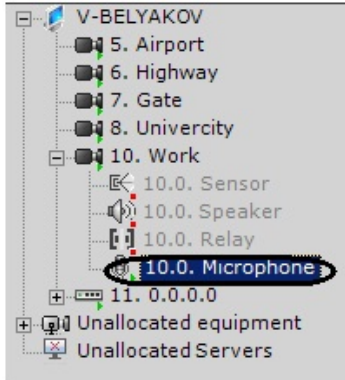

2. Enable the microphone by selecting **Yes** in the **Enable** field (1).

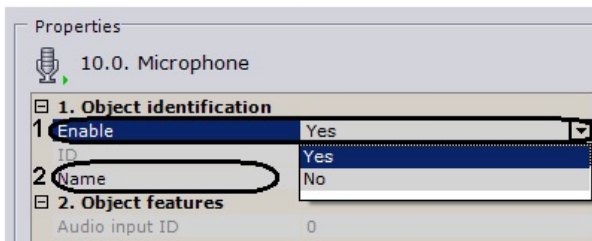

3. Enter the name of the microphone in the **Name** field (2).
4. Configure additional microphone parameters (audio codec, bit rate, etc.) in the **Other** group using their descriptions in the interface of the Axxon Next software package or, for more detail, in the official reference documentation of the parent video camera.

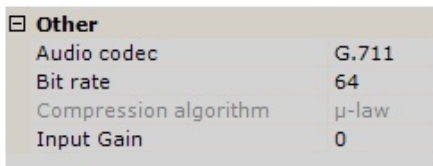

5. Click the **Apply** button.

The microphone will then be switched to its assigned work mode.

To check the microphone's operation, you must perform the following steps:

1. Select the **Sound on/off** check box in the **Summary** group.

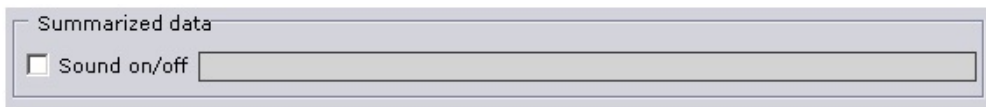

2. Provide an audio signal to the microphone.
3. If the microphone is configured correctly, the audio signal will be transmitted to the server's speakers. The strength of the incoming audio signal will be displayed on the indicator to the right of the **Sound on/off** check box.

Checking microphone operation is now complete.

[Play corresponding video](#)

## The Telemetry Object

The **Telemetry** object is displayed in the device list as the child object of its respective PTZ camera. To configure a camera's PTZ controls, the following must be true:

1. Select the Telemetry object in the objects tree



2. Enable the PTZ device by selecting **Yes** in the **Enable** field (1).

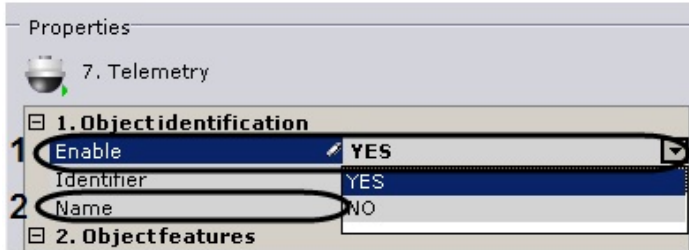

3. Enter the name of the PTZ device (2).
4. Enable patrol mode. When patrolling is enabled, the video camera automatically changes its position along a route defined in its presets list

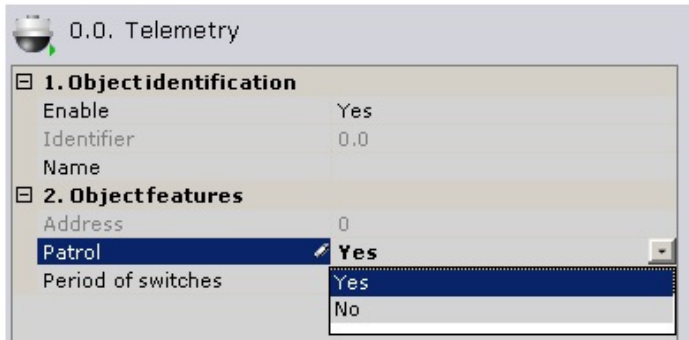

**Note**  
Patrolling is enabled through the **Patrolling** button in the PTZ camera control panel (see the section titled Patrolling).

5. Set the interval of time (in seconds) at which the PTZ device will switch between presets while in Patrol mode.



6. Click the **Apply** button.

The PTZ device will then be switched to its assigned work mode. To check the functioning of the PTZ device, click the **Test** button. If the PTZ device is configured correctly, it will turn one step and return to its original position.

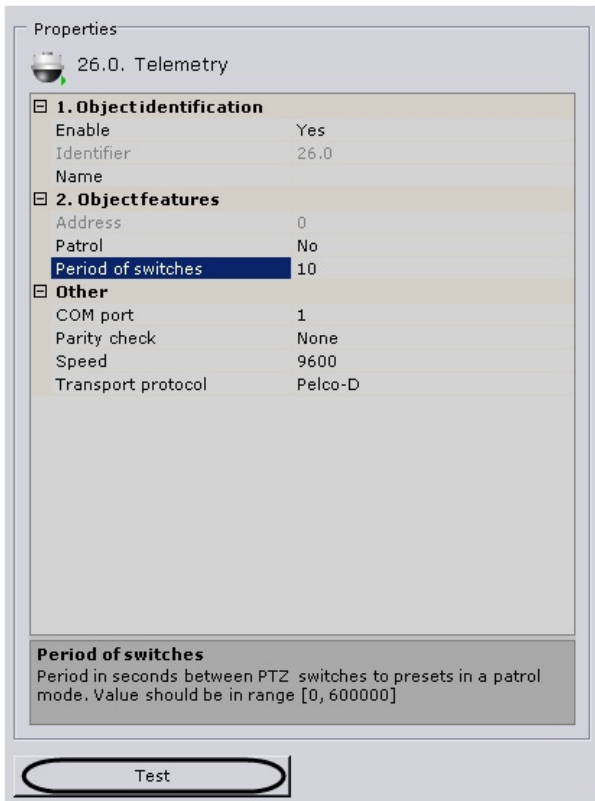

[Play corresponding video](#)

## The Sensor Object

If a video camera has a built-in or connected discrete input, a **Sensor** object is displayed as the child object of the video camera. The number of **Sensor** objects for a video camera is equal to the number of discrete inputs for the camera.

To configure a **Sensor** object, perform the following:

1. Select the **Sensor** object in the objects tree (1).

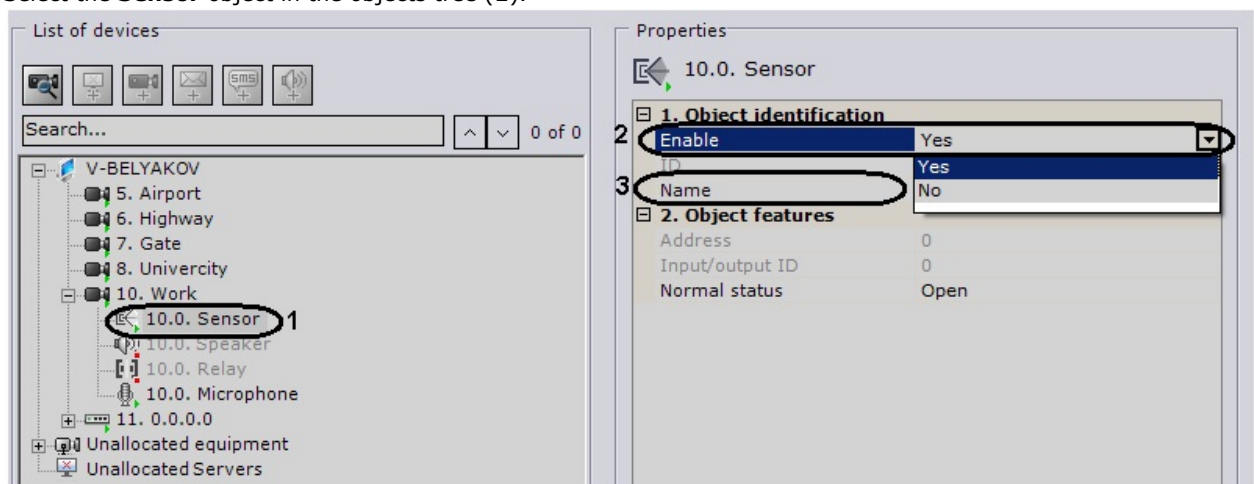

2. Enable the device (2).
3. Enter the name of the sensor (3).
4. Set the status to which the sensor will be set when no alarm is present.

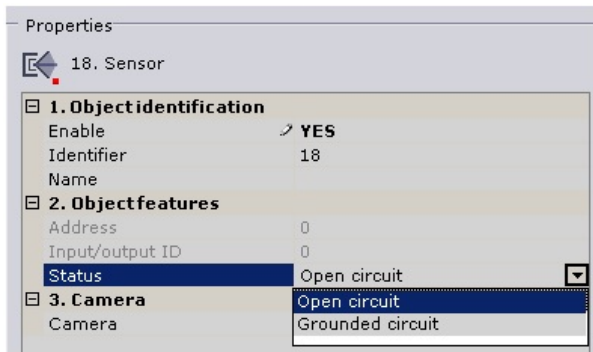

5. Click the **Apply** button.

The sensor will then be switched to its assigned work mode.

The current status of the sensor is displayed in the **Sensor information** group.

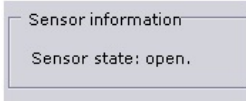

If a sensor is part of an IP server, the sensor settings allow choosing the video camera of the IP server it will be matched to. When you do this, the sensor object will appear as the child object of the specified camera in the object tree.

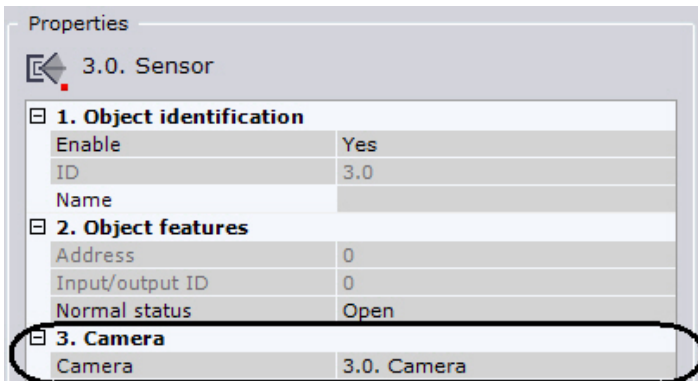

[Play corresponding video](#)

## The Relay Object

If a video camera has a built-in or connected discrete output, a **Relay** object is automatically displayed as the child object of the video camera. The number of **Relay** objects for a video camera is equal to the number of discrete outputs for the camera.

To configure a **Relay** object, perform the following:

1. Select a **Relay** object in the objects tree.
2. Enable the device (1).

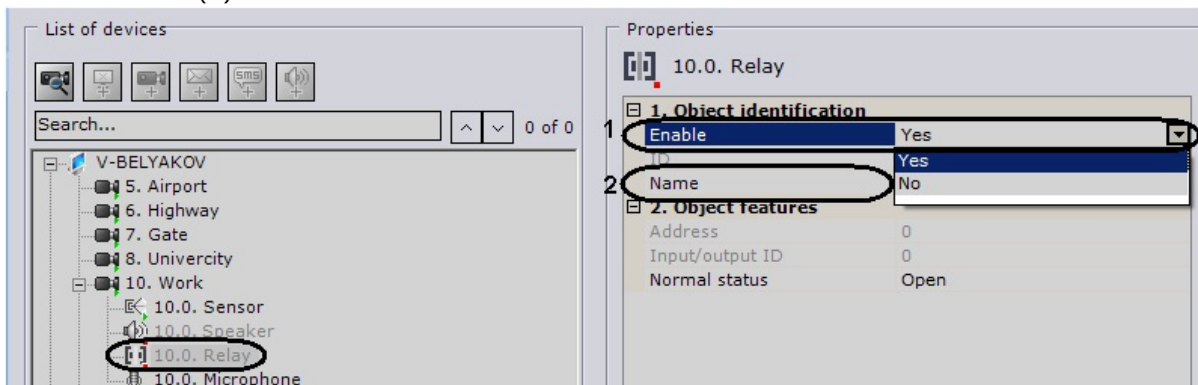

3. Enter the name of the relay (2).
4. Set the status to which the relay will be set when no alarm is present.

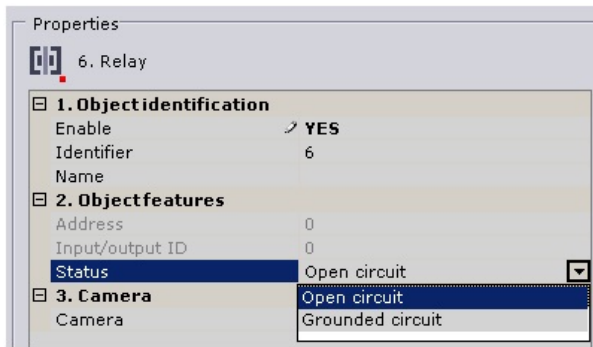

5. Click the **Apply** button.

The relay will then be switched to its assigned work mode.

To check the functioning of the relay, click the **Test** button. If the relay is configured correctly, its status will briefly change.

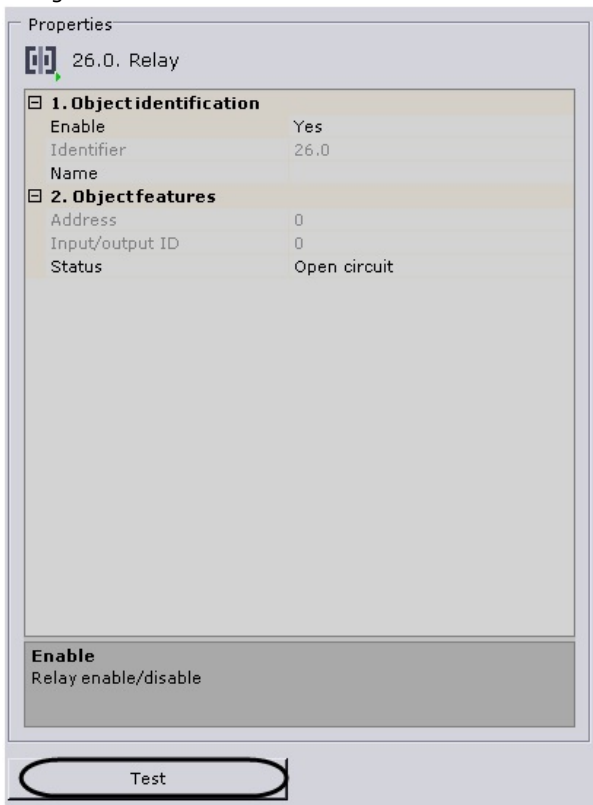

If a relay is part of an IP server, the sensor settings allow choosing the video camera of the IP server it will be matched to. When you do this, the relay object will appear as the child object of the specified camera in the object tree.

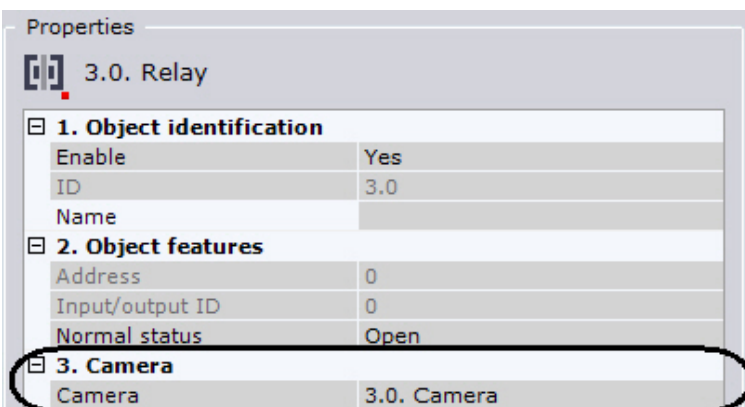

[Play corresponding video](#)

## The Speaker Object

The **Speaker** object is used to configure audio notification, which is launched as an automatic response when a detection tool is triggered.



**Attention!**

Audio notifications cannot be played back via the system speakers on a remote Client. In this case, you are advised to create an automatic rule to [run an external program on Clients](#).

In Axxon Next you can create the following types of **Speaker** objects:

1. **IP speaker device.** Created automatically if there is an audio outlet on an IP device.



**Note**

One audio outlet on an IP device corresponds to one child **Speaker** of the **Camera** object

2. **System speaker.** Created manually. Sound on the system speaker is played back using the server's sound card.

A **Speaker** object can play audio notification files with the extensions:

1. .wav
2. .mp3
3. .mkv
4. .avi

The following audio notification file encoding formats are supported:

1. G.711
2. G.726
3. PCM

The audio notification file should be stored on the computer corresponding to the **Server** object on the basis of which the **Speaker** object is registered.

[Play corresponding video](#)

## Creating an Object

To create a **Speaker** system object, you must perform the following steps:

1. In the list of devices, highlight a **Server** object (1).

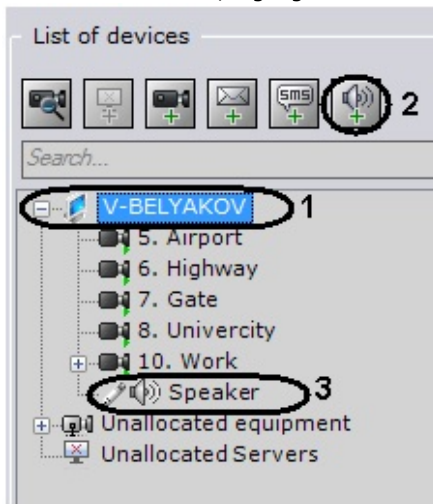

2. Click the  button (2).
3. Click the **Apply** button.
4. When you do this, the **Speaker** object appears in the list of devices (3).

Creation of the **Speaker** object is complete.

## Configuring a Speaker Object

To configure a **Speaker** object, you must perform the following steps:

1. In the list of devices, highlight the **Speaker** object which needs to be configured.

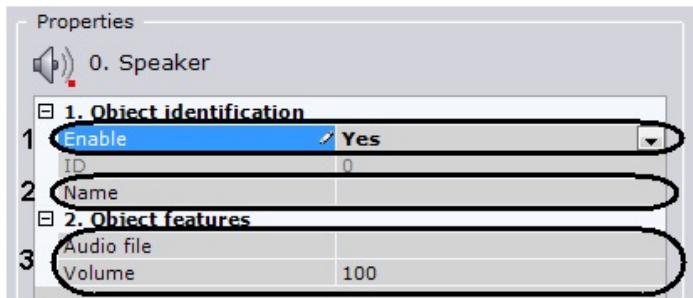

2. Select **Yes** from the list in the **Enable** field to activate the **Speaker** object (1).
3. In the **Name** field (2), enter the desired name of the **Speaker** object.
4. In the **Audio file** field (3), enter the full path to the audio notification file.
5. In the **Volume** field (4), enter the desired speaker volume level.



**Note**

When configuring the speaker of an IP device, you can set other parameters as well, such as the compression algorithm for the audio signal sent to the speaker for playback. Which speaker parameters you can configure is determined by the protocol for integration of the IP device and the Axxon Next software package

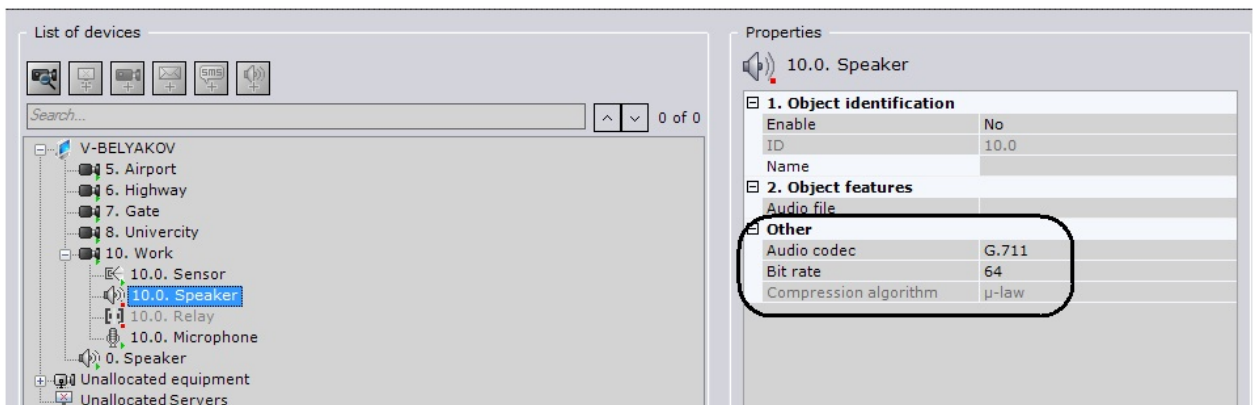

6. Click the **Apply** button.

Configuration of the **Speaker** object is now complete.

## Checking Audio Notification

To check audio notification from a **Speaker** object, click the **Test** button (1).

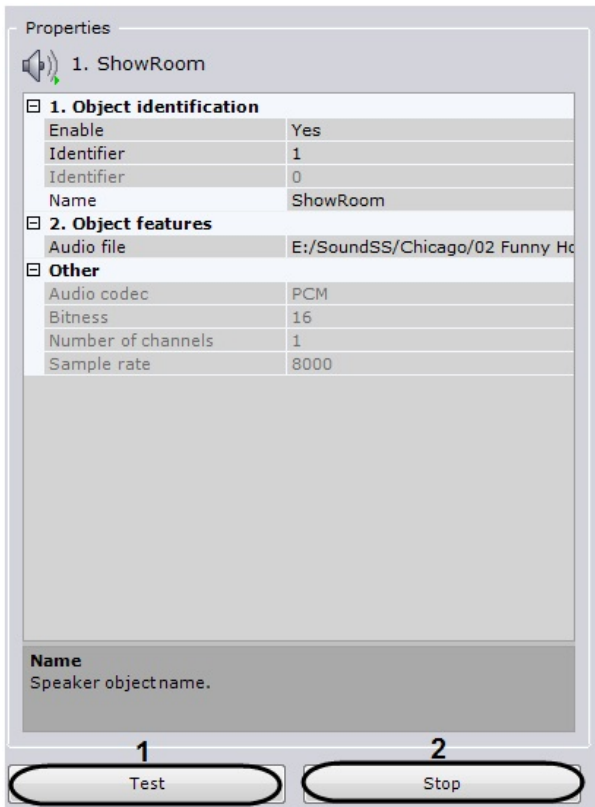

When you do this, the audio notification file whose path you indicated in the corresponding field plays back (see the section [Configuring a Speaker Object](#)). To stop the test playback, click the **Stop** button (2).

## The E-mail Object

The **E-mail** object is used to configure electronic messages which can then be sent to a user as an automatic response when a detection tool is triggered.

[Play corresponding video](#)

## Creating the E-mail Object

To create an **E-mail** object, you must perform the following steps:

1. In the list of devices, highlight a **Server** object (1).

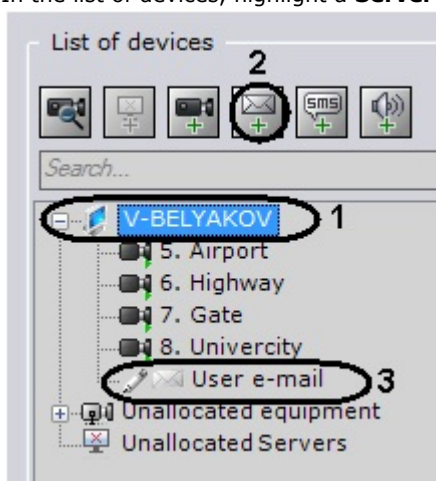

2. Click the  button (2).
3. Click the **Apply** button.
4. When you do this, an **E-mail** object appears in the list of devices (3).

Creation of the **E-mail** object is now complete.

## Configuring the E-mail Object

To configure an **E-mail** object, you must perform the following steps:

1. In the list of devices, highlight the **E-mail** object which needs to be configured (1).

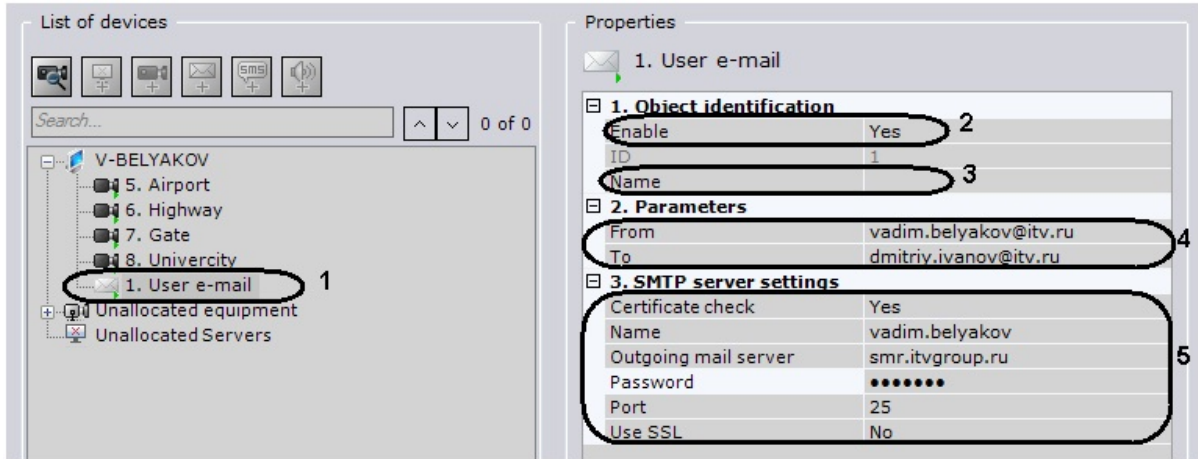

2. Activate the **E-mail** object (2) by selecting **Yes** in the **Enable** list.
3. In the **Name** field (3) enter the desired name of the **E-mail** object.
4. In the **Notification delivery parameters** field (4), set the delivery parameters for the e-mail message:
  - a. In the **To** field, enter the e-mail address to which the messages will be sent.
  - b. In the **From** field, enter the e-mail address from which the messages will be sent.
5. In the **SMTP server settings** field (5), enter the settings of the outgoing mail server:
  - a. In the **Name** field, enter the name of the user account used to send messages on the outgoing mail server.
  - b. If you need to use an SSL-encrypted connection when connecting to the outgoing mail server, select **Yes** from the **Use SSL** list.
  - c. In the **Password** field, enter the password for the user account on the outgoing mail server.
  - d. In the **Port** field, enter the number of the port used by the outgoing mail server.
  - e. If, when using an encrypted connection, the SSL certificate must be checked, select **Yes** from the **Certificate check** list.
  - f. In the **Outgoing mail server** field, enter the name of the outgoing SMTP mail server.
6. Click the **Apply** button.

Configuration of the **E-mail** object is now complete.

## Checking E-mail Notification

To check e-mail notification from an **E-mail** object, send a test message by clicking the **Test message** button.

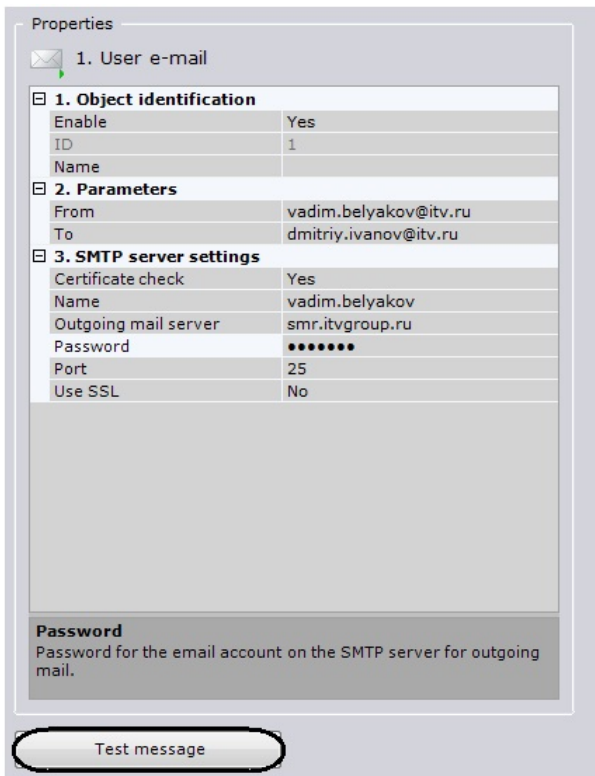

When you do this, the following message is sent to the e-mail address indicated in the **To** field (see the section [Configuring the E-mail Object](#)): "This is a test message to check Axxon Next E-mail notification."

**Note**

If the recipient does not receive the message, make sure that the settings of the **E-mail** object have been properly configured

## The SMS Object

The **SMS** object is used to configure SMS messages which can then be sent to users as an automatic response when a detection tool is triggered.

**Note**

If a USB modem is used to send SMS messages, use the modem utility from the modem software bundle. It will unlock the modem for correct operation

## Procedure of configuring SMS notifications

To configure SMS notifications:

1. Stop the Server.
2. Connect a modem and, in the utility supplied with the modem, wait for the signal level to be determined.
3. Make sure that the number of the SMS center is shown. Do not connect to the Internet.
4. Start the Server and Client. Create and configure an **SMS** object.

## Creating the SMS Object

To create an **SMS** object, you must perform the following steps:

1. In the list of devices, highlight a **Server** object (1)

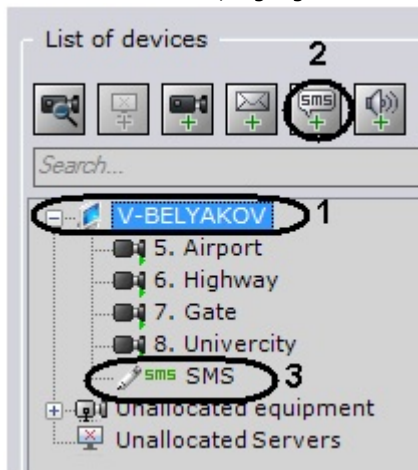

2. Click the  button (2).
3. Click the **Apply** button.
4. When you do this, the **SMS** object appears in the list of devices (3).

Creation of the **SMS** object is now complete.

## Configuring the SMS Object

To configure an **SMS** object, you must perform the following steps:

1. In the list of devices, highlight the **SMS** object which needs to be configured (1).

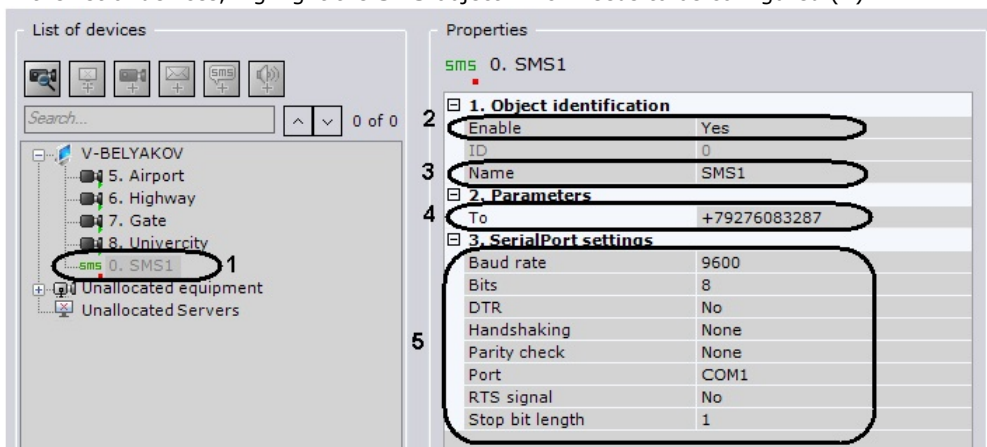

2. Activate the **SMS** object (2) by selecting **Yes** in the **Enable** list.

3. In the **Name** field (3) enter the desired name of the **SMS** object.
4. In the **To** field (4), enter the cellular telephone number, in international format (+<country code>x), to which messages will be sent.
5. In the **SerialPort settings** group (5), indicate the port settings used to connect to the GSM modem by which SMS messages will be sent:
  - a. If you need to use a DTR control signal, select **Yes** from the **DTR** list.
  - b. In the **Bits** field, enter the number of bits in the byte of a data packet.
  - c. In the **Stop bits length** field, enter the number of bits in the stop bit of a data packet.
  - d. If you need to use a parity check when transmitting data, select the desired method of parity check from the Parity list.
  - e. From the **Port** list, select the serial port used to connect to the GSM modem.
  - f. If hardware control of the serial port data protocol is enabled (see step 5.8) and you need to use an RTS signal, select **Yes** from the **RTS signal** list.
  - g. Select the speed for data transmission via the GSM modem from the **Baud rate** list.
  - h. If you need to control the serial port data protocol, select the desired method of control from the **Handshaking** list: hardware (RTS/STS), software (XOn/XOff), or alternating.
6. Click the **Apply** button.

Configuration of the **SMS** object is now complete.

## Checking SMS notifications

To check SMS notifications from an SMS message object, send a test message by clicking the **Test message** button.

The screenshot shows the 'Properties' dialog box for an SMS object. The 'To' field is highlighted with a red box. Below the dialog is a 'Test message' button.

1. Object identification	
Enable	Yes
ID	0
Name	
2. Parameters	
To	+79345784251
3. Serial Port settings	
Baud rate	9600
Bits	8
DTR	No
Handshaking	None
Parity check	None
Port	COM3
RTS signal	No
Stop bit length	1

**To**  
Recipient's cell phone number for SMS notifications.

Test message

When you do this, the following message is sent to the mobile number indicated in the **To** field: "This is a test message to check Axxon Next SMS notification."



### Note

If the recipient does not receive the message, make sure that the settings of the SMS object have been properly configured

## Configuring the web server

The web server allows accessing Axxon Next remotely over the Internet (see [Working with Axxon Next Through the Mobile Clients](#), [Working with Axxon Next Through the Web Client](#)).



### Attention

The web server recodes the video that it receives, by using the MJPEG compression algorithm. This codec can

cause the bitrate (Mb/s) to become very large.

To configure the web server in the *Axxon Next* software package:

1. Select a **Server** object.

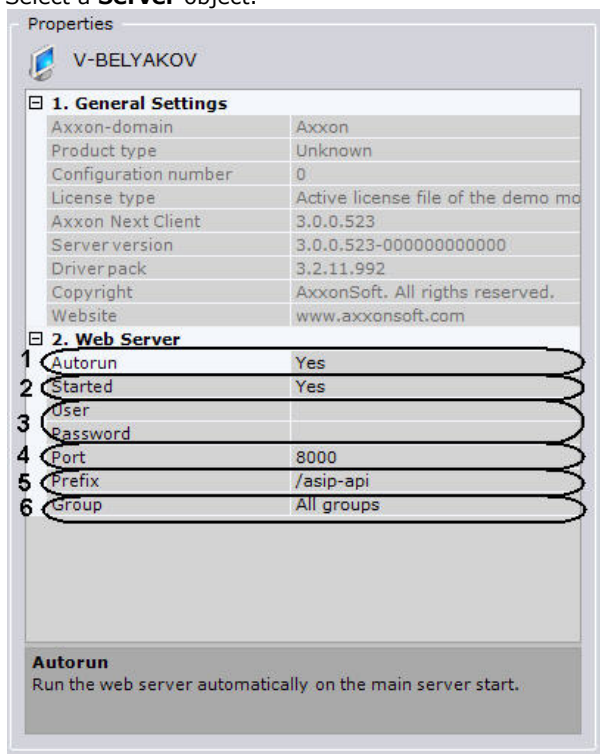

2. If you want for the web server to start at the same time as the Server in the *Axxon Next* software package, set the **Aautorun** setting to **Yes** (1). The default value is **Yes**.
3. If you want to disable the web server, set the value of **Started** to **No** (2).
4. In the corresponding fields, enter the user name and password for connecting to the web server (3).



#### Attention!

The user name for connecting to the web server must consist entirely of characters in the ASCII 128-character set: English letters, Arabic numerals, punctuation marks, and some control characters

5. In the **Port** field, enter the port number on which the web server will be located (4).
6. In the **Prefix** field, enter the prefix that is added to the server address (5).
7. In the **Group** list, select the group of video cameras that you want to make accessible on the web server (6).
8. Click the **Apply** button.

The web server is now configured and available over the Internet at the following address: <http://<IP address of Axxon Next Server>:<Port>/<Prefix>>. For example, if the server's IP address is **10.0.11.1**, the port is **8000**, and the prefix is **/asip-api**, then the web server can be accessed at the following address: <http://10.0.11.1:8000/asip-api>.

**Play corresponding video**

## Configuring video camera groups

You can manually group video cameras to enable quicker selection of a specific video camera for display.

Video camera groups are configured through the interface using the **Devices** tab (under **Settings**). To configure device groups, you must have the appropriate permissions to configure devices.

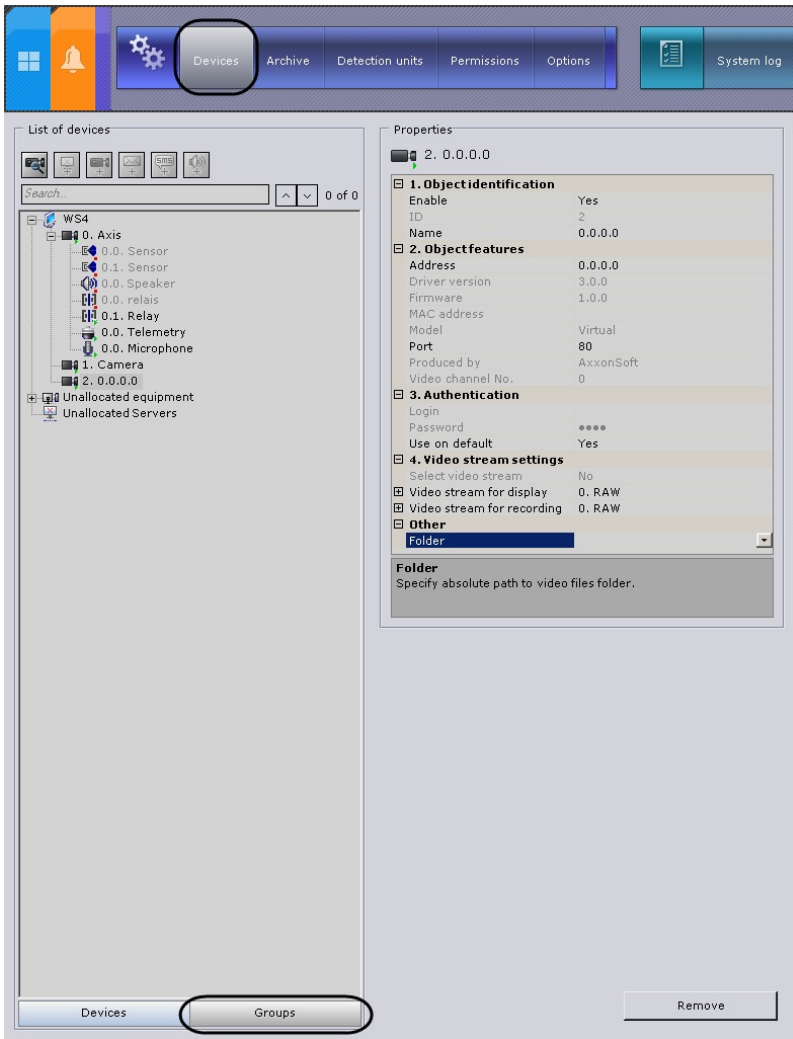

## Play corresponding video

### Procedure for configuring video camera groups

To configure video camera groups, complete the following steps:

1. Create **Group** objects.
2. Add video cameras created in the system to **Group** objects.
3. Create a system of groups and subgroups.

### Creating a Group object

To create a **Group** object, complete the following steps:

1. Go to the **Groups** tab.

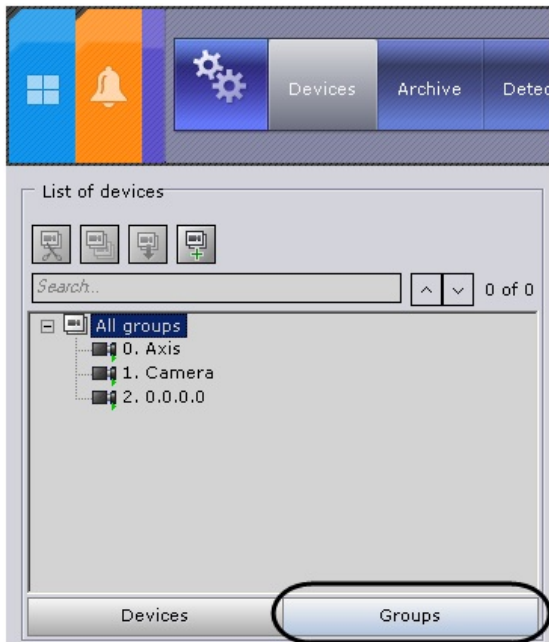

- To create a **Group** object, click the  button or select **Add group** in the context menu of the **All groups** object.



**Note**

The **All groups** object, which includes all video cameras created in the system, is accessible by default. It is impossible to delete this object. It is also impossible to delete video cameras from this group

- Specify the group name in the **Name** field.

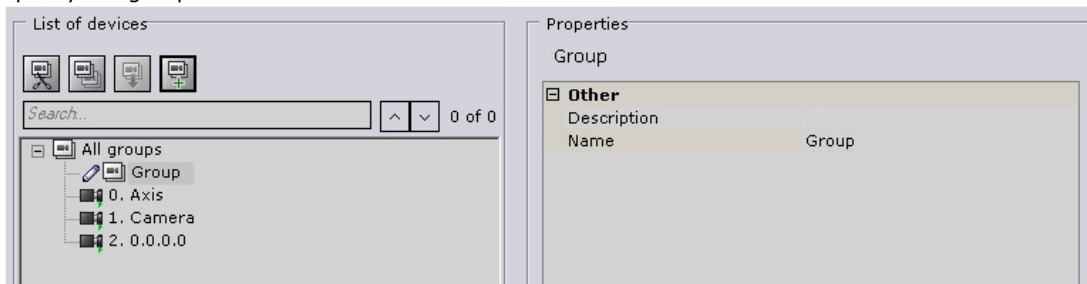

- Enter a description of the group in the appropriate field.
- Click the **Apply** button.

The **Group** object has now been created.

## Adding video cameras created in the system to Group objects

To add video cameras to groups, complete the following steps:





**Note**

Video cameras are added to groups via management operations (see the section titled [Managing Group and Video camera objects](#)). The standard method for adding video cameras to groups is presented below

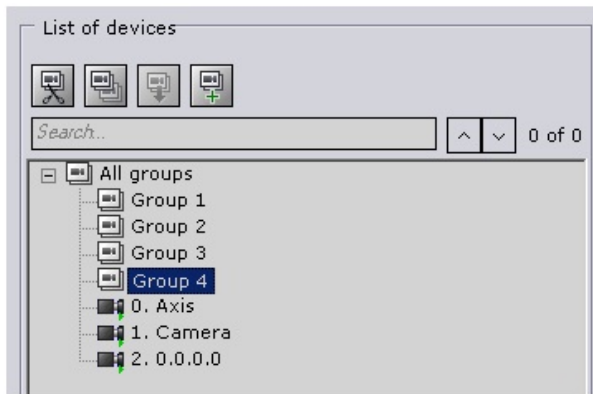
- In the **All groups** group, select a video camera to add to the selected group.



2. Click the  button or select **Copy** from the context menu of the selected video camera.
3. Select the **Group** object to which you need to add the video camera.
4. Click the  button or select **Paste** from the context menu of the selected group.
5. Fill the groups with the necessary video cameras (see steps 1-4).

**Note**  
One video camera can be assigned to multiple groups

6. Click the **Apply** button.

Adding video cameras to groups is now complete.

## Creating a system of groups and subgroups

Groups can be included within other groups, forming a system of groups and subgroups.

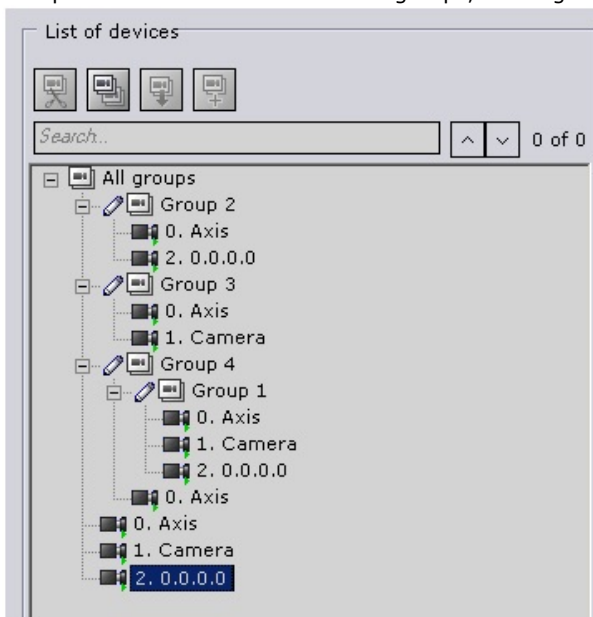

A system of groups and subgroups can be created via group management operations and video camera management operations (see the section titled [Managing Group and Video camera objects](#)).

**Group** objects can be moved or copied into other **Group** objects or into the **All groups** object.

## Managing Group and Video camera objects

The main operations used to manage groups and video cameras are presented in table.

Action	Execution
--------	-----------

## Cut/Paste



### Note

You can cut a **Video camera** object only from a **Group** object. You cannot cut a **Video camera** object from the **All groups** object. It is also impossible to cut the **All groups** object

## Using the context menu:

1. Bring up the context menu by right-clicking the **Video camera/Group** object.
2. Select **Cut**.
3. Bring up the context menu by right-clicking the **Group** object (or the **All groups** object if you want to move one of the groups) to which you want to move the **Video camera/Group** object.
4. Select **Paste**.

## Using your mouse:

1. Left-click and hold the **Video camera/Group** object.
2. Drag the object to the **Group** object (or to the **All groups** object if you are dragging a **Group** object).
3. Release the left mouse button.

## Using the toolbar:

1. Left-click the **Video camera/Group** object that you want to move.



2. On the toolbar, click .
3. Left-click the **Group** object (or the **All groups** object if you want to move one of the **Group** objects) to which you want to move the **Video camera/Group** object.



4. On the toolbar, click .

## Using the keyboard:

1. Left-click the **Video camera/Group** object that you want to move.
2. Press the key combination **Ctrl+X**.
3. Left-click the **Group** object (or the **All groups** object if you want to move one of the **Group** objects) to which you want to move the **Video camera/Group** object.
4. Press the key combination **Ctrl+V**.

## Copy/Paste

## Using the context menu:

1. Bring up the context menu by right-clicking the **Video camera/Group** object.
2. Select **Copy**.
3. Bring up the context menu by right-clicking the **Group** object (or the **All groups** object if you want to copy one of the groups) to which you want to move the **Video camera/Group** object.
4. Select **Paste**.

## Using your mouse:

1. Left-click and hold the **Video camera/Group** object while simultaneously holding down the **Ctrl** key.
2. Drag the selected object to the **Group** object (or to the **All groups** object if you are copying a **Group** object).
3. Release the left mouse button.

## Using the toolbar:

1. Left-click the **Video camera/Group** object that you want to copy.



2. On the toolbar, click .
3. Left-click the **Group** object (or the **All groups** object if you want to copy one of the **Group** objects) to which you want to copy the **Video camera/Group** object.



4. On the toolbar, click .

#### Using the keyboard:

1. Left-click the **Video camera/Group** object that you want to copy.
2. Press the key combination **Ctrl+**.
3. Left-click the **Group** object (or the **All groups** object if you want to copy one of the **Group** objects) to which you want to copy the **Video camera/Group** object..
4. Press the key combination **Ctrl+V**.

#### Deletion



#### Note

You can delete a **Video camera** object only from a **Group** object. You cannot delete a **Video camera** object from the **All groups** object

#### Using the context menu:

1. Open the context menu by right-clicking the **Video camera/Group** object that you want to delete.
2. Select **Delete**.

#### Using the keyboard:

1. Left-click the **Video camera/Group** object that you want to delete. .
2. Press the **Delete** key.

## Configuring detection tools

### Play corresponding video

### Types of detection tools

In the Axxon Next software package, several types of detection tools process incoming data:

1. Situation analysis detection tools
2. Basic detection tools:
  - a. Video analytics
  - b. Audio analytics
3. Detection tools embedded in a video camera (Embedded analytics):
  - a. Video stream processing detection tools
  - b. Detection tools which process signals from the video camera's sensor

Detection setup takes place using the interface in the **Detection Tools tab** (under **Settings**). For detection setup you must have the appropriate permissions.

The screenshot displays the 'Detection Tools' configuration interface. The top navigation bar includes 'Devices', 'Archive', 'Detection Tools' (highlighted), 'Permissions', 'Options', and 'System log'. A search bar is located above the tool list. The tool list is structured as follows:

- 5. Airport
  - Situation Analysis
    - Create...
  - Video Detection
    - Motion
    - Position Change
    - Quality Loss
- 6. Highway
  - Situation Analysis
    - Create...
  - Video Detection
    - Motion
    - Position Change
    - Quality Loss
- 7. Gate
  - Situation Analysis
    - Create...
  - Video Detection
    - Motion
    - Position Change
    - Quality Loss
- 8. University
  - Situation Analysis
    - Create...
  - Video Detection
    - Motion
    - Position Change
    - Quality Loss

The video preview window shows a busy airport terminal with many people. At the bottom right of the configuration window are 'Apply' and 'Cancel' buttons.

The structure of the Detection Tools list consists of three levels:

1. Video cameras
2. Types of video camera detection tools
3. Video camera detection tools



**Attention!**

For a video camera and its corresponding branch to appear in the Detection Tools list, the camera must be enabled in Axxon Next

Each type of detection corresponds to a parent object:

1. **Situation Analysis**
2. **Video detection tools**
3. **Audio detection tools**
4. **Embedded analytics**
5. **Sensors**

Parent objects for those detection tools which can be configured for a video camera are created automatically depending on the camera's specifications (see the device's official reference documentation). For example, an **Audio Analytics** object is created only when there is an audio outlet on the video camera, and an **Embedded analytics** object is created only when there are embedded analytics.

## Video suitability for detection tools (requirements)

For video analytics to work correctly, the following requirements must be met:

1. Camera requirements:
  - a. Resolution of at least 320x240 pixels
  - b. At least 6 frames per second
  - c. Color: video analytics work with both black-and-white and color images.
  - d. Camera shaking must not cause image shifting of more than 3% of the frame size.
2. Lighting requirements:
  - a. Moderate lighting. Lighting that is too little (night) or too much (bright sunlight) may impact the quality of video analytics.
  - b. No major fluctuations in lighting levels.
3. Scene and camera angle requirements:
  - a. Moving objects must be visually separable from each other in the video.
  - b. The background must be primarily static and not undergo sudden changes.
  - c. Minimal obscuration of moving objects by static objects (columns, trees, etc.).
  - d. Reflective surfaces and harsh shadows from moving objects can affect the quality of analytics.
  - e. Long single-color objects may not be tracked properly.
4. Object requirements:
  - a. Each of the linear measurements of objects in the frame must be at least 2% of the frame size.
  - b. It is recommended that the linear measurements of objects in the frame do not exceed 25% of the frame size.
  - c. The speed of objects in the frame must be at least 1 pixel per second.

## Situation Analysis Detection Tools

[Play corresponding video](#)

### Types of Situation Analysis Detection Tools

The following detection tools enable analysis of the situation in a video camera's field of view.

Name of a Detection Tool object	Detection description
Motion start	a detection tool triggered by the start of motion in an area of a video camera's field of view
Loitering	a detection tool triggered by the lengthy presence of an object in an area of a video camera's field of view
Object disappearance	a detection tool triggered by the disappearance of an object in an area of a video camera's field of view
Abandoned object	a detection tool triggered by the appearance of an abandoned object in an area of a video camera's field of view
Line crossing	a detection tool triggered by the trajectory of an object crossing a virtual line

Object appearance	a detection tool triggered by the appearance of an object in an area of a video camera's field of view
Stopping	a detection tool triggered by the cessation of motion in an area of a video camera's field of view

## Procedure for Configuring Situation Analysis Detection Tools

You can configure situation analysis detection tools as follows:

1. Enable situation analysis (disabled by default).
2. Set the general parameters.
3. Set common detection zones and/or masks.
4. Create objects for the required types of detection tools.
5. For each detection tool, set the virtual element (area or line) used for situation analysis.
6. Set detection parameters (only for loitering detection).
7. Check detection tool functioning with the help of the Triggers ribbon (optional, see the section [Checking the Triggering of a Detection Tool](#)).
8. For each detection tool, set rules to be automatically executed when the detection tool is triggered (see the section titled [Configuring Automatic Rules](#)).

### Enabling Situation Analysis

To enable situation analysis, you must perform the following steps:

1. In the Detection Tools list, highlight a **Situation analysis** object (1) which offers a means of analyzing the situation in the field of view of the required video camera.

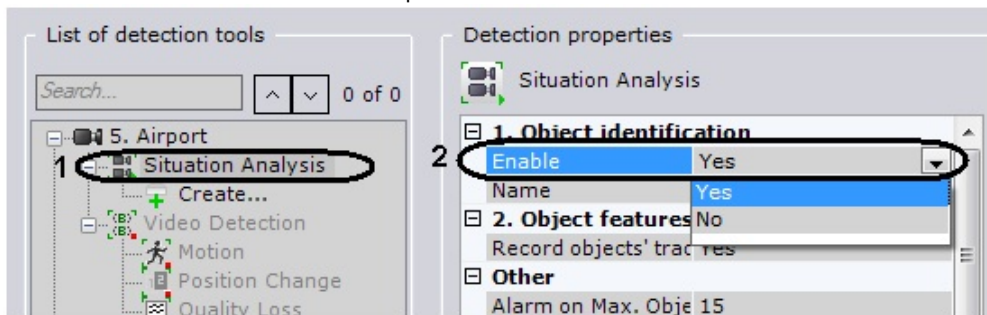

2. Select **Yes** from the **Enable** list (2).
3. Click the **Apply** button.



#### Note

After enabling situation analysis, the viewing tile will display the properties (width and height as percentages of the width and height of the frame) of tracked objects

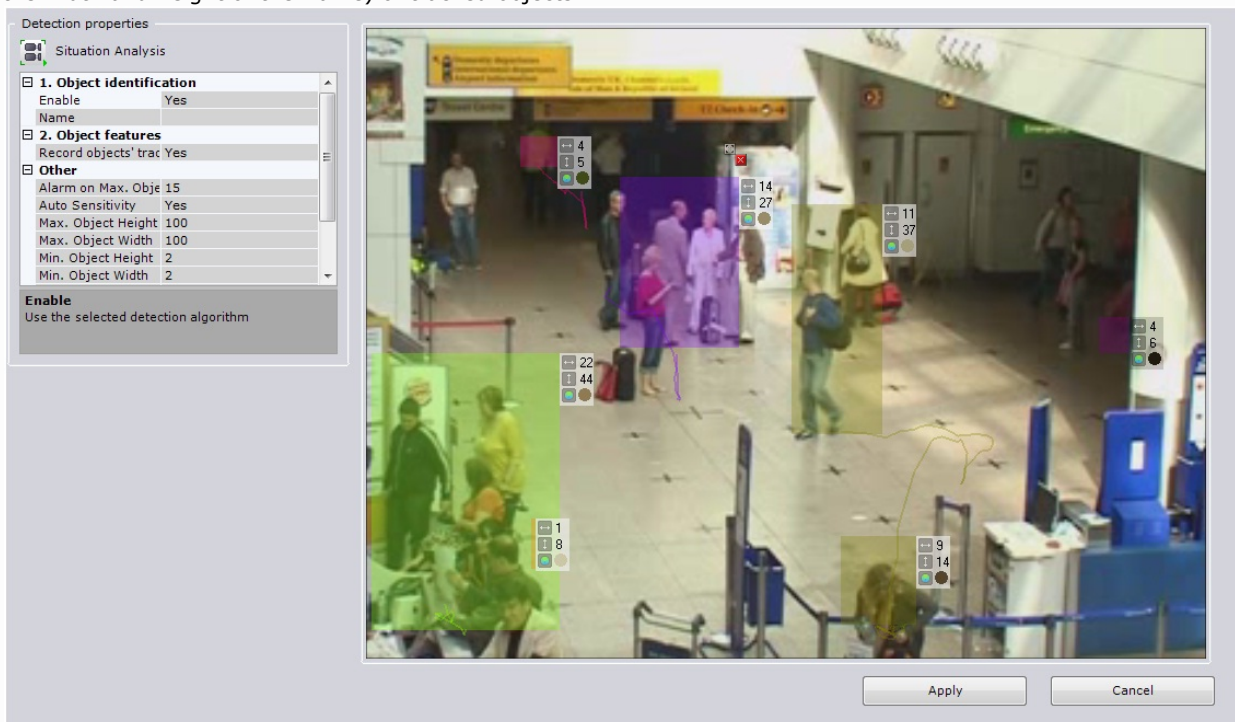

Situation analysis is now enabled.

## Setting General Parameters

To set a situation analysis detection tool's general parameters, you must perform the following steps:

1. In the Detection Tools list, highlight a **Situation analysis** object (1) which offers a means of analyzing the situation in the field of view of the required video camera.

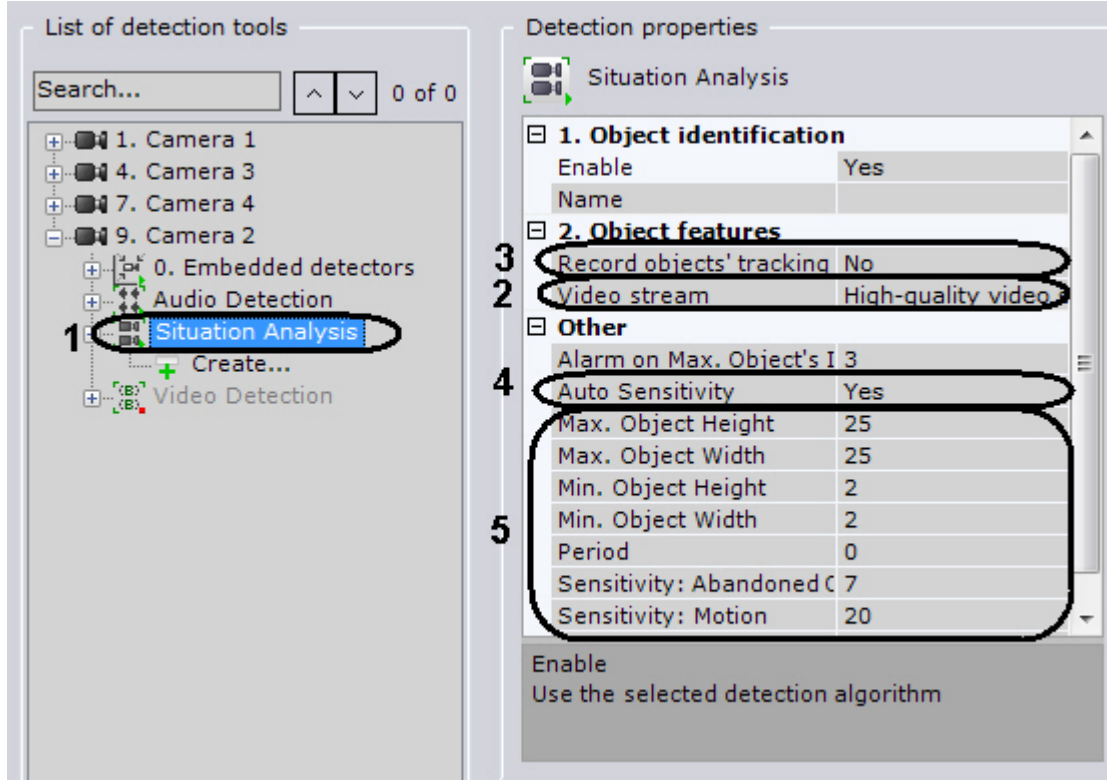

2. If a video camera supports multistreaming, select the stream for which detection is needed (2). Selecting a low-quality video stream allows reducing the load on the Server.
3. If you need to enable recording of video stream metadata, select **Yes** from the **Record object tracking** list (3).
4. If you require automatic adjustment of the sensitivity of scene analytic detection tools, in the **Auto Sensitivity** list, select **Yes** (4).



### Note

Enabling this option is recommended if the lighting fluctuates significantly in the course of the video camera's operation (for example, in outdoor conditions)

5. In the **Maximum height** and **Maximum width** fields (5), enter the maximum height and width of a detectable object as a percent of the height of the video image frame. The values should be in the range [2, 100].
6. In the **Max Rest Time** field (5), enter the maximum rest time of an object in seconds, after which it is considered abandoned. This value should be in the range [3, 1200].



### Note

This setting is relevant for an abandoned object detection tool



### Note

It is recommended to start by setting the value of this parameter at 10

7. In the **Minimum height** and **Minimum width** fields (5), enter the minimum height and width of a detectable object as a percent of the height of the video image frame. The values should be in the range [2, 100]. In the **Period** field (5), enter the time in milliseconds. This is the period of time after which the next video frame will be analyzed. This value should be in the range [0, 65535]. If the value is **0**, each frame of the video image is analyzed.
8. In the **Sensitivity: motion** field (5), set the sensitivity for motion detection tools, on a scale of 1 to 80.
9. In the **Sensitivity: abandoned object** field (5), set the sensitivity for situational analytic tools for abandoned objects, on a scale of 5 to 30.



### Note

These parameters depend on the lighting conditions and should be chosen empirically. It is recommended to start by setting the sensitivity at 20

10. Click the **Apply** button.

The general parameters of the situation analysis detection tools are now set.

## Setting Common Detection Zones

You can set a detection zone that is common to all situation analysis detection tools.

Detection zones are analyzed by all situation analysis detection tools. By default, the entire frame is a detection zone.

If you need to exclude complex zones in the camera field of view from analysis (leaves, water, etc.), set the detection zone as needed. To do this, follow the steps below:

1. In the Detection Tools list, highlight a **Situation analysis** object (1) that offers a means of analyzing the situation in the field of view of the required video camera.

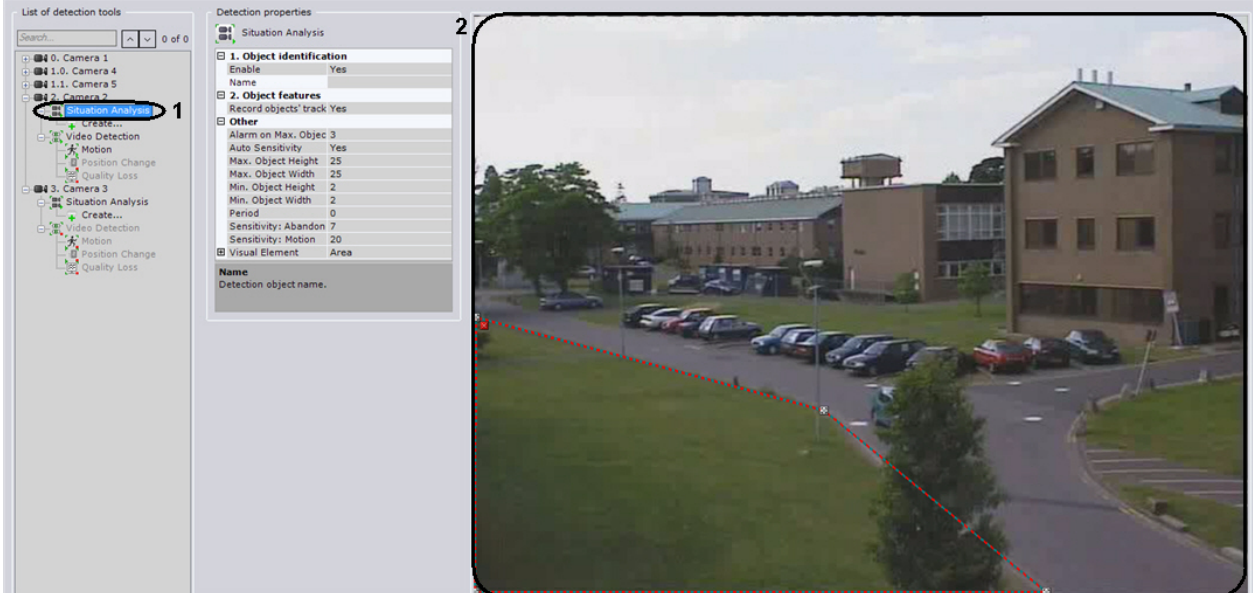

2. In the viewing tile (2), set the nodes of the closed area, in order, inside of which you want detection to be performed.



### Note

When the area is being constructed, the nodes are connected by a two-color dotted line which outlines the area's borders

Action	Result
Left-click in the viewing tile	Creates a new area node
Right-click on a line	
Right-click on a created node	Deletes the area node
Position the cursor on a node and hold down the left mouse button while you move the mouse	Moves the area node
Click the  button.	Deletes the area



### Attention!

You can set only one enclosed area.

3. Click the **Apply** button.

Creation of the detection zone is now complete.

## Creating a Detection Tool object

To activate the needed type of situation analysis detection, you must create the corresponding object (see the section titled [Types of Situation Analysis Detection Tools](#)).

To create a Detection Tool object, you must perform the following steps:

1. In the branch of the **Situation analysis** object which offers a means of analyzing the situation in the desired video camera's field of view, click **Create**.

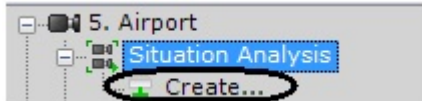

2. Highlight the **Select detection type** link which appears (1).

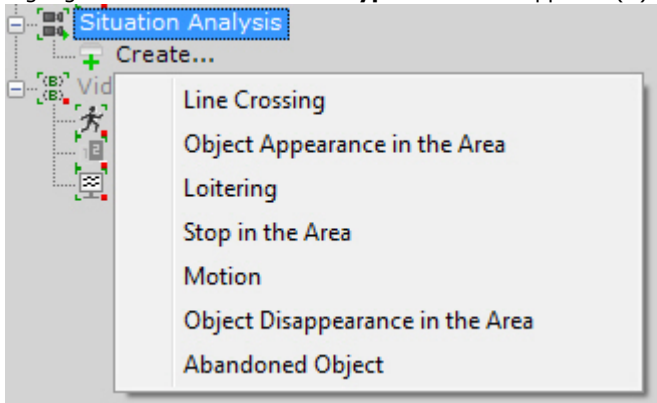

3. Click the **Apply** button.

Creation of the Detection Tool object is now complete.

## Setting Virtual Elements

On page:
<ul style="list-style-type: none"> <li>• <a href="#">Line</a></li> <li>• <a href="#">Area</a></li> </ul>

For each type of situation analysis detection tool you must set a virtual element of one of two types:

1. A line
2. An area

**Attention!**  
If no visual element is set, the detection tool will not work

The type of visual element is determined by the detection type. Only the **Line crossing** detection requires you to set a **Line** element. Other situation analysis detection tools require you to set an **Area** element for each detection tool.

### Line

The **Line** visual element sets a virtual line in the field of view of a video camera; when something crosses this line, it triggers the Line Crossing detection tool.

To set a line, you must perform the following steps:

1. In the list of detection tools, highlight a **Line Crossing** object (1).

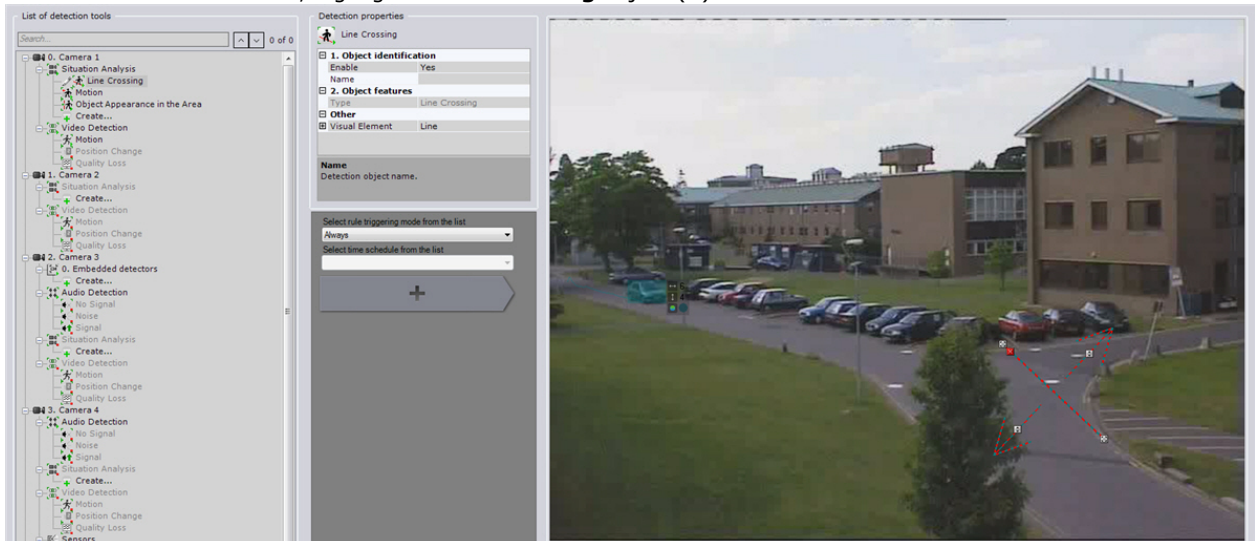

2. In the viewing tile (2), set the endpoints of the line which, when intersected, will trigger Line Crossing detection.

**Note**

When the line is being constructed, the end points are connected by a two-color dotted line. The direction of the object's motion across the line is indicated by dotted arrows (2)

Action	Result
Left-click in the viewing tile	Creates a line end point
Position the cursor on an end point and, holding down the left mouse button, move the mouse	Moves the line end point
Click the button 	Deletes the line

- By default, Line Crossing detection monitors object motion across the line in both directions. To suspend detection of motion in one direction, click the button corresponding to that direction.

**Attention!**

At least one direction must be selected for detection

**Note**

An unmonitored direction of object motion is indicated by a dimmed arrow

- Click the **Apply** button.

The line is now set.

### Area

The **Area** visual element sets an area of a video camera's field of view, in which the situation is analyzed by a detection tool of the selected type.

To set an area, you must perform the following steps:

- In the Detection Tools list, highlight the Detection Tool object for which you need to set an area (1).

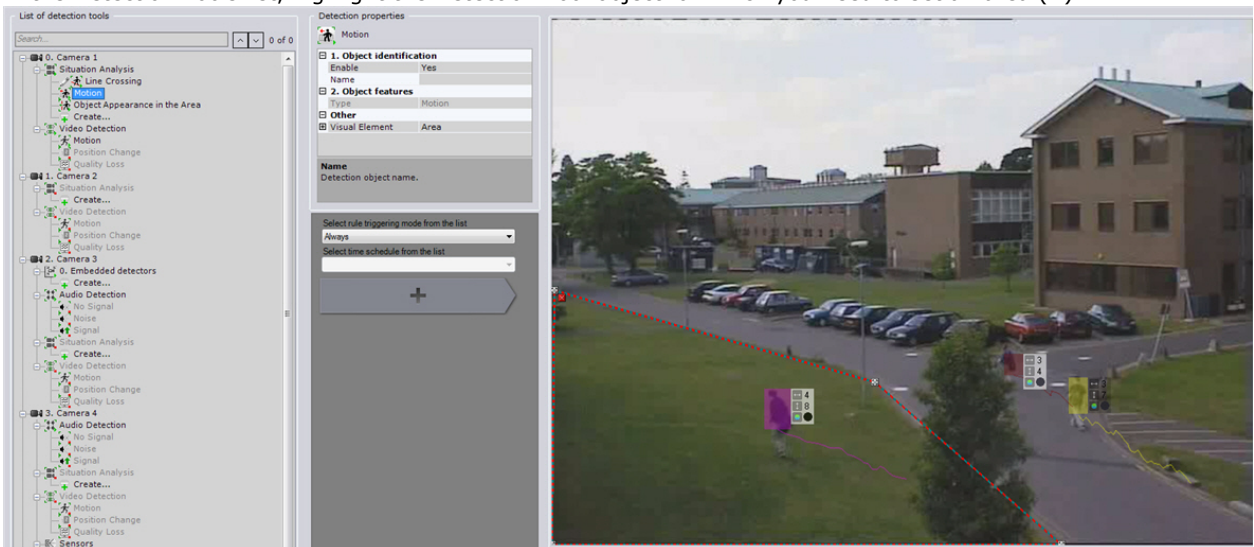

- In the viewing tile (2) set the nodes of the area, in order, in which the situation requires analysis.

**Note**

When the area is being constructed, the nodes are connected by a two-color dotted line which outlines the area's borders

Action	Result
Left-click in the viewing tile	Creates a new area node
Right-click on a created node	Deletes the area node
Position the cursor on a node and hold down the left mouse button while you move the mouse	Moves the area node
Click the button 	Deletes the area

3. Click the **Apply** button.

The area is now set.

## Settings Specific to Loitering Detection

When configuring the Loitering detection tool, you must set the maximum time an object can be in the analyzed area: when the maximum time is exceeded, the detection tool is triggered. To set a maximum time, you must perform the following steps:

1. In the Detection Tools list, highlight a **Loitering** object (1).

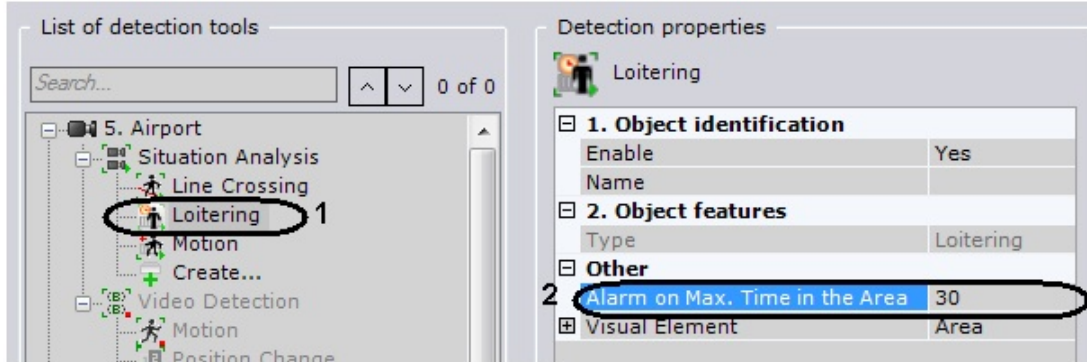

2. In the **Maximum loitering time** field (2), enter the maximum object loitering time in seconds. This value should be in the range [0, 3600].
3. Click the **Apply** button.

The maximum loitering time is now set.

## Video Analytic

### Types of Video Detection

The following detection tools enable analysis of the video image from a camera.

Name of a Detection Tool object	Detection description
Loss of quality	a detection tool which is triggered when the video image received from a video camera loses quality
Motion	a detection tool triggered by motion in a video camera's field of view
Position change	a detection tool triggered by a change in the video image background indicating a change in the video camera's position in space.

### Procedure for Configuring Video Detection

For each video camera, video detection tools of all three types are automatically created (see the section titled [Types of Video Detection](#)).

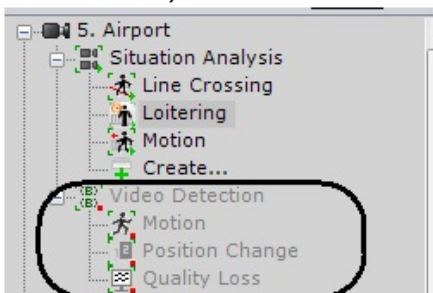

You can configure video detection tools as follows:

1. Enable video detection (disabled by default).
2. Set the general video detection tool properties.
3. Enable the desired video detection tools (all are disabled by default).
4. Configure the motion detection.



#### Note

The loss of quality and position change detection tools do not require configuration

5. Check detection tool functioning with the help of the Triggers ribbon (optional) (see the section [Checking the Triggering of a Detection Tool](#)).

- For each detection tool, set rules to be automatically executed when the detection tool is triggered (see the section titled **Configuring Automatic Rules**).

## Enabling Video Detection

To enable video detection, you must perform the following steps:

- In the Detection Tools list, highlight a **Video Detection Tool object** which offers a means of analyzing the video image from the desired video camera.

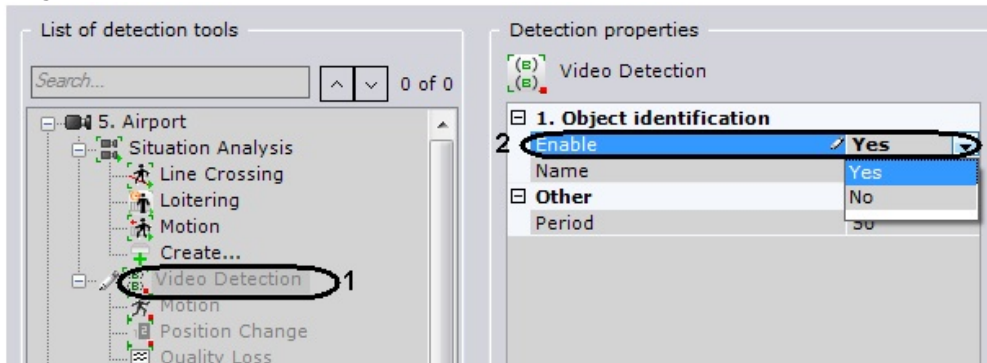

- Select **Yes** from the **Enable** list.
- Click the **Apply** button.

Video detection is now enabled.

The desired video detection tools may be enabled in the same way as video detection.

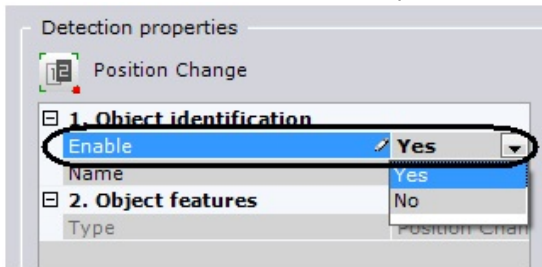

## Setting General Parameters of Video Motion Detection

To set the general parameters of video detection tools, you must perform the following steps:

- In the Detection Tools list, highlight a **Video Detection Tools** object (**1**) which offers a means of analyzing the video image from the desired video camera.

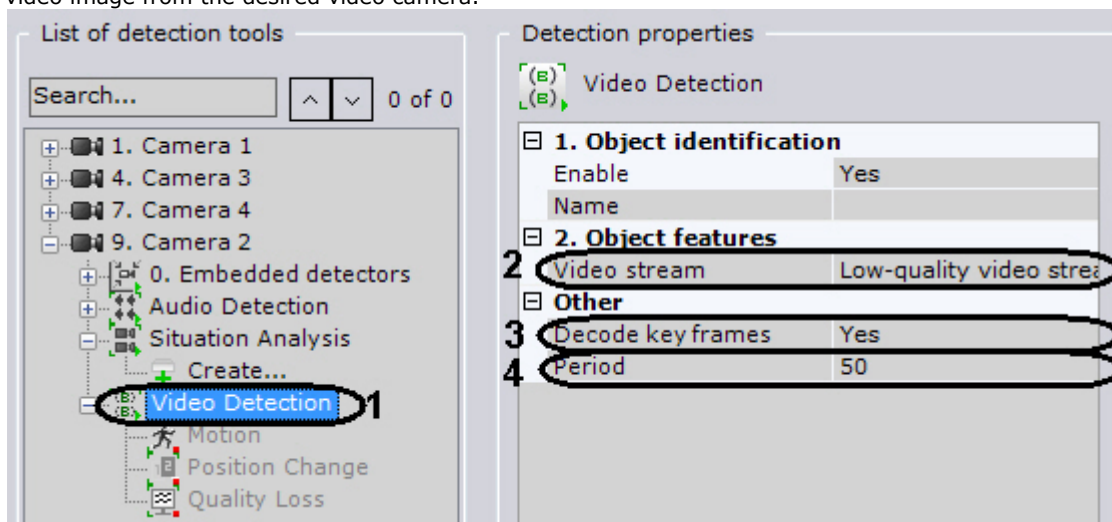

- If a video camera supports multistreaming, select the stream for which detection is needed (**2**). Selecting a low-quality video stream allows reducing the load on the Server.
- If it is necessary to decode frames every 500 milliseconds or less often, in the **Decode keyframes** list, select **Yes** (**3**).



### Important

This setting applies to all codecs. If a codec has keyframes and p-frames, the keyframe is decoded no more often than every 500 milliseconds.

This feature reduces the Server load but, as can be expected, negatively impacts the quality of detection.

This setting should be activated on "blind" Servers (Servers that do not display video) on which it is necessary to perform detection.

- In the **Period** field (4) enter the time in milliseconds after which the next video image frame will be processed. This value should be in the range [0, 65535]. If the value is **0**, each frame of the video image is processed.
- Click the **Apply** button.

Setting the general parameters of the video detection tools is now complete.

## Settings Specific to Video Motion Detection

To configure VMD, you must perform the following steps:

- In the Detection Tools list, highlight a **Motion** object (1).

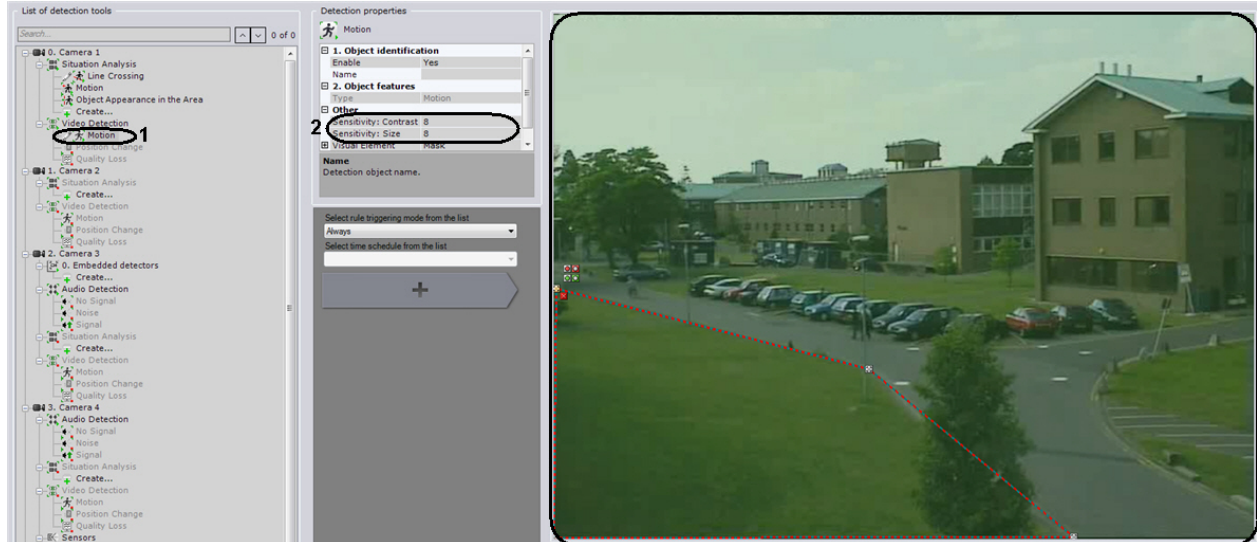

- In the **Sensitivity** field: contrast (2), enter the sensitivity of the detection tool to object contrast. You should select a value empirically in the range [0, 16]. The greater the value, the less contrastive the objects which can be detected.
- In the **Sensitivity** field: size (2), enter the sensitivity of the detection tool to object size. You should select a value empirically in the range [0, 10]. The greater the value, the smaller the objects which can be detected.
- In the viewing tile, set detection zones and/or masks in the same way as for situation analysis detection tools (3).



### Note

See steps 2–4 in the section [Setting Common Detection Zones](#)

- Click the **Apply** button.

VMD configuration is now complete.

## Audio analytics

[Play corresponding video](#)

### Types of Audio Detection

The following detection tools enable analysis of the audio signal from a microphone.

Name of a Detection Tool object	Detection description
No signal	A detection tool which is triggered by the absence of an audio signal from an audio device
Signal	A detection tool which is triggered by the reception of an audio signal from an audio device
Noise	A detection tool which is triggered by the appearance of noise



### Attention!

No Signal audio detection may operate incorrectly with video cameras emitting a background signal with a non-zero volume, even if the integrated microphone is physically disabled

### Procedure for Configuring Audio Detection

For each video camera equipped with one or more audio ports, audio detection tools of all three types are automatically created (see the section titled [Types of Audio Detection](#)).

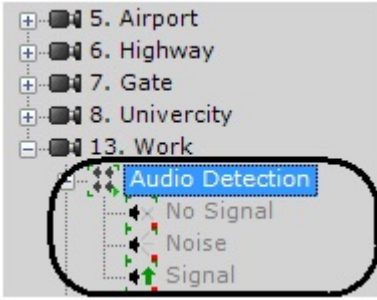

You can configure audio detection tools as follows:

1. Set the general audio detection parameters.
2. Enable the desired audio detection tools (all are disabled by default).
3. Configure the Noise and Signal detection tools.

**Note**  
The No Signal detection does not require configuration

4. Check detection tool functioning with the help of the Triggers ribbon (optional) (see the section [Checking the Triggering of a Detection Tool](#)).
5. For each detection tool, set rules to be automatically executed when the detection tool is triggered (see the section titled [Configuring Automatic Rules](#)).

## Enabling Audio Detection

To enable audio detection, you must perform the following steps:

1. In the list of detection tools, highlight the necessary audio detection tool (1).

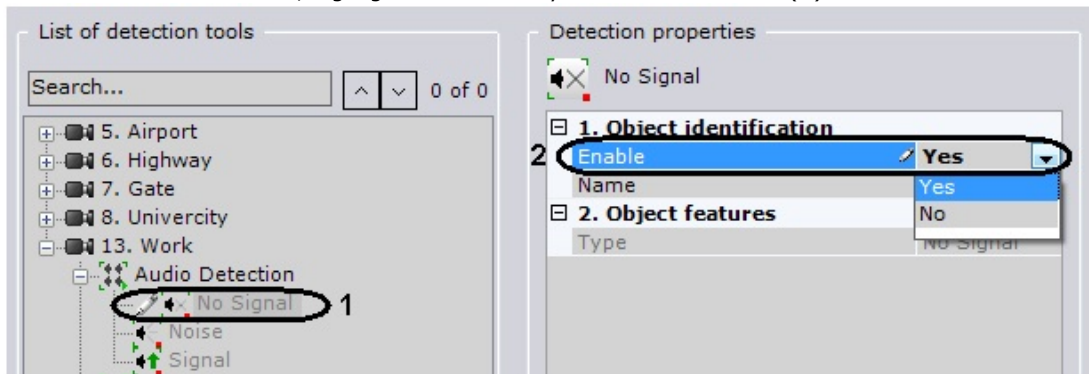

2. Select **Yes** from the **Enable** list (2).
3. Click the **Apply** button.

The audio detection tool is now enabled.

## Setting General Parameters of Audio Detection

To set the general parameters of audio detection tools, you must perform the following steps:

1. In the detection tool list, highlight an **Audio Detection object** (1) which offers a means of analyzing the audio signal from a microphone connected to the desired video camera.

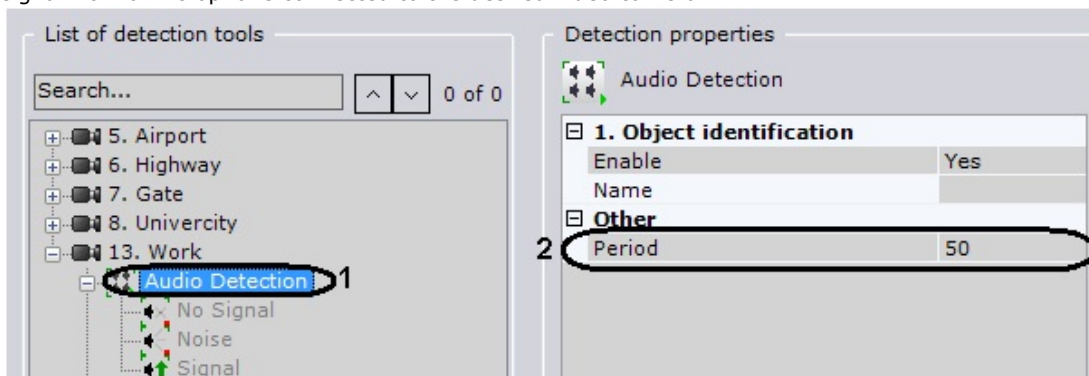

2. In the **Period** field (2), enter the time in milliseconds after which the next section of the audio stream will be processed by the audio detection tools. This value should be in the range [0, 65535]. If the value is **0**, each section

- of the audio stream is processed.
- 3. Click the **Apply** button.

Setting the general properties of the audio detection tools is now complete.

## Settings Specific to the Signal and Noise detections

To configure the Signal and Noise detection tools, you must perform the following steps:

1. In the Detection Tools list, highlight a **Signal** or **Noise** audio detection.

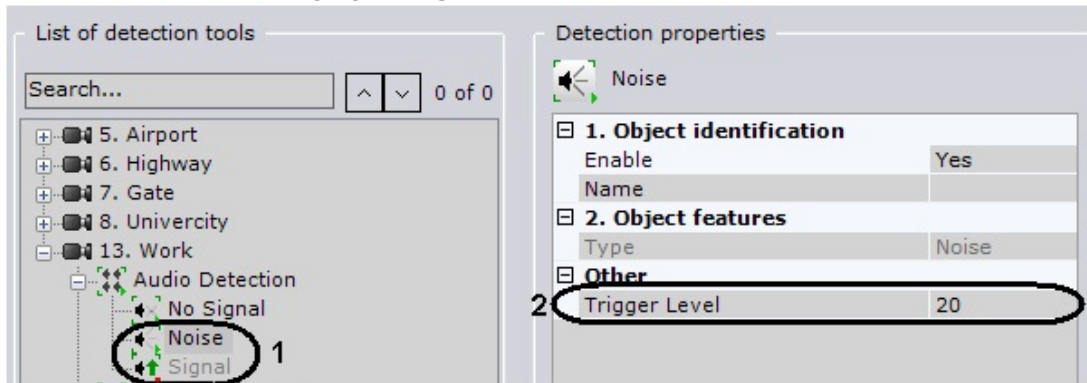

2. Enter the following values in the **Level** field:
  - a. When configuring the Signal detection tool, enter the audio signal level in standard units above which the detection tool will be triggered. You should select a value empirically in the range [0, 1000].
  - b. When configuring the Noise detection tool, enter the noise level in standard units above which the detection tool will be triggered. You should select a value empirically in the range [0, 1000].
3. Click the **Apply** button.

Configuration of the Signal and Noise detection tools is now complete.

## Embedded Analytics

At the moment of writing of this documentation, the embedded analytics of Axis and Sony video cameras and Stretch cards have been integrated into the Axxon Next software package (if they support it; see the official reference documentation for these devices).

### How to configure on-board detection tools

You can configure on-board detection tools as follows:

1. Create a detection tool object.
2. Set the detection tool parameters.
3. Check triggering of the detection tool with the help of the Triggers ribbon (optional) (see the section [Checking the Triggering of a Detection Tool](#)).
4. Set the rules to be automatically executed when the detection tool is triggered (see the section titled [Configuring Automatic Rules](#)).

### Creating an on-board detection tool object

To create an on-board detection tool object, you must perform the following steps:

1. In the branch of the **Embedded Analytics object** which offers a means of analyzing the video image in the desired Sony Ipela video camera, click **Create (1)**.

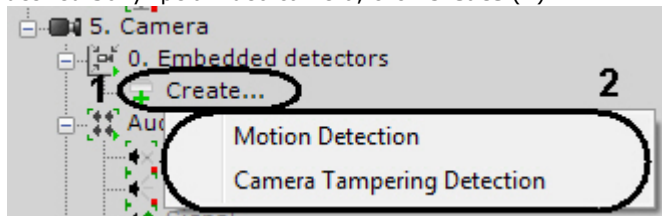

2. In the list that appears (2), select the type of embedded detection tool.
3. Click the **Apply** button.

When you do this, an **Intelligent detection** object appears in the Detection Tools list.

Creation of a Sony Ipela detection object is now complete.

### Configuring a Sony Ipela detection tool

This section contains an example of configuring Sony Ipela Embedded Analytics. When configuring the embedded analytics of other devices, you should use their descriptions in the interface of the software package or, for more detail, the official reference documentation for these devices.

To configure a Sony Ipela detection tool, you must perform the following steps:

1. In the list of detection tools, highlight an **Intellectual detection** object (1).

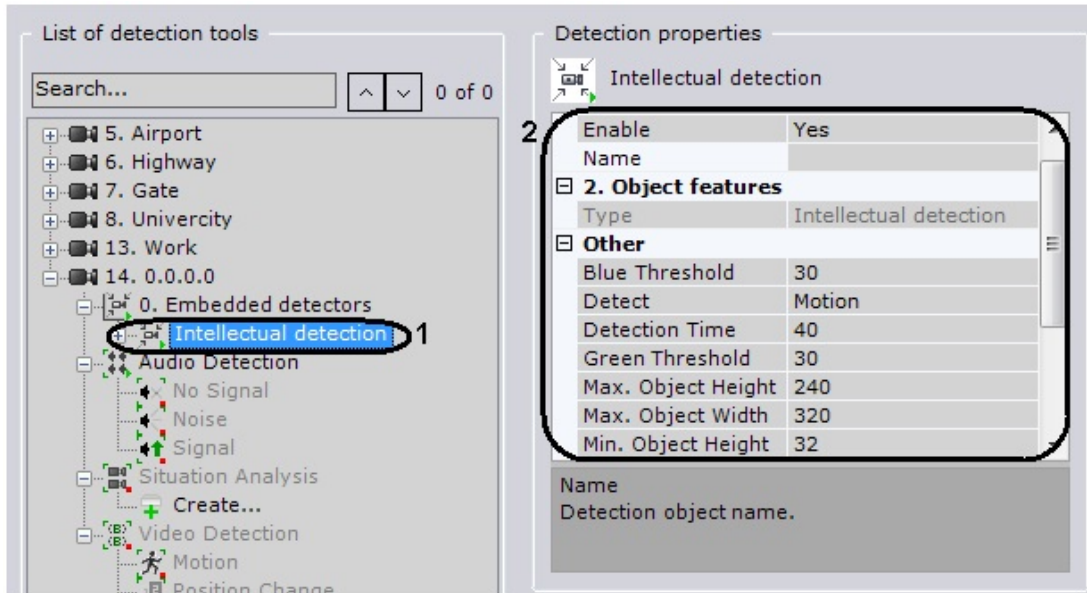

2. From the **Detect** list, select the desired detection mode: **Motion** or **Abandoned object** (2).
3. If you selected motion detection (**Motion** in the **Detect** list), set the following parameters (2):
  - a. To enable the mode in which the detection tool also responds to stopping, select **Yes** in the **Respond to stopping** list.
  - b. In the **Rest time** field, indicate in seconds the rest time of an object after which the motion detection tool registers stopping (if you executed step 3.1). This value should be in the range [2, 60].
  - c. In the **Green threshold** field, enter the saturation level of the green RGB component in the image of a moving object above which the detection tool is triggered. This value should be in the range [0, 99].
  - d. In the **Red threshold** field, enter the saturation level of the red RGB component in the image of a moving object above which the detection tool is triggered. This value should be in the range [0, 99].
  - e. In the **Blue threshold** field, enter the saturation level of the blue RGB component in the image of a moving object above which the detection tool is triggered. This value should be in the range [0, 99].



**Note**

The threshold saturation of the RGB component in the image of a moving object determines the sensitivity of the detection tool. It is advisable to change the saturation of all components at the same time (see steps 3.3 – 3.5)

4. If you selected abandoned object detection (**Abandoned object** in the **Detect** list), set the following parameters (2):
  - a. In the **Start of detection** field, indicate the length of time in standard units an object remains in view before it is detected. This should be selected empirically. This value should be in the range [3, 7].
  - b. In the **Detection time** field, enter the rest time of an object in seconds, as counted from the beginning of detection (see step 4.1), after which it is considered abandoned. This value should be in the range [40, 43200].
  - c. In the **Realarm time** field, enter in seconds the time since the last alarm about an abandoned object after which a repeat alarm is generated (assuming that such an event occurs). This value should be in the range [60, 21600].
  - d. In the **Release time** field, enter the length of time an abandoned object remains in view above which it will be considered part of the background. In this case, alarm generation ceases. This value should be in the range [60, 43200].
5. In the **Maximum height** and **Maximum width** fields (2) enter the maximum height and width of a detectable object in pixels. The height value should be in the range [8, 480] and the width value should be in the range [8, 640].
6. In the **Minimum height** and **Minimum width** fields (2) enter the minimum height and width of a detectable object in pixels. The height value should be in the range [8, 480] and the width value should be in the range [8, 640].
7. Click the **Apply** button.

Configuration of the Sony Ipela embedded detection tool is now complete.

## Sensors

After becoming enabled on the **Devices** tab, the **Sensor** object appears on the **Detection Tools** tab (see the section [The Sensor Object](#)).

Check the functioning of the sensor in the **Devices** tab (see the section [The Sensor Object](#)). The **detection properties** field in the **Detection Tools** tab duplicates the settings entered in the **Devices** tab under **Settings** and is not editable.

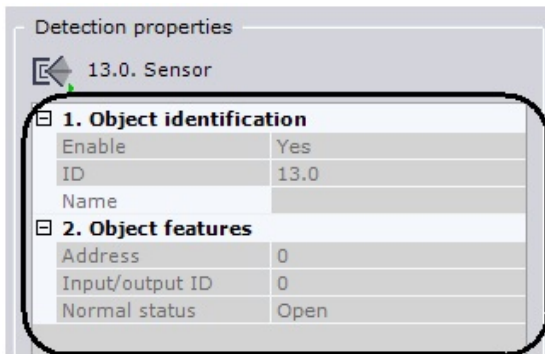

Perform the follow actions for the **Sensor detection tool**, on the **Detection Tools tab**:

1. Check triggering of the detection tool with the help of the Triggers ribbon (optional) (see the section [Checking the Triggering of a Detection Tool](#)).
2. Set the rules to be automatically executed when the detection tool is triggered (see the section titled [Configuring Automatic Rules](#)).

## Checking the Triggering of a Detection Tool

You can check the triggering of detection tools in the **Detection Tools tab**.

To use this option you must perform the following steps:

1. In the Detection Tools list, highlight the detection tool object whose triggering you need to check.



### Attention!

The Detection Tool object should be enabled and configured

2. Produce an event whose occurrence should trigger the detection tool: motion in the frame, turning the video camera, providing sound to an audio device, etc.
3. If the detection tool is configured correctly, video image frames from the video camera corresponding to the detection tool will be displayed on the trigger ribbon with the time they were received indicated.



Checking the triggering of a detection tool is now complete.

## Configuring Automatic Rules

Automatic rules are particular actions that are performed when a detection tool is triggered. One or multiple automatic rules can be set for each detection tool.

The interface for configuring automatic rules is shown when any detection tool is selected:

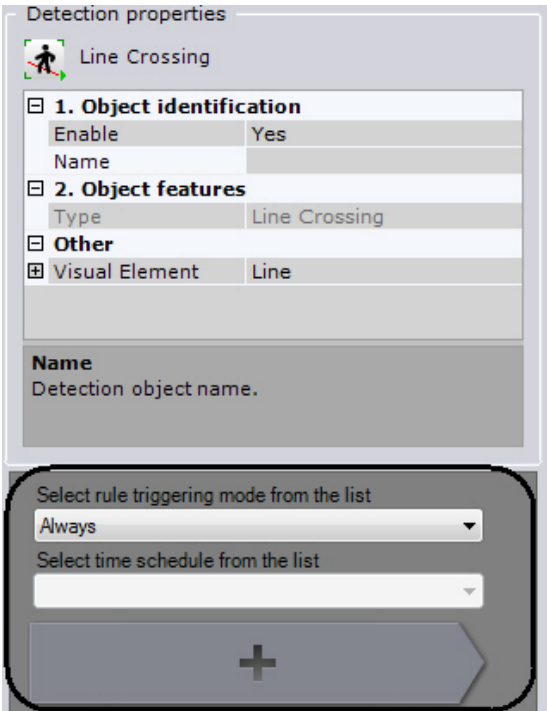

## Types of Automatic Rules

When a detection tool is triggered, one or more rules may be executed:

1. Recording to the archive and initiation of an alarm in the system.
2. Switching to the layout with the minimum number of cells to display the selected video camera.
3. Starting an external program on Clients.
4. Switching a relay.
5. Switching to a PTZ camera preset.
6. Sound notification.
7. E-mail notification.
8. SMS notification.

## Automatic Rule Execution Modes

You can select the execution mode of all automatic rules set for a video camera's detection tool.

The rules can be executed in one of three modes:

1. Always.
2. Processing only in the armed mode.
3. Within time schedule.

The mode for performing automatic rules is selected from the corresponding list **(1)**.

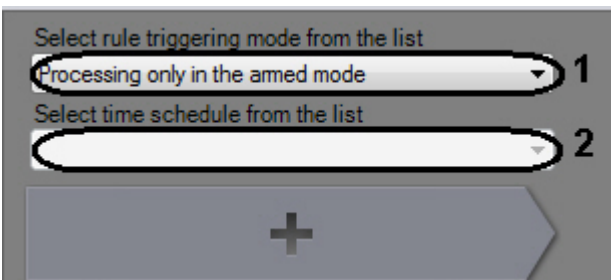

If **Within time schedule** mode is chosen, select a schedule **(2)**.

## Adding an automatic rule

To add an automatic rule, click the **plus** button **(1)** and select the type of automatic rule from the list **(2)**.

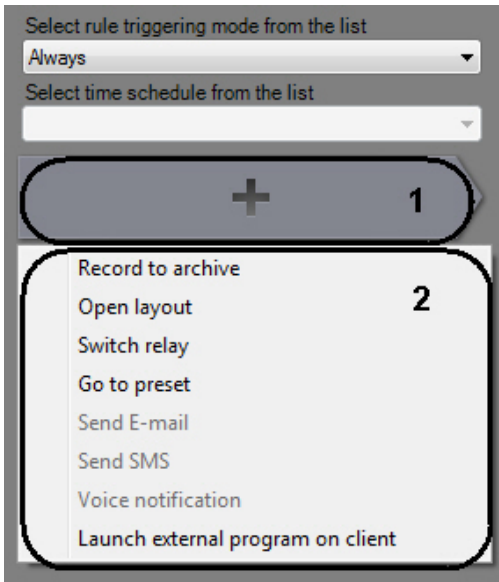

**Note**

To add most automatic rules, certain conditions have to be met (see [Conditions for Setting Automatic Rules](#)).

The selected automatic rule is then displayed:

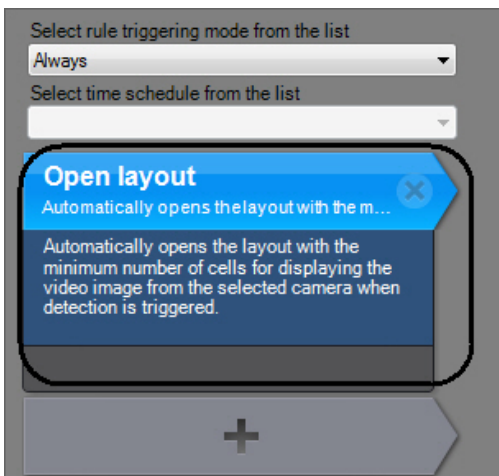

To save the automatic rule, click the **Apply** button.

To add other automatic rules, repeat the original procedure.

**Note**

To delete an automatic rule, click the  button and click the **Apply** button to save changes

## Conditions for Setting Automatic Rules

Before setting automatic rules to be executed when a detection tool is triggered, you must make sure that the following objects have been created and configured.

Automatic Rule	Object which must be configured
Recording to Archive and Initiation of an Alarm	Archive
Switch to the layout with the minimum number of cells to display the selected video camera	-
Switching Relays	Relay
Switching to a PTZ camera preset	Telemetry (you must set the presets using the PTZ device control panel)
Audio notification	Speaker

E-mail notification	E-mail
SMS notification	SMS
Launching an external program on clients	-

If a condition for setting an automatic rule is not met, the rule cannot be selected for adding:

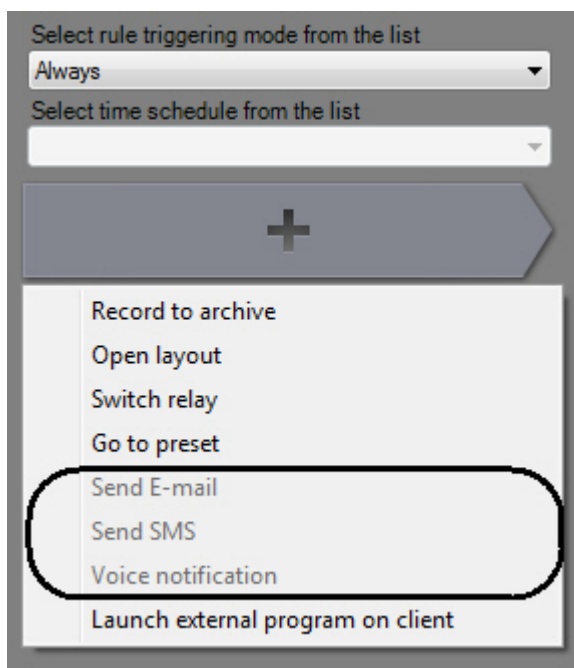

## Recording to Archive and Initiation of an Alarm

To configure recording to the archive and the initiation of an alarm when a detection tool is triggered, you must perform the following steps:

1. Add the **Record to archive** rule (see Adding an automatic rule).

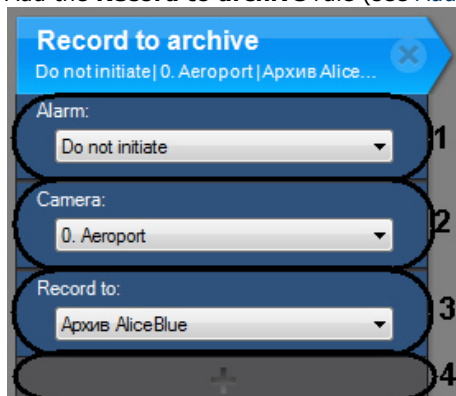

2. In the **Alarm** list (1), select the mode for initiating a system alarm.
3. In the **Camera** list (2), select the video camera for which the rule will be performed.
4. In the **Record to** list (3), select the archive to which you need to record the video image (and audio signal, if configured accordingly) when the detection tool is triggered.



### Attention!

Recording from the detection tool video camera to this archive must be setup (see the section [Configuring Recording of the Video Stream from Video Cameras to the Archive](#))

5. Click the **plus** button (4), then add and configure additional rule settings:

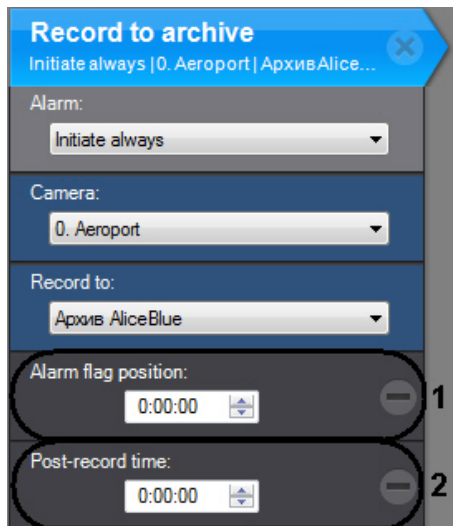

- a. In the **Alarm flag position** field (1), enter the number of seconds by which the alarm flag will be shifted back from the actual time the alarm was triggered.

**Note**  
If the alarm flag position is set, playback of an event received for processing begins from the moment corresponding to the flag's position, and not from the moment of the beginning of the alarm

- b. In the **Post-record time** field (2), enter the post record time, which is the length in seconds of post-alarm recording which will be added to the end of the recording made in connection with the alarm. The post record time is counted from the moment of the end of the alarm and is observed only if the alarm is evaluated by the operator before the end of the given time. If the alarm is evaluated by the operator or automatically after the end of the post record time, the recording ends at the moment of evaluation of the alarm.

**Note**  
Post-alarm time is 0 seconds by default

**Note**  
For example, let's say that the post record time is 2 minutes. An alarm is registered. If the operator evaluates the alarm before it is over or within 2 minutes of the moment it ended, the recording will end exactly 2 minutes from the moment the alarm ended. If the alarm is evaluated by the operator or automatically after two minutes have passed since the end of the alarm, the recording ends at the moment of evaluation of the alarm

6. To save changes, click the **Apply** button.

Configuration of recording to the archive and initiation of an alarm when a detection tool is triggered is now complete.

## Switching to the layout with the minimum number of cells to display the selected video camera.

To configure the system to switch to the layout with the minimal number of cells for displaying the specified video camera when a detection unit is triggered, you must perform the following steps:

1. Create the automatic rule **Open Layout** (see [Adding an automatic rule](#)).

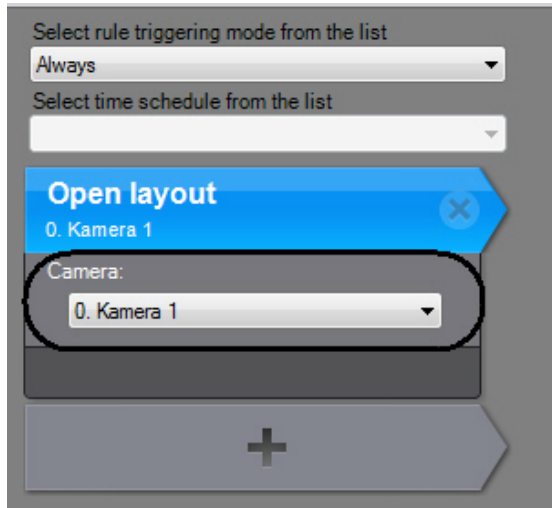

2. Select the video camera whose layout you need to switch to from the appropriate list.
3. To save changes, click the **Apply** button.

The following procedure will be used for displaying video cameras:

1. The system searches for layouts that contain the specified video camera and are accessible to the user.
2. The system chooses the layout with the minimum number of cells to display the selected video camera.
3. If the required layout does not yet exist, the system creates a new layout with a single video camera.
4. The system switches to the selected layout.
5. The video camera becomes active in the selected layout, and the viewing tile is expanded by one level.

## Launching an external program on clients

This automatic rule allows starting an external program on computers that are running Axxon Next Client.

The external program is started on all Clients that are connected to the domain.



### Attention!

The external program is not started on a computer that is an Axxon Next Server, if the Client is not running on the computer when the detection tool is triggered.

To launch an external program on all running clients when a detection tool is triggered:

1. Create a **Launch external program on Client** automatic rule.

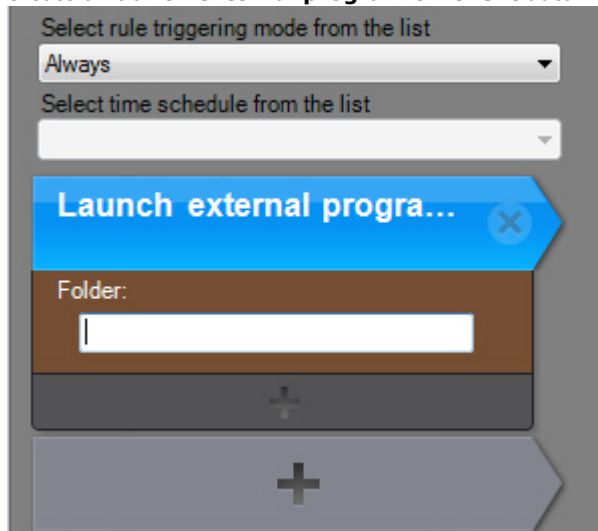

2. In the **Folder** field, specify the path to the executable file of the program that you want to launch. You can specify a network path here, if you want.
3. To configure additional parameters for launching the program, click the **plus** button and enter the necessary command-line arguments.

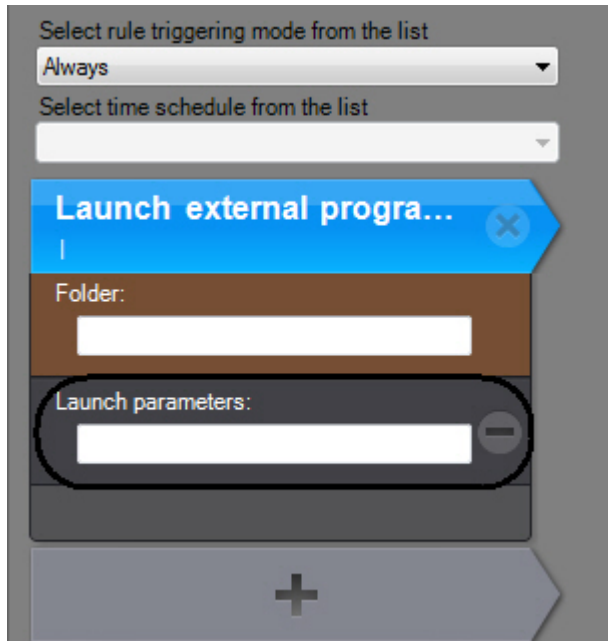

4. Click **Apply** to save the changes.

Configuration for launching an external program on running clients is now complete.



**Attention!**

By using this automatic rule, you can configure audio notifications on remote Clients. To do so, on the Clients, start any program that can play back an audio file. In the startup parameters, specify the notification file.

For example, let us consider Windows Media Player. For audio notifications on remote Clients via Windows Media Player, set the following parameters:

Path to the player: "C:\Program Files\Windows Media Player\wmplayer.exe";

Startup parameters: -vvv "<Path to notification file>"

The notification file can have either a local address on the Client or a network address.

An example configuration is shown in the figure:

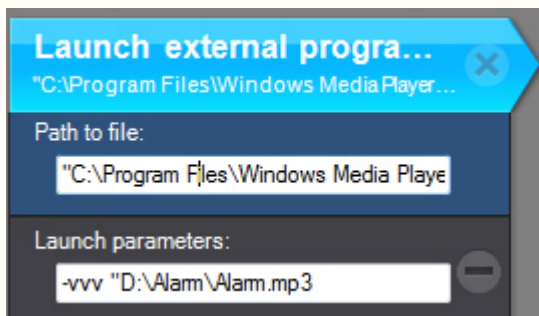

## Switching Relays



**Attention!**

Relays can be switched only in one direction: from normal condition to active.

To configure the switching of a relay when a detection tool is triggered, you must perform the following steps:

1. Add the **Switch relay** rule (see Adding an automatic rule).

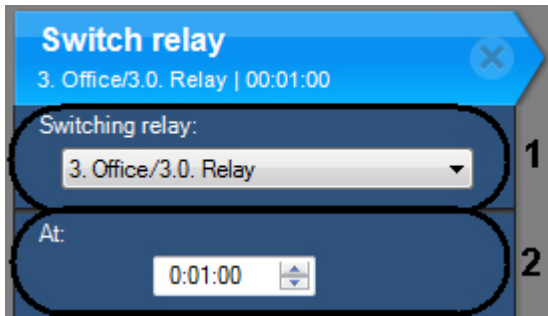

2. In the **Switching relay** list (1), select the **Relay** object corresponding to the relay which needs to be switched when the detection tool is triggered. Any enabled relay in the system can be used, including one tied to another server.
3. In the **At** field (2), enter the length of time for which the relay should be in switched status.
4. To save changes, click the **Apply** button.

Configuration of switching a relay when a detection tool is triggered is now complete.

## Switching to a PTZ camera preset

To configure switching to a PTZ camera preset, you must perform the following steps:

1. Add the **Go to preset** rule (see Adding an automatic rule).

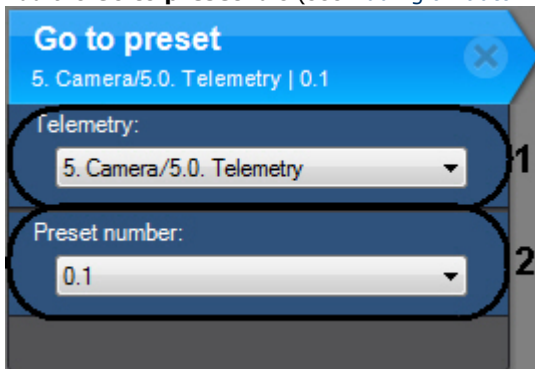

2. In the **Telemetry** list (1) select a **Telemetry** object that matches the PTZ device of the PTZ video camera. The pan/tilt unit of any PTZ camera can be used, including one tied to another server (if it is enabled).
3. In the **Preset number** list (2), select the number of the camera preset to which the camera should switch when the detection tool is triggered.
4. To save changes, click the **Apply** button.

Configuration of switching to a PTZ camera preset is now complete.

## Voice notification



### Attention!

Audio notifications cannot be played back via the system speakers on a remote Client. In this case, you are advised to create an automatic rule to [run an external program on Clients](#).

To configure voice notification when a detection tool is triggered, you must perform the following steps:

1. Add the **voice notification** rule (see Adding an automatic rule).

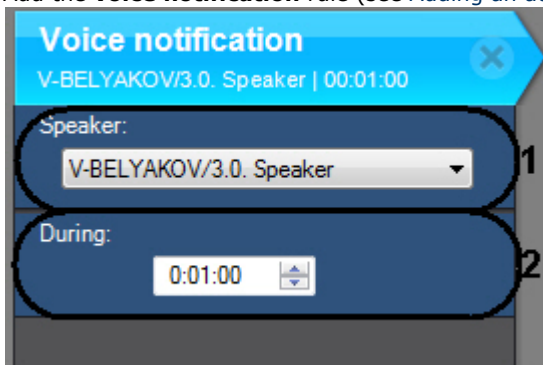

2. In the **Speaker** list (1), select the **Speaker** object corresponding to the speaker on which you wish to play the sound notification.
3. In the **During** field (2), enter the time in the format HH:MM:SS during which the sound notification is to be transmitted.
4. To save changes, click the **Apply** button.

Configuration of sound notification when a detection tool is triggered is now complete.

## E-mail notification

To configure e-mail notification when a detection tool is triggered, you must perform the following steps:

1. Add the **Send E-mail** rule (see Adding an automatic rule)..

2. In the **Select e-mail list** (1), select the **e-mail** object which will be used for e-mail notification when a detection tool is triggered.
3. In the **Message subject** field of the window which appears (2), enter the subject of the e-mail message which will be sent when the detection tool is triggered.
4. In the **E-mail text** field (3), enter the text which should be sent in an e-mail message when the detection tool is triggered.
5. To save changes, click the **Apply** button.

Configuration of e-mail notification when a detection tool is triggered is now complete.

## SMS notification

To configure SMS notification when a detection tool is triggered, you must perform the following steps:

1. Add the **Send SMS** rule (see Adding an automatic rule).

2. In the **Modem** list (1), select the **SMS** object which will be used for SMS notification when a detection tool is triggered.
3. In the **Message text** field of the window which appears (2), enter the text which should be sent in an SMS when the detection tool is triggered.
4. Go to another automatic rule, or click **Apply**.

Configuration of SMS notification when a detection tool is triggered is now complete.

## Configuring Archives

### General Information of Configuring Archives

You can configure archives using the interface in the **Archive** tab (under **Settings**). To create archives you must have the appropriate permissions.

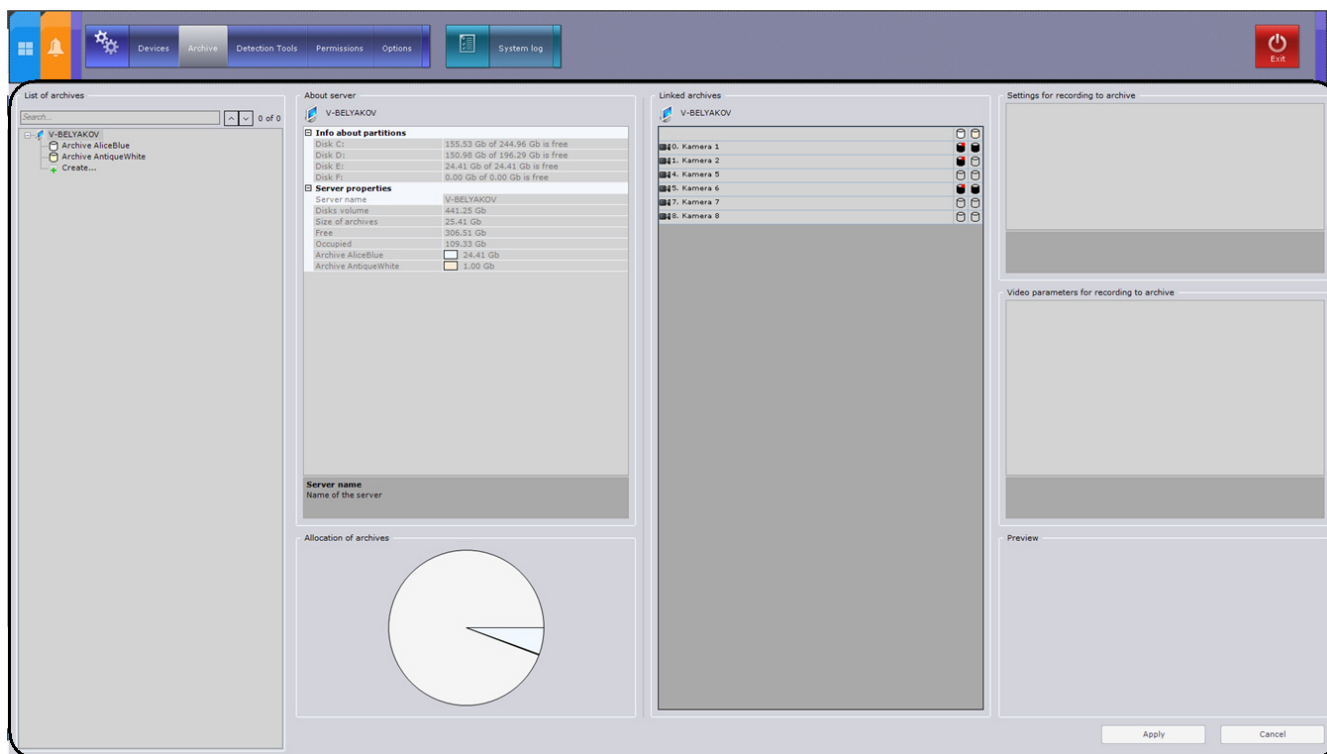

On the base of one server you can create an unlimited number of archives.

An archive can be distributed on several volumes of the server. On one volume for one archive you can create only one partition, which occupies either a file of a set size or the entire volume.



#### Attention!

Only local disks can be used for archives. Archives cannot be hosted on a network disk (NAS)).

You can create archives that will either fill up a file to a certain size limit or occupy an entire logical disk.

You can configure archives as follows:

1. Create archives.
2. Configure recording of the video stream from video cameras to the archives.

## Creating archives

### Creating a new archive as a file

To create an archive as a file:

1. In the branch of the **Server** object corresponding to the computer on which you need to organize an archive, click the **Create** link.

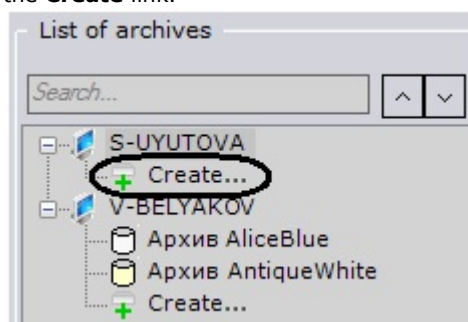

#### Note

You can also create an archive by selecting the matching command in the context menu of the **Server** object (the menu can be brought up by right-clicking the name of the Server)

2. Highlight the **New archive** link which appears (1).

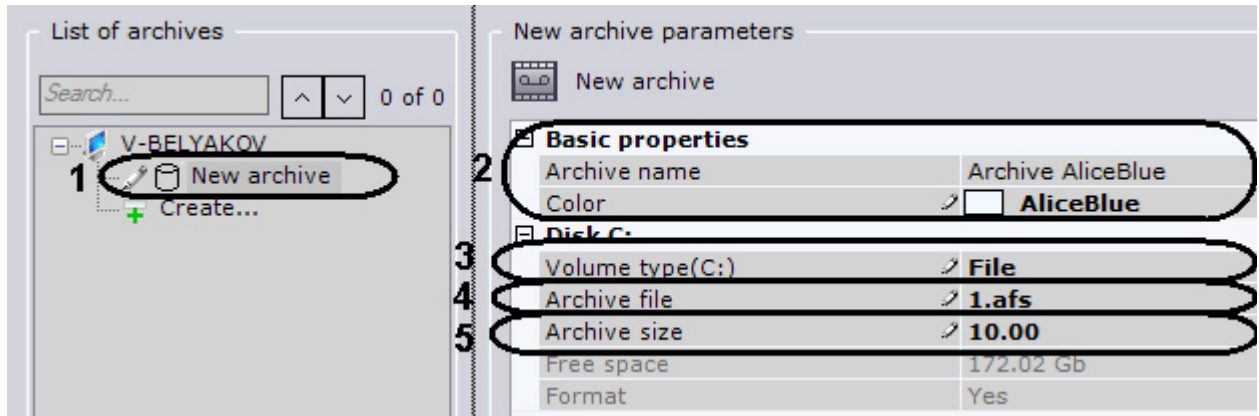

3. In the **Basic properties** group (2), identify the archive:
  - a. in the **Archive name** field, enter the desired archive name.
  - b. From the **Color** list, select a color to label the archive.
4. In the **Volume type** list, select **File** (3).



**Important!**

Saving an archive as a file can increase the load on the CPU if the file is created on a highly fragmented disk.

It is recommended to place the archive on an entire logical disk (see [Creating a new archive as a partition](#))

5. In the **Archive file** field, specify the place and name with which to save the archive file (4). The file will be created automatically.
6. In the **Archive size** field, enter the amount of disk space (in gigabytes) that is required for the archive file (5). The size of the archive file must be more than 1 GB.



**Important!**

If the archive is completely filled, the oldest data will be overwritten with new data.

7. If necessary, allocate other system disks to archive storage.
8. Click the **Apply** button.

Creation of an archive with the desired parameters is now complete.

The archive size relative to the total amount of space on system disks is displayed in the **Allocation of archives** chart.

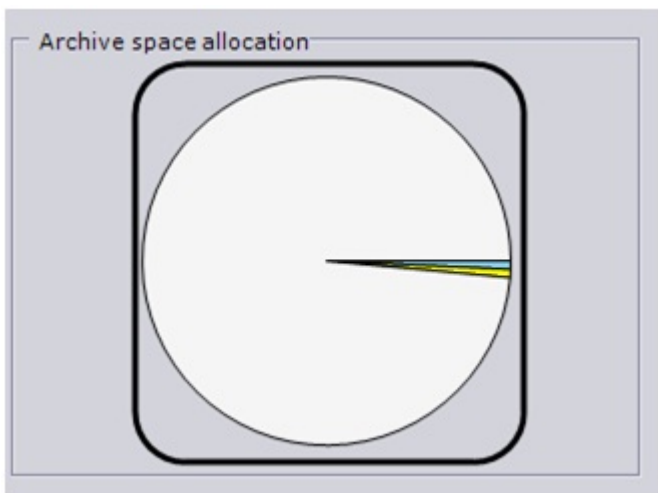

## Creating a new archive as a partition

To create an archive as a partition:

1. In the branch of the **Server** object corresponding to the computer on which you need to organize an archive, click the **Create** link.

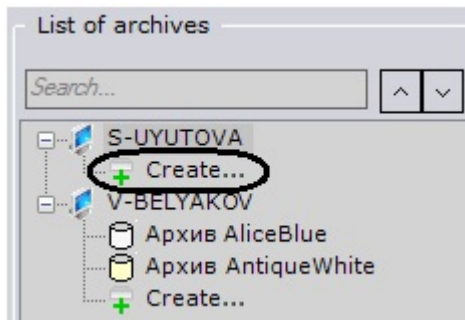

**Note**  
You can also create an archive by selecting the matching command in the context menu of the **Server** object (the menu can be brought up by right-clicking the name of the Server)

- Highlight the **New archive** link which appears (1).

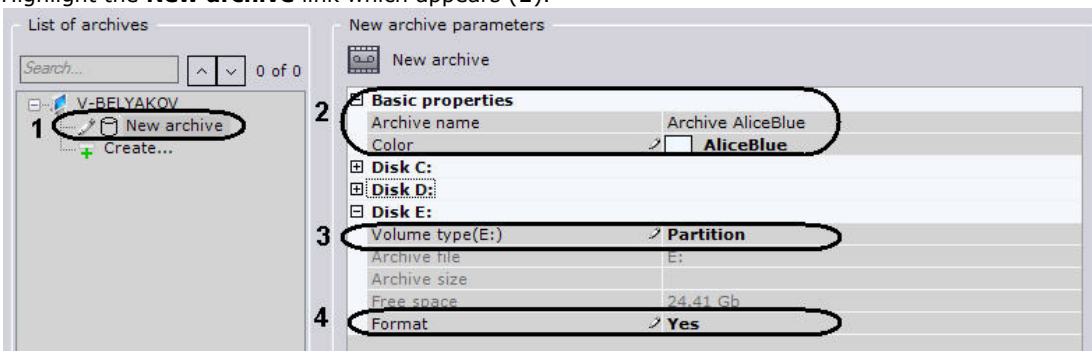

- In the **Basic properties** group (2), identify the archive:
  - in the **Archive name** field, enter the desired archive name.
  - From the **Color** list, select a color to label the archive.
- Manually delete the file system on the disk on which you want to place the archive, by using the standard Disk Management utility in Windows. Instructions for starting and using the utility are given on the [Microsoft website](#).

**Important!**  
When selecting the disk on which to place the archive, take the size of the archive into account. If the archive is completely filled, the oldest data will be overwritten with new data.

**Note**  
Deleting the file system on the disk in the disk management utility consists of the following:

- Delete the volume.
- Create a new volume in the resulting unformatted area.
- Assign a letter to the volume, but do not format it.

The system disk cannot be completely allocated for an archive

**Note**  
Note that you cannot delete a partition on a removable disk in Disk Manager

- In the **Volume type** list, select **Partition** (3).
- In the **Format** list, select **Yes** (4). This choice allows reformatting the disk with AxxonSoft's [SolidStore](#) file system.
- If necessary, allocate other system disks to archive storage.
- Click the **Apply** button.  
A dialog box is displayed, warning about formatting of the relevant system disks.

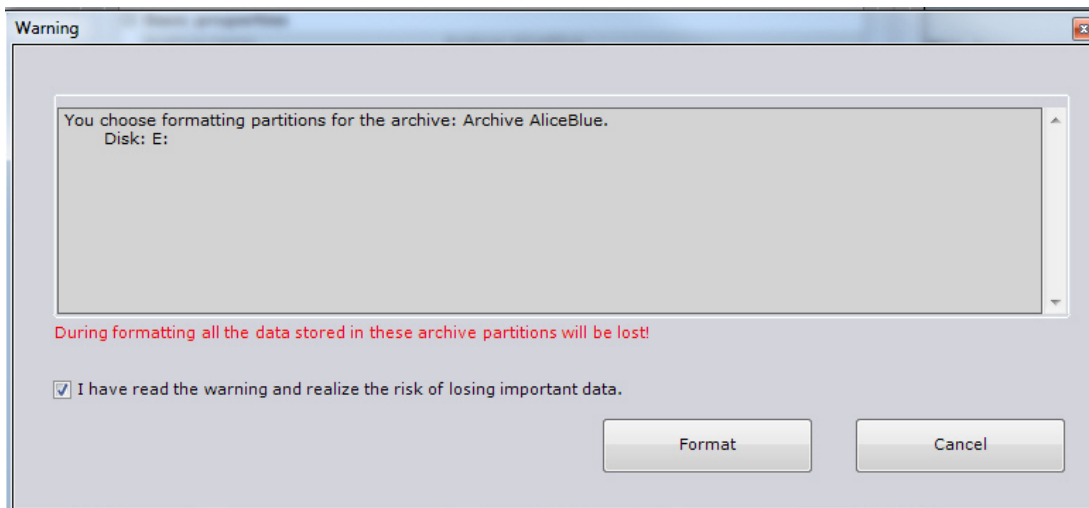

9. Read through the list of partitions that will be formatted. If the list is correct, select I **have read the warning and realize the risk of losing important data**, then click **Format**. Otherwise, click **Cancel** to return to the archive settings.

Creation of an archive with the desired parameters is now complete.

The archive size relative to the total amount of space on system disks is displayed in the **Allocation of archives** chart.

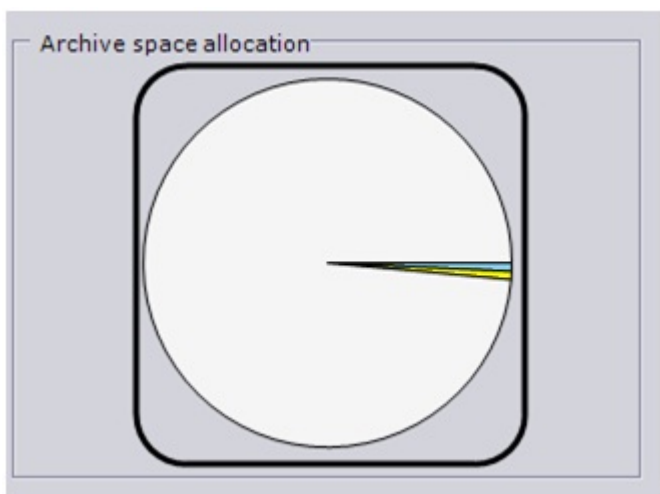

## Creating an archive based on an existing file or partition

When creating an archive from an existing file or partition, you can extract archived recordings only if the following conditions are met:

- The name of the computer on which the recording was written to the existing archive file is the same as the name of the current computer.
- The IDs of the video cameras from which the recordings were written to the existing archive file or partition are the same as the IDs of the current video cameras.

To create an archive based on an existing file:

1. Create an archive.
2. Select the disk on which the archive file was located.

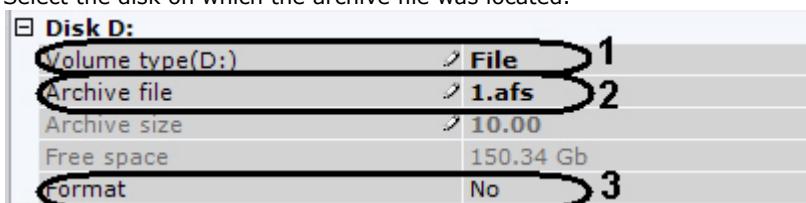

3. In the **Volume type** list, select **File (1)**.
4. Select the archive file to which the recordings were written (**2**).
5. In the **Format** list, select **No (3)**.

**Note**  
If you select **Yes**, all archive recordings in the file will be erased. You will be asked if you want to change the size of the archive file

- Click the **Apply** button.

The archive is created and, if all requirements are met, the archive recordings are available.

To create an archive based on a previously used partition:

- Create an archive.
- Select the disk on which the archive was located.

Disk E:	
Volume type(E:)	Partition 1
Archive file	E:
Archive size	0.00
Free space	24.41 Gb
Format	No 2

- In the **Volume type** list, select **Partition (1)**.
- In the **Format** list, select **No (2)**.

**Note**  
If you select **Yes**, all archive recordings will be erased.

- Click the **Apply** button.

The archive is created and, if all requirements are met, the archive recordings are available.

## Configuring Recording of the Video Stream from Video Cameras to the Archive

To configure recording of the video stream from video cameras to the archive, you must perform the following steps:

- Left-click the icon in the **Linked archive(s)** table (1) at the intersection of the row corresponding to the camera from which the video stream should be recorded to an archive and the column corresponding to that archive.

**Note**  
Archives are marked with  badges of the corresponding colors (see the section [Creating archives](#))

**Note**  
Parameters for the video stream that is recorded to disk from the camera are shown in the **Video parameters for recording to archive** group (2)

- In the **Mode** list (3), select the desired mode of recording the video stream from the video camera to the archive. The table lists all cases when video is written to the archive, in the absence of other circumstances.

Recording mode	Description
No recording	The video stream is not recorded to archive
Continuous recording	The video stream is recorded to archive continuously
Scheduled recording	The video stream is recorded to archive according to specific schedules or when an alarm is manually initiated
Recording on demand	The video stream is recorded to archive when detection units are triggered or when an alarm is manually initiated

**Note**  
If a video camera is linked to multiple archives, after an alarm is manually initiated video is always recorded to the default archive

- If scheduled recording has been chosen, in the corresponding drop-down list (3), select the schedule (see the section [Configuring schedules](#)) according to which recordings will be written to the archive.
- If you need to record to archive using scaling, select **Yes** in the drop-down list (3).

**Attention!**  
When a video stream with inter-frame compression (MPEG4 and H.264) is downsampled, only the key frames are preserved. This can cause a large decrease in the frame rate in recorded video (to 2 - 3 fps). If this occurs, we advise you to use such codecs as MJPEG and Motion Wavelet.

- If you choose recording with scaling, enter the maximum frame rate when recording the video stream from a video camera to the archive in the **Max frame rate** field (3). If the frame rate of the video stream coming in from a video camera is less than the indicated value, the recording will be made at the original and not the maximum rate.
- The default archive of a video camera is the archive to which images from a given video camera are recorded during user-initiated alarms. For each video camera one and only one default archive must be set. The first archive to which recording of a video stream from a video camera was configured automatically becomes the default archive.  
If you need to make another archive the default one for this video camera, select **Yes** in the **Default archive** list for that other archive (3).
- In the **Pre-alarm recording time** field (3), enter the buffering time of the video stream from the camera in seconds. This value should be in the range [0, 120].

**Note**  
Pre-alarm recording is the period of pre-event recording that will be added to the beginning of an alarm event recording

- Repeat steps 1-6 to configure recording of the video stream from a camera to all desired archives.

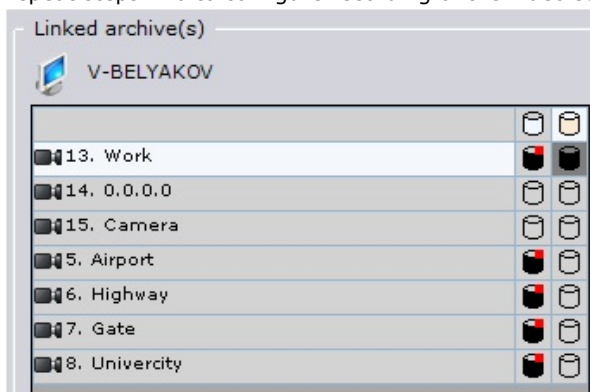

- Click the **Apply** button.

Configuration of recording of the video stream from a camera to archives is complete.

**Note**  
The archive's icon in the **linked archive(s)** table automatically changes based on the recording settings.

	No recording	Record with specified fps: Yes	Record with specified fps: No
<b>Default archive: None</b>			

Default archive: Yes

-



[Play corresponding video](#)

## Viewing Archive Fullness

When you select an archive in the list, its basic properties show the following information:

1. Predicted archive capacity, measured in days and minutes (**Depth** field).
2. The percentage of the archive that is full (the **Recorded archive volume** field).

Basic properties	
Archive name	Archive AliceBlue
Color	<input type="checkbox"/> AliceBlue
Archive size	24.41 Gb
Depth	920 min
Recorded archive volume	100 %



### Note

The value of the predicted archive capacity is constantly calculated and recalculated. The longer you have been recording to the archive, the more precise this estimate will be. To refresh the predicted archive capacity, re-select the archive in the list

## Deleting Archives

You can delete an archive from the system.

To delete an archive from the system, you must perform the following steps:

1. Select the archive to be deleted in the archive list.
2. Right-click to bring up the context menu. Select the **Remove archive** command.

List of archives

Search...

- V-BELYAKOV
  - Archiv AliceBlue
  - Archiv AliceBlue
  - Archiv AliceBlue
  - + Create archive

Context menu options: Create archive, Remove archive

3. Click the **Apply** button.

During deletion of an archive that was stored at least partially as a file, you will be asked if you want to delete files that are related to the archive.

Attention!

Would you like to remove files associated with the archives being removed?

Yes No



### Attention!

If you delete the archive files, all archive recordings in the files will be lost.

If you do not delete the archive files, you can use them to re-create the archive (see [Creating an archive based on an existing file or partition](#)). You can also use a partition to re-create an archive

Deleting an archive from the system is now complete.

## Configuring layouts

Axxon Next allows users to configure custom layouts (see [Layouts ribbon modes](#)).

Separate layouts are configured for each user of the system. To configure layouts, log into the Server under the appropriate user name and configure the layouts for that user.

**Note**  
Creation, editing, copying, and deletion of layouts are available to users that belong to roles with the **Changing custom layouts** component activated (see [Creating and Configuring the Role and User System Objects](#)).

After you configure a user's layouts, you may want to limit that user's privileges.

[Play corresponding video](#)

## Layouts ribbon modes

Axxon Next has two types of layouts: standard and custom (see [Switching between layout types](#)).

The standard layouts are an automatically defined set of layouts. Standard layouts cannot be created, deleted, or edited. Each button on the layouts ribbon represents a group of layouts of the same type. The layouts in a group differ only in the video cameras contained within them. If a group of layouts contains more than one layout, then a context menu will become accessible for that group. The operator can use this context menu to select layouts in the group or to launch a cyclical slideshow of layouts in that group.

In standard layouts ribbon mode, the following modes are available: 1x, 4x, 9x, wide-frame, and others.

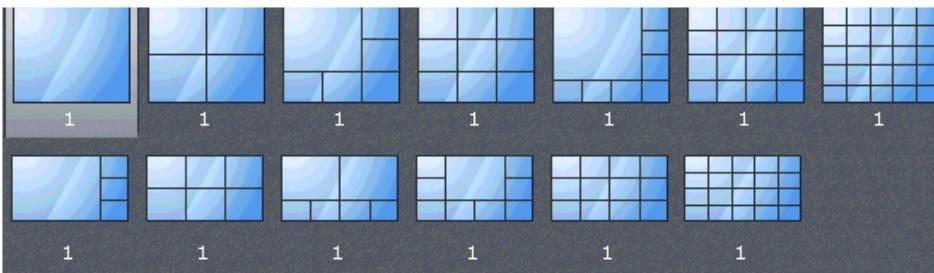

Custom layouts are layouts created manually based on standard layouts. Custom layouts can be created, edited, and deleted.

## Switching between layout types

When working with Axxon Next, the user can choose either a standard layout or a user-defined layout. To switch between these types of layouts, perform the following:

1. Go to **Settings Options User interface (1-2)**.

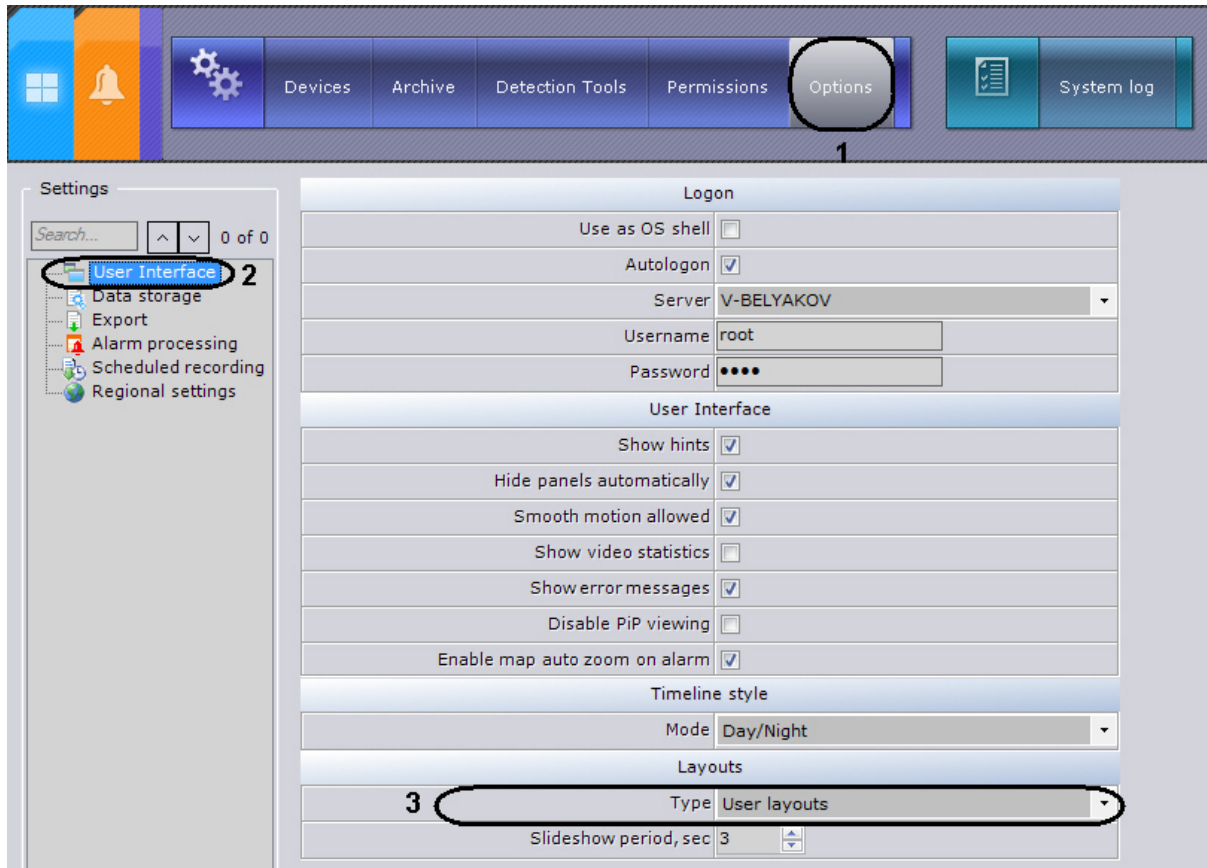

2. Select the layout type in the corresponding drop-down list (3).
3. Click the **Apply** button to save the settings.

The layout ribbon will then operate in the selected mode.

**Note** Switching layout modes is allowed only for users with **Layout configuration** permissions

## Creating and deleting layouts

Layouts are created based on standard layout types. To create a new layout, select one of the standard layouts in the context menu of the layouts ribbon. The newly created layout will be named automatically. The layout will then be placed at the beginning of the list in the layout ribbon.



**Note** A new layout is also created when a video camera that is not displayed in any previously created layout is selected on the video camera panel

If necessary, the name of the newly created layout can be changed. This can be done by left-clicking the mouse over the layout name and then editing the name. To save the name, type Enter or left-click anywhere on the screen (except for the line that contains the name).

To delete the selected layout, perform the following:

1. Select the layout on the layout ribbon.
2. Click the  button to bring up the context menu. The context menu of the layout ribbon will then be displayed.

### 3. Select **Delete layout**.

Deletion of the layout is now complete.

## Layout copying

You can copy existing layouts.

Select the layout that you want to copy. Click the  button to open the context menu and select **Duplicate layout**.

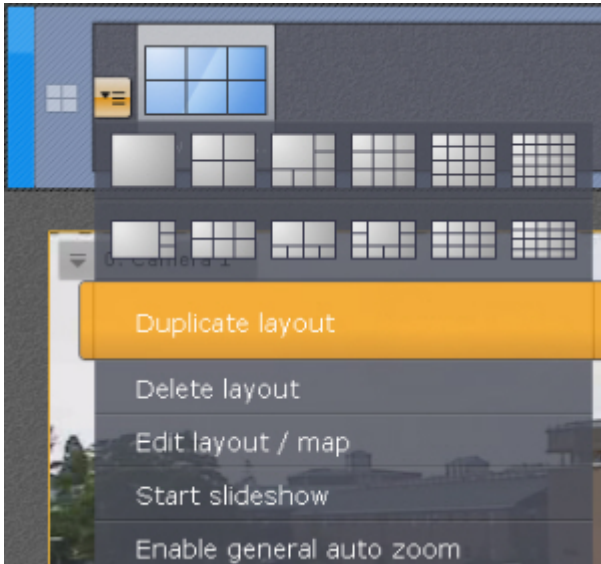

An identical layout is then created.

**Note**  
Layouts cannot be copied while in editing mode

## Editing layouts

Every layout consists of cells, which are viewing portals that can hold either video cameras or information boards.

**Attention!**  
Information boards in version 3.5.0 are available only for [pay & demo license](#) of Axxon Next. This functional will be available in [free versions](#) over 3.5.1.

Axxon Next offers three types of information boards that can be added to layouts:

1. Events Board
2. Health Board (for servers and cameras)
3. Statistics Board

Information boards are available on the layouts ribbon in editing mode.

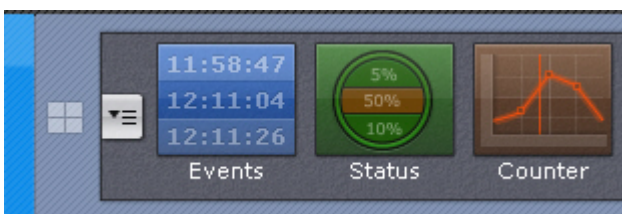

When a camera is added to a cell, a viewing tile appears.

## Switching to layout editing mode

To edit layouts, go to the **Layouts** tab. To switch to editing mode, click the  button to open the context menu of the layouts ribbon. Select **Edit layout**.

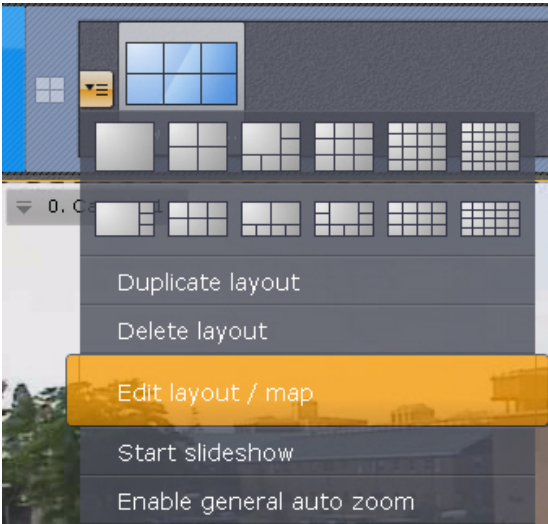

In layout editing mode, space is divided by a grid of equal-sized squares for holding viewing tiles (1).

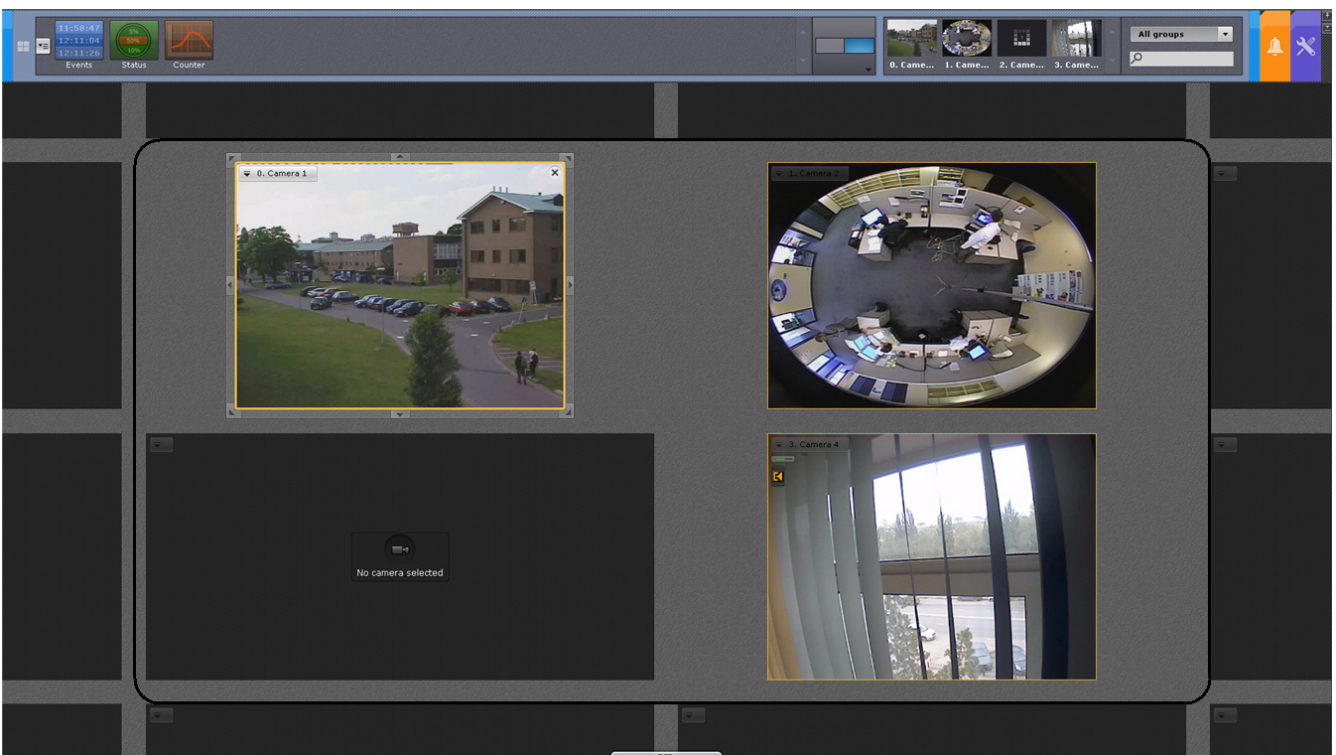

On the edge of the layout there are grid square fragments (2), which are parts of ordinary empty cells and allow adding new cells to the layout (see [Adding new cells to a layout](#)).

## Selecting a layout for editing

If your current license allows creating information boards, selection of a layout for editing is performed in the layouts ribbon, before switching to layout editing mode.

The sequence of actions is as follows:

1. Switch to the layout that you want to change (see [Select the displayed layout](#))
2. Switch to layout editing mode (see [Switching to layout editing mode](#))

Otherwise, select a layout for editing in the layouts ribbon. You can also use layout editing mode to create a new layout (see [Creating and deleting layouts](#)) for editing.

## Configuring layout cells

### Adding new cells to a layout

You can add new cells to a layout in one of three ways:

1. Drag a non-empty cell onto a grid square fragment (see [Moving cells](#)).
2. Left-click a grid square fragment and resize it (see [Resizing cells](#)).
3. Left-click a grid square fragment and select a video camera or information board in it (see [Adding cameras to cells](#)).

Cells are added in rows. For example, when editing a six-square (3\*2) layout, a column of two grid squares is added when a fragment is chosen on the left or right side of the screen.

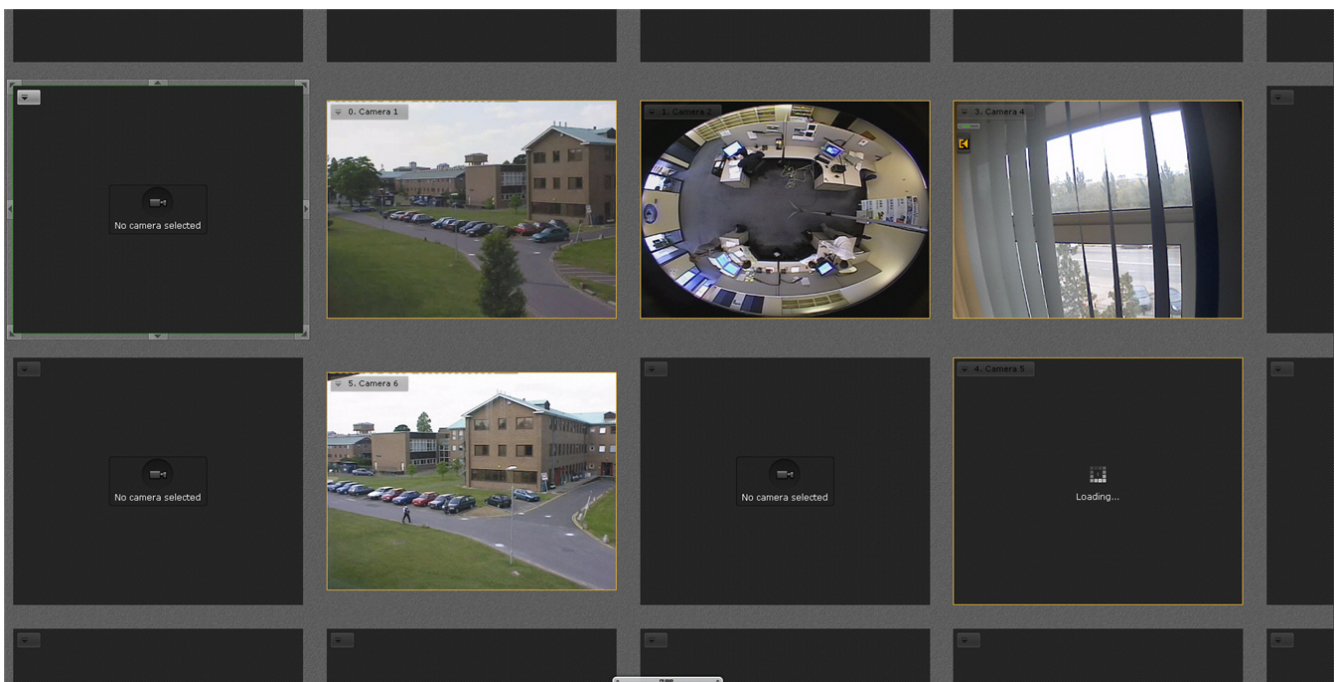
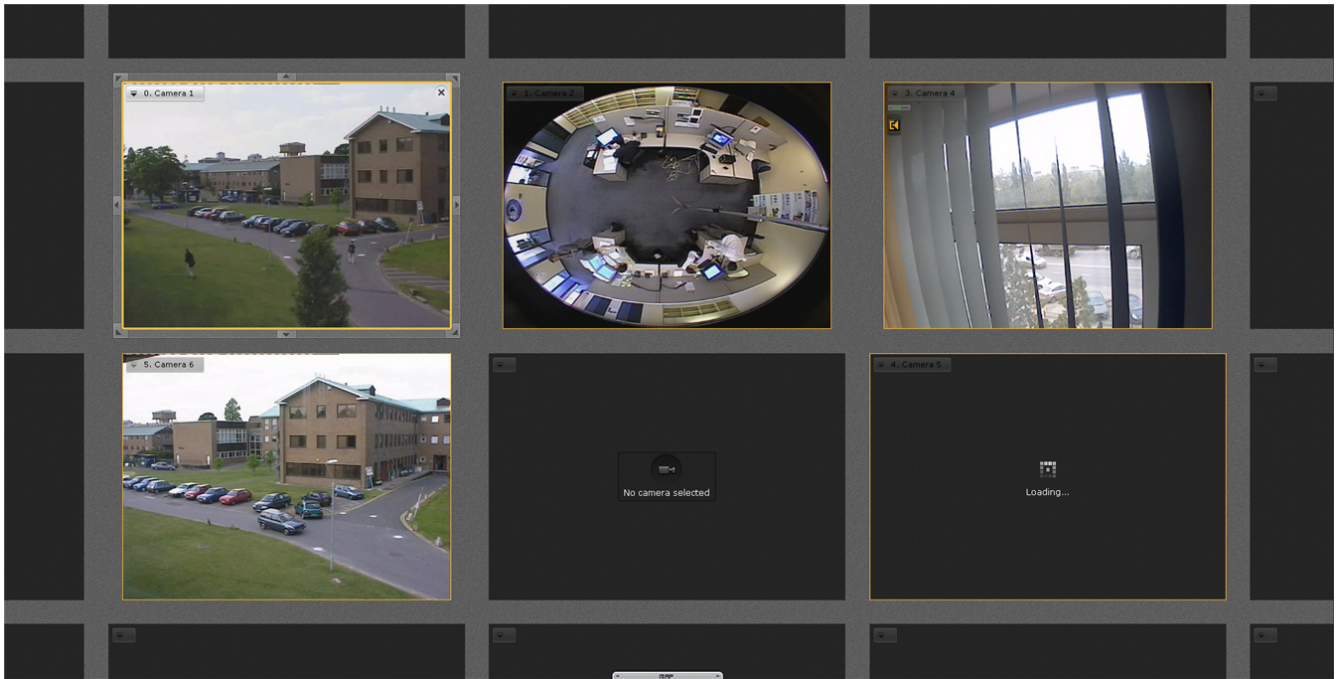

A row of three squares is added when you select a fragment from the upper or lower part of the screen.

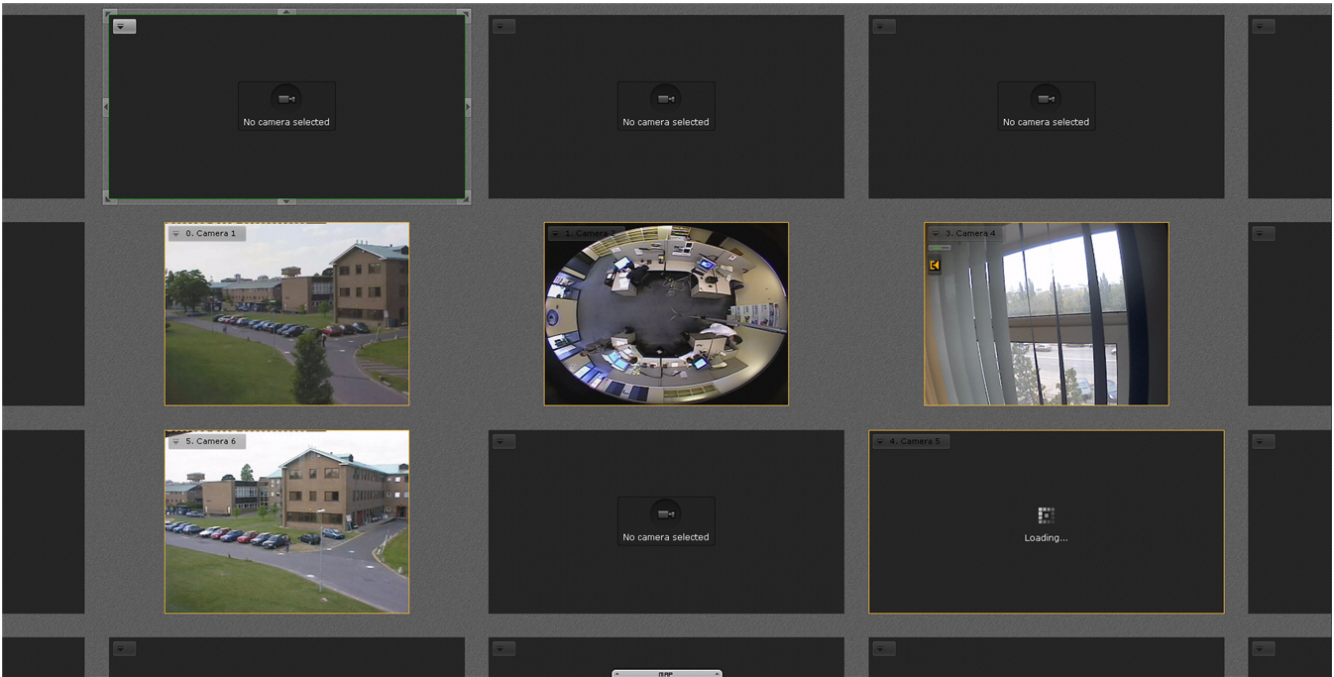

When you select a corner fragment, both a row and column are added.

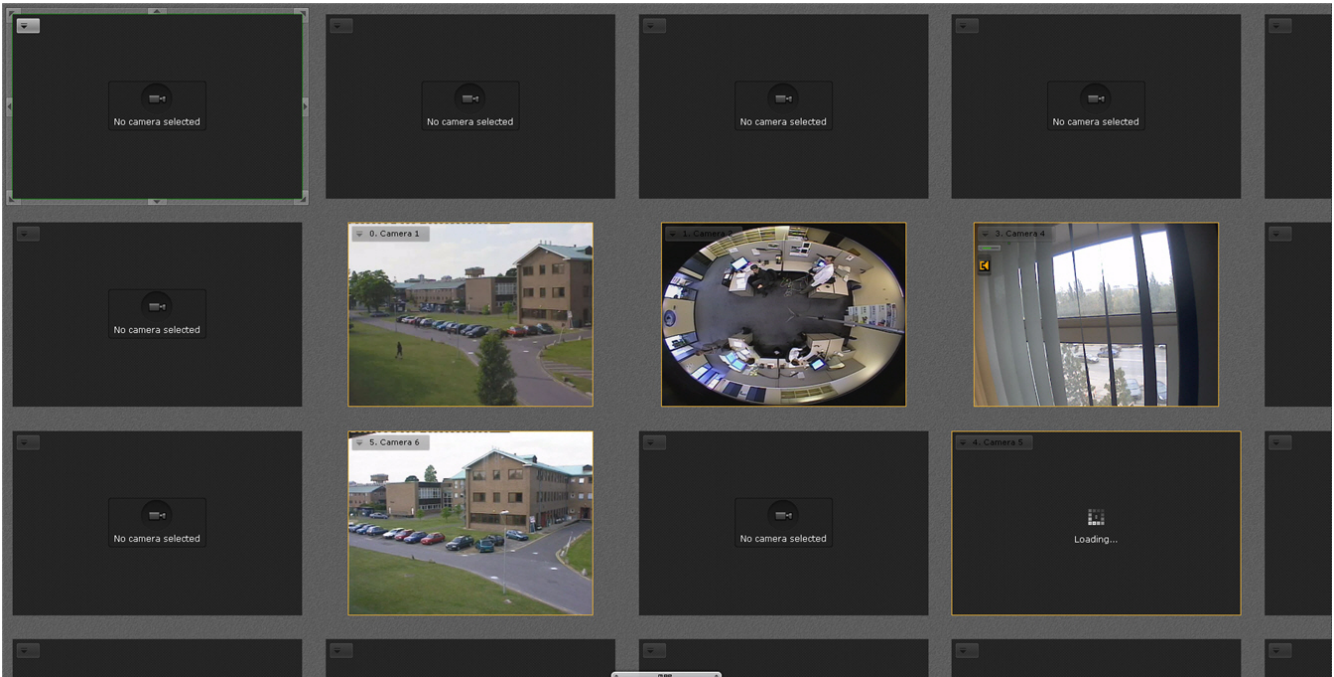

## Resizing cells

To resize a cell, use the buttons on its edges.

Button	Action	Button	Action
	Increases the cell by a column to the left and row above		Increases the cell by a column to the right and row below
	Increases the cell by a column to the left		Increases the cell by a column to the right
	Increases the cell by a column to the left and row below		Increases the cell by a column to the right and row above
	Increases the cell by a row below		Increases the cell by a row above

When you point the cursor at any button, a darkened area that shows the size of the cell after resizing is displayed.

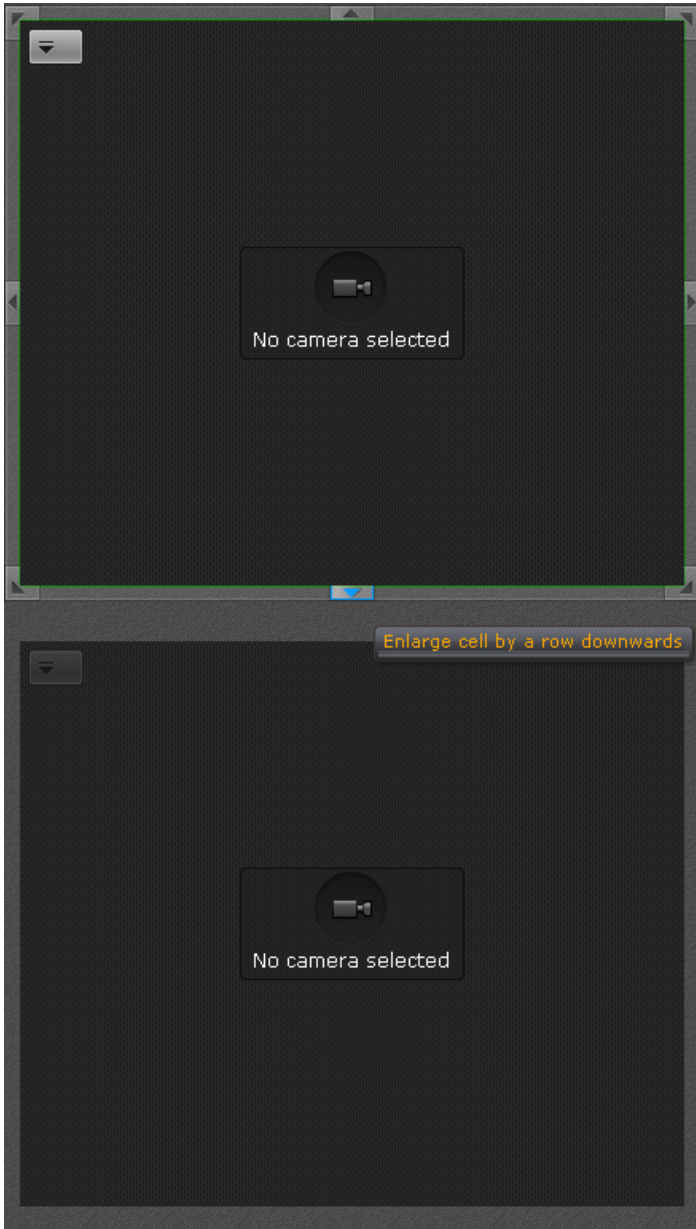

## Moving cells

To move a cell, left-click the frame of the grid square fragment and drag it to the necessary position.

The cells are then switched: the contents of the previously occupied cell are moved to the location of the cell being moved.

If a cell is moved to a grid square fragment, new cells are added to the layout (see [Adding new cells to a layout](#)).

## Adding cameras to cells

### On page:

- [Selecting a Video Camera Using the Cell Context Menu](#)
- [Selecting a Video Camera Using the Video Camera panel](#)

To add a camera to a cell, select one of the two available methods:

1. By using the cell context menu.
2. By using the video camera panel

You can add a camera to an empty cell or to a cell that contains an information board or other camera.

### **Selecting a Video Camera Using the Cell Context Menu**

To add a video camera by using the cell context menu:

1. Display the context menu (**1**).
2. Choose **Camera selection (2)**.

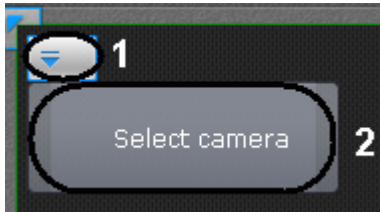

3. Select the necessary video camera in the displayed list using one of the following methods:
  - a. If the necessary video camera is included in a group, you must first select the group (the group may also contain subgroups), then select the video camera.
  - b. If the necessary video camera is not included in one of the groups, you must select the list of all video cameras that follows the list of groups.

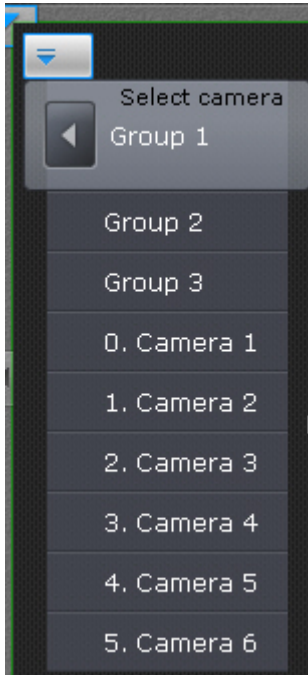

A video camera is then added to the cell and a viewing tile appears.

#### **Selecting a Video Camera Using the Video Camera panel**

To add a camera to a cell, perform one of the following actions:

1. Activate the viewing tile (by clicking it) and select the video camera from the list on the video camera panel (see [Video camera panel](#)).
2. In the list on the video camera panel, click a video camera to select it. Drag the camera to a cell and then release the mouse.

A camera is then added to the cell and a viewing tile appears.

### **Adding information boards to cells**

You can add information boards to cells in two ways:

1. Activate the cell (by clicking it) and select the information board that you want to add to the cell.
2. Click an information board to select it. Drag the information board to the layout cell and then release the mouse.

You can add an information board to an empty cell or to a cell that contains a camera or other information board.

### **Clearing cells**

To remove an information board or camera from a cell, in the upper-right corner, click the  button.

If clearing cells in a row or column removes content from all of these cells, the entire row and/or column is removed from the layout.

## **Configuring viewing tiles**

### **Selecting default functions for viewing tiles**

Default values for video stream quality, object tracking, autozoom, and video display (visualization) functions can be set for viewing tiles.

After the user switches to a layout, these functions are activated automatically.

To set a function as a default one, activate it during layout editing mode (see [Selecting video stream quality in a viewing](#)

tile, [Tracking objects](#), [Autozoom](#), [Video image processing](#)) and save changes before exiting the mode.

### Selecting the default video mode for a camera

By default, when you switch to a layout, all video cameras are in real-time / live viewing mode.

You can select a default video mode for each camera: real-time mode or archive mode.

#### Note

This function is not available if the camera is not attached to an archive.

To select a default video mode, in the context menu of the viewing tile, select **Viewing mode** and select the necessary mode.

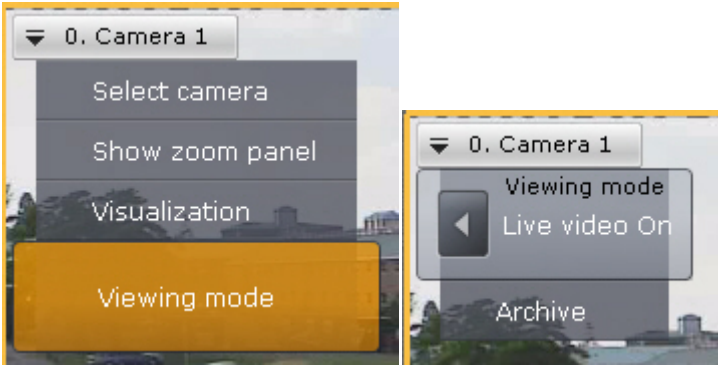

If archive mode is selected, when you switch to the layout, the camera is immediately in archive mode.

### Moving sensor and relay icons in a viewing tile

You can move sensor and relay icons in a viewing tile.

To do so, left-click the sensor or relay icon and drag it to the place in the viewing tile where you want to put the icon.

### Configuring default zoom levels (the Fit screen function)

The Fit screen function allows displaying a viewing tile by default so that it occupies all of the available space on the screen (full screen). The default zoom level for full screen display is calculated automatically as a minimum zoom value that allows filling the available screen space with the viewing tile contents.

To enable the Fit screen function, display the digital zoom controller (see [Digitally Zooming Video Images](#)), click the  button on it, and save changes when exiting editing mode.

#### Note

To disable the Fit screen function, click the  button again.

Now when a user switches to this layout, the video in the viewing tile is displayed at the calculated minimum necessary level of digital zoom and the viewing tile occupies all available space.

If motion is detected in an off-screen area, the zoom level is automatically adjusted in order to display the area with movement. If motion stops or the object moves out of the camera's FoV, the previous digital zoom settings are restored.

### Configuring pan/tilt angle for video cameras with Immervision lenses in 180 Panorama display format

You can set the pan/tilt angle for fisheye cameras in 180 Panorama display format when switching to a layout.

This is useful when needing to display the entire viewable area in the layout (two areas of 180 each). In this case, the video camera is added twice but with different viewing angles.

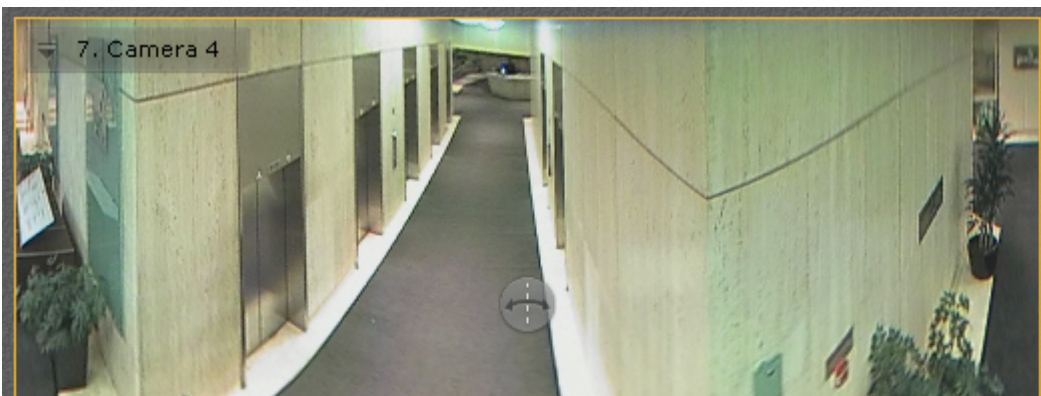

To set the viewing angle, click and hold the  button (see 180 degree Panorama).

## Configuring information boards



### Attention!

Information boards in version 3.5.0 are available only for pay & demo license of Axxon Next. This functional will be available in free versions over 3.5.1.

## Linking information boards and viewing tiles

You can link information boards with viewing tiles.

Links are set by placing items in neighboring cells. A single information board can be linked with multiple cameras. Boards cannot be linked with each other, nor can viewing tiles be linked with each other.

Linking information boards to viewing tiles, in addition to graphical changes (shared background), results in other changes:

1. The size of the linked viewing tiles is increased/decreased in a different way (see [Scaling the Viewing Tile](#)).
2. You can view recorded video for a camera by clicking an event on the Events Board (see [Switching a camera linked to an Events Board to the archives](#)).

To create a link, select an information board or a viewing tile that neighbors at least one cell containing an information

board. Click the  button on the edge of the cell.

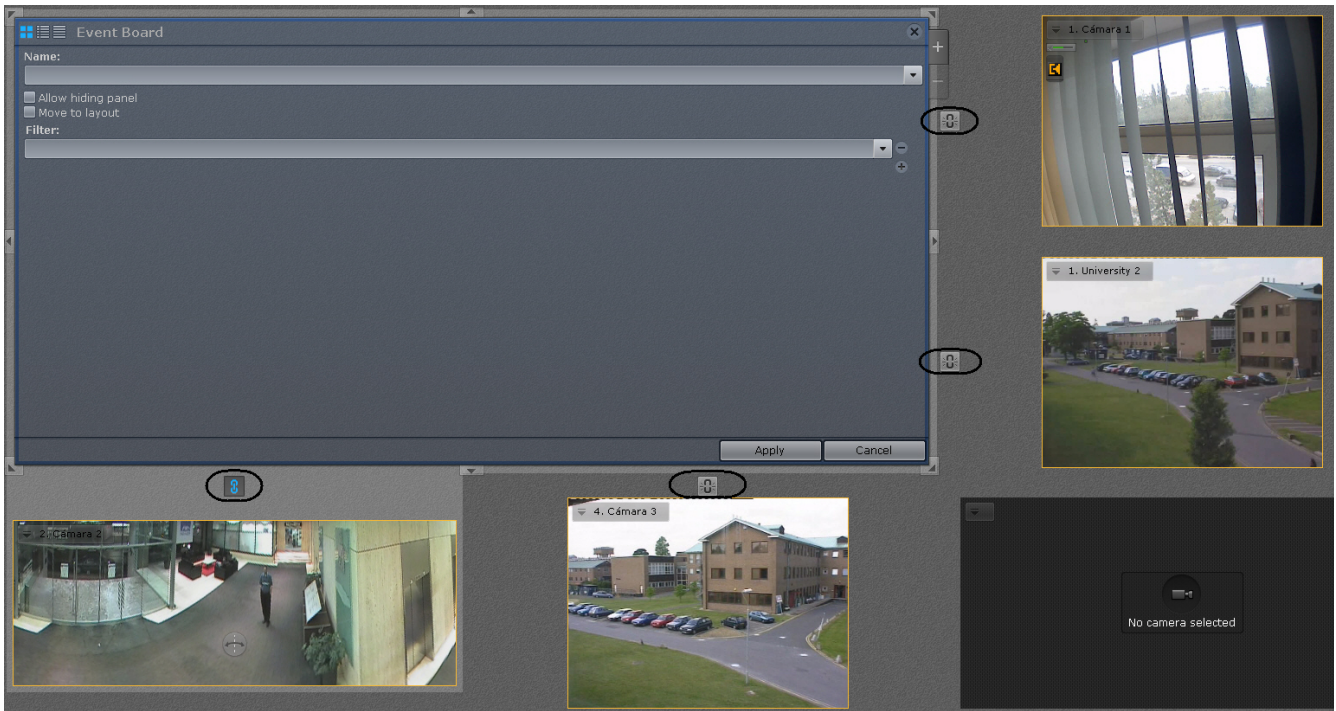

To remove a link, on the edge of the linked cells, click the  button.

## Configuring information board templates

To save information board parameters as a template, specify a name when configuring an information board.



If a name is not specified for the information board (it is not necessary to specify one), no template with the information board parameters is saved or made available when creating new information boards.

When configuring a new information board, you can use previous templates for the type of information board in question by selecting one from the **Name** list.

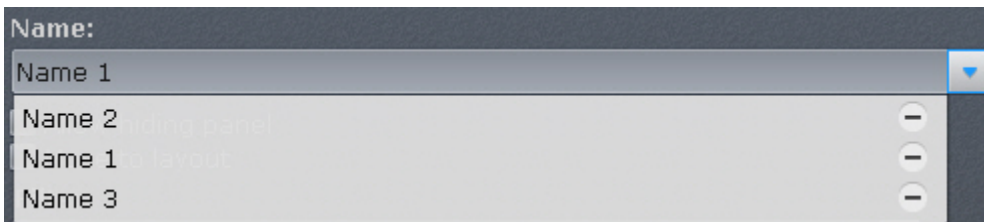

If you save the new information board with the same name, the template parameters are updated and all information boards based on the template are updated as well.

To delete a template, in the **Name** list, click the  button across from the template. The parameters of information boards based on the deleted template are saved, but their names are discarded.

## Configuring Events Boards

### Configuring Events Boards

Events Boards display some or all system events.

To configure an Events Board:

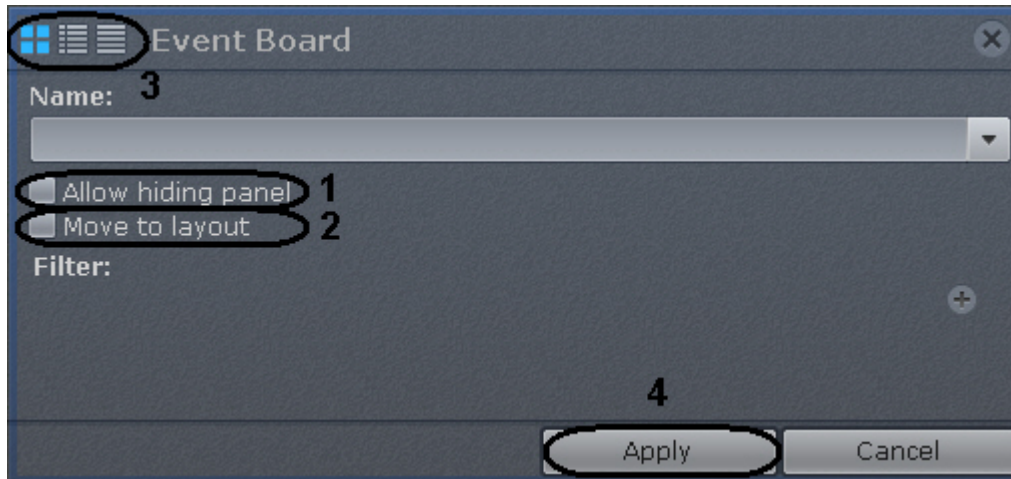

1. Add an information board to the layout (see [Adding information boards to cells](#)).
2. Click anywhere on the information board to enter configuration mode.

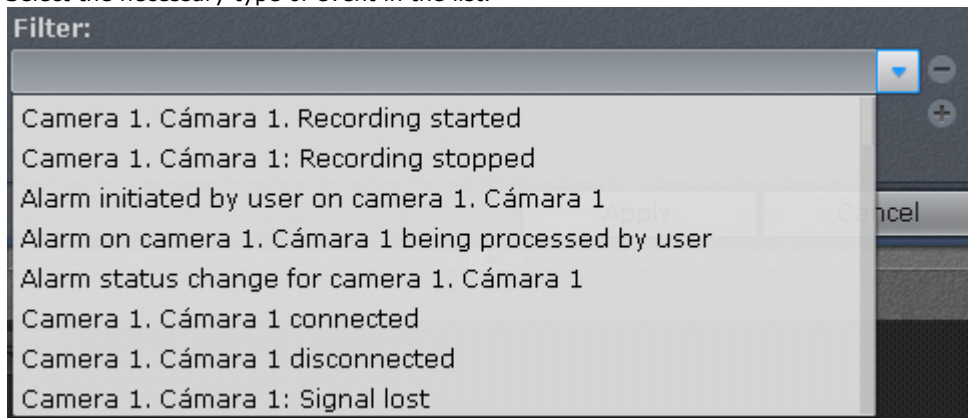

3. To allow operators to hide the information board, select the **Allow hiding panel** check box (1).
4. To automatically open the layout with this information board when an event matching the filter occurs, select the **Switch to layout** check box (2) (see paragraph 5).  
If other layouts contain information boards with the same parameters, the layout with the smallest number of cells is opened. If there are multiple layouts with identical numbers of cells, the layout that comes first in the alphabet is chosen. If a layout containing this information board is open when an event is received, no switch to another layout is performed.
5. Select the event types that you want to display on the information board:
  - a. Click the  button to add a new event type.
  - b. Select the necessary type of event in the list.



- c. Repeat the first two steps to add all necessary event types.

 **Note**  
To remove an added event type, click the  button

- If no event type is selected, all system events are displayed on the information board.
6. Select the default view for information on the Events Board (see [Options for displaying information on Events Boards](#)): the first frame of the event and time, first frame and text, or text only (3).
  7. Click the **Apply** button to save changes (4).

Configuration of the Events Board is complete.

## Configuring a Health Board

Health Boards display the status of selected system servers and connected cameras.

To configure a Health Board:

1. Add an information board to the layout (see [Adding information boards to cells](#)).
2. Click anywhere on the information board to enter configuration mode.

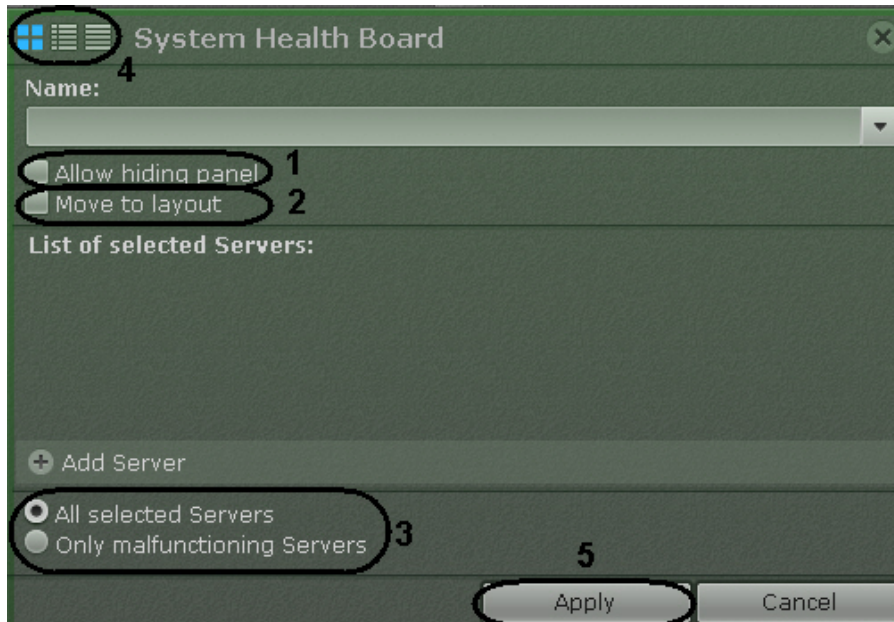

3. To allow operators to hide the information board, select the **Allow hiding panel** check box (1).
4. To automatically open the layout with this information board when the status of a monitored server or camera changes, select the **Switch to layout** check box (2) (see paragraphs 5 and 6).  
If other layouts contain information boards with the same parameters, the layout with the smallest number of cells is opened. If there are multiple layouts with identical numbers of cells, the layout that comes first in the alphabet is chosen. If a layout containing this information board is open when an event is received, no switch to another layout is performed.
5. Click the **+ Add Server** button and select the servers whose status you want to monitor.

**Note**

To remove the selected server, click the  button

6. To display the status of only distressed servers out of those selected, select **Distressed Servers only** (3).  
A server is classified as distressed if any of the following are true:
  - a. Any component (CPU, hard disk, or network connection) is in critical condition.
  - b. There is no connection to the Server.
  - c. Any video cameras of the Server are in critical condition.

**Note**

Information about the status of Servers and cameras is given in the section [Working with Health Boards](#).

7. Select the default view for display of information on the Health Board (see [Working with Health Boards](#)): diagram, diagram with text, or table (4).
8. Click the **Apply** button to save changes (5).

Configuration of the Health Board is complete.

## Configuring a Statistics Board

Statistics Boards display information on the number of events of the selected type or types, as a number and graph.

To configure a Statistics Board:

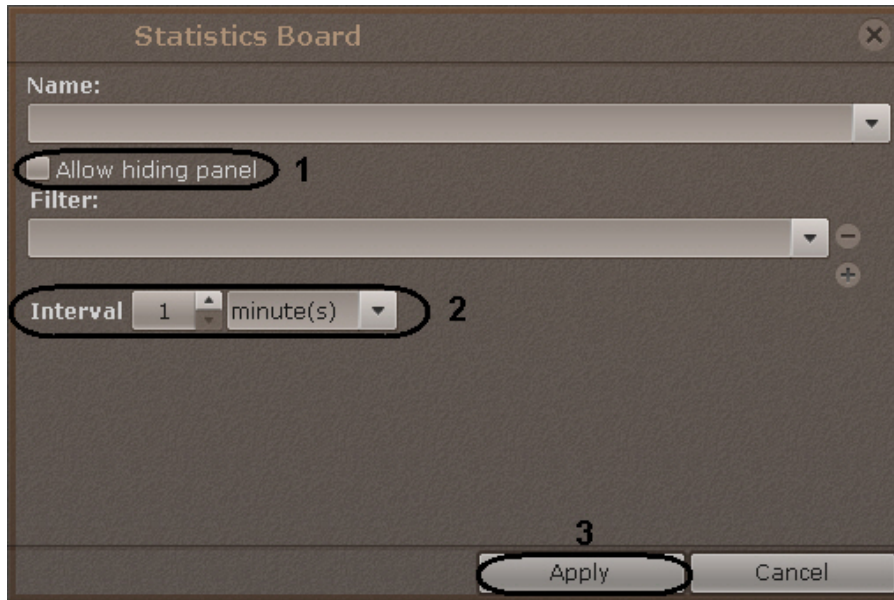

1. Add an information board to the layout (see [Adding information boards to cells](#)).
2. Click anywhere on the information board to enter configuration mode.

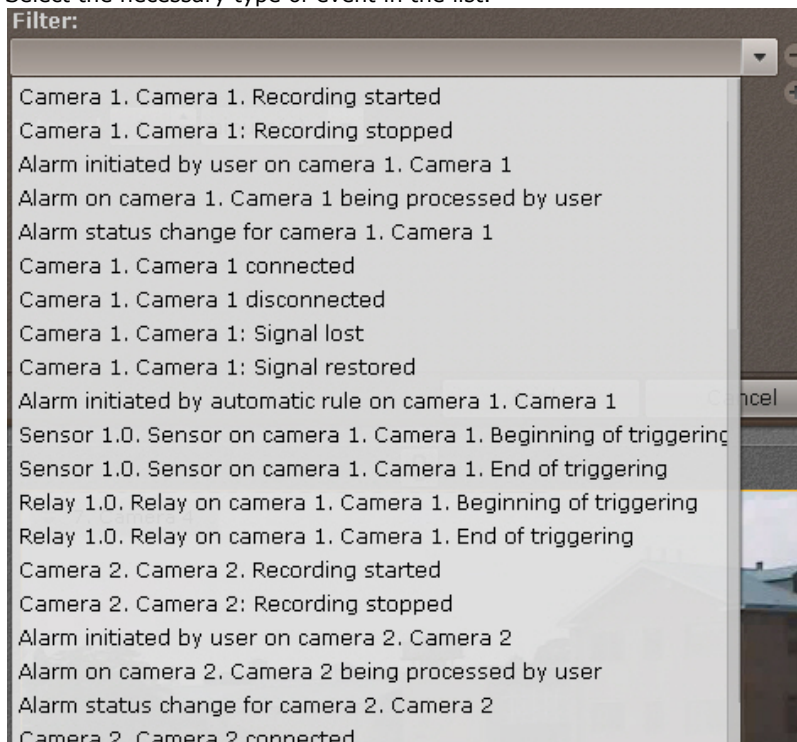

3. To allow operators to hide the information board from a layout, select the **Allow hiding panel** check box (1).
4. Select the event types that you want to be counted:
  - a. Click the  button to add a new event type.
  - b. Select the necessary type of event in the list.



- c. Repeat the first two steps to add all necessary event types.

 **Note**  
To remove an added event type, click the  button.

- If no event type is selected, all system events are counted.
5. Select the time period for display of statistics on the graph (2).
  6. Click **Apply** to save the changes (3).

Configuration of the Statistics Board is complete.

## Exiting layout editing mode

To exit layout editing mode and save changes, click the  button to open the context menu of the layouts ribbon and select **Save changes** (1).

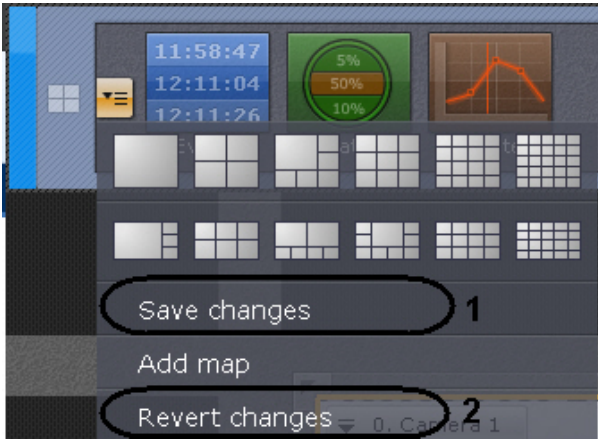

To exit editing mode without saving changes, select **Revert changes** (2).

## Configuring the Interactive Map

Configuration of the interactive map is performed in layout editing mode (see the sections [Interactive Map](#), [Switching to layout editing mode](#)).



**Note** Layout editing mode and the interactive map are not available if the standard layouts are displayed on the layouts ribbon (see the section [Switching between layout types](#)).

**Note** Creation, editing, and deletion of interactive maps are available to users with roles for which the **Change maps** component is activated (see the section [Creating and Configuring the Role and User System Objects](#)).

## Creating a new map

To create a new map, complete the following steps:

1. Do one of the following four actions:

- a. In the lower-left part of the screen, click the  button (after displaying the map, see [Opening and closing the map](#)).
- b. Click the  button to open the context menu of the layouts ribbon and select **Add map**.

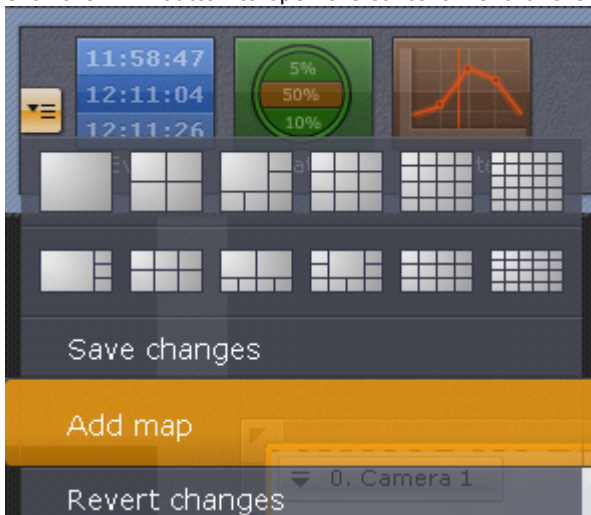

- c. In the map context menu (right-click the empty background), select **Add new map**



- d. Select a video camera from the list on the video camera panel by clicking it and, while holding down the mouse button, move the cursor to the empty map background and then release the mouse button.



**Note**

Actions **c** and **d** are available if no maps have been created in the system

2. Enter the map's name (**1**).

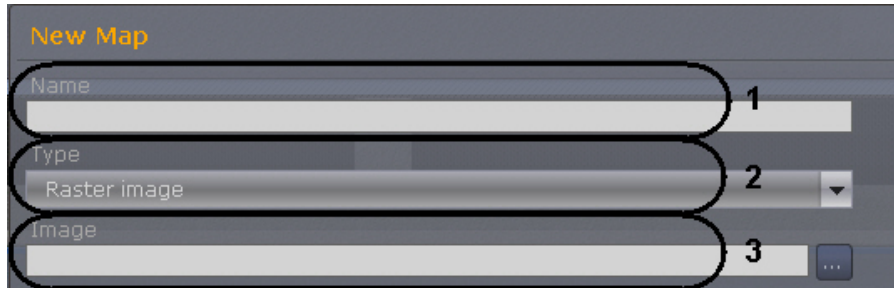

Select what will be used as a map: an image or geodata from OpenStreetMap (**2**). If you select a map from OpenStreetMap, select the appearance to use: map type (**OpenStreetMap** option), **Satellite**, or **Hybrid**.

**Attention!**

Geodata of OpenStreetMap provider in version 3.5.0 are available only for [pay & demo license](#) of Axxon Next. This functional will be available in [free versions](#) over 3.5.1.

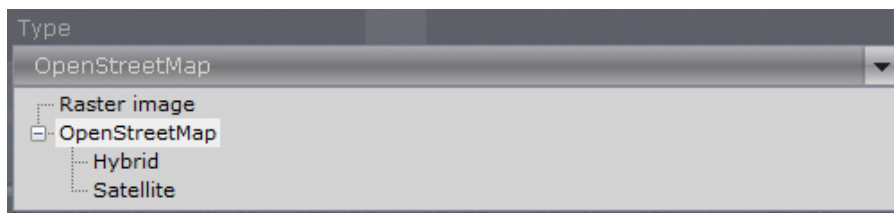
**Note**

The maximum image size is 4 million pixels (the number of pixels at 2000x2000 resolution). If a larger image is selected, no map is created

3. In the corresponding field (**3**), select the image that will be used as the graphical blueprint of the site (if the **Raster image** map type is selected) or find the site in OpenStreetMap by address, postal code, or geographical coordinates (enter the information in the **Address** field; detailed information about search is given on the [provider's website](#)). Scale can be adjusted by the scaler control or mouse wheel. You can navigate around the map using standard methods.

**Note**

If the **Raster image** map type is selected, it is not necessary to select an image. In this case, a map with a white background is created.

4. Click **Apply** (**3**).

You have created a new map.

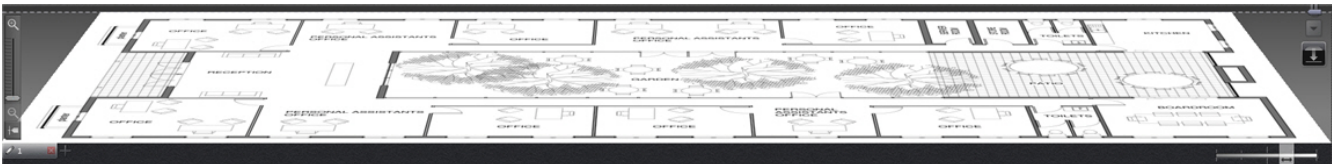

## Adding system objects to the map

On maps you can add three types of system objects (video camera, relay, and sensor) as well as objects for switching to another map.

### Adding video cameras

You can add cameras to the map in one of three ways:

1. By using the viewing tile context menu.
2. By using the map context menu.
3. By dragging a video camera icon from the video camera panel to the map.

To add a camera to the map, in the context menu of the viewing tile, select **Add to map**.

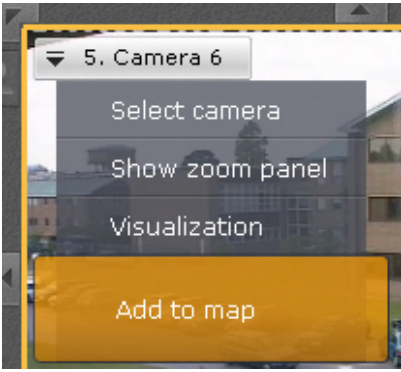

The camera is added to the map.

To add a video camera by using the map context menu:

1. Right-click to open the map context menu and select **Add video camera**.

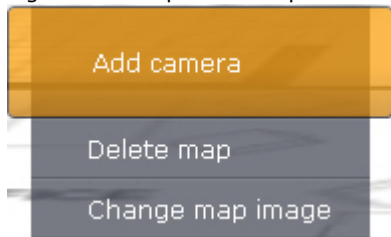

2. Select the necessary video camera in the displayed list by using one of the following methods:
  - a. If the necessary video camera is included in a group, you must first select the group (the group may also contain subgroups), then select the video camera.
  - b. If the necessary video camera is not included in one of the groups, you must select the list of all video cameras that follows the list of groups.

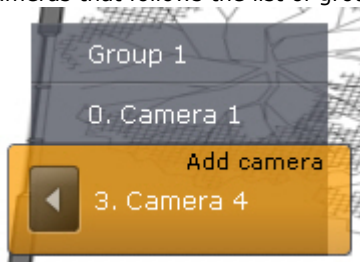

The camera is added to the map.

You can also, in the video camera panel, left-click a video camera's icon. Drag it to the map.

## Adding sensors and relays

To add sensors and relays to the map:

**Note**  
Only **Sensor** and **Relay** objects that have been activated can be added to the map.

1. Right-click the icon of the video camera on the map. A context menu appears.
2. To add a sensor, select **Add sensor (1)**. To add a relay, select **Add relay (2)**.

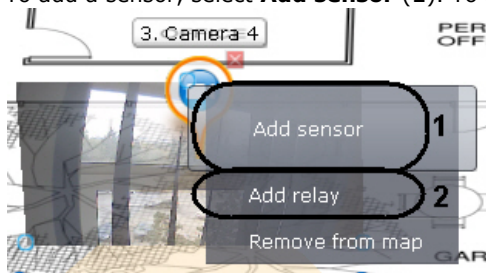

3. In the list, select a **Sensor** or **Relay** object.

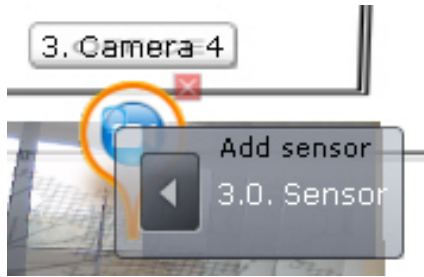

Sensors and relays have now been added.

By default, the icons of the sensor and relay are attached to the video camera's icon. If you move the video camera icon, the icons of all of the video camera's devices are moved as well.

However, you can detach the sensor and relay icons from the icon of the video camera. To do so, move them. Then the sensor and relay icons are moved independently.

## Adding switches to another map

You can add a "switch" to another map in one of two ways:

1. Select the tab of the map to which you want the switch to point and, without releasing the mouse button, drag it to the map and release the mouse button.
2. By using the map context menu.
  - a. Select **Add transition to map**.

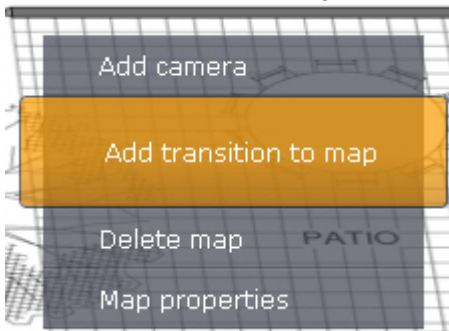

- b. Select the map in the system to which the new switch will point.

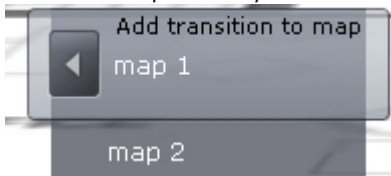

Addition of the switch is now complete



Then drag the switch icon to the necessary place on the map.

## Configuring cameras on the map

### Configuring a camera in standard map viewing mode

After adding a camera to the map, perform the following actions:

1. Drag the video camera's icon to the place on the map that represents the camera's actual location at the site (1).

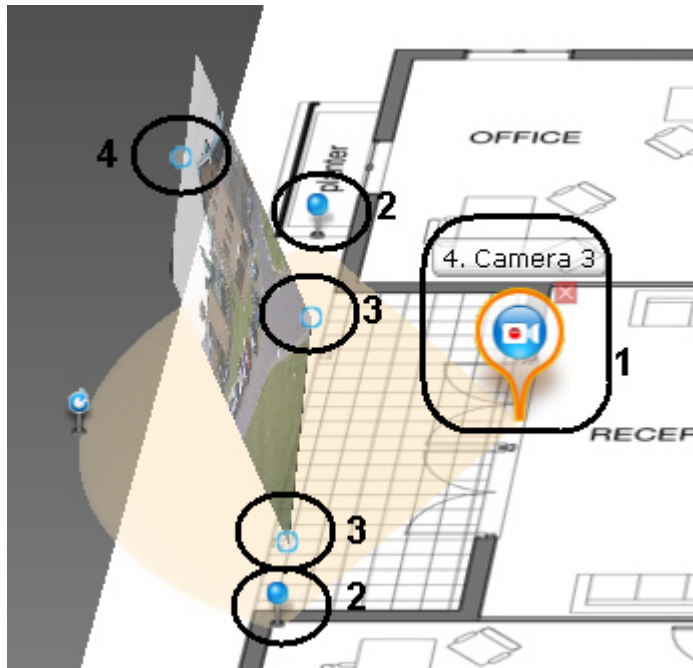

2. On the map, use the corner nodes to adjust the video camera's field of view to match the actual situation at the site (2).

**Important!**

For ceiling-mounted fisheye cameras (see [Configuring fisheye cameras](#)), you are advised to set a 360° field of view. If you do so, the video from the camera will be directly available in the specified area:



To enable this feature on cameras with ImmerVision lenses, **PTZ** display mode must be chosen (see [Configuring fisheye cameras](#))

3. Configure the area for video display:

**Important!**

The video display area is not available for ceiling-mounted fisheye cameras

- using the points at the base (3), set the size of the area (left-click and drag the cursor)
- using a third point (4) to change the tilt of the area
- using the slider in the lower-right corner to set the default transparency of the area



Configuration of the camera in standard map viewing mode is complete.

## Configuring cameras in immersion mode

You can link video to the objects shown on a map. This allows making video surveillance more visual and informative.

The feature is available through immersion mode (see [Immersive mode](#)).

To link video to a map, use the four attachment points. Objects in the video need to be linked to their depiction on the site map.

To link objects with symbols on the map:

1. Click an object in the video. A point is added.
2. Click on the depiction of the object on the map. A second point is added, connected by a line to the first point.



### Important!

When a fourth link is made, it is possible that the second point cannot be placed in some areas. This occurs when the system cannot find a valid angle for displaying the video and map for the given links. Most likely, the links have been set incorrectly.

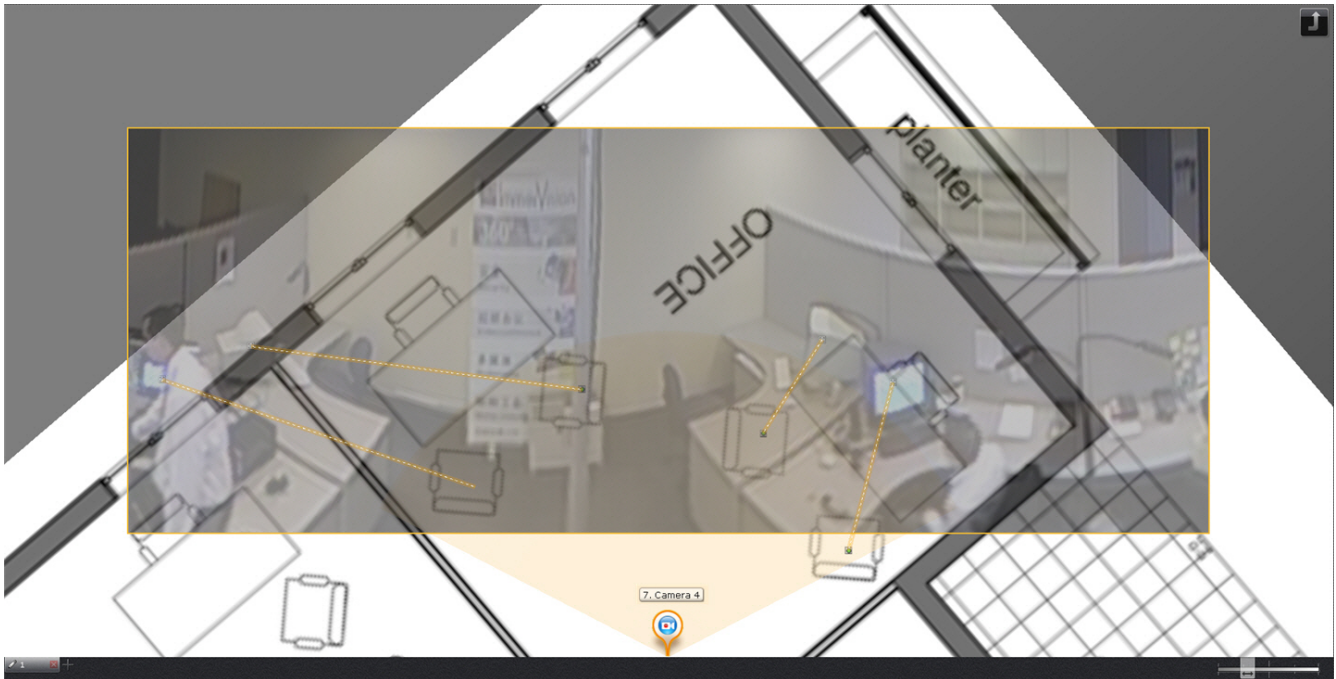

After a fourth link is added, an angle is chosen so that the surveillance objects in the video and on the map coincide.

To remove a link, place the cursor above the first point in the link and click the  button. After all links are added, it is possible to change the location of previously set points by dragging them while holding the left mouse button.

To save links between video and the map, exit layout editing mode and save changes. The links you make are discarded if any of the following occur before you exit and save changes:

- The position of the video camera icon on the map is changed.
- The angle of display of the video display area for the camera on the map is changed.
- The field of view of the camera on the map is changed in any way.

## Attaching a map to a layout

You can attach a map to a layout. This means that when you switch to the layout, the attached map opens automatically.

To attach a map to a layout:

1. Select the layout with which you want to associate the map in the layouts ribbon or create a new layout (see [Creating and deleting layouts](#) and [Selecting a layout for editing](#)).
2. Go to map editing mode (see the section [Opening and closing the map](#))
3. Go to an existing map with which you want to associate the layout or create a new map (see the sections [Switching between maps](#) and [Creating a new map](#)).
4. Save changes and exit layout editing mode (see [Exiting layout editing mode](#)).

After you save the layout, its icon resembles that shown in picture below.



If a map is open in 2D mode when you save a layout, when you switch to that layout, the map will always open in 2D mode. The layout icon resembles that shown in picture below.



The map is now attached to the layout.

## Removing objects from the map

To remove an object from the map, click the  button that is next to the object icon, or in the context menu, select **Remove from map**.

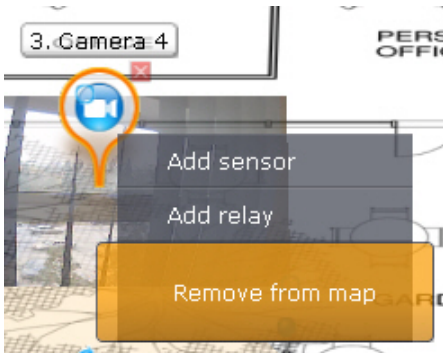

### Note

To delete a map switch, you must click the  button.

## Changing map type and display

You can change the type and display of a map that has been created previously. To do so, open the map context menu and select **Map properties**.

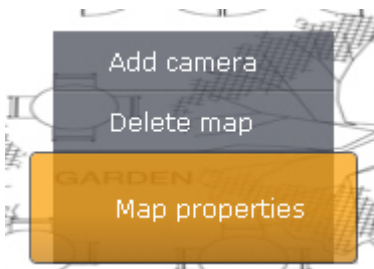

A map properties configuration window opens, which is similar to the map creation window (see [Creating a new map](#)).

## Renaming the map

To rename the map, in the lower-left corner of the screen, left-click a tab and specify a new name.

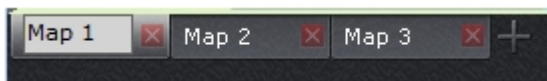

To save changes and exit editing mode, click the **Apply** button.

## Sorting of map lists

You can change the order of tabs for previously created maps. By default, tabs with maps are ordered by creation date.

To change the order, drag and drop tabs as necessary. Left-click a tab and drag it to the desired location.



## Deleting a map

To delete a map, in the lower-left corner of the screen, select the  button on the corresponding tab. Alternatively, in the context menu, you can select **Delete map**.



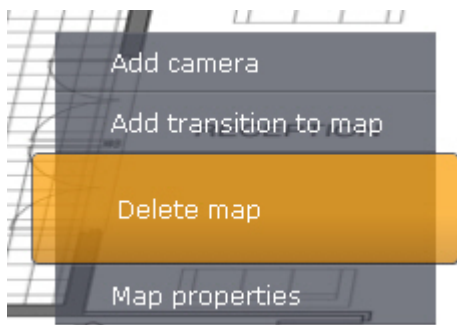

## Configuring Forensic Search in Archive

To make it possible to perform Forensic Search of the archives of a video camera, the following conditions must be met:

1. Video meets the requirements.
2. There are video stream recordings from the desired video camera in the archive.
3. There are metadata recordings from this video stream in the object trajectory database.
4. The user has the appropriate permissions.

This section contains information on how to configure the Axxon Next software package to satisfy these conditions.

### Play corresponding video

## Video suitability for Forensic Search of recorded video (requirements)

For Forensic Search of recorded video to be possible, video must meet the same requirements as those applied to video for detection tools (see [Video suitability for detection tools \(requirements\)](#)).

In addition, the minimum and maximum detectable object speeds in video are related to the camera's frame rate.

1. The maximum detectable speed depends on the size of the object. The following table shows the relationship between the maximum detectable speed and the frame rate for typical objects (people and cars):

Frame rate	Maximum detectable speed for people	Maximum detectable speed for cars
6 fps	5 km/hr	40 km/hr
12 fps	10 km/hr	85 km/hr
25 fps	20 km/hr	170 km/hr

So if it is necessary, for example, to detect people moving at speeds of up to 10 km/hr, it is sufficient to record at 12 fps.

2. The minimum object speed should be such that the object moves at a rate of at least 1 pixel per frame.

## Possible ways to configure recording to the video stream archive

Any of the following recording modes allow using Forensic Search for a camera's archive footage (see the section [Configuring Recording of the Video Stream from Video Cameras to the Archive](#)):

1. Constants recording.
2. Initiated recording.
3. Scheduled recording.

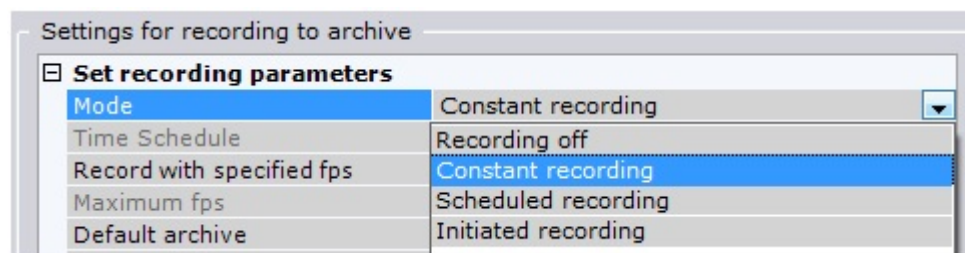

## Enabling recording of video stream metadata

To enable recording of video stream metadata, you must perform the following steps:

1. Switch to the **Detection Tools tab** under **Settings**.

2. Enable situation analysis (see the section [Enabling Situation Analysis](#)).
3. Select **Yes** in the object trajectory recording list.

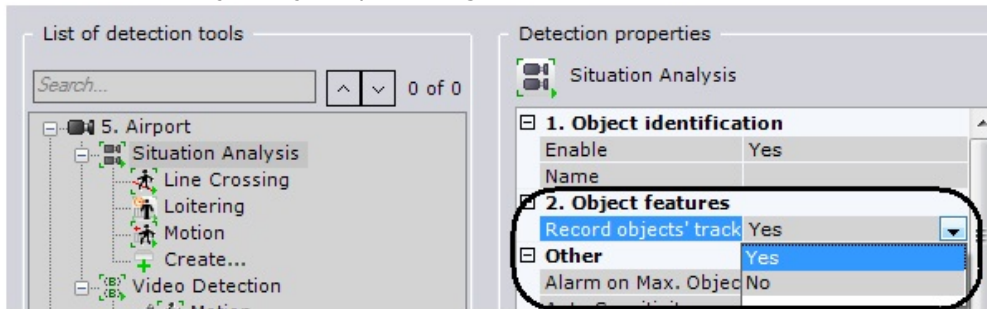

4. Click the **Apply** button.

Recording of video stream metadata will then be enabled. The video stream metadata will be recorded to the object trajectory database when the video stream is recorded to the archive.



**Note**

Information on configuring storage of metadata is provided in the section titled [Configuring storage of the archive, system log, and metadata](#)

## Configuring user permissions for Forensic Search in archive

To use the Forensic Search in archive, it is sufficient to have **Monitoring and Archive** or **Monitoring/Archive/Armed Mode** permission (see the section [Creating and Configuring the Role and User System Objects](#)).

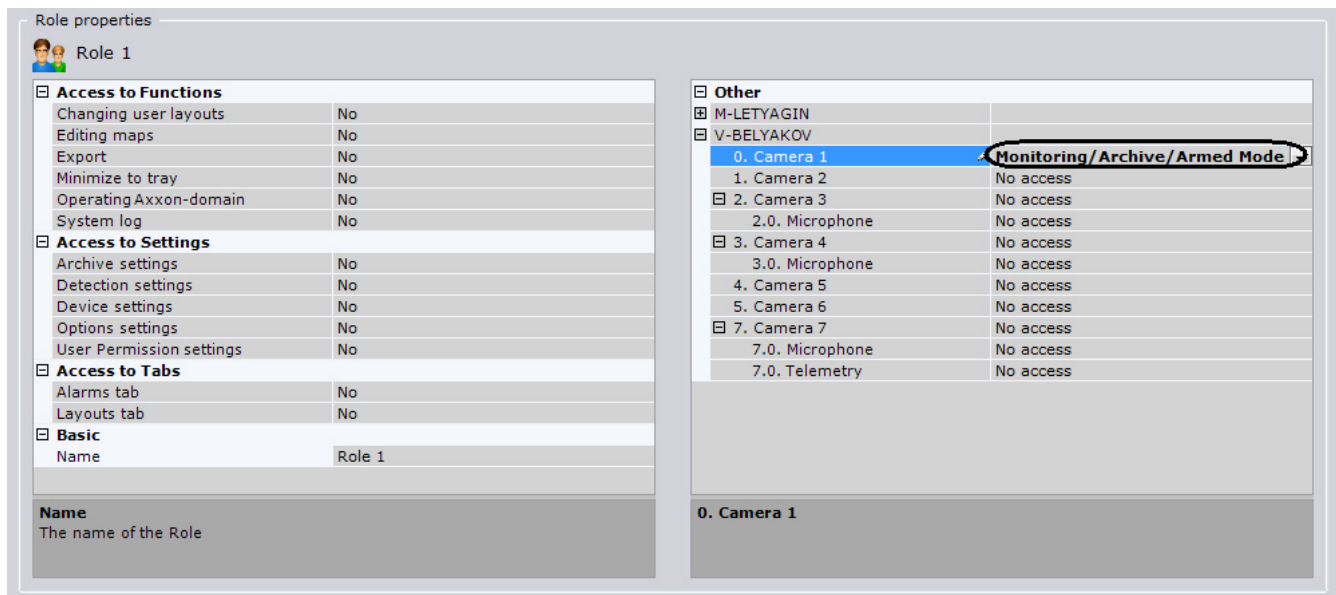

## Configuring the user interface

[Play corresponding video](#)

### Selecting the interface language

When working with *Axxon Next*, the user can choose the interface language.

To select the interface language, complete the following steps:

1. Go to **Settings Options Regional settings (1-2)**.

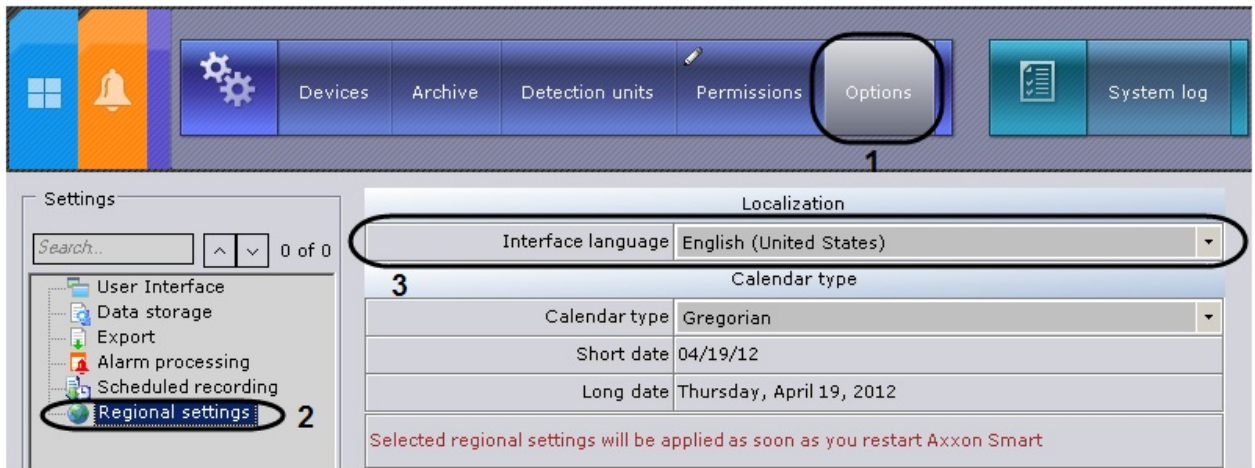

2. Select an interface language from the interface language drop-down list (3).
3. Click **Apply** to save the changes.
4. Restart *Axxon Next*.

The newly selected interface language will be applied once *Axxon Next* is restarted.

[Play corresponding video](#)

## Selecting the calendar type

When working with *Axxon Next*, the user can choose the type of calendar used (Gregorian or Persian).

To select the interface language, complete the following steps:

1. Go to **Settings Options Regional settings (1-2)**.



2. Select the calendar type that is used in *Axxon Next* from the calendar drop-down list (3). The short and long forms of dates are also displayed in their respective fields (4).
3. Click **Apply** to save the changes.
4. Restart *Axxon Next*.

The newly selected calendar type will be applied once *Axxon Next* is restarted.

[Play corresponding video](#)

## Configuring Slideshow parameters

Slideshow mode is a cyclical switching of layouts according to an assigned frequency (dwell-time). Slideshow is launched using the context menu of the layouts ribbon.

To configure the slideshow dwell-time, perform the following:

1. Go to **Settings Options User interface (1-2)**.

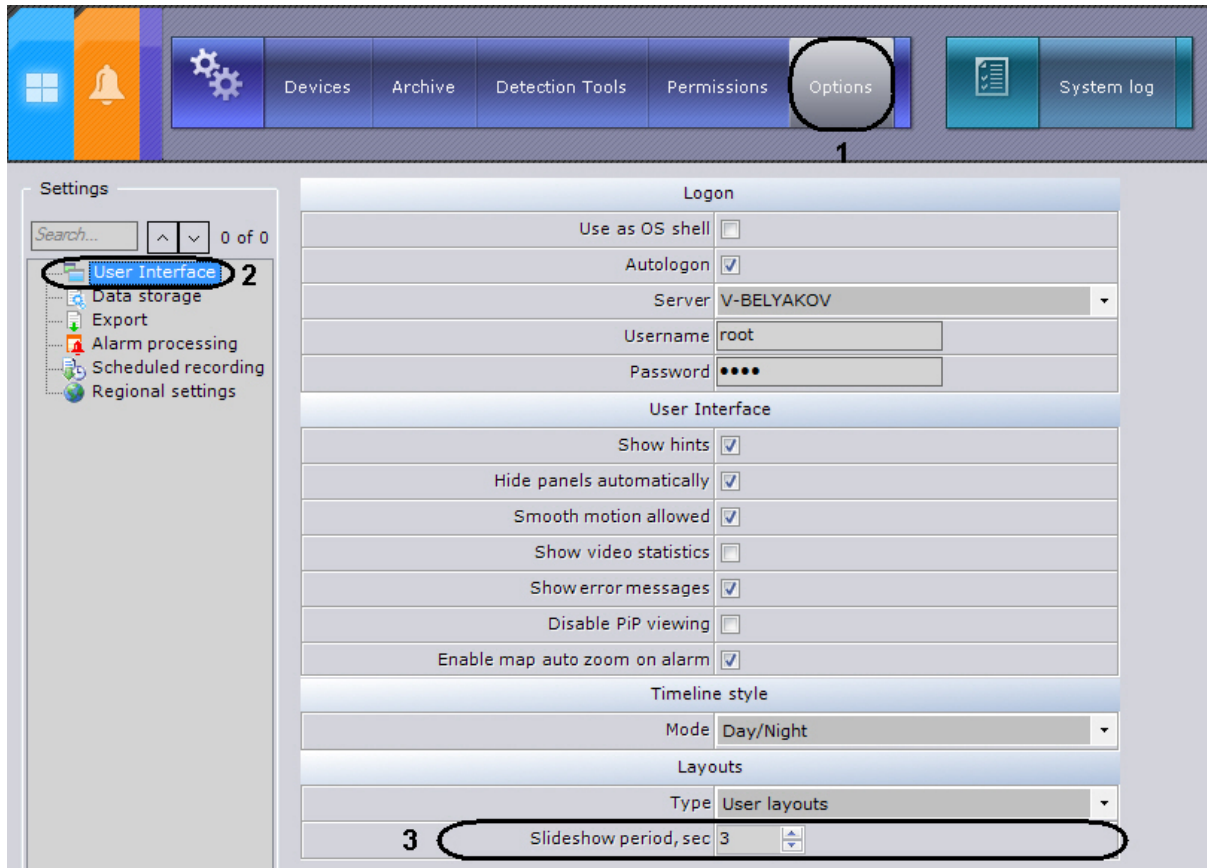

2. Set the slideshow dwell-time, in seconds, in the corresponding field (3).
3. Click **Apply** to save the changes.

The slideshow dwell-time is now set.



**Note**

Switching layout modes is allowed only for users with **Layout configuration** permissions

## Hiding tooltips

In Axon Next, tool tips are displayed when the cursor is moved over a control element. Tooltips are enabled by default. To turn off tooltips, perform the following:

1. Go to **Settings Options User interface (1-2)**.

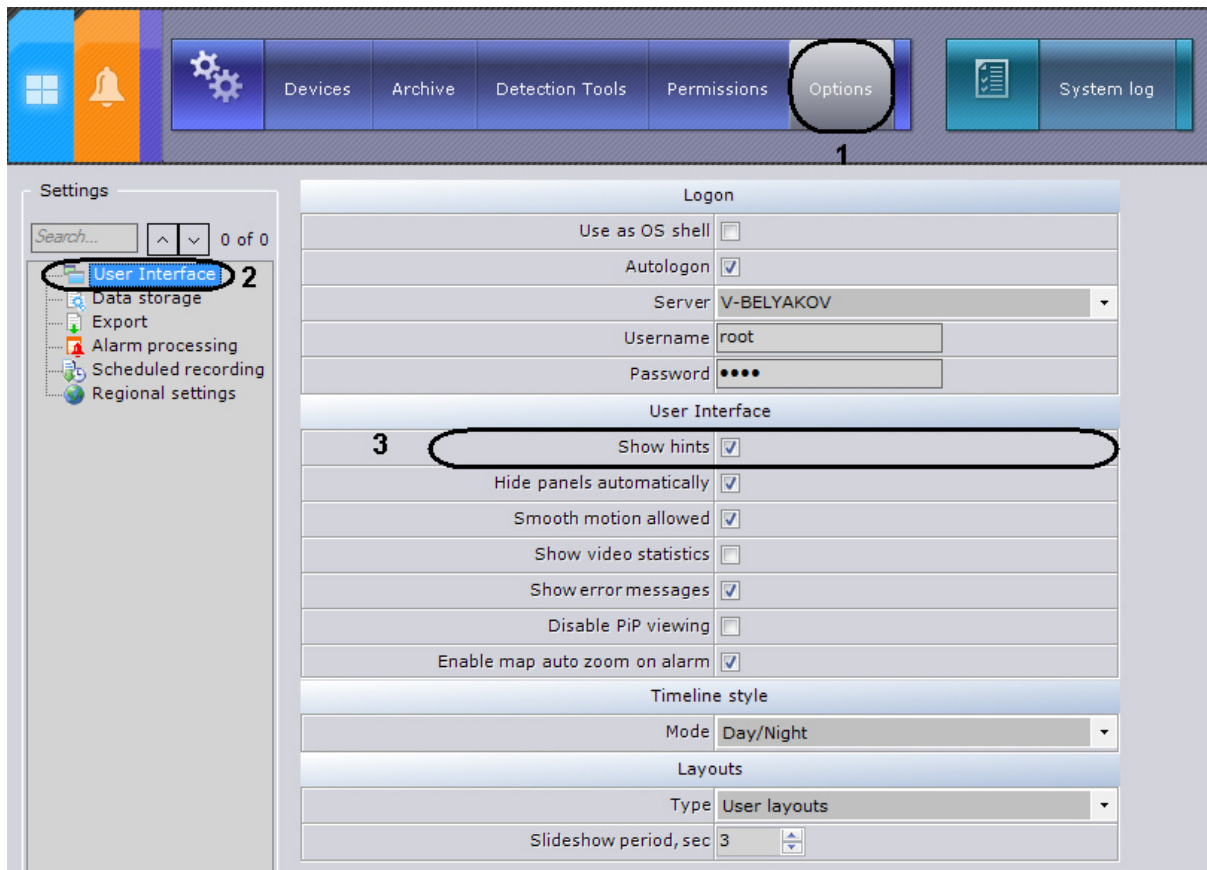

2. Clear the **Show hints** check box (3).
3. Click **Apply** to save the changes.



Tooltips are now disabled. Tooltips can be re-enabled by simply selecting the **Show hints** check box.

## Configuring auto hide for panels

Autohide entails hiding the top panel in the **Layouts** and **Alarms** tabs if there is no input from the keyboard or mouse.



### Important!

Autohide is not performed if the  button in the upper right-hand corner is not activated. When the button is pressed, it looks like this: .

When input from the keyboard or mouse begins, the top panel is displayed in shrunken form, and when the mouse is rolled over it, it is displayed in expanded form.

Auto hide is enabled by default.

To turn off auto hide for panels, perform the following:

1. Go to **Settings Options User interface (1-2)**.

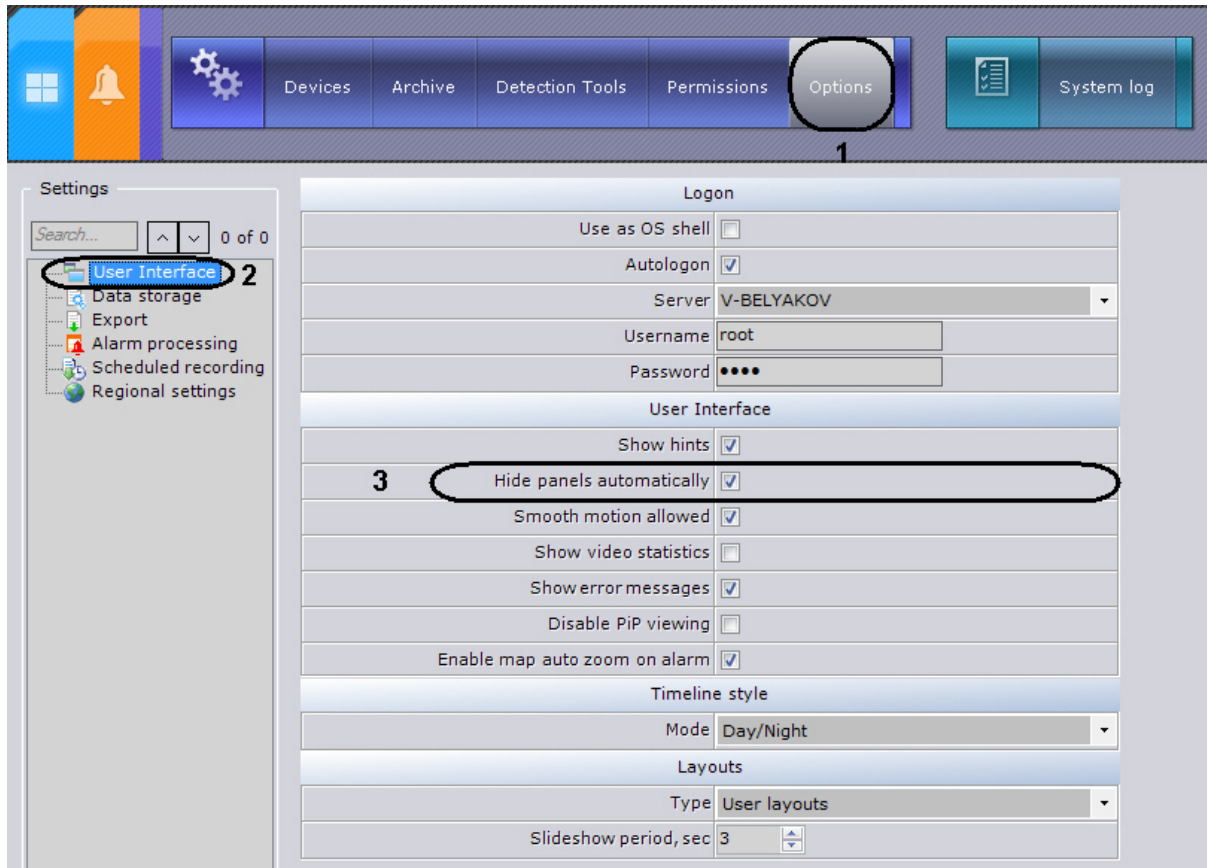

2. Clear the check box for hiding ribbons automatically (3).
3. Click **Apply** to save the changes.

Automatic hiding of panels will now be disabled.

## Configuring animation

Smooth motion is needed to smoothly change the position of viewing tiles, as well as for smooth switching between tabs. Animation for viewing tiles is enabled by default. To disable this option, perform the following:

1. Go to **Settings Options User interface (1-2)**.

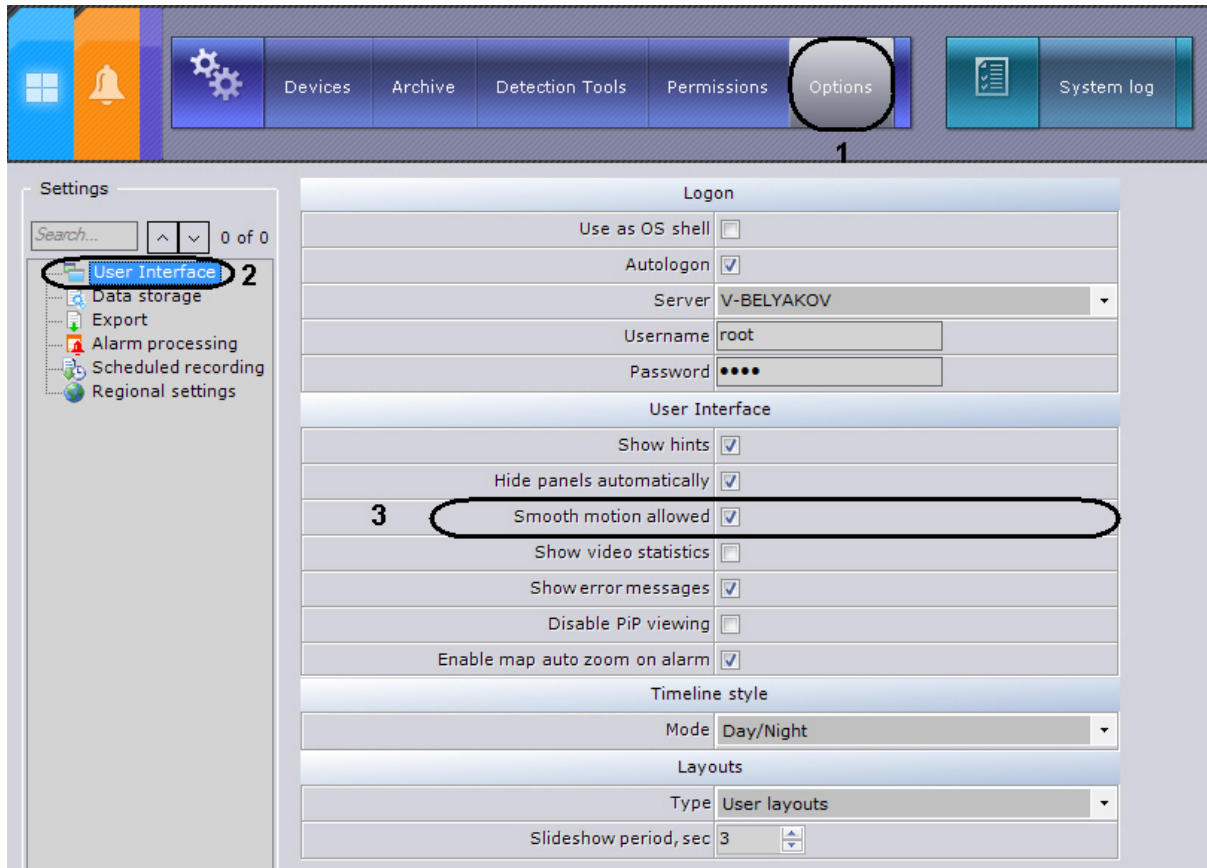

2. Clear the **Use animation** check box (3).
3. Click **Apply** to save the changes.

Animation for viewing tiles will now be disabled.

## Configuring Display of Video Statistics

You can display the following video statistics in the viewing tile:

1. Frame rate of the displayed video stream
2. Frame rate of the video stream received from a video camera or an archive
3. Bit rate of a compressed video stream
4. Resolution of the displayed video stream

To use this option you must perform the following steps:

1. Go to **Settings Options User interface (1-2)**.

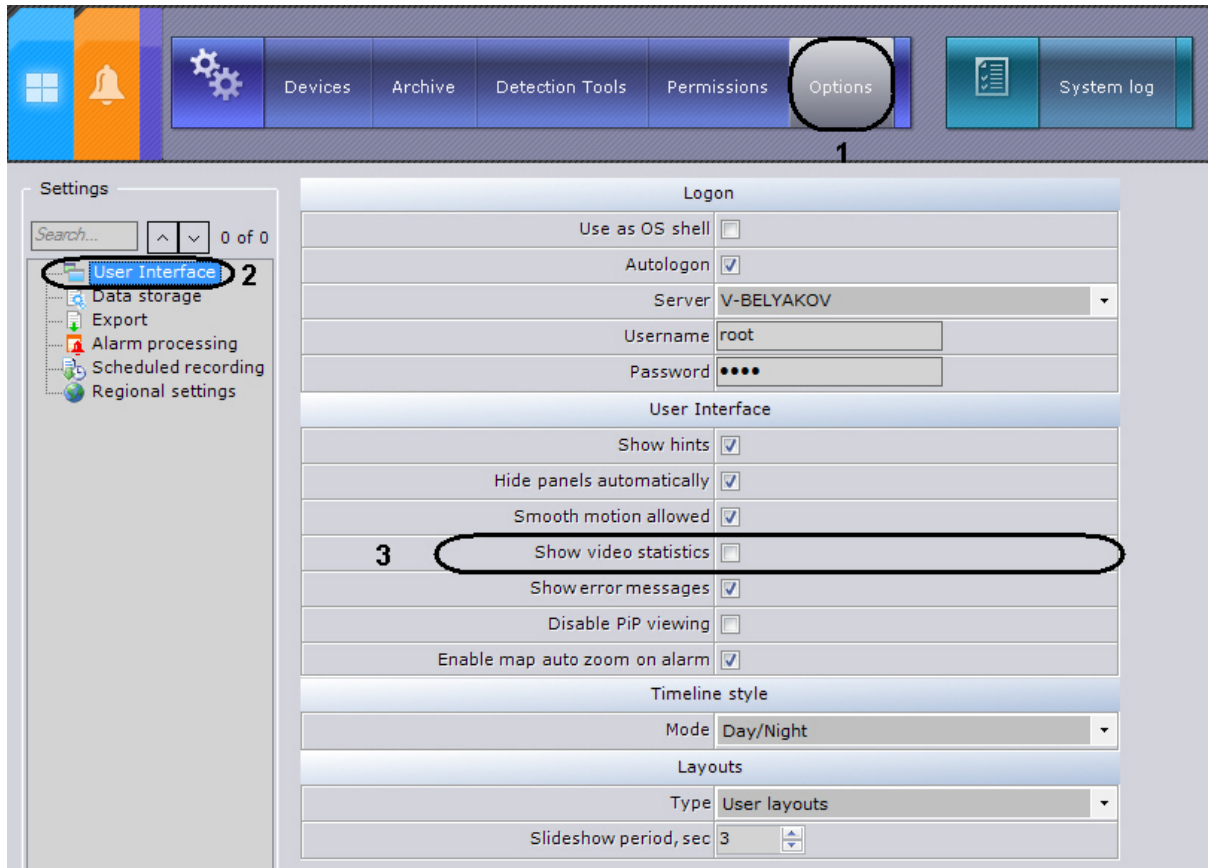

2. Select the **Show video statistics** check box (3).
3. Click **Apply** to save the changes.

The video statistics will now be displayed in the viewing tile for all modes (Live Video, Archive, Alarm, and Archive Search).



## Configuring Display of Error Messages

By default, messages about system errors which have occurred are displayed in real time in the **Layouts** and **Alarms** tabs of the Axon Next software package.

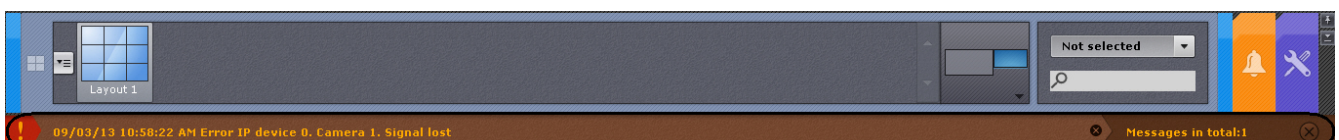

To turn off display of error messages, you must perform the following steps:

1. Go to **Settings Options User interface (1-2)**.

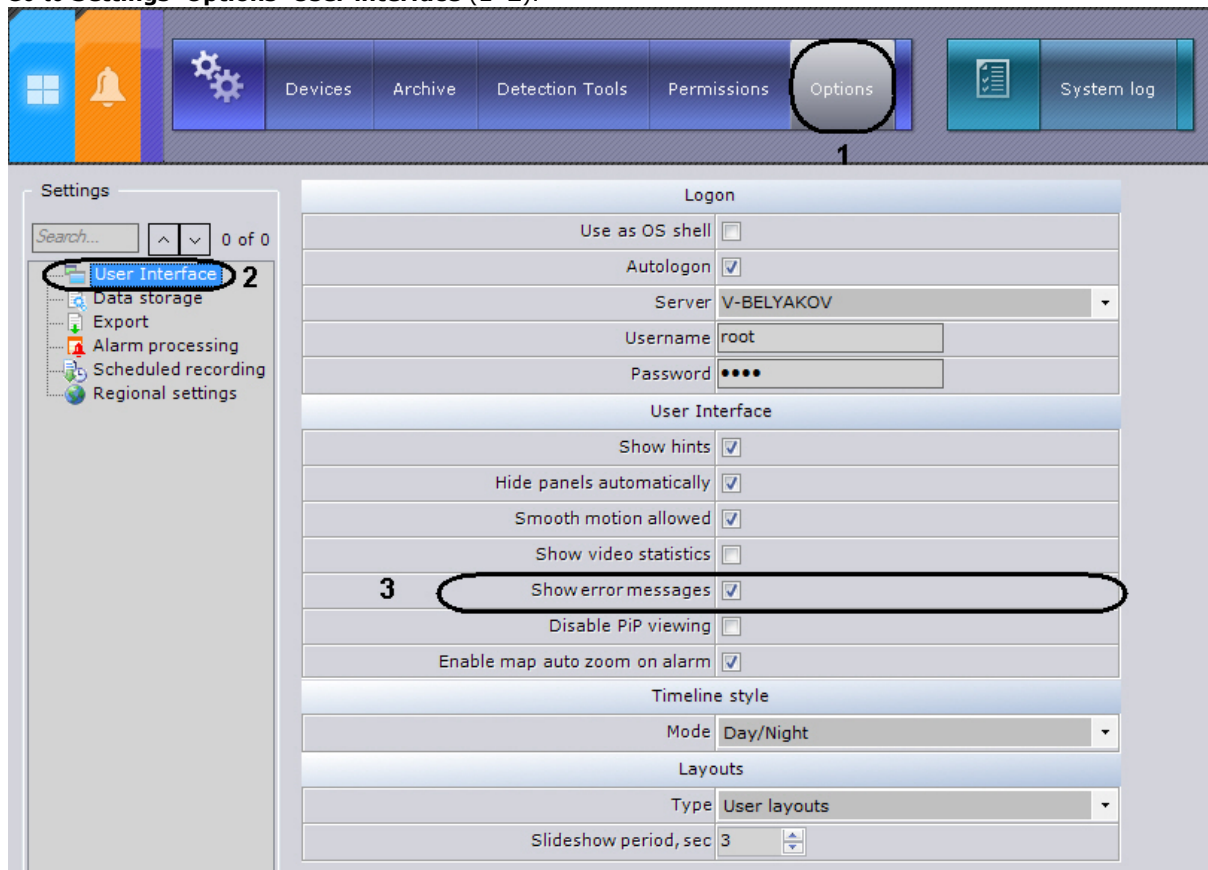

2. Clear the **Show error messages** check box (**3**).
3. Click **Apply** to save the changes.

After you complete these actions, error messages will no longer be displayed.

## Configuring previews of alarm events

You can disable previews of alarm events in the viewing tile.

To do this, follow the steps below:

1. Go to **Settings Options User interface (1-2)**.

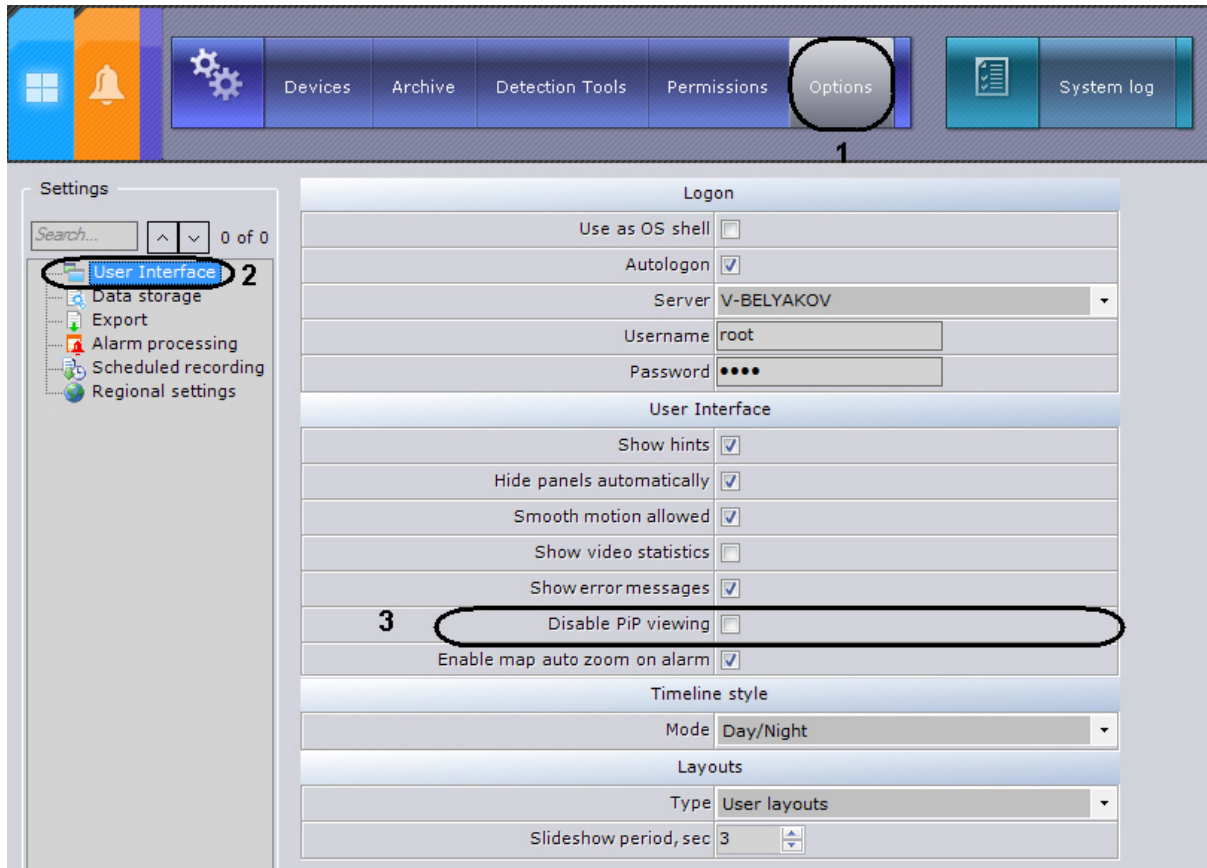

2. Select the **Disable PiP viewing** check box (3).
3. Click **Apply** to save the changes.

After you complete these actions, previews of alarm events will be disabled.

## Configuring map autozoom

When an alarm occurs, the map can be automatically resized and refocused so as to place the icon of the alarm camera at the center of the map. To enable this option:

1. Go to **Settings ->Options ->User interface (1-2)**.

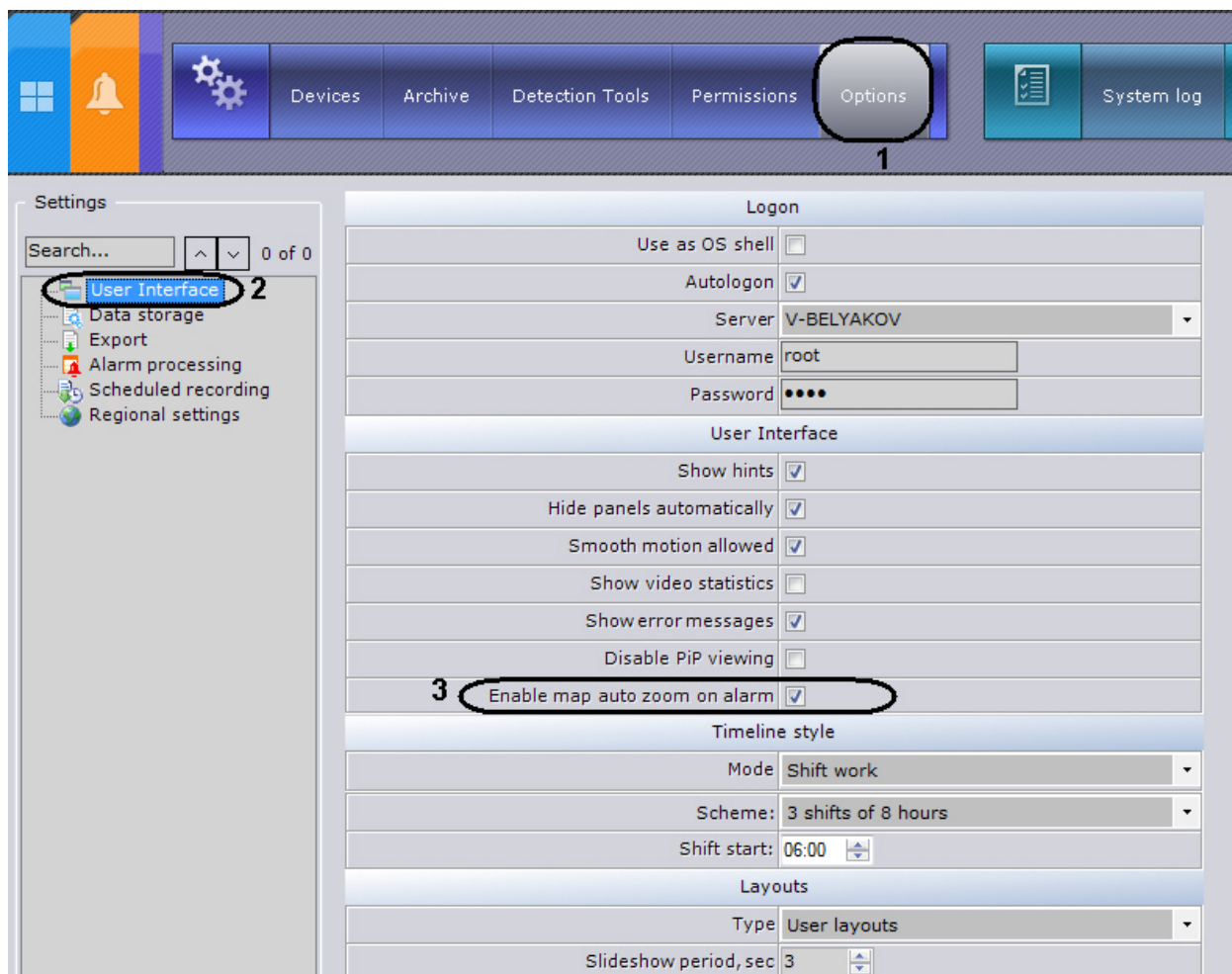

2. Select the **Enable map auto zoom on alarm** (3) check box.
3. Click the **Apply** button to save changes.

## Configuring the timeline

In Axon Next, a timeline is displayed in the right portion of the video surveillance monitor when a viewing tile is switched to archive playback mode. The external appearance of the timeline can be changed depending on the selected style: **Day/night** or **By shift**.

### Configuring the Day/night style

If the **Day/night** style is selected, the timeline will be displayed in light-colored segments from 6:00 AM to 6:00 PM and dark-colored segments from 6:00 PM to 6:00 AM.

To set the **Day/night** style for the timeline, you must perform the following steps:

1. Go to **Settings Options User interface (1-2)**.

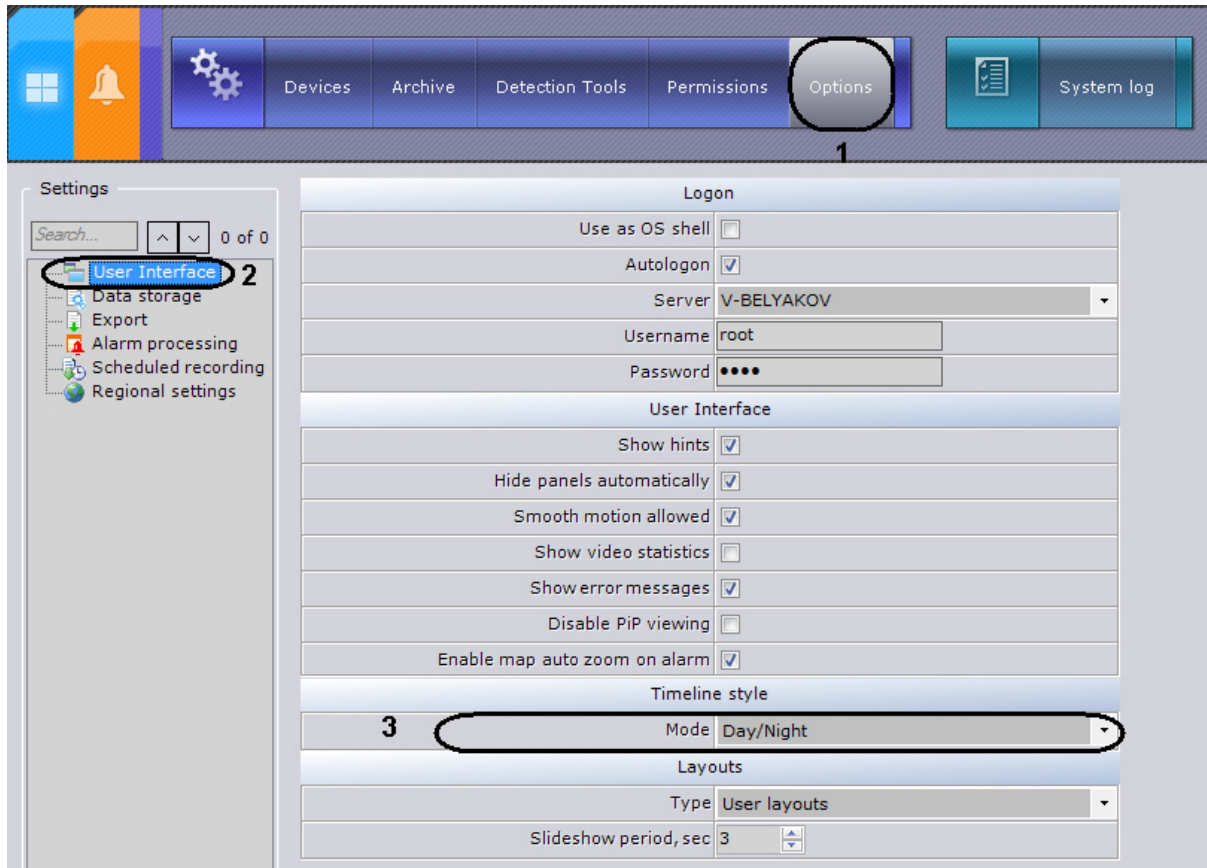

2. Select **Day/night** from the **Mode** drop-down list in the **Timeline style** settings group (3).
3. Click **Apply** to save the changes.

The timeline will now look like the one pictured in figure when viewing an archive.

## Configuring the Shift work style

If the **Shift work** style is set, the timeline will be displayed in alternately colored segments (depending on the number of shifts set per day and the beginning of the first shift). Each segment contains an identification number for each shift. In Axxon Next, the user can choose 3 types of shifts (three 8-hour shifts, two 12-hour shifts, or one 24-hour shift).

To configure the **Shift work** style, you must perform the following steps:

1. Go to **Settings Options User interface (1-2)**.

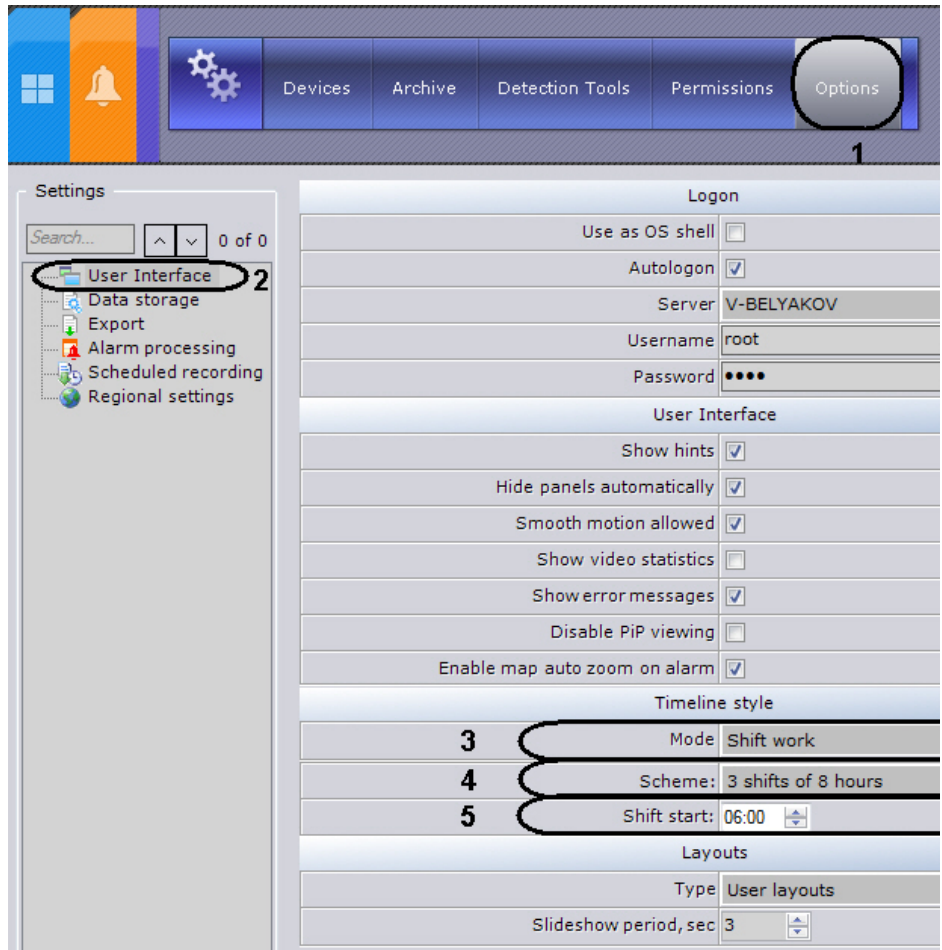
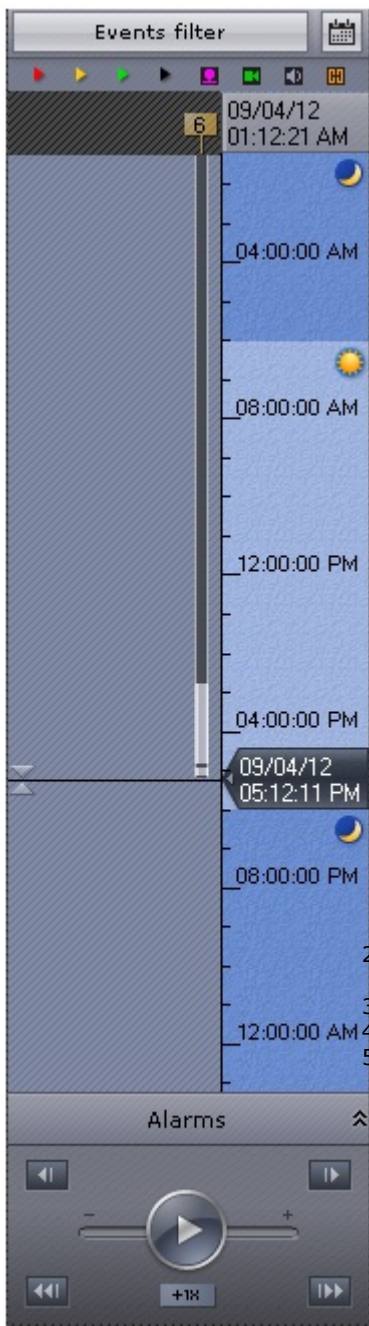

2. Select **Shift work** from the **Mode** drop-down list in the **Timeline style** settings group (3).
3. Select the shift type from the **Scheme** list (4).
4. Define the start time of the shift (5).
5. Click **Apply** to save the changes.

The timeline will now look like the one pictured in figure when viewing an archive.

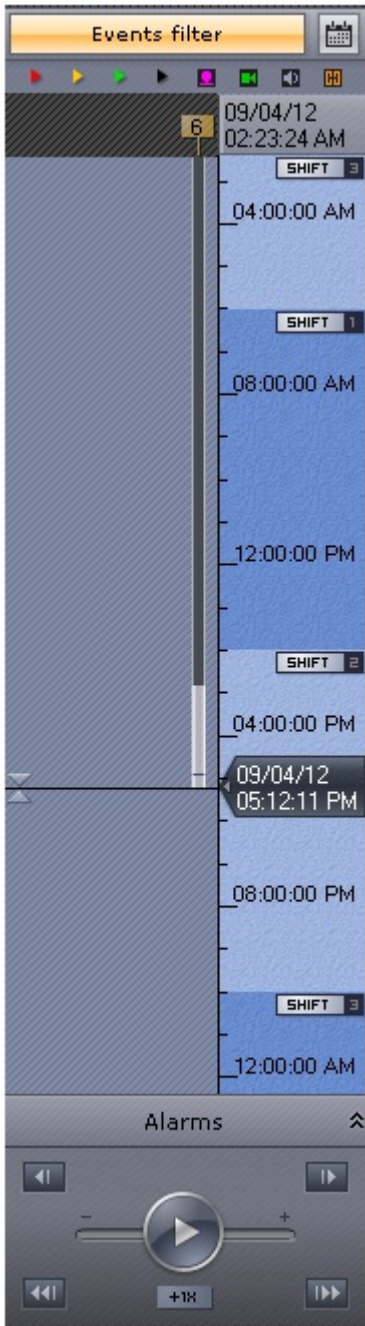

## Configuring Interfaces on a Multi-Monitor Computer

In Axxon Next, you can create several separate viewing tiles for display on additional physical monitors that are connected to a server or client. The number of separate tiles is equal to the number of connected physical monitors.

If the system has more than one monitor connected, the monitor configuration panel is available on the **Layouts** tab.





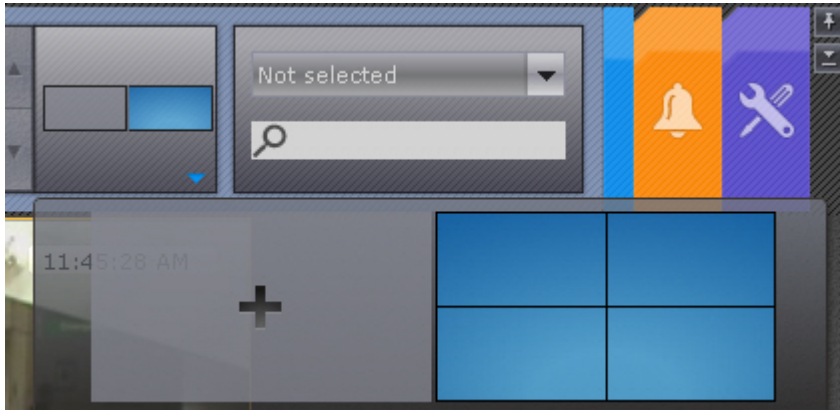

To create and configure a tile on an additional monitor:

1. Click on the monitor configuration panel. Thumbnails of the connected monitors appear.



The thumbnails may appear differently, depending on the status of the monitors in Axxon Next.

Thumbnail	Monitor status
	Main monitor
	Unassigned additional monitor
	Inactive additional monitor
	Active additional monitor

2. To activate an unassigned additional monitor in Axxon Next, click its thumbnail. The additional monitor becomes active and the layout of the main monitor is duplicated to it.
3. Configure the layout of the additional monitor. You can configure the layout of the additional monitor through the main monitor (the additional monitor must be active). Changes affect only the additional monitor; the layout of the main monitor is not changed.
4. Click the thumbnail of the main monitor. The additional monitor becomes inactive and the original layout is displayed on the main monitor. If the additional monitor becomes inactive, editing of the layout does not affect it.

Creation and configuration of the additional monitor is now complete.

Later editing of the layout on the additional monitor is performed as follows:

1. Activate the additional monitor (by clicking its thumbnail).
2. Edit the layout.
3. Make the additional monitor inactive.

To close an additional monitor in Axxon Next, on its thumbnail, click the  button.

## Configuring the Client screen mode (full screen or window)

By default, the Client (main monitor and all additional monitors) is displayed in full-screen mode.

It is possible to use window mode both on the main monitor and on additional monitors. Do the following:

1. Go to **Settings ->Options ->User interface (1-2)**.

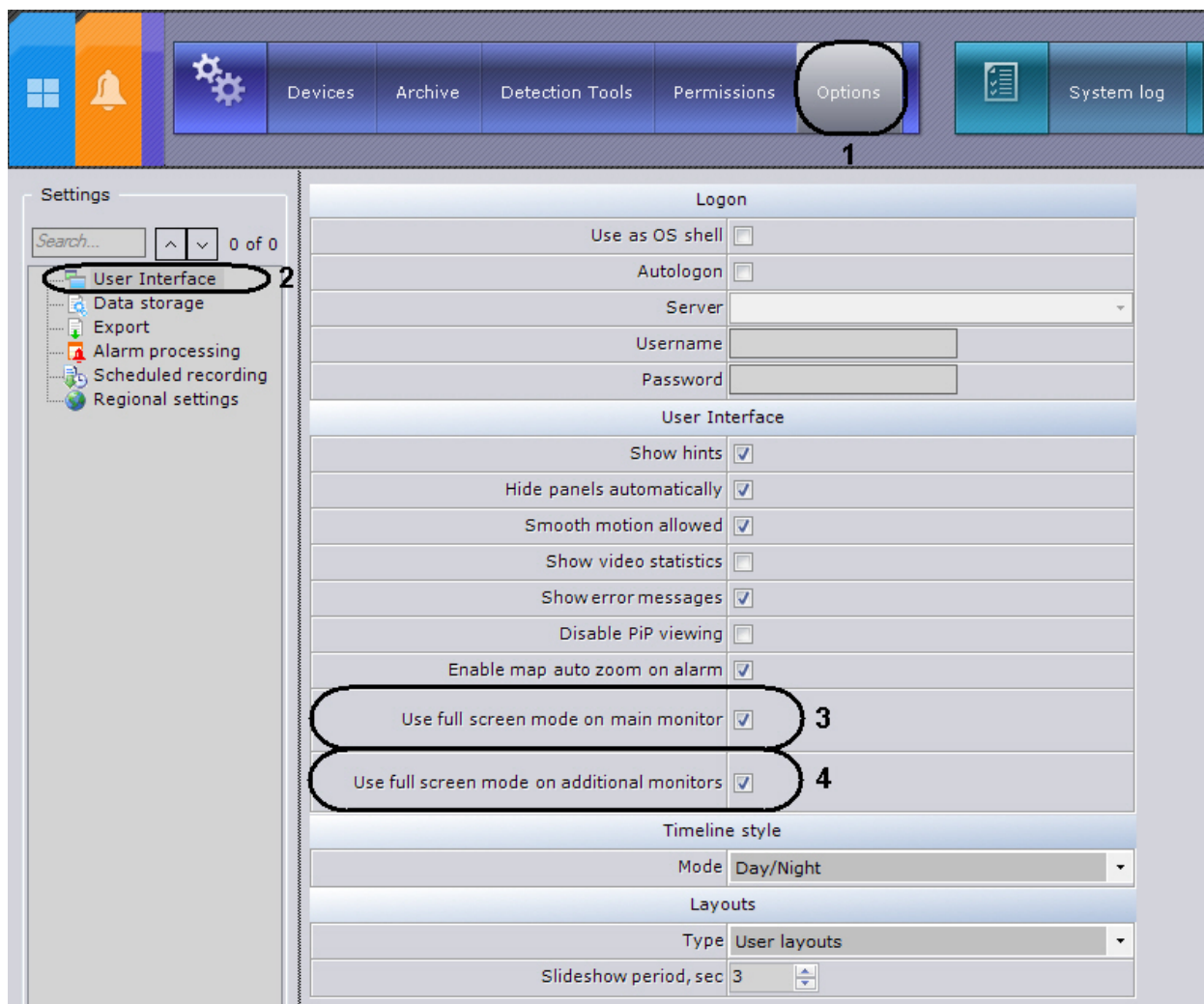

2. To use window mode on the main monitor, clear the **Use full screen on main monitor** check box (3).
3. To use window mode on additional monitors, clear the **Use full screen on additional monitor** check box (4).
4. Click the **Apply** button to save changes.

For changes to take effect, quit the Client and start it again.

## Configuring how Axxon Next starts

[Play corresponding video](#)

### Configuring Axxon Next instead of the standard Windows OS shell

Autorun of Axxon Next, instead of the standard Windows OS shell, is used in cases where you need to restrict access to computers running the digital video surveillance system, including preventing the launch of various applications, file copying and deletion, various Windows operations, and other non-standard use of the computers.

If you configure *Axxon Next* to autorun instead of the standard Windows shell, *Axxon Next* will launch instead of Windows *Explorer* immediately after Windows loads. This makes it impossible for the user to launch certain applications installed on the computer or to work with certain program dialog boxes.

To activate autorun of the Axxon Next software package instead of the standard Windows shell, select the **Use as OS shell** check box in **Settings Options User interface** and click **Apply**.

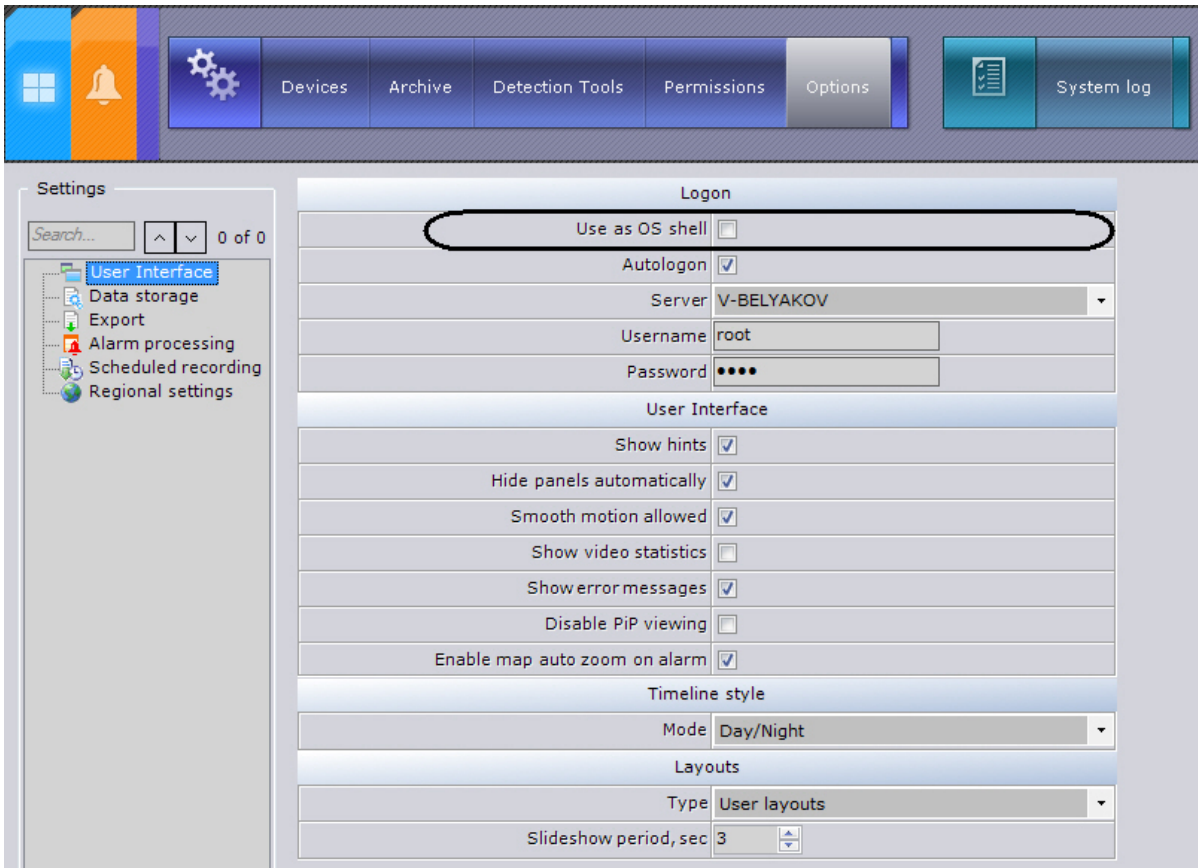

Axxon Next will now launch instead of the standard Windows shell the next time you start Windows.



**Note**

If User Accounts Control is enabled in the Windows OS, this option will not be available and the **Use as OS shell** check box will be grayed out. If this check box was selected before UAC was enabled, you can remove it

## Configuring autologon

Axxon Next allows automatic user authorization when a Client is started.

To configure autologon, complete the following steps:

1. Go to **Settings Options User interface (1-2)**.

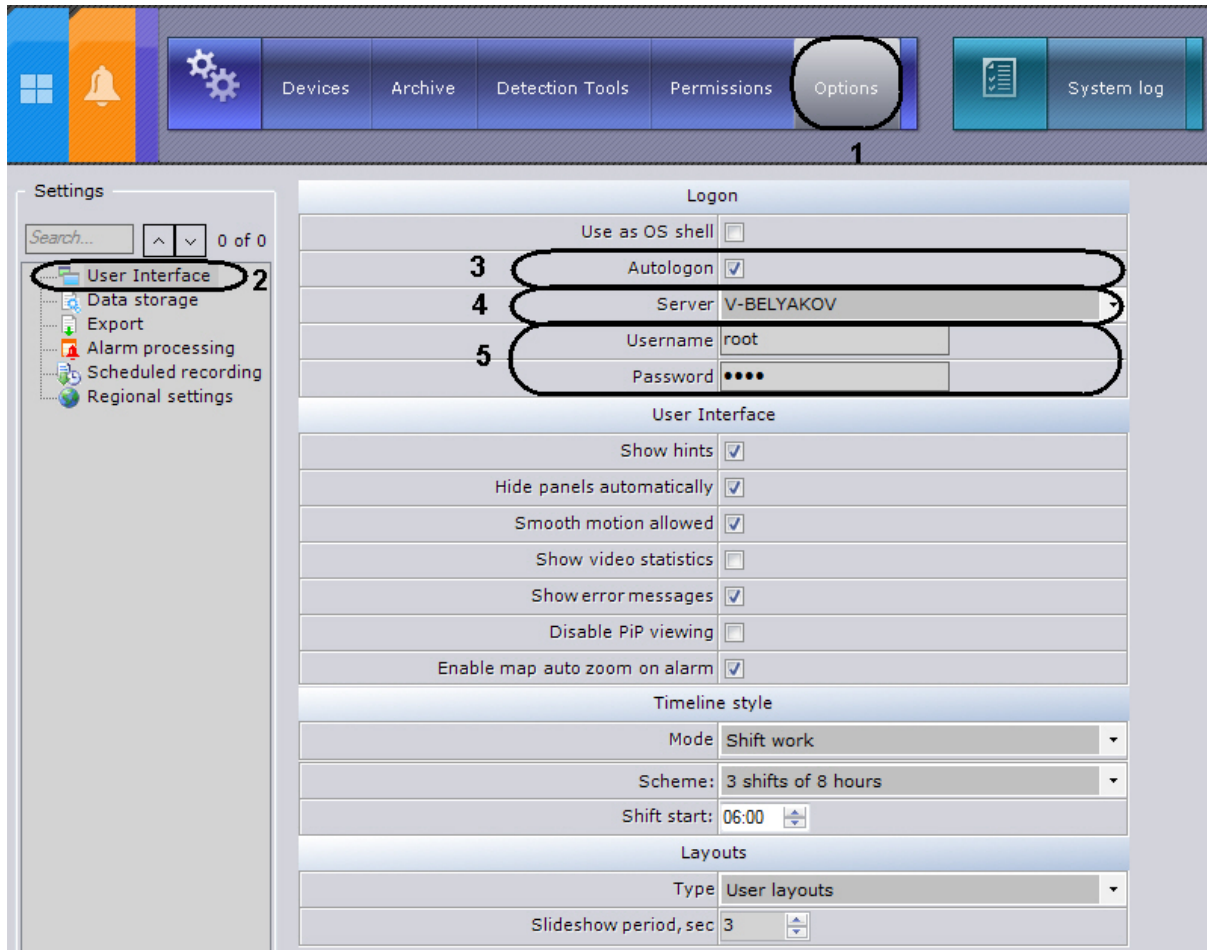

2. Select the **Autologon** check box (3).
3. From the Server list, select the Server you need to query for automatic authorization (4).
4. Enter the user name and password to be used for automatic authorization (5).
5. Click the **Apply** button.

Configuration of autologon is now complete. Once *Axxon Next* is restarted, it will automatically connect to the selected Server under the specified user.



**Note**

In this case, *Axxon Next* will enable only those functions that correspond to the rights and permissions of the specified user

## Configuring storage of the archive, system log, and metadata

The system log is a log containing system information on events, including system error entries.

The system log is stored in a local database for each server. You can set access to the system log for a user group in the **Permissions** tab under **Settings** (see the section titled [The Role object](#)).

To configure storage of the archive, system log, and metadata:

1. Go to **Settings Options User interface (1-2)**.

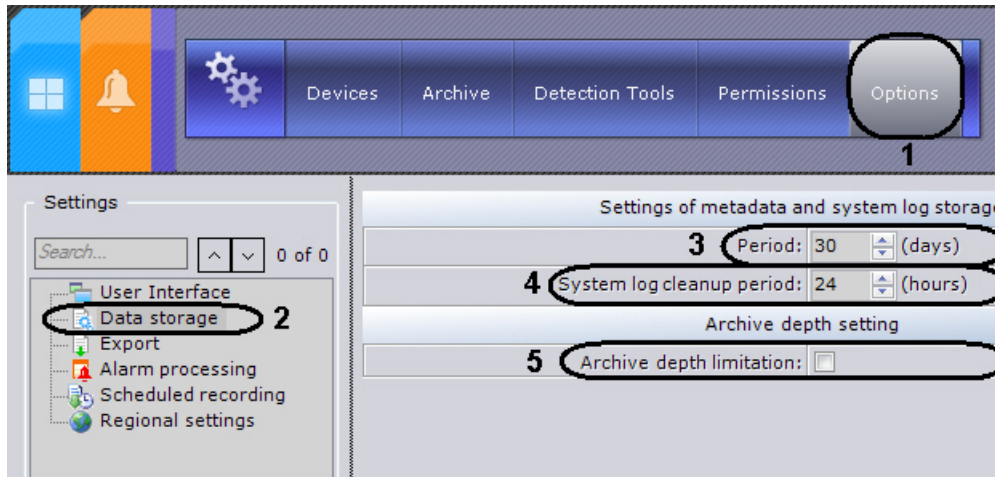

2. In the **Period** field, enter the amount of days to store the system log in the Server's database and to store metadata in the object trajectory database (**3**).
3. In the appropriate field, enter the amount of hours after which outdated events will be purged from the system log (**4**).

Outdated events are events that have been stored in the system log for a period greater than that indicated in step 2.



**Note**

Every 12 hours after Axxon Next is started, the object trajectory database is purged of video recordings that have been stored for more than the specified storage period

4. If you want to limit the archive capacity, select the corresponding check box and specify the archive capacity in days (**5**). If a limit is set, only video within the specified time frame will be available in the archive. Recordings that exceed the specified archive capacity will only be hidden; they will not be deleted.
5. Click the **Apply** button.

Configuration of the system log is now complete.

## Configuring export

Configuration of export of video recordings or frames consists of selecting folders for saving exported files and activating automatic export of snapshots.

By default, files are exported to C:\Documents and Settings\User\My Documents\AxxonSoft\Export on Windows XP. On Windows 7 and Windows Vista, the default folder is : \Users\User\Documents\AxxonSoft\Export.

To change export settings, you must perform the following steps:

1. Go to **System settings Options Export (1-2)**.

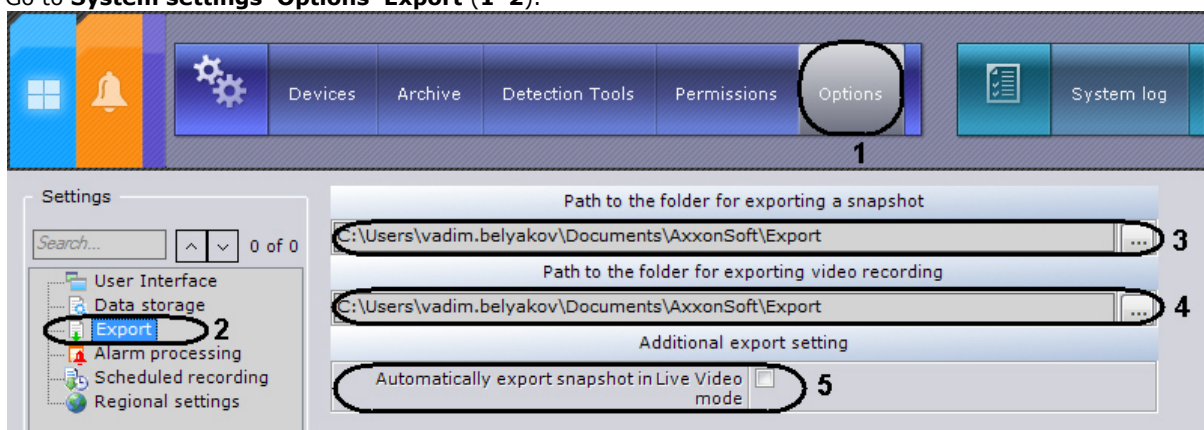

2. In the **Path for snapshot export (3)** and **Path for video export fields (4)**, enter the full path to the folders where exported files are to be saved. To do this, click the button .



**Attention!**

If you modify the paths to exported file folders on one computer, those paths will also be changed on all computers in the Axxon Domain and on all Clients

3. If you need to automatically export snapshots while "freezing" video in real time, select the corresponding check box (**5**).

- Click the **Apply** button.

Changing the export settings is now complete.

Exported video recordings will be stored in .mkv format; video frames will be stored in JPG format.

## Configuring Alarm Management Mode

You can set the following parameters for alarm handling:

- The maximum allowed time for ignoring alarms is the length of time a new alarm can remain unaccepted for handling by an operator before it is assigned **Unclassified** status and is deleted from the **Alarms** tab.

**Note**  
To begin processing an alarm, you must switch to Alarm Management mode

**Note**  
The time allowed for evaluating an alarm after accepting it for handling is not limited

**Note**  
If the operator is in Alarm Management mode and activates a tile from another video camera, Alarm Management mode will close

- The maximum allowed reaction time to an alarm is the length of time from the moment the operator who accepted an alarm for processing exits alarm mode, after which the alarm returns to **New** status, and the count for the allowed time for ignoring an alarm begins again.

**Note**  
For example, an operator can exit alarm mode to view the video archive related to the alarm

- Requirement for comments when classifying alarms in Alarm Management mode.

To configure alarm handling in the system, you must perform the following steps:

- Go to **Settings Options Alarm processing (1-2)**.



- In the **Alarm pending time** group, enter the time in seconds during which it is necessary to accept the alarm for processing before it is assigned the **Unclassified** status (**3**).
- In the **Operator's idle time** field, enter the time in seconds during which an operator who accepted an alarm for processing and exited alarm mode without evaluating it must return to alarm mode (**4**).
- Select the alarm classifications for which you want to require comments (**5**).
- Click the **Apply** button.

Configuration of alarm handling is now complete.

[Play corresponding video](#)

## Configuring schedules

A schedule consists of all the time intervals for which video streams from video cameras will be recorded to archive.

[Play corresponding video](#)

# Creating schedules

To create a schedule, complete the following steps:

1. Go to **Settings Options Scheduled recording (1-2)**.

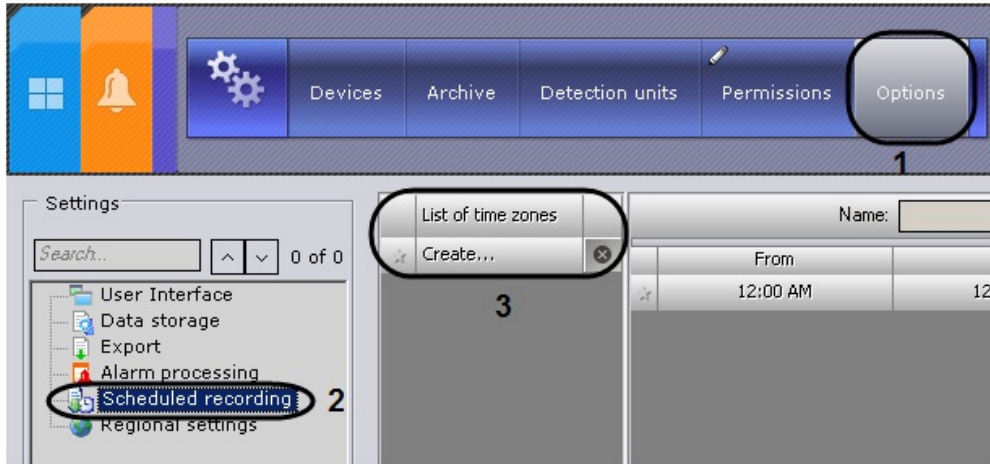

2. Under **List of schedules**, click the **Create...** field and enter the name of the schedule (**3**)
3. Set the time intervals for the schedule:
  - a. Enter the interval's start time in the **From** column with the help of the buttons accessible by left-clicking the appropriate cell twice (**1**).



Button	Action
	Shift the interval start back by 1 hour
	Shift the interval start back by 15 minutes
	Shift the interval start ahead by 15 minutes
	Shift the interval start ahead by 1 hour

- b. Enter the interval's end time in the **To** column with the help of the buttons accessible by left-clicking the appropriate cell twice (**2**).
- c. Select the days of the week to be included in the interval by selecting the appropriate check boxes (**3**).
- d. Create the necessary number of intervals to be included in the schedule

**Note**

To delete a time interval, click in the corresponding row

A visual display of time intervals for each day of the week is provided on the time chart.

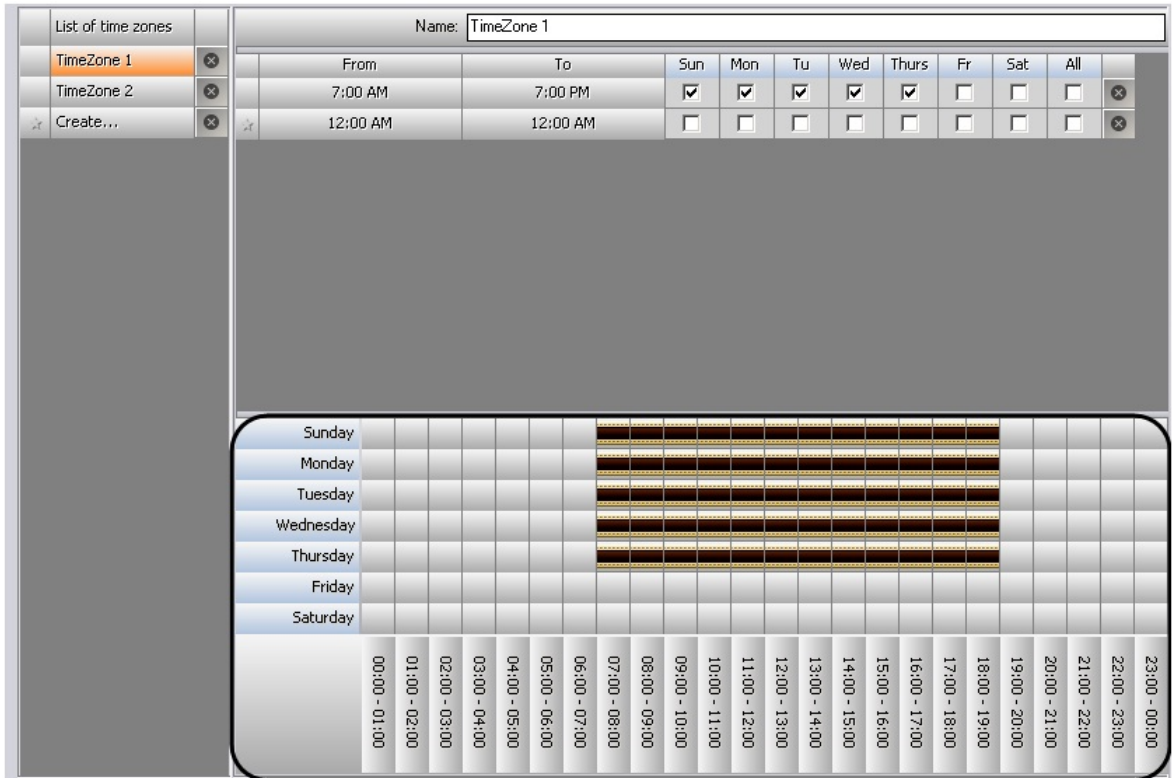

4. Click the **Apply** button.

Creation of a schedule is now complete.

## Deleting a schedule

To delete a schedule, complete the following steps:

1. Go to the list of schedules (under **Settings Options Scheduled recording**).

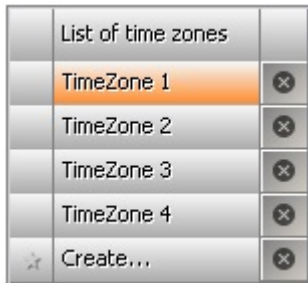

2. Click beside the schedule that you want to delete.
3. Click the **Apply** button.

Deletion of a schedule is now complete.

## Creating and Configuring the Role and User System Objects

In Axxon Next, only one role (**Admin**) and one user (**root**) are registered default.

The user **root** belongs to the **admin** role and possesses permissions to configure all components of the video surveillance system.

To register an operator with individual permissions, you must create a new role with those permissions and a new user account for that user.

Registration and configuration of roles and users is carried out through the **Permissions** tab in **Settings**.

[Play corresponding video](#)

### The Role object

A role is intended for assigning a group of users individual rights and permissions for administration, management and/or monitoring of individual components of Axxon Next.

To register a new role, perform the following:

1. Select a role in the user tree (1).
2. Bring up the context menu of the user tree by right-clicking the mouse.
3. Select **Add role** (2).

**Note**  
To register a new role, you can also click **Create** (3)

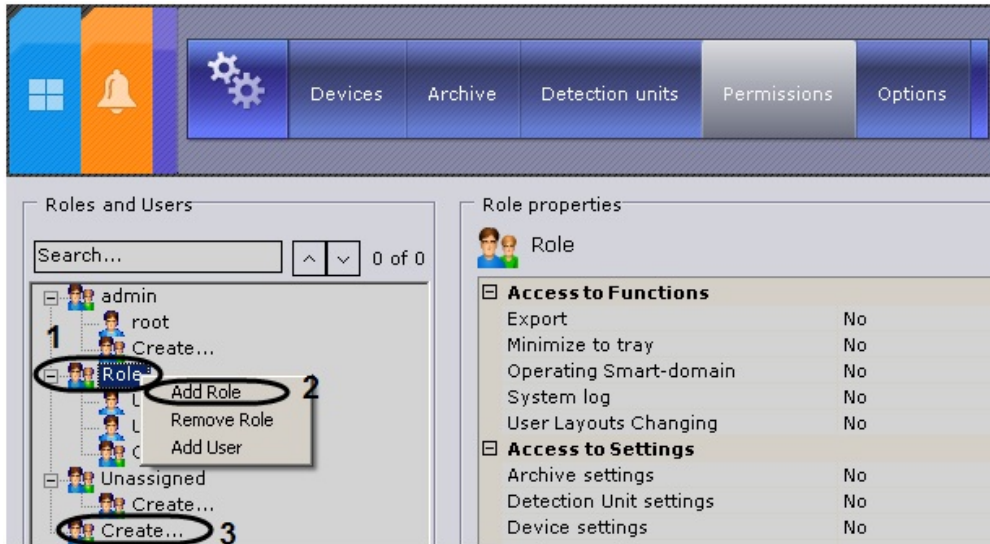

A new role will then appear in the user tree, and the properties of that role will appear on the right.

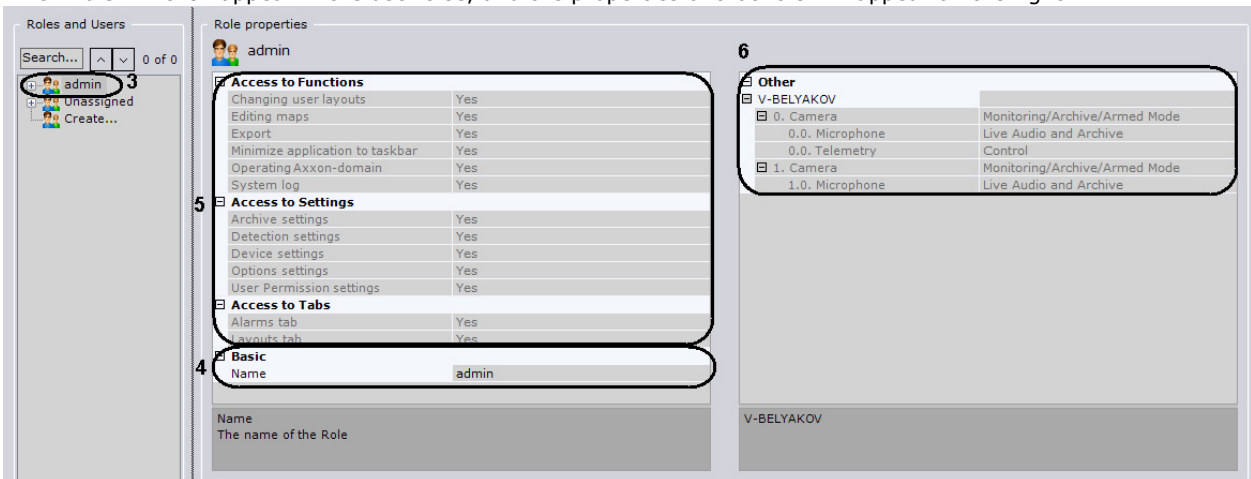

4. Assign a name for the role in the role properties (4).
5. Select **Yes** for the components for which access needs to be granted (5).
6. Select the appropriate permissions to devices (6).

Device	Access permissions	Description
Video camera	No access	Unable to view image from the video camera. Archive is inaccessible.
	Monitoring in Armed mode	The image from the video camera can be viewed only when the video camera is armed. Archive is inaccessible. The user is unable to arm/disarm the video camera.
	Monitoring	The user can view the image from the video camera. Archive is inaccessible.
	Monitoring and Archive	The user can view the image from the video camera. Archive is accessible.

	Monitoring/Archive/Armed mode	All functions are accessible.
Microphone	No access	The user is unable to listen to live sound from the video camera. The user is unable to listen to sound recordings from the archive.
	Live Audio	The user is able to listen to live sound from the video camera (the microphone must be turned on). The user is unable to listen to sound recordings from the archive.
	Live Audio and Archive	All functions are accessible
Telemetry	No access	The user cannot control pan/tilt/zoom
	Control	The user can control pan/tilt/zoom

7. Click the **Apply** button to save the role.

The new role has now been created.

To delete a role, perform the following:

1. In the user tree, select the role that you want to delete (1).

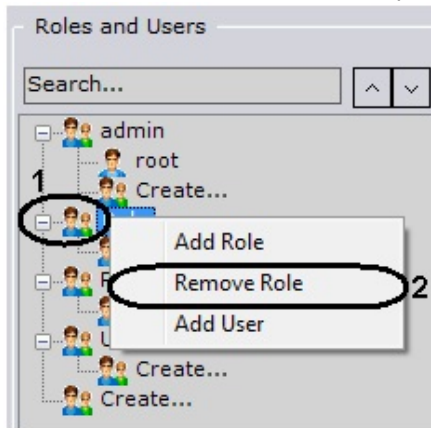

2. Bring up the context menu of the user tree by right-clicking the mouse.

3. Select **Delete role** (2).

**Note**  
You cannot delete a role if the user through which you logged into the system belongs to that role.

4. Click **Apply** to save the changes.

The role has now been deleted. All users that were assigned the specified role will now be placed in the **Unassigned** group.



## The User Object

In Axon Next, several users can be assigned to one role. The user will be granted the permissions for administration, management and/or monitoring that are indicated in the settings of the role. When registering the user, their name and password are specified so that the user can log into the system.

To register the user, perform the following:

1. Select a role in the user tree (1).

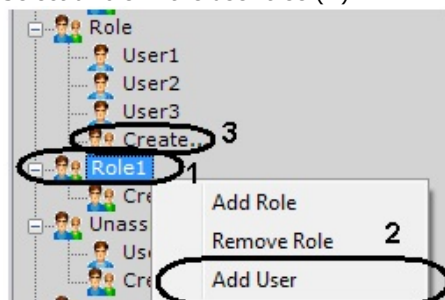

2. Bring up the context menu of the user tree by right-clicking the mouse (2).
3. Select **Add user** (2).

**Note**  
To register a user, you can also click **Create** (3)

The new user will then appear in the user tree, and the permissions configuration panel for that user will open on the right.

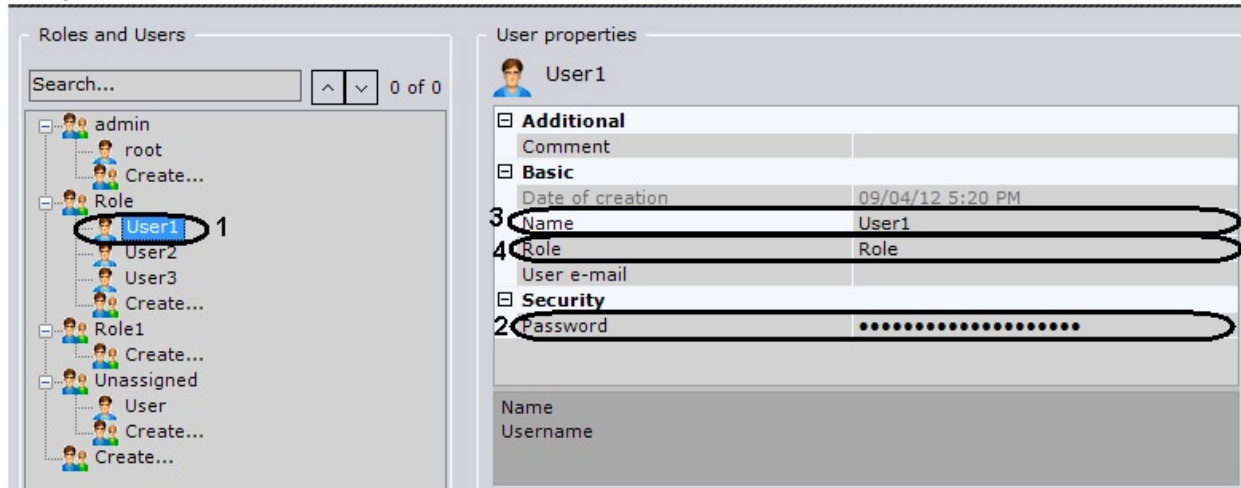

4. Enter the password in the **Security** configuration group (2).

- a. Click . The **Change password** window opens.



- b. Enter the user's assigned password in the **New password** field (1).
  - c. Retype the assigned password in the **Confirmation** field (2).
  - d. Click **OK** to save the settings.
5. Enter the user name in the **Basic** configuration group (3, User properties).
  6. Select a role in the **Basic** configuration group (4, User properties).

**Note**  
If **Role** has an empty value in the drop-down list, the user will be placed in the **Unassigned** group. Users in the Unassigned group will not be able to log in to Axxon Next. To remove a user from the **Unassigned** group, the user must be assigned a role (see step 6)

7. If necessary, enter an e-mail address and additional information about the user in the **E-mail** and **Comment** fields.

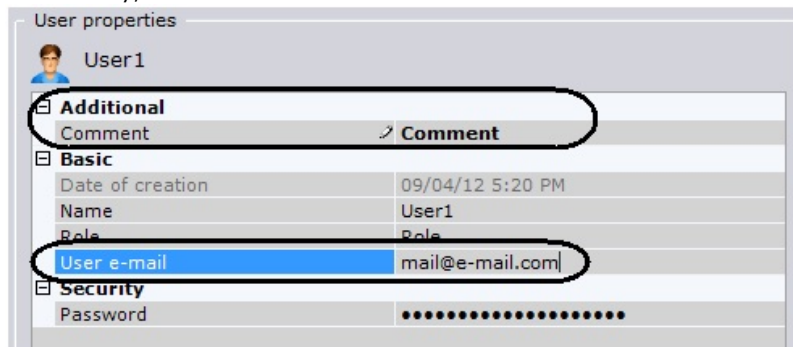

8. Click the **Apply** button to save the settings.

The user has now been registered and added to the user tree.  
To delete the user from the tree, perform the following:

1. Select the user (1).

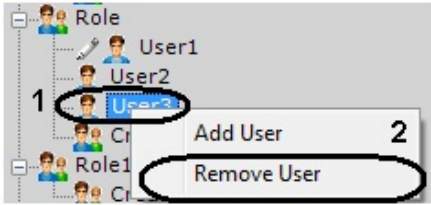

2. Bring up the context menu of the user tree by right-clicking the mouse.
3. Select **Delete user (2)**.



**Note**

You cannot delete the user through which you logged into the system.

4. Click **Apply** to save the changes.

The user has now been deleted from the user tree.

# Working with the Axxon Next Software Package

## Main Elements of the User Interface

### Viewing Tile

A viewing tile is used to display video stream on the monitor of a computer with specific parameters for the purpose of video surveillance, archive viewing, and forensic search in archives. The viewing tile also has a function which allows the generation and evaluation of alarm events in the process of video monitoring of a guarded location.



A more detailed description of the functions of the viewing tile can be found in the section titled [Video Surveillance](#).

### Color Coding of Frames

Color coding of the frame of a viewing tile is used to indicate the status of the video camera.

Color of viewing tile frame	Camera status
Green	Camera disarmed
Yellow	Camera armed
Red	Alarm for this camera

Gray	Archive mode
Dark blue	<b>Snapshot</b> function enabled



**Note**

Color coding for alarm status has priority over color coding for archive and snapshot modes.

## Viewing Tile Context Menu

The viewing tile context menu is used to access the following functions (depending on the enabled surveillance mode):

1. Video surveillance
2. Audio monitoring
3. Exporting frames and recordings
4. Object tracking

To bring up the viewing tile context menu (1), left-click the video camera icon in the upper left-hand corner of the tile (2).



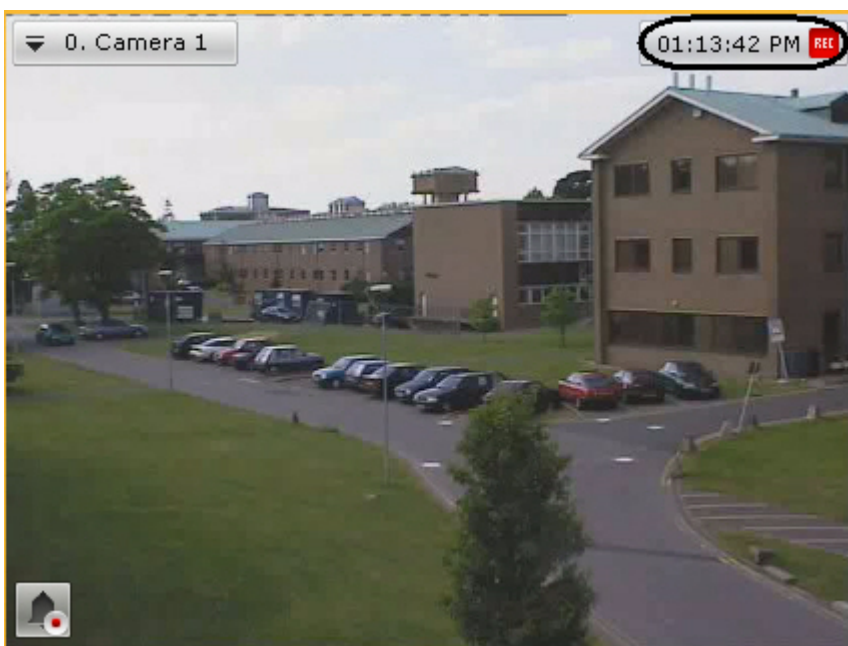

## Time Display

The time display appears in the upper right-hand corner of the viewing tile.

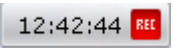

In real-time mode, the time display shows the current time: 

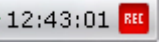
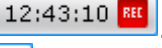
In archive, alarm, and video frame search modes, it shows the time of the fragment being viewed and the playback mode:

1. Forward playback  
2. Reverse playback  
3. Pause  

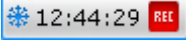
The **Snapshot** function can be enabled in all video monitoring modes, with the help of the :time display. To do this, left-click in the area with the clock. A snowflake will now appear to the left of the clock. 

If recording of video from a video camera is currently underway, a red R is displayed to the right of the clock.

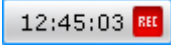
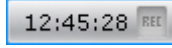
. Otherwise, a gray letter "R" will be displayed. 

## Display of Video Statistics

You can display video statistics in the viewing tile (see the section titled [Configuring Display of Video Statistics](#)). In real-time mode the video display statistics are shown. In Alarm, Archive, and Clip Search modes, it shows the time of the fragment being viewed and the playback mode:





Video statistic	Parameter description
Client-side FPS	Frame rate of the displayed video stream.
Server-side FPS	Frame rate of the video stream received from a video camera or an archive.
Bitrate	Bitrate of a compressed video stream.
Frame size	Resolution of the displayed video stream.

## Video Surveillance Mode Selection Tabs



To select the video surveillance mode, use the tabs in the lower right-hand part of the viewing tile.



Color coding of tabs corresponding to inactive surveillance modes is disabled:

1. Live Video mode  .
2. Archive mode:  .
3. Archive Search mode:  .

The tab corresponding to the active surveillance mode is highlighted with a color:

1. Live Video mode  .
2. Archive mode:  .
3. Archive Search mode:  .

Alarm Management mode is activated when an alarm is triggered.

## Information boards

Information boards offer a quick view of system status and events. There are three kinds of information boards, each displaying a specific type of information:

1. Events Board (1).
2. Health Board (2).
3. Statistics Board (3).

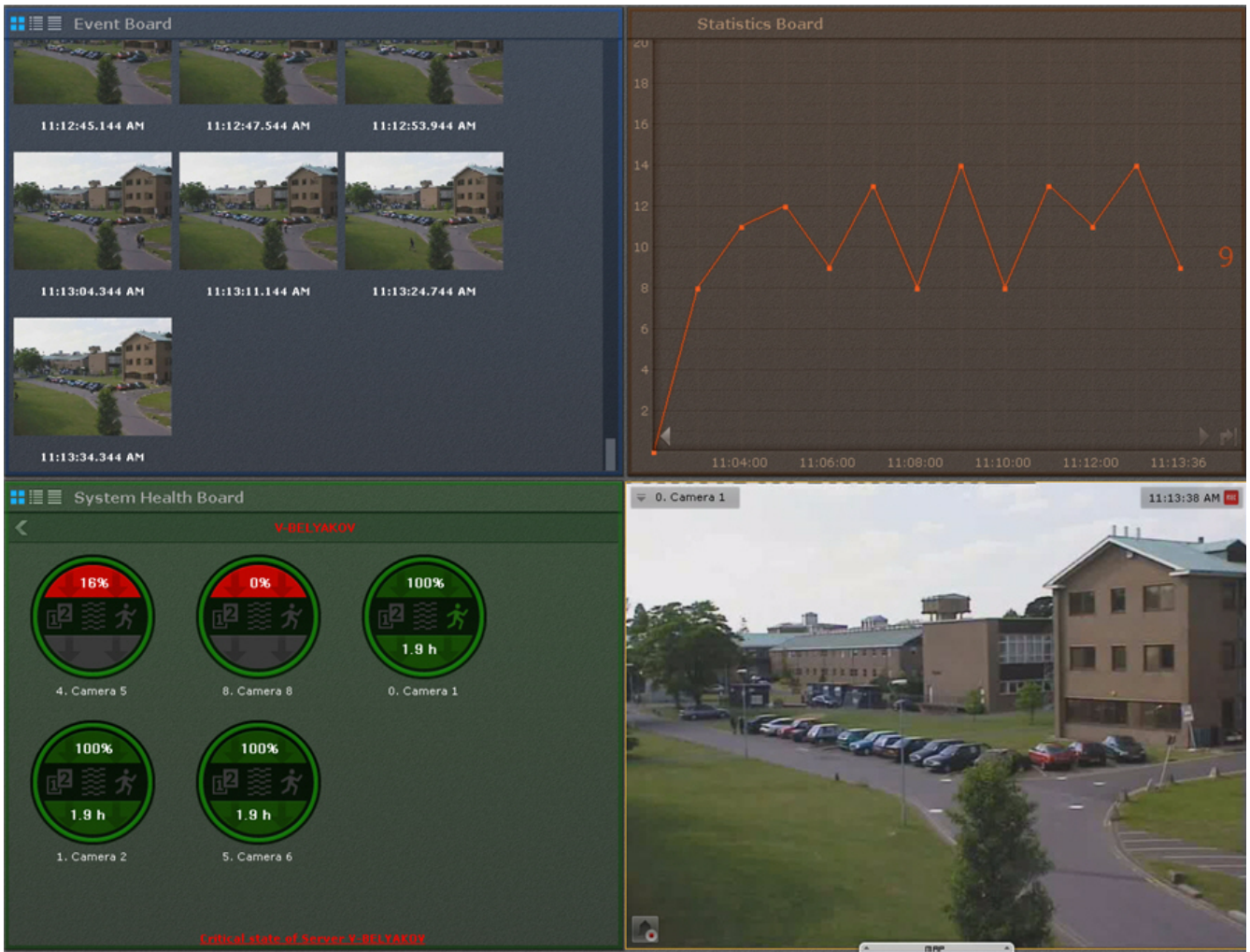

To learn about information boards, consult the relevant [section](#).

## Layouts

Layouts that have been created in the system are shown in the layouts ribbon.

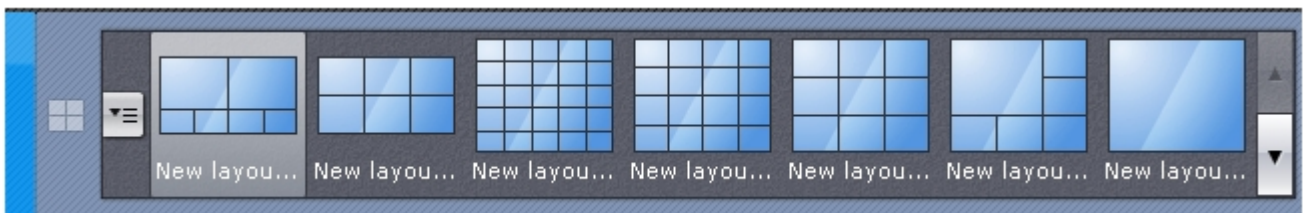

Operators of Axon Next can perform the following actions with layouts:

1. Select a layout for display on a monitor.
2. Start and stop slideshows of layouts.

### Select the displayed layout

To select a layout to display on a monitor, go to the layouts ribbon.

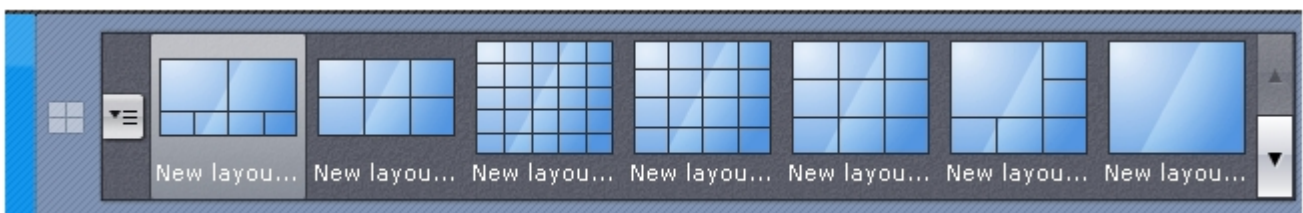

Left-click the appropriate thumbnail, after which the selected camera layout is displayed.

### Layout slideshow

Slideshow mode is rotation through all user-accessible layouts according to an assigned frequency (dwell-time).

To launch slideshow mode, bring up the context menu of the layout ribbon, click the  button, and select **Start slideshow**.

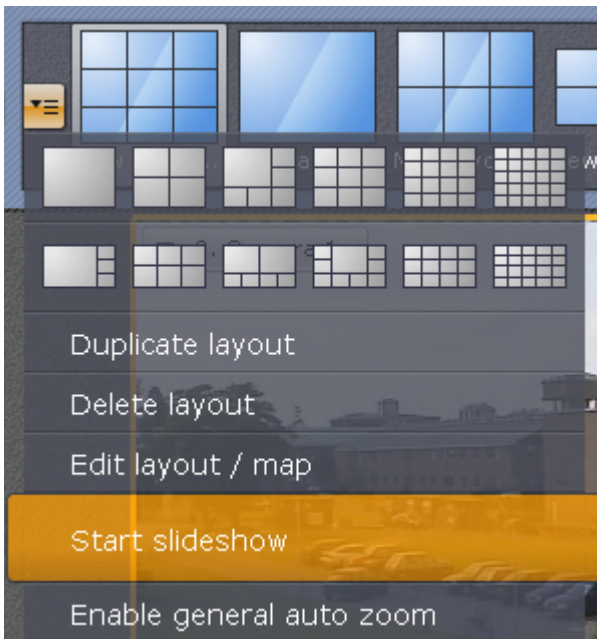

This will launch switching by rotation of all user-accessible layouts according to the assigned dwell-time.

To turn off slideshow mode, in the context menu of the layouts ribbon, select **Stop slideshow** or left-click any viewing tile.

## Interactive Map

The 3D interactive map is used to visualize the secured facility, control cameras and identify cameras' location.

Interactive maps in Axxon Next can obtain image data from graphics of the site or geospatial data from OpenStreetMap.

The map can contain icons for cameras, relays, and sensors. The area in which live video is displayed and field of view are indicated for each camera.

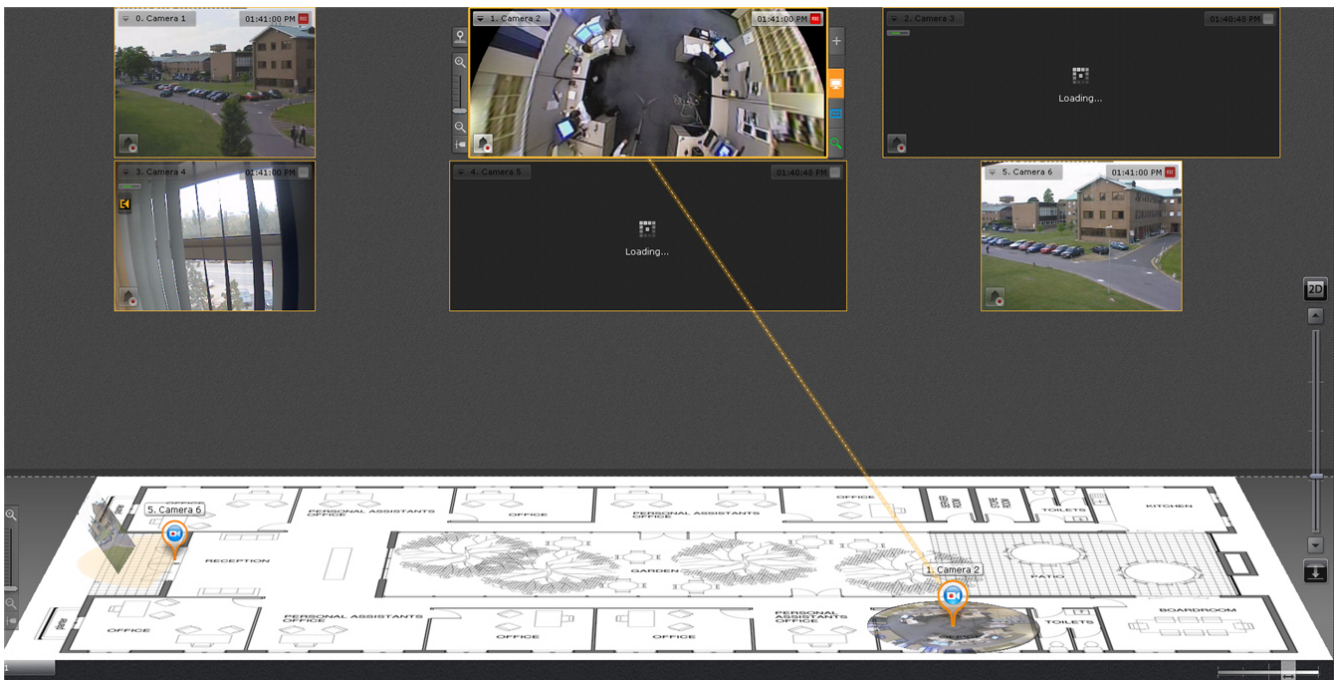

Please refer to the section titled [Working with the Interactive Map](#) for further details on how to work with the 3D map.

## Video camera panel

The video camera panel is used to display a list of video cameras linked to *Axxon Next*.

 **Note**

By default, the video cameras panel does not display any video cameras (**Not selected** status)

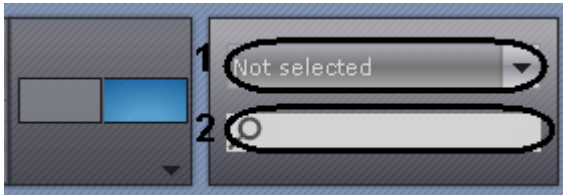

You can search for a camera either by:

1. Click the **Not selected** drop-down list (1) and select the necessary video camera group from the displayed list.

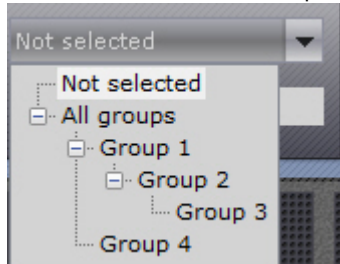

Once you have selected a group, the video camera panel will display only those video cameras that are included in the selected group.

2. Enter video camera's name or part of it into the search field (2).

The search starts automatically and all cameras with that name will be displayed in the **Video camera** panel.



**Note**

A video camera is displayed on the video camera panel only once. If you selected a group containing subgroups that all include a specific video camera, that video camera will be displayed on the video camera panel only once.

**Note**

If you selected a group containing subgroups, the video camera panel will display the video cameras included in that group as well as the cameras in all subgroups of that group.

When a video camera is clicked, a layout opens with the minimum number of cells for displaying the selected video camera.

**Note**

If the video camera is clicked in archive analysis mode, archive analysis is displayed for the selected video camera, but only if the camera is linked to the archive.

If there is no layout with the selected video camera, a new layout with a single cell is created.

## The Archive Navigation Panel

### The Structure and Function of the Archive Navigation Panel

The archive navigation panel is automatically displayed in the right-hand part of the screen when you switch the viewing tile to Archive or Search for Clip by Frame mode.

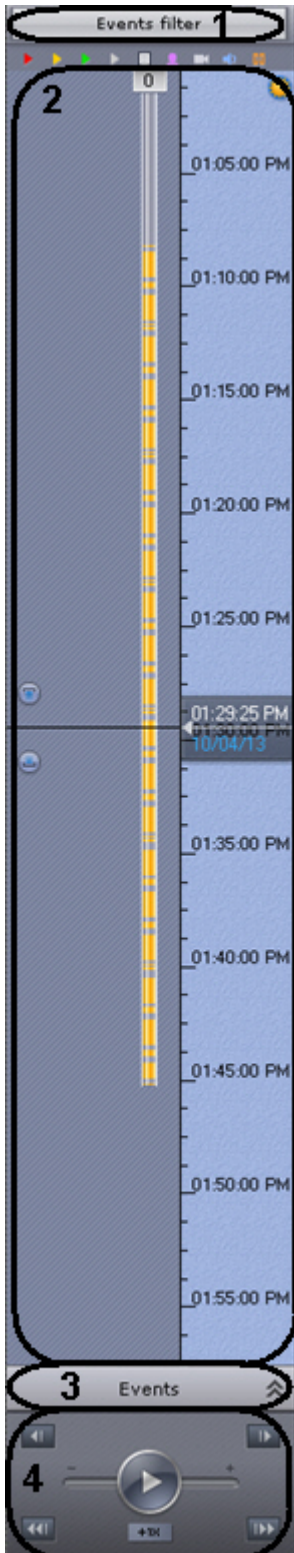

The archive navigation panel includes the following components:

1. The alarm events filter (1).
2. Timeline (2).
3. Events List (3).
4. Playback panel (4).

The archive navigation panel is used for the following functions:

1. Navigating through the archive.
2. Playing back recordings.
3. Selecting playback mode: forward or backward.
4. Setting playback speed.
5. Selecting events for display on the timeline and in the events list.
6. Viewing the list of events of the selected type.

## Events Filter

The **Events Filter** component allows selecting the type of events that are displayed on the archive navigation panel.

To select an event type:

1. Click the **Events filter** button (1). The **Events filter** window will then be displayed (2).

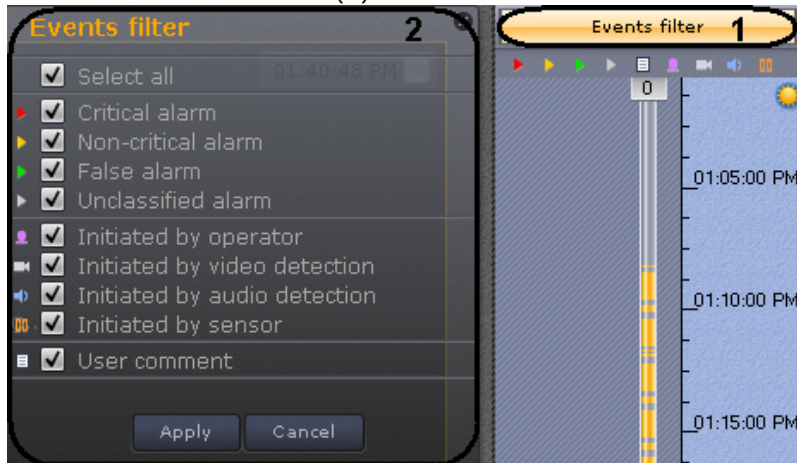

2. Select the check boxes for the types of alarms which should be displayed on the archive navigation panel, according to their status:
  - a. Critical alarm
  - b. Non-critical alarm
  - c. False alarm
  - d. Unclassified alarm

**Note.** If you clear the check box for a certain type of alarm, this type of alarm and the corresponding track are no longer displayed on the timeline

3. Select the check boxes for the types of alarms which should be displayed on the archive navigation panel, according to the cause of their initiation:
  - a. Initiated by operator
  - b. Initiated by video detection tool (basic, situation analysis, or embedded)
  - c. Initiated by audio detection tool (basic, situation analysis, or embedded)
  - d. Initiated by sensor

**Note.** By default, all check boxes are already selected.

**Attention** To display alarms on the timeline, select at least one type of alarm event and one initiator

4. Select the check box to display operator comments.
5. Click the **Apply** button.

**Note.** To close the window without saving changes, click **Cancel** or .

Selection of events is now complete.

Events of the selected type are now displayed on the timeline (see the section titled [The Timeline](#)) and in the events list (see the section titled [Events List](#)).

## The Timeline

The timeline is a graphical representation of the time axis of the archive and is located in the middle part of the navigation panel.

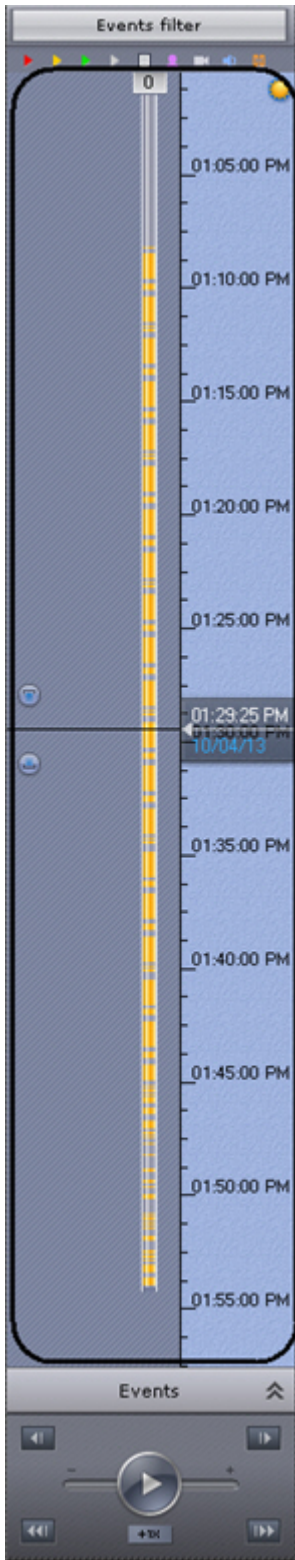

The timeline contains indicators of the presence of recordings, or tracks.

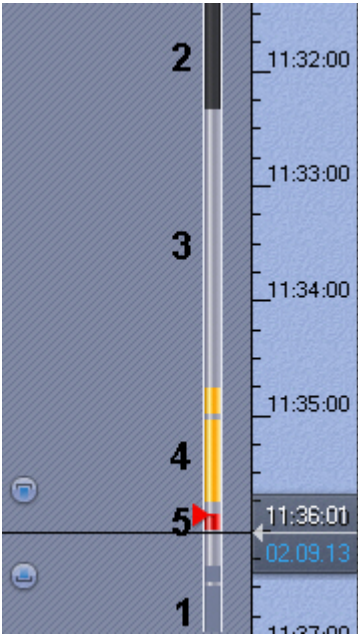

Tracks are marked in different colors depending on the alarm status or detection tool activation:

Condition	Track color
Archive absent (1)	Dark Gray
No signal from the video camera (2)	Black
Archive (3)	White
Archive present, detection tool activated (no alarm) (4)	Orange
Archive present, alarm active (5)	Red

**Note**

To display alarms on the timeline, select at least one type of alarm event and one initiator.

1. If tracks overlap on the timeline, they may replace each other. The priority of tracks is arranged as follows:
2. If there is recorded video, the track with the highest priority is red; the track with the lowest priority is white.

**Note**

The colors of alarm periods overlap when they coincide in time.

At the moment when an alarm is assigned a status (critical, non-critical, false, or unclassified), a flag is added to the track. A flag is added to the point on the timeline when the alarm began.

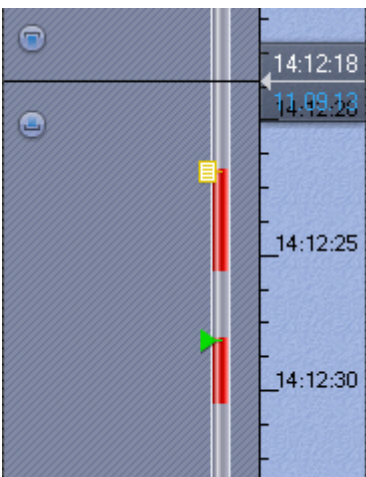

The flag is colored according to the alarm status:

1. Green – false alarm
2. Yellow – non-critical alarm
3. Red – critical alarm
4. Gray – unclassified alarm

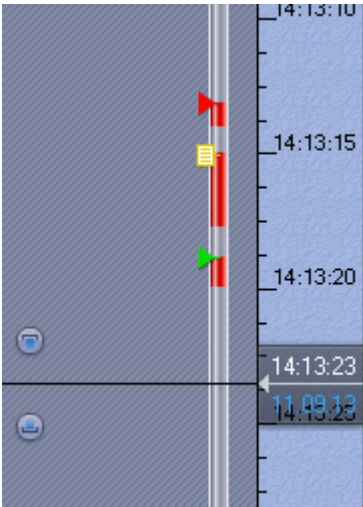

**Note**

Display of any particular alarm event in the list is determined by filter settings (see the section titled [Events Filter](#))

Operator comments are displayed with the corresponding icons on the track. An icon is placed on the timeline at the point corresponding to the commented frame (or to the first frame of the interval, if the comment is for an interval).

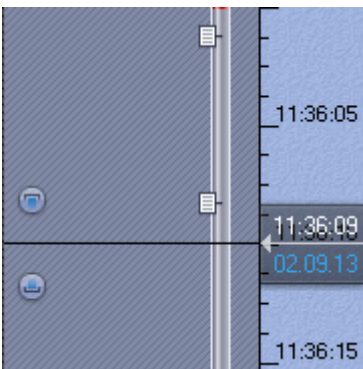

If comments were left during alarm classification, the icons are displayed in the appropriate colors.

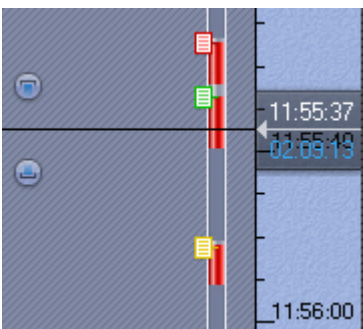

The timeline's background can be displayed in two styles, depending on settings (see the section titled [Configuring the timeline](#)):

1. **Day/Night**



**2. Shift work**

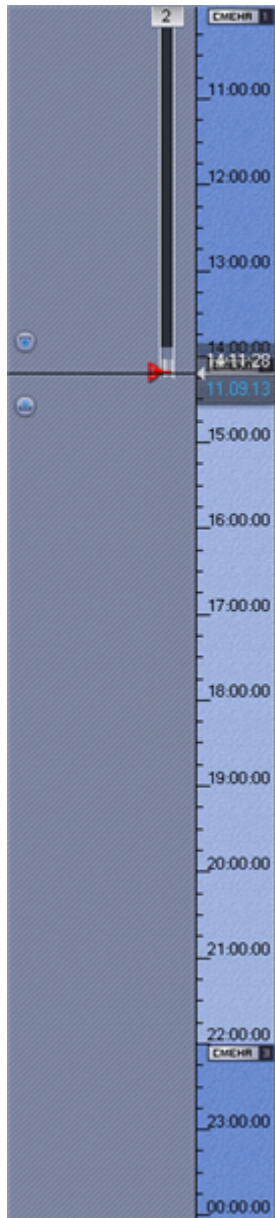

You can scroll and zoom the timeline using the mouse.

To scroll the timeline, move the cursor on its background (displayed in the **Day/Night** or **Shift work** style) vertically while holding down the left mouse button. To change the scale of the timeline, right-click the timeline's background (**Day/Night** or **Shift work**) and, while holding down the right mouse button, move the cursor down to zoom out or up to zoom in.

The timeline lets you select at which moment to start playback of a recording in the viewing tile. To choose at which moment to begin playback, you can either left-click the indicator and hold it down while dragging it to the desired position, or just left-click the left portion of the timeline.

If there is no recording in the selected position, the indicator will automatically move to the position corresponding to the nearest recording.

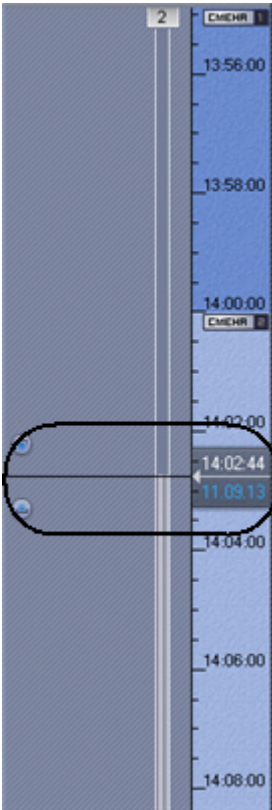

**Note**

You can also set a timeline indicator in the desired position by indicating the exact date and time (see the section titled [Navigating Using the Timeline](#)).

You can also position the timeline indicator with the help of the events list (see the section [Events List](#)).

## Events List

The Events List displays alarms and operator comments.

To display the events list, click the **Events** button.



The events list is now displayed.

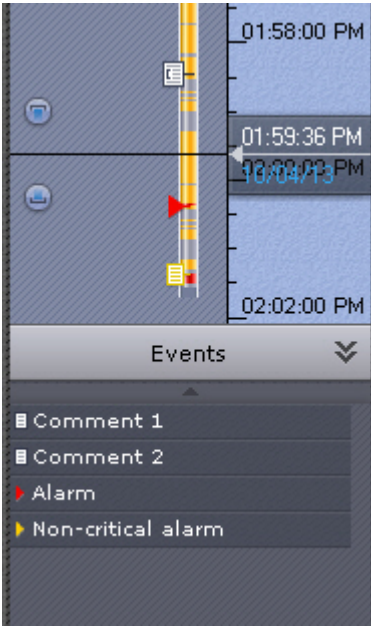

**Note** Whether or not a particular event is displayed in the list depends on the filter settings (see the section [Events Filter](#)).

**Note** The list displays only the alarm events that are currently in the visible portion of the timeline

To hide the events list, click the **Events** button again. When you place the cursor over an event in the list, detailed event information appears.

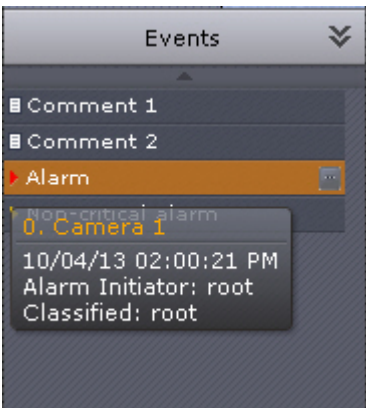



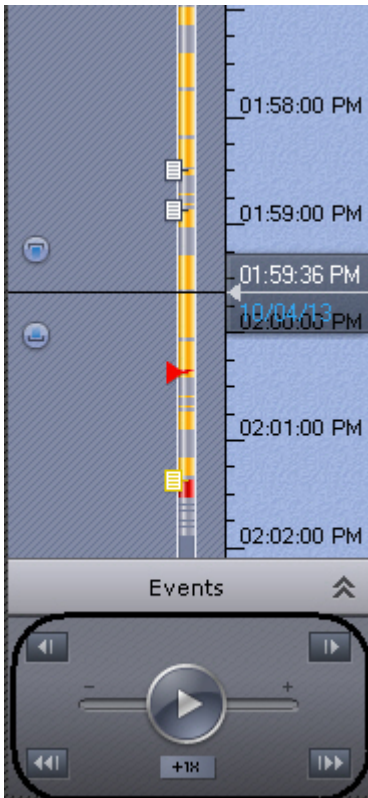

**Note** Navigation through the archive by using the events list is described in the section [Navigating Using the Events list](#)

## The Playback Panel

The playback panel is located in the lower part of the navigation panel.



The playback panel contains the following buttons:

1.  Go to preceding frame.
2.  Go to next frame.
3.  Switches to the preceding recording.
4.  Switches to the next recording.
5.  Play/Pause.

The  button also acts as a slider which sets the speed and mode (forward/backward) of playback.



**Note**

Use of the playback panel is described in detail in the section [Navigating Using the Playback Panel](#).

## Advanced archive navigation panel

The advanced archive navigation panel is automatically displayed in the lower portion of the viewing tile when you switch to Archive mode or Archive Search mode.



The advanced archive navigation panel includes the following components:

1. Timeline
2. Playback control buttons
3. Tabs for compressed and standard archive playback modes

The advanced archive navigation panel is used to position the archive at a specific time, control playback, and switch to compressed archive playback mode.

The timeline on the advanced archive navigation panel features archive tags . This tag stands for a lack of archive in a compressed format. The time period for which there is no archive is indicated near the tag.

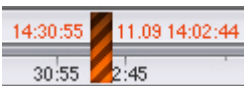

The advanced archive navigation panel works completely in sync with the playback panel and the timeline:

1. The playback mode selected on the advanced navigation panel is displayed on the playback panel.
2. The playback speed that is set on the playback panel will be used as the playback speed when playback is restarted on the advanced navigation panel, and vice versa.
3. The playback control buttons on the advanced navigation panel are the same as the buttons on the playback panel.
4. Any movement through the main timeline is duplicated onto the timeline of the advanced navigation panel.

## The PTZ Control Panel

The PTZ control panel is displayed automatically in the right-hand part of the screen when the viewing tile of a PTZ camera is activated in Live Video mode.



### Note

The PTZ control panel is displayed only if the **Telemetry** object for the particular video camera is enabled (see the section titled [The Telemetry Object](#)).



The PTZ control panel is used for the following functions:

1. Controlling PTZ video cameras.
2. Setting and switching to camera presets.
3. Launching/stopping patrolling.

The PTZ control panel includes the following interface elements:

1. Presets list
2. Dialer
3. PTZ controls for iris, focus, and optical zoom



**Note**

If a camera does not support a function, the controls for this function cannot be accessed

4. Virtual 3D joystick



**Note**

The type of virtual 3D joystick and adjustment scale depend on the type of PTZ cameras: discrete or continuous control of Pan, Tilt, Zoom, Focus, and Iris.



5. Patrol button



**Note**

Use of the dialer, PTZ controls, joystick, and patrol button is described in the section [Controlling a PTZ Camera](#).

## The Enter number Panel

The Enter number panel is used to switch to a PTZ preset.

To display the Enter number panel, click the **Enter number** button. The Enter number panel will then be displayed on the PTZ control panel.

The Enter number button:



The Enter number panel:

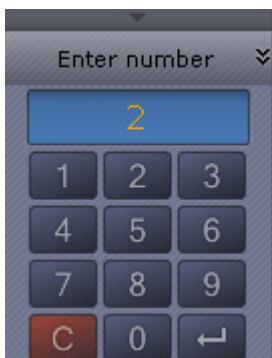

To hide the Enter number panel, click the **Enter number** button again.

Switching to a PTZ preset using the Enter number panel is described in detail in the section titled [Control Using the Enter number Panel](#)

## The Presets List

The presets list created for a selected video camera is displayed in the upper part of the PTZ control panel.

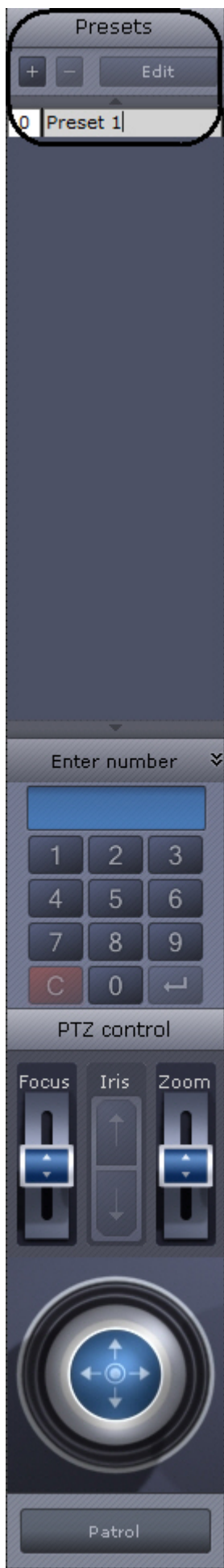

For each preset in the list, the following parameters are displayed:

1. The identification number
2. A descriptive name

The presets list is used for the following functions:

1. Creating presets.
2. Editing the identification number and name of an existing preset.
3. Deleting presets.
4. Switching to a preset.

You can create up to 100 presets with numbers from 0 to 99. To create a preset, you must perform the following steps:

1. Place the PTZ camera in the position which is to be saved as a preset.
2. Click . Fields for entering an identification number and a descriptive name for the preset will then appear.



3. Fill in these fields as desired.



**Attention!**

If a preset with the identification number entered already exists, its parameters, as well as the corresponding PTZ camera position, will be overwritten.

4. Left-click anywhere in the presets list and press Enter to save changes.

Creation of a preset is now complete.

To edit the number and name of an existing preset, you must perform the following steps:

1. Highlight the desired preset in the list.
2. Click . The identification number and descriptive name fields will then become accessible for editing.
3. Modify the preset number and/or name as desired.
4. Left-click anywhere in the presets list to save changes.

Editing of the preset is now complete.

To delete an existing preset, you must perform the following steps:

1. Highlight the desired preset in the list.
2. Click .

The preset has now been deleted.

To switch to a preset, left-click the corresponding line in the presets list. The camera will then be switched to the desired position.



**Note**

See the section [Control Using the Presets List](#).

## Video Surveillance

### Video Surveillance Modes

The video image from a video camera is displayed on the computer monitor through the Client's interface objects, namely the video surveillance monitor and the viewing tile.

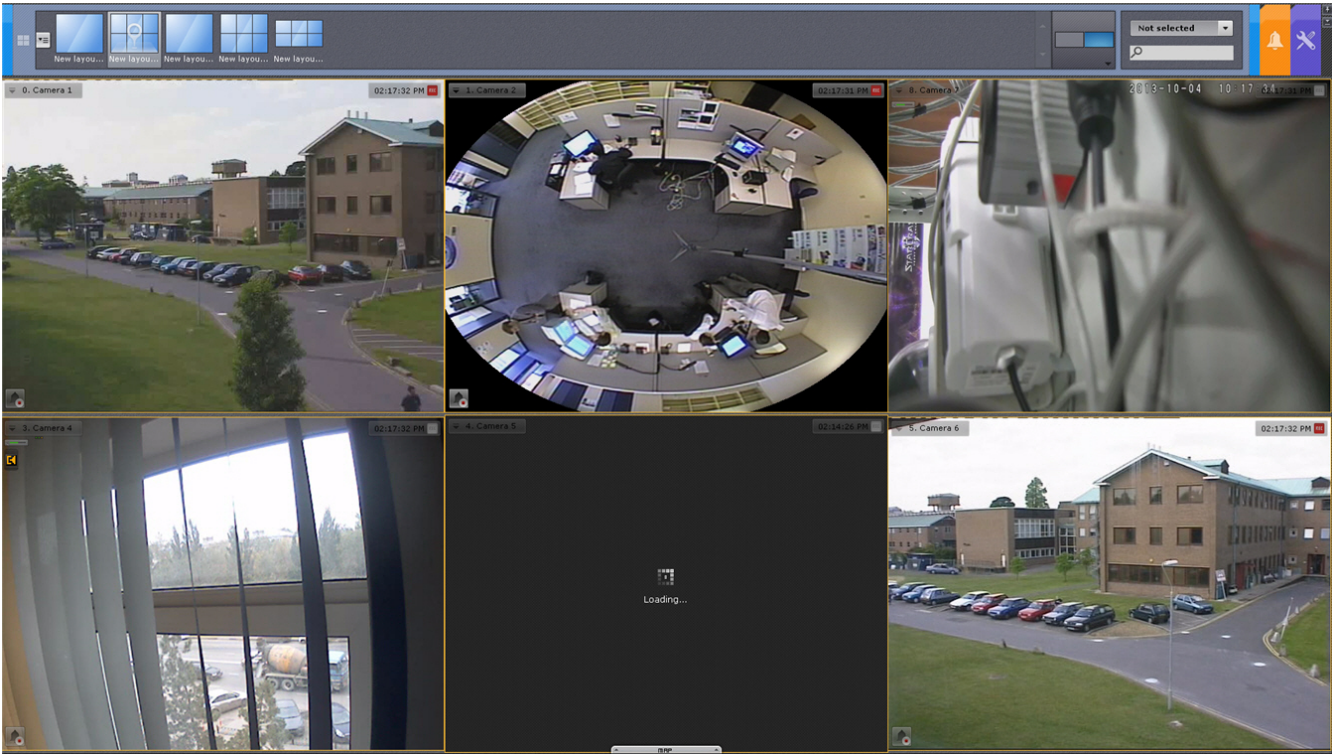

There are three modes for working with a viewing tile:

1. Live Video mode
2. Alarm Management mode
3. Archive mode
4. Archive Search mode



**Note**

Alarm Management mode is available if an alarm has been initiated in the system.

[Play corresponding video](#)

## Functions Available in All Video Surveillance Modes

The following video surveillance functions are available in all video surveillance modes:

1. Selecting a video camera.
2. Scaling the viewing tile.
3. Digitally zooming video images.
4. Processing video images.
5. Tracking objects.
6. Operator comments.

### Selecting a video camera

Support for camera selection allows selecting a necessary camera in any viewing tile in a layout. Any changes to the layout are not saved when switching to another layout.



**Attention!**

In the archive and alarm management modes, clicking an event will switch the view to the live video mode.

To select a video camera using the context menu of the viewing tile, you must perform the following steps:

1. Bring up the context menu in the viewing tile **(1)**.
2. Choose **Select camera (2)**.



3. Select the necessary video camera in the displayed list using one of the following methods:
  - a. If the necessary video camera is included in a group, you must first select the group (the group may also contain subgroups), then select the video camera.
  - b. If the necessary video camera is not included in one of the groups, you must select the list of all video cameras that follows the list of groups.





The image from the selected video camera will now be displayed in the viewing tile.

## Scaling the Viewing Tile

The scale of the viewing tile can be adjusted. You can do this by using the buttons in the upper right-hand part of the active viewing tile:



1.  — increases the size of the viewing tile by one step;

2.  — decreases the size of the viewing tile by one step.

When a viewing tile is enlarged, the scale of the entire layout is increased. Some of the cells are moved off the screen.

Viewing tiles are enlarged as follows:

1. If a viewing tile occupies 100% of any of the sides of the layout (maximum viewing tile size), it cannot be enlarged.
2. If a viewing tile occupies 50% or more (but not 100%) of any of the sides of the layout, it is enlarged as much as possible.
3. If a viewing tile occupies less than 50% on both sides of the layout, it is enlarged in two steps: the first step enlarges the viewing tile to 50% on the corresponding side of the layout and the second step enlarges the viewing tile to the maximum size.

 **Note**  
The third case applies to layouts that contain nine or more cells

The size of viewing tiles is reduced in a similar manner.

If a viewing tile is linked to an information board, at the first enlargement step (to 50%), the viewing tile and information board are displayed together and occupy all of the screen on one side.

 **Note**  
In this case, the first step takes into account the total size of the related cells: the related cells must be less than 50% of both sides of the layout

You can also use the mouse to scale the viewing tile. If the viewing tile is maximized to fill the entire screen, a double left-click of your mouse within the tile area will minimize the tile. Otherwise a double left-click will maximize the viewing tile to fill the entire screen.

## Digitally Zooming Video Images

Digital zooming in a video image enables a gradual increase in the magnification of a video image without changing the dimensions of the viewing tile.

The video image can be enlarged using the following tools:

1. Digital zoom scale
2. Area selection
3. Mouse scroll wheel

### Enlarging a video image using the digital zoom scale

To display the digital zoom scale on the viewing tile screen, select **Show digital zoom** in the context menu of the viewing tile.

Displaying the zoom control:

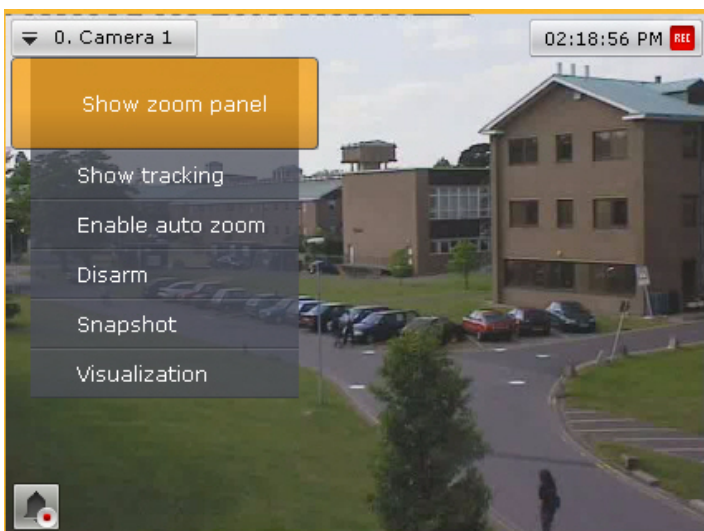

Digital zoom scale:



To enlarge a video image, left-click the slider and hold and drag the digital zoom scale up to the desired value. The maximum zoom is 16X. To return back to the original image, move the slider back to its original position.

**Note**

You can also use the  and  buttons to scale the video image.

To hide the digital zoom scale, select **Hide digital zoom** in the context menu of the viewing tile.

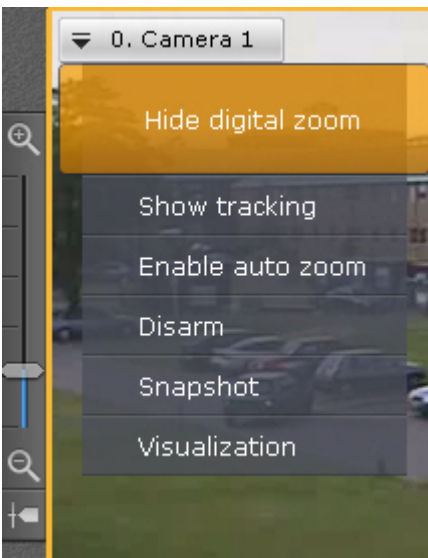

**Note**

If the slider remains on a single digital zoom value for more than 5 seconds, the zoom scale will be automatically hidden.

After hiding the digital zoom scale, the selected zoom level of the image will be preserved when switching between image viewing modes.

### Enlarging a video image through area selection

To enlarge a video image, select the area of the image that you would like to enlarge.

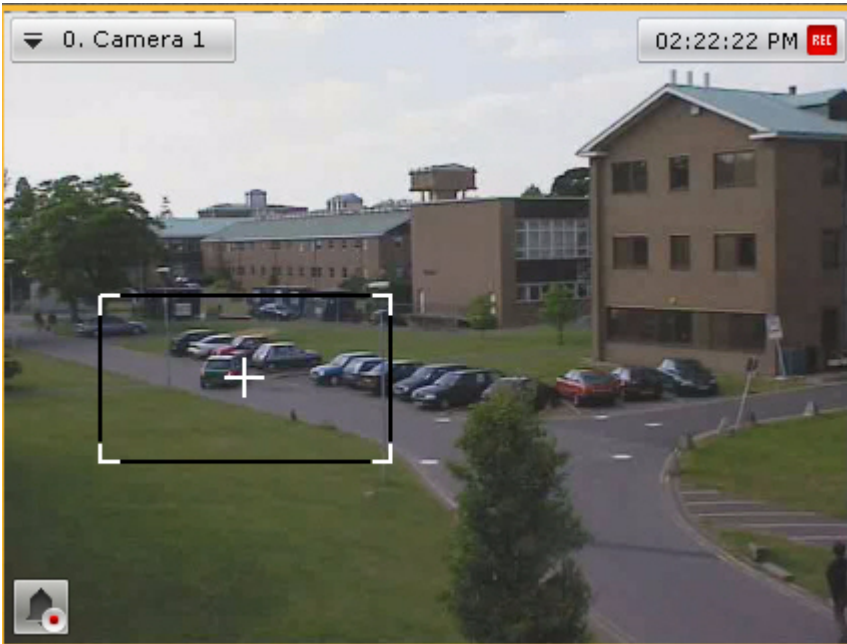

You can select an area by doing the following:

1. Click and hold down the left mouse button inside the viewing tile.
2. Move the mouse cursor to the desired position.
3. Release the left mouse button.

Once you have completed the above actions, the selected area will be displayed across the entire viewing tile.



**Note**

If you select an area that requires a zoom of more than 16x to display, it will be marked with a red frame. The video image will not be enlarged.



## Enlarging a video image using the mouse scroll wheel

When using the mouse scroll wheel, the video image is enlarged relative to the mouse cursor. A description of this process is provided in the table below.

Action	Executed function
Mouse wheel is scrolled forward by one level	The video image is enlarged by 2x
Mouse wheel is scrolled backward by one level	The video image is reduced by 2x

## Video image processing

In *Axxon Next*, the video image processing functions implemented in the viewing tile enhance the performance and convenience of using the video surveillance system.

The following video image processing functions are available from the viewing tile:

1. Contrast
2. Sharpness
3. Deinterlacing

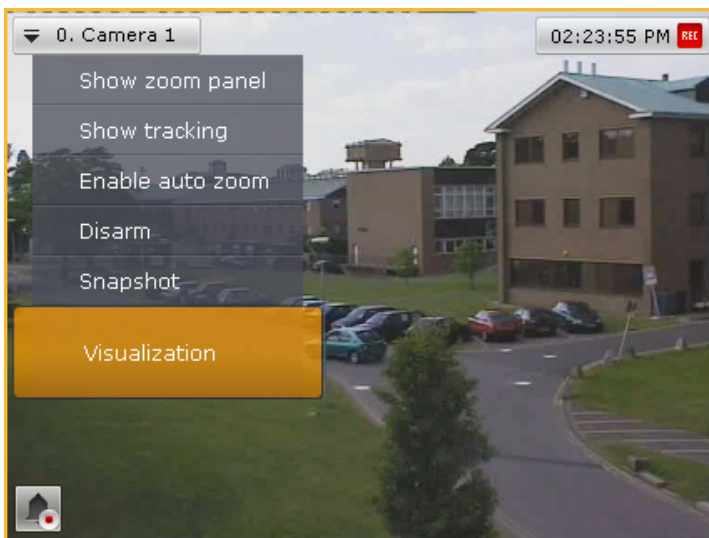

To enable video image processing functions, use the **Visualization** option in the context menu of the viewing tile. Only one image processing function can be enabled at a time.

### Changing the Contrast Level

An *Axxon Next* operator is granted access to adjust the contrast of a video image.

To adjust the contrast, select the **Contrast** option in the **Visualization** context menu.

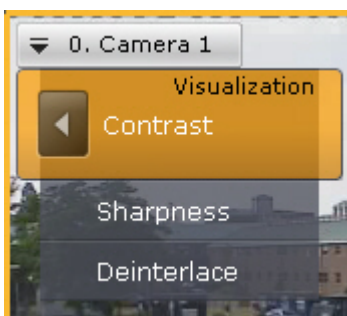

An example of the **Contrast** function is given in the following image.

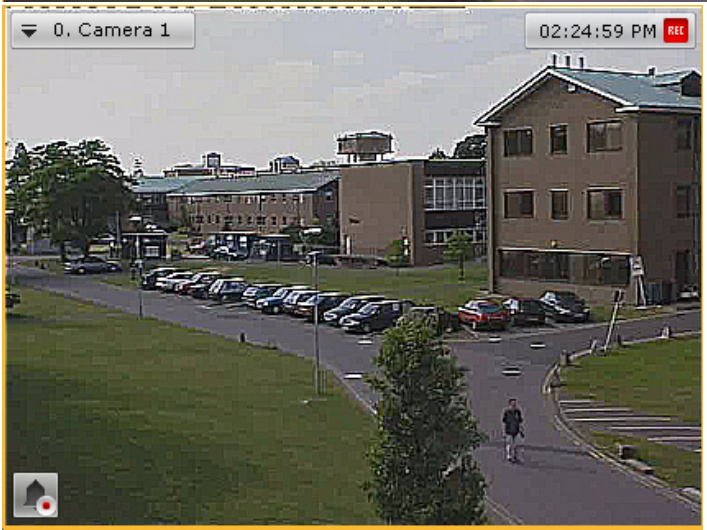

To return to the original image, reselect the **Contrast** option in the **Visualization** context menu.

### Setting the Sharpness Level

An Axxon Next operator is granted access to adjust the sharpness of a video image.

To adjust the sharpness, select the **Sharpness** option in the **Visualization** context menu.

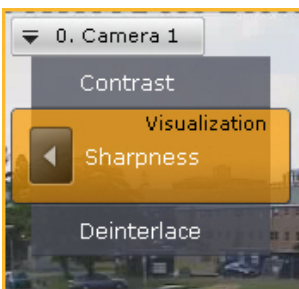

The image in the following picture shows an example of use of the **Sharpness** tool.



To return to the original image, use the **Sharpness** function again.

### Using Deinterlacing

The **Deinterlacing** tool is used to correct tooth-type distortions (also called "combing artifacts"), which appear on the borders of video image fragments when objects move quickly relative to the background.

An example of a combing artifact is shown in the picture below.



To utilize this tool, select the **Deinterlacing** option in the **Visualization** context menu.

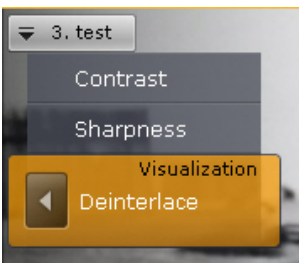

The image in the viewing tile will then be corrected.



To disable **Deinterlacing**, reselect the **Deinterlacing** option.

## Tracking objects

Object tracking allows a user to visually track the movement of objects in a camera's field of view or in a video recording in an archive.



### Attention!

Object tracking is possible only if a situation analysis detection unit and/or an embedded detection unit is active (see the sections [Situation Analysis Detection Tools](#) and [Embedded Analytics](#)).

Object tracking performs the following functions:

1. Recognizes the presence of a moving object and dynamically marks it with a transparent rectangle on the video image.
2. Displays the trajectory of the object's movement.

Motion is detected based on the time gradient of the video image's difference between frames.

To enable object tracking, select **Show tracking** in the viewing tile context menu.

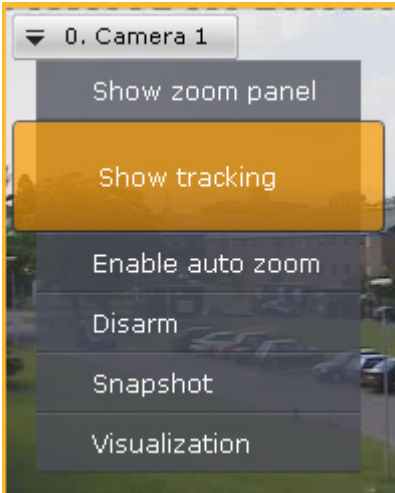

Object tracking functions will now be activated.



To disable object tracking, click **Hide tracking** in the viewing tile context menu..

## Operator comments

Operator comments on past or ongoing events allow a more complete understanding about the situation at the site.

Comments are displayed during playback (see [Viewing recorded video with operator comments](#)) and are marked with tags on the timeline (see [The Timeline](#)). Comments can also be searched (see [Searching comments](#)).

### Adding comments in different surveillance modes

In Live Video mode, comments can be added only if the video is "frozen" (see [Using the Snapshot function](#)) and the video camera is linked to an archive.

If these conditions are met, the upper-right corner of the viewing tile displays a time indicator and adjacent to it an  button, which is used to add comments.

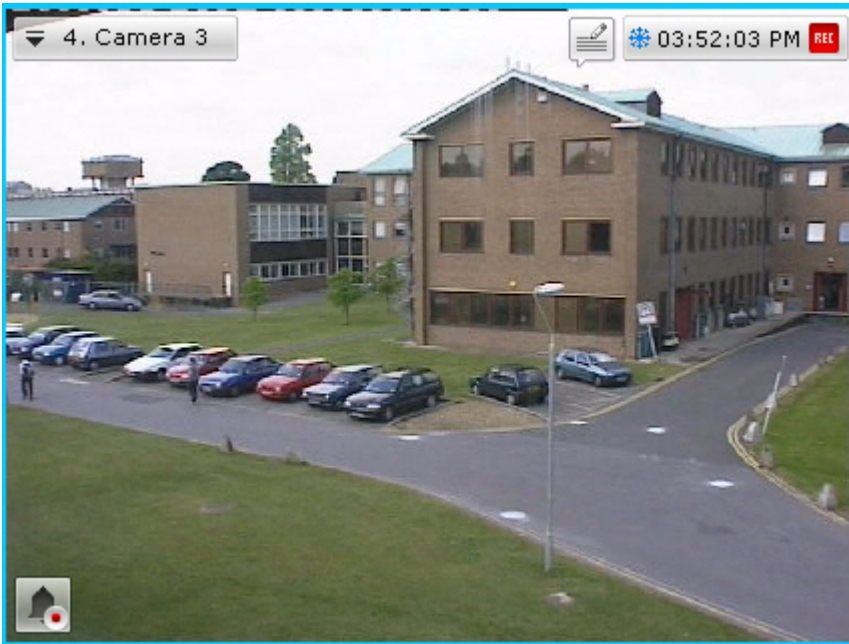

**Note**  
 If the video camera is linked to an archive but recording is not currently underway, when the video is "frozen" recording to the archive is turned on for 10 seconds.

In Archive and Archive Analysis modes, comments can be added both for specific frames and for intervals of time. To add a comment for an interval, select an interval on the timeline, place the timeline indicator either inside the interval or at one border of it, and click the  button.

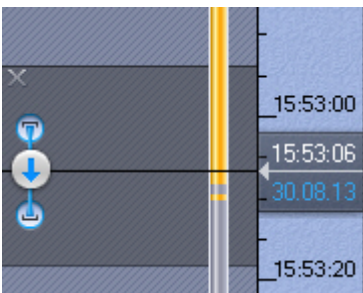

**Note**  
 If comments are added during playback in Archive or Archive Analysis mode, playback is paused after the  button is clicked.

In Alarm Management mode, operators can be required to give comments after classifying an event (see [Configuring Alarm Management Mode](#)) or comments can be left in free form, before event classification, by clicking the  button. The comment applies to the entire duration of the alarm.



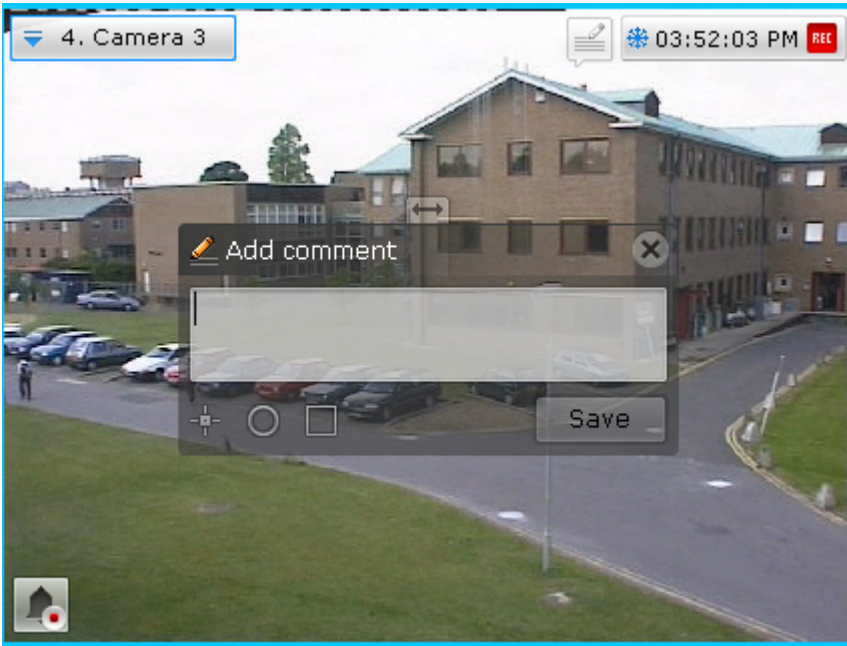

### Adding a comment

To add a comment, click the  button. A dialog box opens for entering a comment.



The number of characters in the comment is limited.

The following parameters can be configured:

1. Position of comment in the frame (the window with the comment is movable by dragging the window title).
2. Transparency of comment window, by adjusting the  slider from left to right (from opaque to maximum transparency).
3. Marking the area of interest in the frame, with a dot () , semicircle () , or rectangle (). To do so:
  - a. Click the relevant button and then click anywhere in the frame. The selected element is displayed.



- b. Drag the element to the necessary place in the frame. To do so, left-click and drag the edge of the area (or for a dot, click and drag the dot).
- c. Set the size by dragging the corner points.

To save the comment, click the **Save** button. Otherwise, click  to cancel.

After being saved, a comment is displayed in the frame as specified. To delete the comment, before you perform any other command in the system, click the  button..

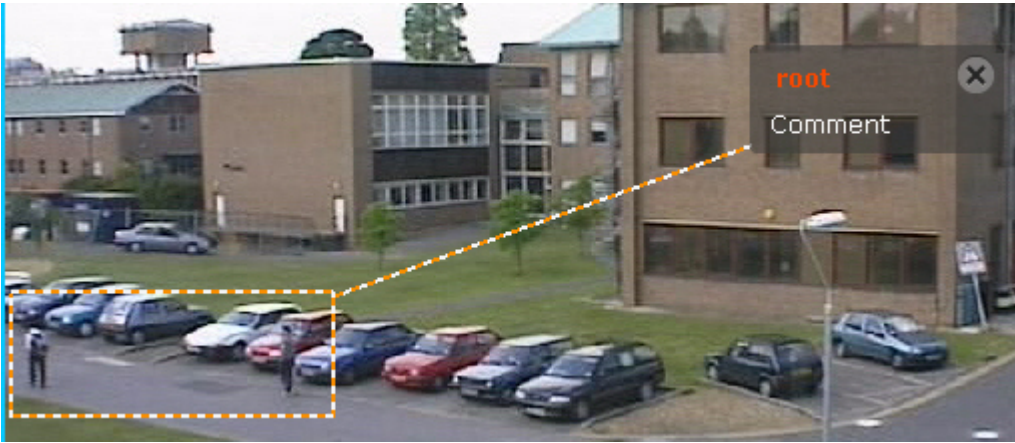

## Real-time video surveillance

### Switching to Live Video Mode



To switch the viewing tile from a different surveillance mode to archive analysis mode, switch to the  tab in the lower-right corner of the tile.



The viewing tile will then appear in Live Video mode.



## Video Surveillance Functions Available in Live Video Mode

In Live Video mode, the following video surveillance functions are accessible:

1. Selecting a video camera.
2. Scaling the viewing tile.
3. Digitally zooming video images.
4. Selecting video stream quality in a viewing tile.
5. Tracking objects.
6. Autozoom.
7. Processing video images.
8. Arming/disarming a video camera.
9. Taking snapshots.
10. Controlling a PTZ Camera.
11. Controlling relays.
12. Displaying the sensor status.
13. Viewing the results of a saved search query.



### Note

The following functions are accessible in all video surveillance modes: selecting a video camera, scaling of viewing tiles, digital zoom, and video image processing. A description of these functions is provided in the section titled [Functions Available in All Video Surveillance Modes](#)

## Arming and Disarming a Video Camera

In *Axxon Next*, a video camera is armed via all the detection tools registered for that video camera.

To arm a camera, select **Arm** in the context menu of the viewing tile. If the video camera is in armed mode.

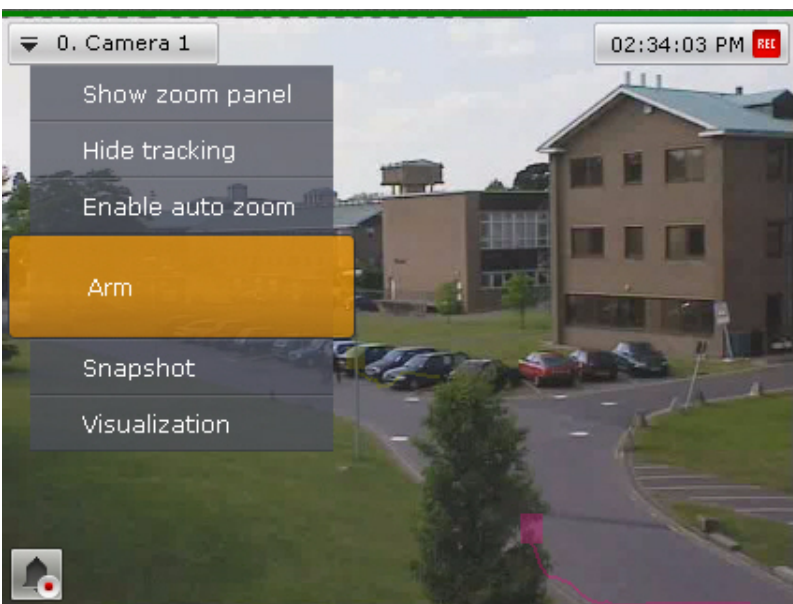

To disarm a camera , select **Disarm** in the context menu of the viewing tile. The video camera will then be disarmed.

## Using the Snapshot function

An Axxon Next operator is granted access to the **Snapshot** function.

Activation of the **Snapshot** function pauses the video image displayed at the moment the function is activated. However, this does not stop the video playback process, and when this function is turned off, the user will see the video image corresponding to the current time.

To turn on the **Snapshot** function, select the **Snapshot** option in the context menu of the viewing tile or left-click the Time field (see the [Time Display](#) section).

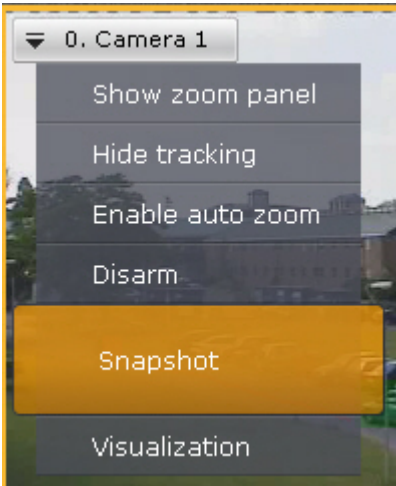

This will cause the viewing tile to be highlighted with a blue border. A **snowflake** icon will appear in the Time field, and the **Snapshot** option will be replaced with **Cancel snapshot** in the context menu of the viewing tile.

An example of using the Snapshot function Snowflake symbol:

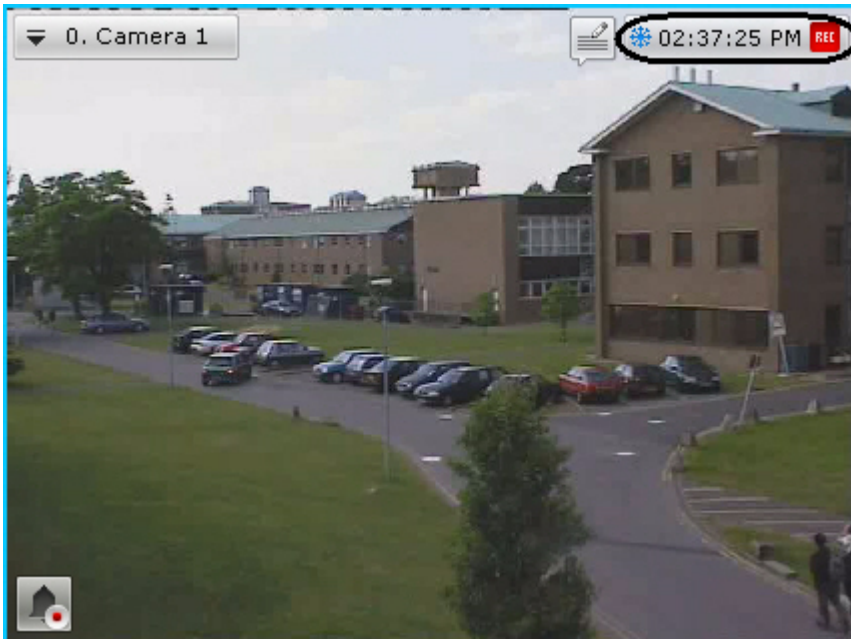

An example of using the Snapshot function Cancel snapshot option Snapshot:

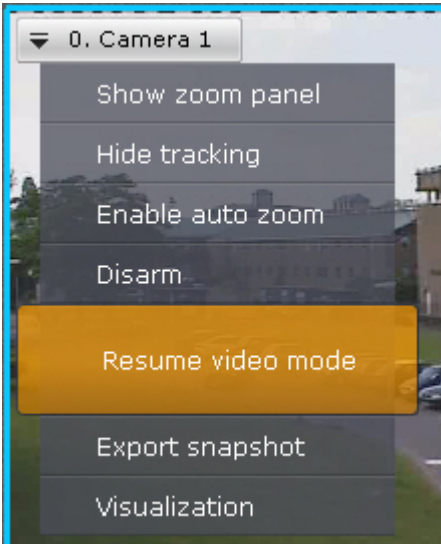

To save the snapshot, select the **Export snapshot** option in the context menu of the video camera (see the section [Frame export](#)).

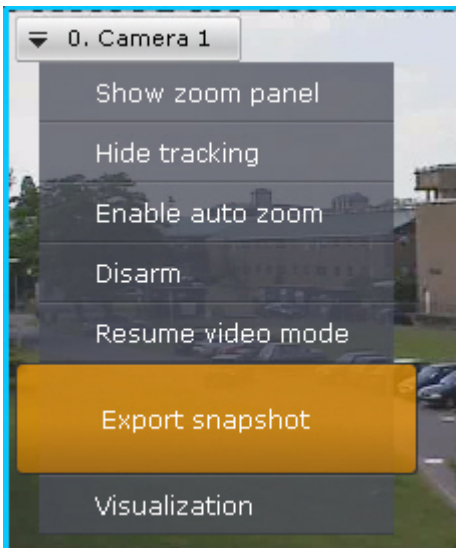

**Note**  
Snapshots are automatically exported if the corresponding function is enabled in the settings (see [Configuring export](#)).

To turn off the **Snapshot** function, select the **Resume video mode** option in the context menu of the viewing tile or click the time indicator again (see the section titled [Time Display](#)).

## Controlling a PTZ Camera

A PTZ video camera is controlled through the PTZ device control panel.

**Note**  
You can use your mouse to change a camera lens' focus (see the section titled [Changing the camera lens focus \(Point&Click\)](#)).

The user gains access to this panel when the viewing tile of a video camera in Live Video mode that supports a PTZ control interface is selected.

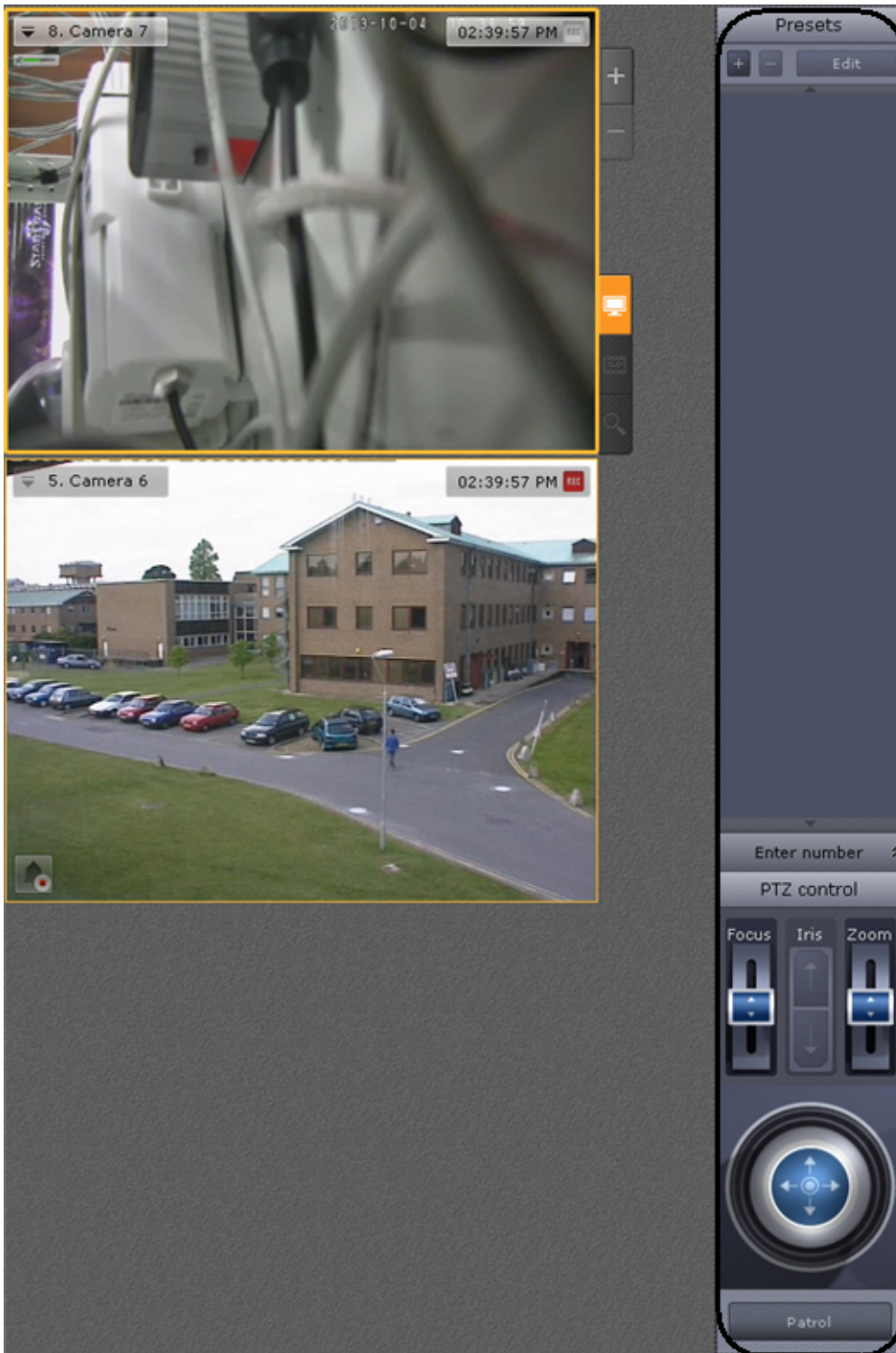

The following actions can be performed using the PTZ device control panel:

1. Use presets.
2. Modify the parameters of the iris, focus, and optical zoom.
3. Modify the horizontal and vertical tilt angle of the video camera.
4. Starting/stopping patrol mode.



**Note**

Setting presets is described in detail in the section [The PTZ Control Panel](#).

### Control Using the Presets List

To switch a PTZ camera to a preset, you can use the presets list. To do this, left-click the corresponding line in the given presets list.



## Control Using the Enter number Panel

To switch a PTZ camera to a preset, you can use the Enter number panel. To display the Enter number panel, click the **Enter number** button.



To switch to a preset using the Enter number panel, you must perform the following steps:

1. Using the numeric buttons (0-9), enter the number of the preset to which you want to switch. The entered number is displayed in a special field.

To delete the last digit entered, click the  button.



2. Click the  button to switch to the preset with the number entered. The camera will then be switched to the desired position.

Switching to a preset using the Enter number panel is now complete.



### Note

Examples of entering a number:

**5,**  – Switch to preset number 5;

**0, 5,**  – Switch to preset number 5.

**5, 7,**  – Switch to preset number 57.

## Control Using a Virtual Joystick

A PTZ video camera can be controlled with a virtual joystick through the PTZ device control panel.

The virtual joystick is shown in the following figure.



**Note**

If the video camera cannot be controlled by a virtual joystick, intuitive buttons for PTZ control are displayed instead



Virtual joysticks are controlled as follows:

1. Click and hold down the left mouse button in the central (blue) portion of the joystick.
2. Drag the joystick in the necessary direction.

**Note**

You can also move the joystick by clicking and holding the left mouse button outside of the joystick border.

The turn speed depends on the tilt of the joystick: the greater the tilt, the higher the speed.

### Patrolling

Patrolling is an automatic change in the position of a camera along a route defined in the camera's presets list. Patrolling is enabled through the **Patrol** button in the PTZ camera control panel.



To stop patrolling, click the **Patrol** button again.

**Attention!**

Manual control takes priority over automatic control. Any interference in the patrolling process cancels it.

### Control using Point&Click

To change the focus of the camera lens, left-click anywhere within the video image in the viewing tile.

Once you have done that, the focus of the camera lens will automatically change to the selected area. The focus is changed using *Axxon Next* algorithms.

**Note**

This function is available for only some CCTV cameras.

For more information, contact AxxonSoft.

### Control using Areazoom

You can focus on a particular area in a video frame.

To do so:

1. Click a point to focus on it.



2. Holding down the mouse button, moving outward from the center of the focus area, the user sets the size of the area. Releasing the mouse button finalizes the selection.



The lens is reoriented and the image is enlarged so that the selected area now fills the entire viewing tile.

**Note**  
This function is available for only some CCTV cameras.  
For more information, contact AxxonSoft.

## Managing Relays

To control a relay, select **Show relay** in the context menu of the viewing title.

**Note**  
You must first activate an object before you can control its relay.



The relay control button will now be displayed.

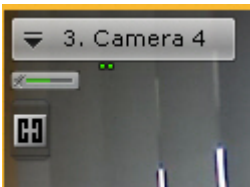

**Note**  
To hide the relay control button, select **Hide relay** in the context menu of the viewing tile.

When the relay control button is clicked, the relay shifts from one status to the other.

**Note**  
If a relay is controlled by several operators simultaneously, the relay will remain activated as long as at least one operator requires it.

Button status	Button image	Relay status
Not clicked		Normal
Clicked		Activated

## Displaying the sensor status

To display the status of a video camera's sensor, select **Show sensor** in the context menu of the viewing tile.

**Note**  
You must first activate an object to display the status of its sensor.

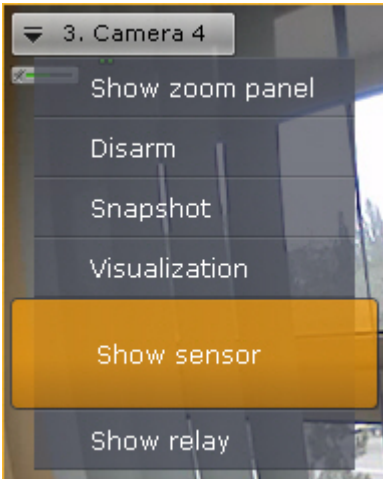

The status of the sensor will now appear in the viewing tile.



**Note**

To hide the sensor status, select **Hide sensor** in the context menu of the viewing tile.

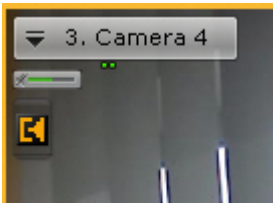

There are four possible statuses of a sensor.

Sensor status	Description
	Video camera is armed, sensor is in normal status
	Video camera is armed, sensor is in alarm status
	Video camera is disarmed, sensor is in normal status
	Video camera is disarmed, sensor is in alarm status

### Selecting video stream quality in a viewing tile

If a video camera supports multistreaming, you can select the quality of the video stream that you want for display in viewing tiles.



**Note**

If the video camera is not configured for multiple video streams, this action is not available (see [The Video Camera Object](#)).

To select video stream quality:

1. In the context menu of the viewing tile, select **Select quality**.

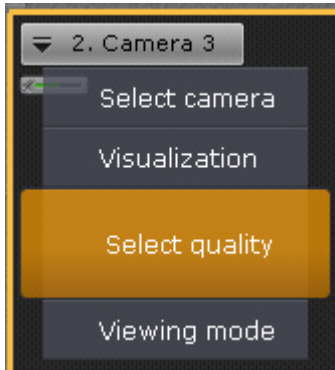

2. Select the quality of video stream that you want for display in the viewing tile.



Context menu item	Description
Auto	A video stream will be chosen automatically depending on the size of the viewing tile (with account of digital image zoom)
High	A high-quality video stream is used for display in the viewing tile (see <a href="#">The Video Camera Object</a> ).
Low	A low-quality video stream is used for display in the viewing tile (see <a href="#">The Video Camera Object</a> ).

**Note**  
Automatic video stream selection (enabled by the **Auto** option) is unavailable if automatic resolution selection has been set for any stream (see [The Video Camera Object](#)).

Selection of video stream quality in the viewing tile is now complete.

## Autozoom

The **Autozoom** function performs automatic control of digital zoom.

If a viewing tile is inactive and autozoom is enabled, the following actions occur:

1. The smallest rectangular area that contains all tracked objects (even if object tracking is disabled) is chosen.
2. Maximum digital zoom is performed for the selected area.

If autozoom is enabled but there are no moving objects in the video frame, the contents of the viewing tile are shown at their original size.

**Note**  
If the Fit screen function is activated for a viewing tile, the default digital zoom level is used.

Autozoom stops when a viewing tile is selected and resumes when the viewing tile is no longer active.

Autozoom can be enabled both for a single camera and for all video cameras in a layout.

To enable autozoom for a specific camera, in the viewing tile context menu, select **Enable autozoom**.

**Important**  
Autozoom is available if situational analysis is enabled on the camera in question (see [Enabling Situation Analysis](#)) or if one of the embedded detection tools is enabled (see [Creating an on-board detection tool object](#))

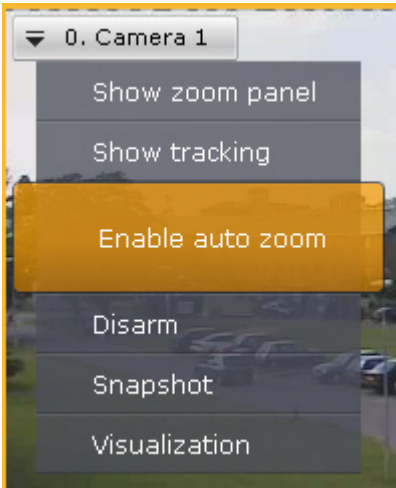

**Note**

Autozoom resizing takes into account objects from all tracking sources that are activated for a particular video camera

To disable autozoom, select the corresponding command in the viewing tile context menu.

To enable autozoom for all cameras in a layout, select **Enable autozoom for all**.

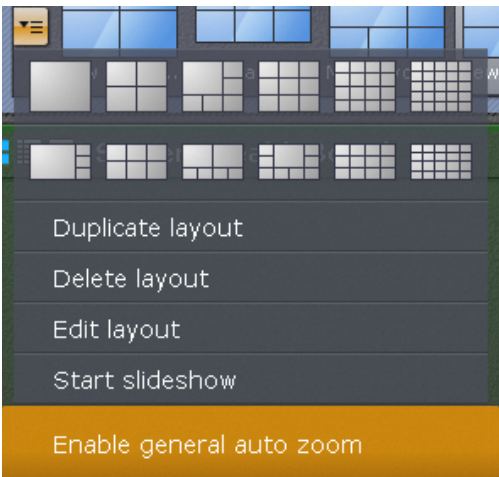

To disable autozoom for all cameras in a layout, select **Disable autozoom for all**.



**Note**

If autozoom is activated for one or more cameras in a layout, by default the menu displays the **Disable autozoom for all** option.

## Viewing the results of a saved search query

If the system has saved Forensic Search queries for a video camera, tabs for these queries are displayed in the lower-right corner of the corresponding viewing tile.



If not all tabs fit in the viewing tile, a full list of saved Forensic Search queries is available by clicking the << button.

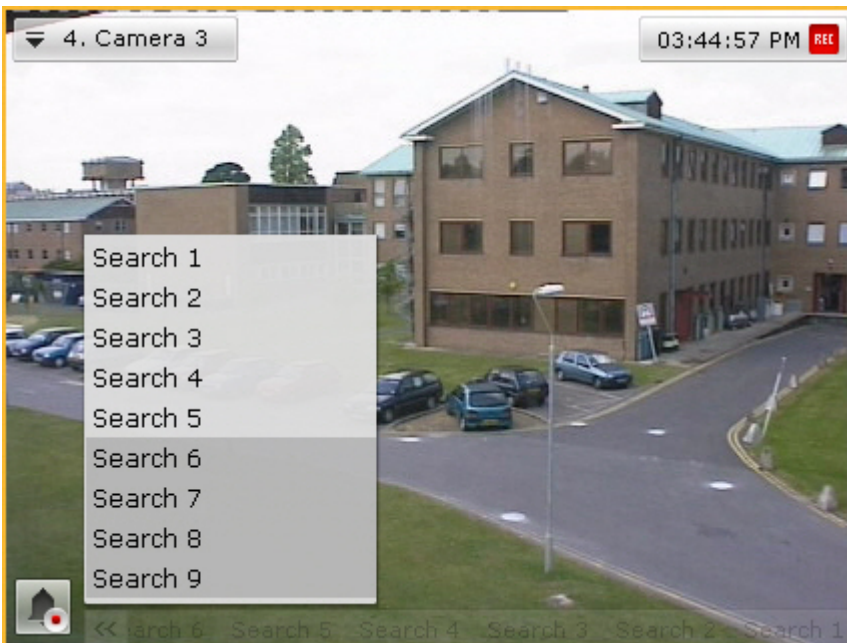

Clicking a tab switches to Archive mode, displaying the results of the relevant search on the timeline (the process is similar to viewing search results in Archive Analysis mode).

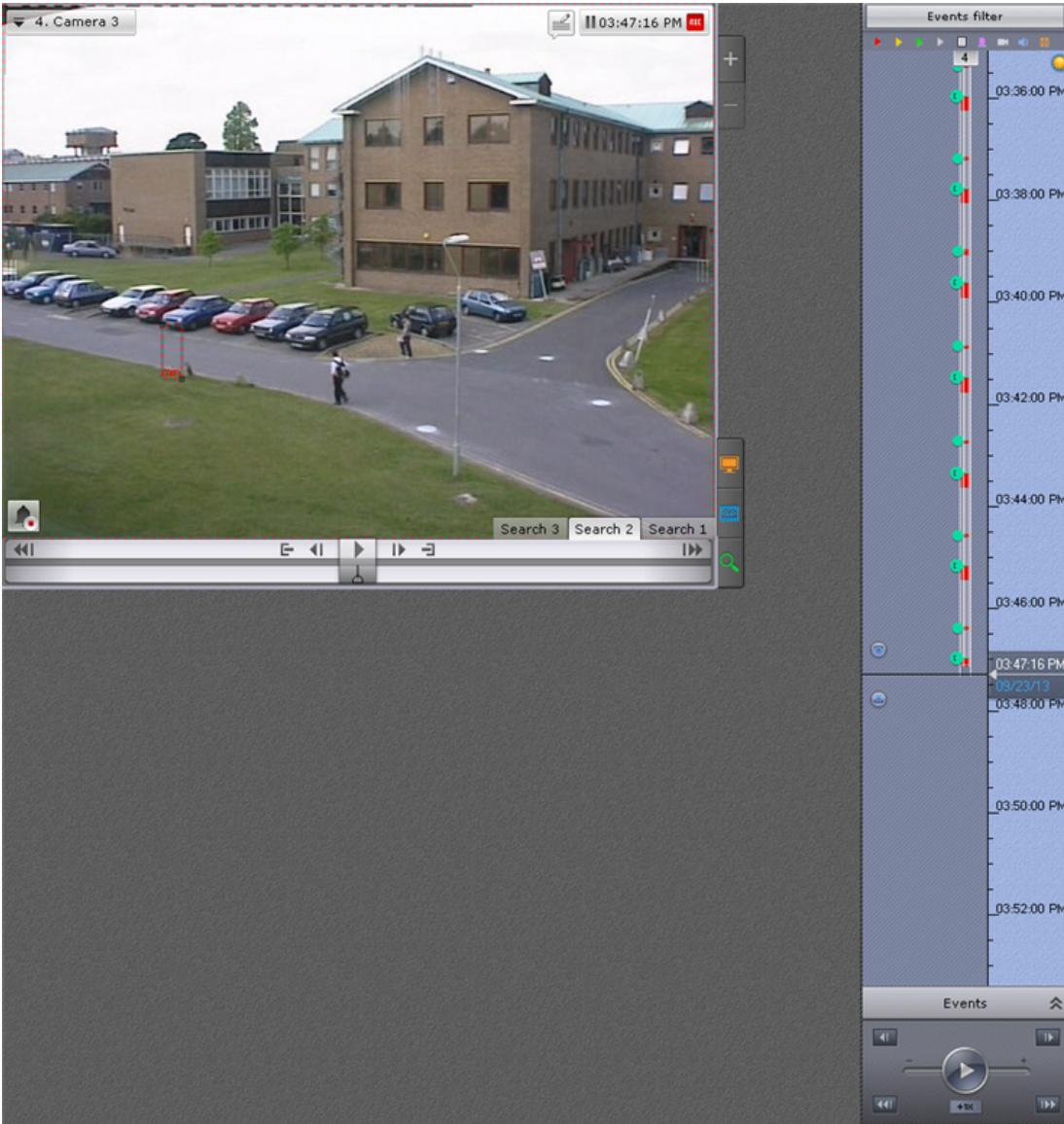

The standard Archive mode controls are used for navigating between search results (see [Navigating in the Archive](#)). To search in standard archive mode without displaying search results, click the corresponding tab in the viewing tile. The parameters for the search are displayed when switching from search results to Archive Analysis mode.

## Video surveillance in archive mode

### Switching to Archive Mode

To switch the viewing tile from a different surveillance mode to archive analysis mode, switch to the  tab in the lower-right corner of the tile.

**Note**  
If the video camera is not linked to a video archive, this tab will be unavailable.

**Note**  
In Live Video mode, if the viewing tile is not active, the tabs for switching to other modes are not displayed. To display the tabs, click the viewing tile by using either button of the mouse.



The viewing tile will then appear in archive mode.

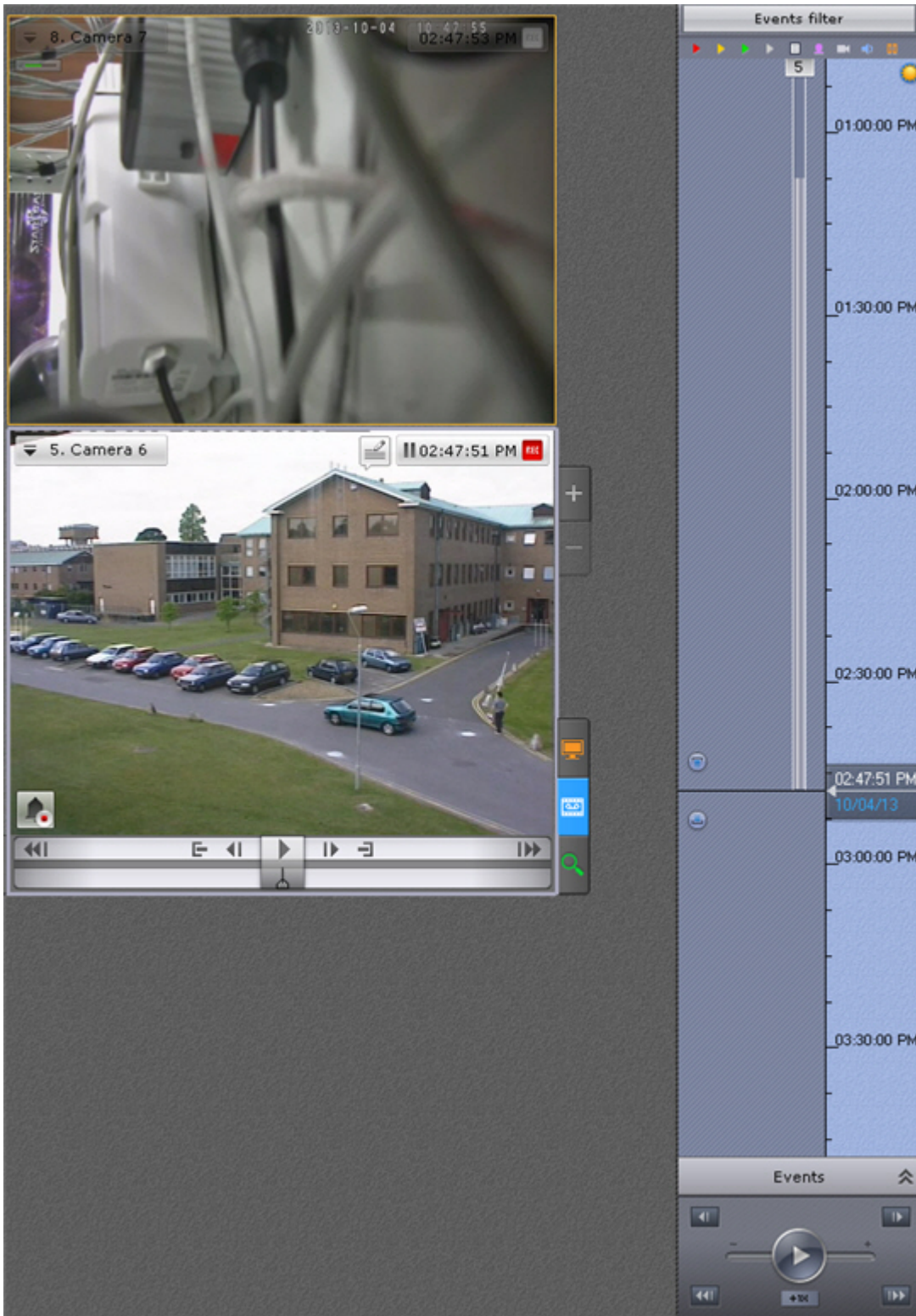

If archive mode is selected as the default video mode for a camera in a layout, when you switch to that layout, the camera is immediately in archive mode.

## Video Surveillance Functions Available in Archive Mode

In archive mode the following video surveillance functions are accessible:

1. Selecting a video camera.
2. Selecting an archive for viewing of recordings.
3. Synchronized playback of archives.
4. Viewing recorded video with operator comments.
5. Compressed playback of archives.
6. Tracking objects.
7. Autozoom.
8. Scaling the viewing tile.
9. Digitally zooming video images.
10. Navigating through the archive.

11. Playing back recordings.
12. Displaying why situation analysis detection units have been triggered.
13. Viewing the results of a saved search query.

**Note**

The following functions are accessible in all video surveillance modes: selecting a video camera, scaling of viewing tiles, digital zoom, video image processing, and **object tracking**. A description of these functions is provided in the section titled [Functions Available in All Video Surveillance Modes](#). Refer to section [Real-time video surveillance](#) for a description of switching to the results of a saved search query and the **Autozoom** function.

## Selecting an Archive

When the user switches to archive viewing, video from the default archive is displayed (see [Configuring Recording of the Video Stream from Video Cameras to the Archive](#)).

To select another archive for playback:

1. Bring up the context menu in the viewing tile (**1**).
2. Select **Archive selection** (**2**).

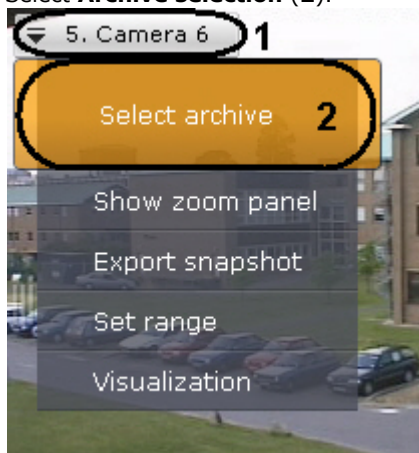

3. Select the desired archive in the displayed list.

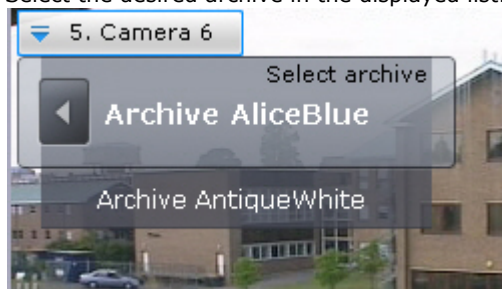

**Note**

The selected archive is displayed in bold in the list.

The selected archive will now be displayed in the viewing tile.

**Note**

If there is no recording in the selected archive, a message to that effect will appear in the viewing tile.

## Synchronized playback of archives

Synchronized playback of archives lets you play back archives from several different video cameras simultaneously.

To enable synchronized playback, switch a few video cameras into archive mode. The timeline will then display time axes for the corresponding archives.

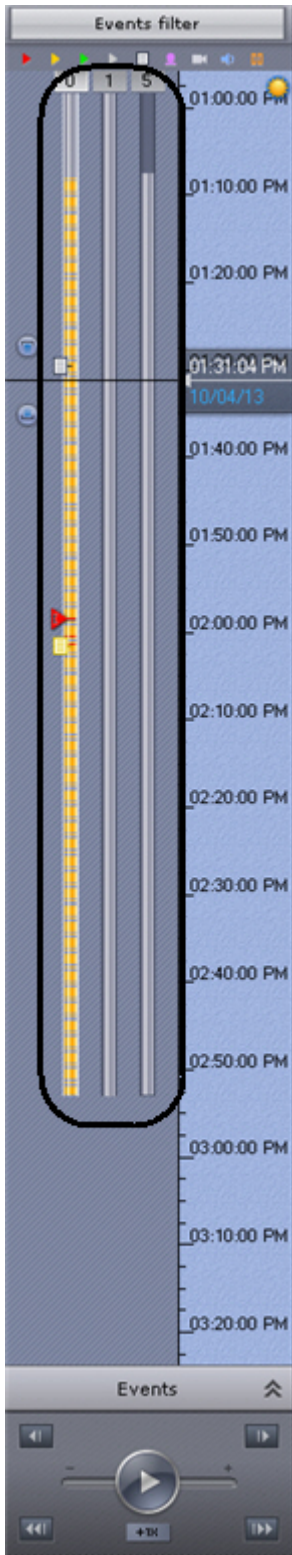

Synchronized archive playback is controlled through the playback panel in the same way as playback for a single archive.

### **Compressed playback of archives (Time Compressor)**

During compressed playback (Time Compressor), the viewing tile simultaneously displays tracked objects from different moments in time within the selected portion of the archive. This lets you quickly look through the archive to find important events and investigate them in more detail.



**Note**

Time Compressor is most useful when there are not a large number of objects constantly moving in the video camera's field of view.

### **Switching to Time Compressor mode**

To use Time Compressor, complete the following steps:

1. On the timeline, set the indicator in the position beginning from (and to the end of) where the archive will be played using Time Compressor (see the section titled [Navigating Using the Timeline](#)).

2. On the advanced navigation panel, switch to the  tab.

The archive will now start playing in compressed mode.

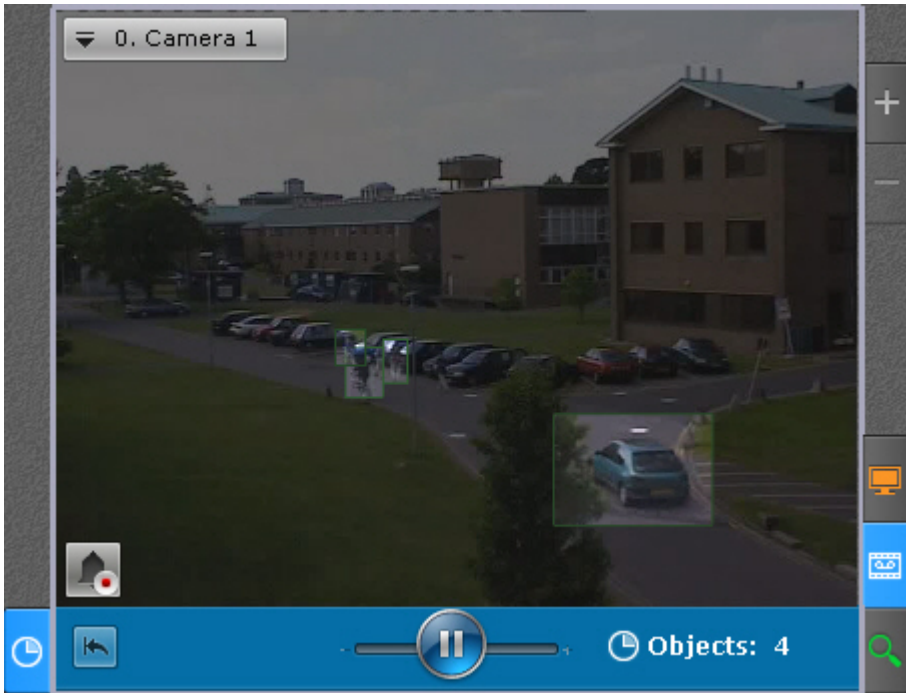

**Note**  
Only one video camera can run Time Compressor at one time. If synchronized playback is started and a video camera is switched to Time Compressor mode, playback of all other video cameras will be automatically paused.

**Note**  
To return to standard archive viewing mode, go to tab  again.

## Playback control



Playback control in Time Compressor mode is managed using the advanced navigation panel and the playback panel.

To set the desired number of tracked objects to be simultaneously displayed, set the slider in the appropriate position (**1**). The extreme left position of the slider corresponds to two objects, and the extreme right position corresponds to six objects.

**Note**  
This setting is useful only when there are not a large number of objects constantly moving in the video camera's field of view.

**Note**  
Once you have configured this setting, playback begins at the beginning of the selected interval.



To stop or start playback, use the  and  buttons on the playback panel or the identical buttons on the advanced navigation panel.

To start archive playback in Time Compressor mode starting at the beginning of the selected interval, click the  button (2).

### Switching back to the original recording of an object

To leave Time Compressor mode to go back to the original recording of an object, left-click the object.

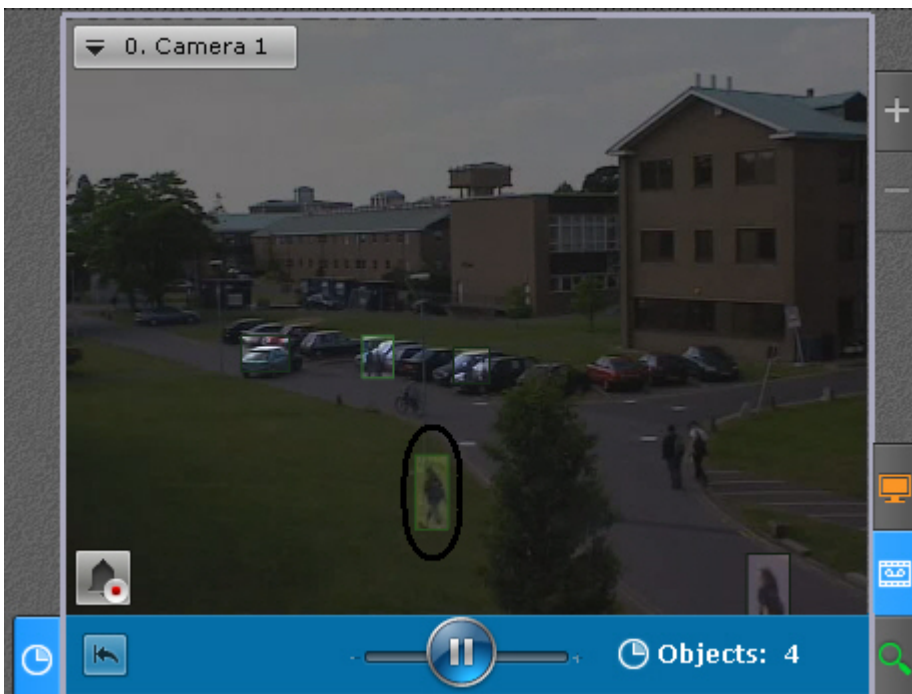

The system will now automatically switch back to the original recording of the object in standard archive playback mode. Playback of the recording will be paused, and the beginning of the recording will correspond to the moment at which the object was selected.

**Note**

Once you have switched back to the original recording of the object, you can return to Time Compressor mode to

the place where the switch was made. To do this, click the  tab. In this case, playback in Time Compressor mode will be paused.

## Viewing recorded video with operator comments

Operator comments are displayed when recorded video is played back in a viewing tile.



Comment text begins display five seconds before the frame for which the comment was added (before the first frame, if the comment was set for an interval), with gradual outlining of the area (or point) that was specified when adding the comment.

When the commented frame is shown or during the commented interval, the area (or point) is also highlighted,

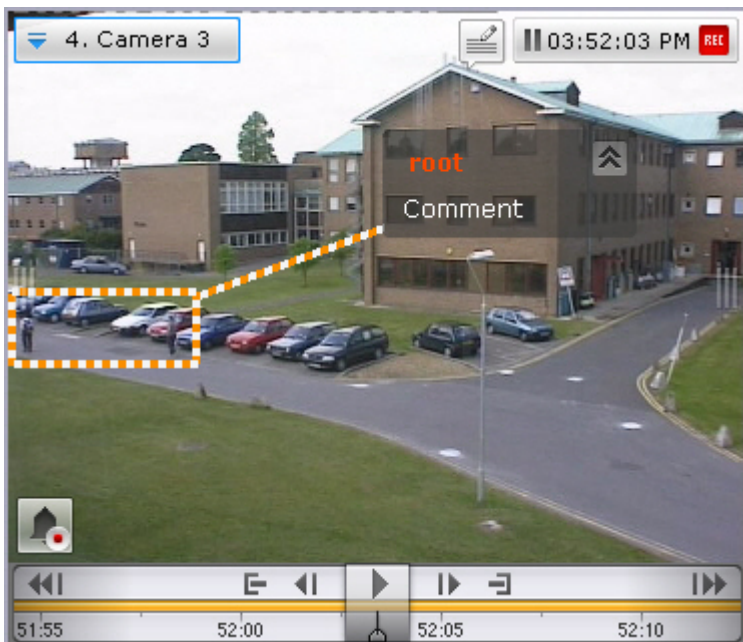

Five seconds after the commented frame (after the end of the interval, if the comment was for an interval), the comment is hidden.

To minimize comments and the displayed area, if any was specified, click the  button.



To return to the full comment, click the  button.

## Navigating in the Archive

You can navigate in the archive using the following interface elements:

1. Timeline

 **Note**  
Timeline configuration is described in detail in the section [Configuring the timeline](#).

2. Advanced navigation panel
3. Events list
4. Playback panel
5. Time indicator

You can also navigate through the archive by easily flipping through recordings.

## Navigating Using the Timeline

 **Note**  
Use of the timeline is described in detail in the section [The Timeline](#).

You can select recordings in the archive for playback in a viewing tile by using the timeline, in one of two ways:

1. Left-click the indicator **(1)** and drag it to the corresponding position on the timeline. Alternatively, you can left-click the left portion of the timeline.

 **Note**  
The position on the timeline is a graphical representation of a specific moment in time.

The frame corresponding to the selected position (moment in time) will then be displayed in the viewing tile **(2)**.

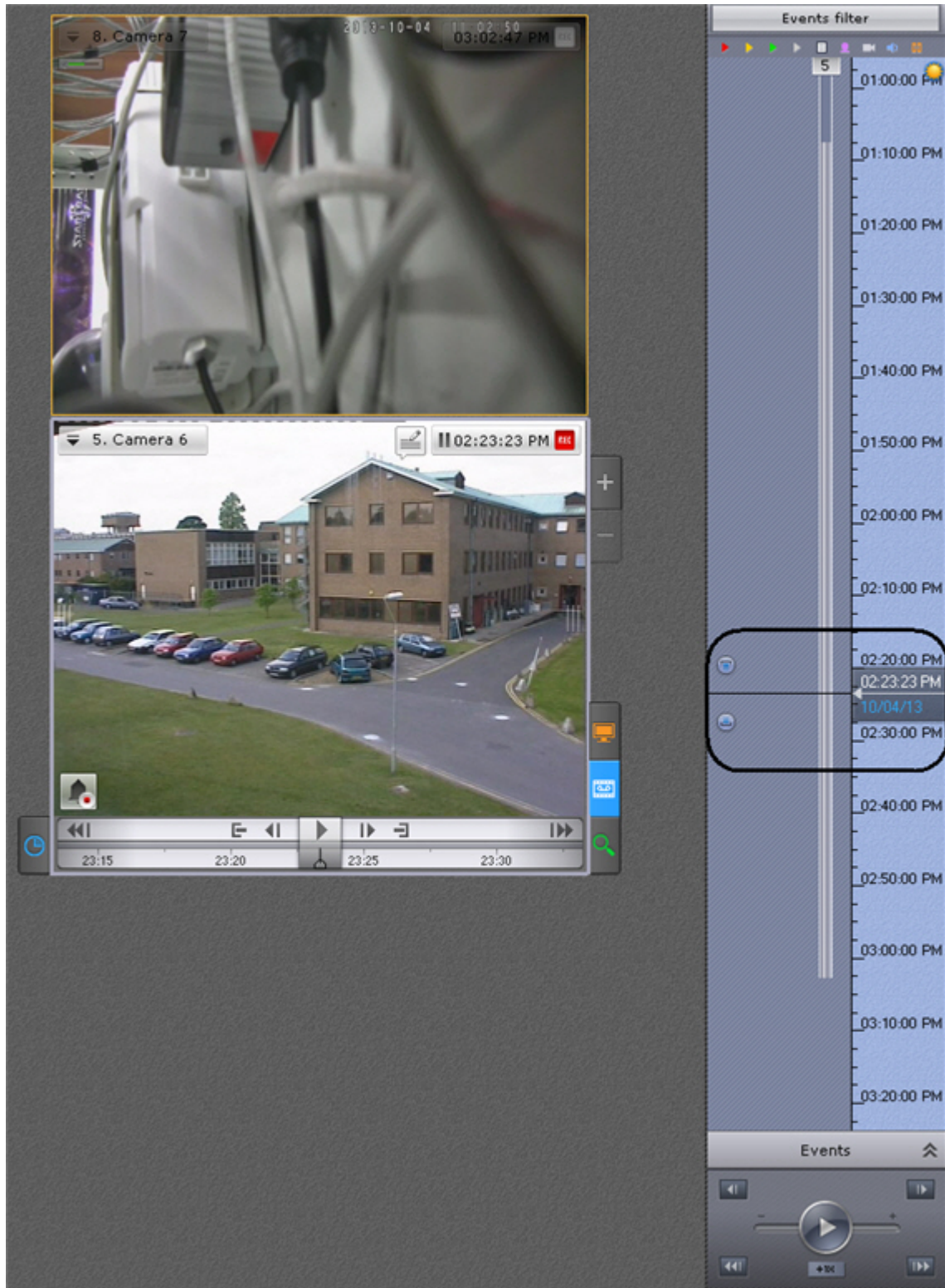

2. Click the indicator. The calendar opens. Select the date to which you want to jump in the archive and specify the time in HH:MM:SS format, by using the arrows or keyboard number keys.

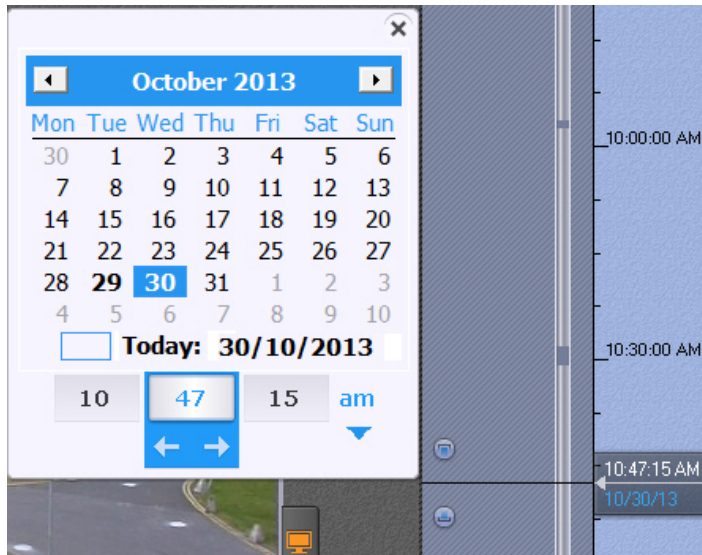

You are then taken to the specified point in the archive.

If one video camera is in archive mode and you move the indicator to a point for which there is no video, the indicator will automatically go to the video for the closest point in time. If two or more video cameras are in archive mode, you will not be taken to the video for the closest point in time; the message **No archive** will be shown on screen.

To play back the selected recording, use the playback panel (see the section titled [Navigating Using the Playback Panel](#)).

### Navigation using the advanced panel

You can use the advanced navigation panel to select recordings in the archive for playback in the viewing tile. To do this, complete one of the following two actions:

1. Left-click the timeline (1) and hold down the button while dragging the scale to the desired position.
2. Left-click the desired moment in time on the timeline.

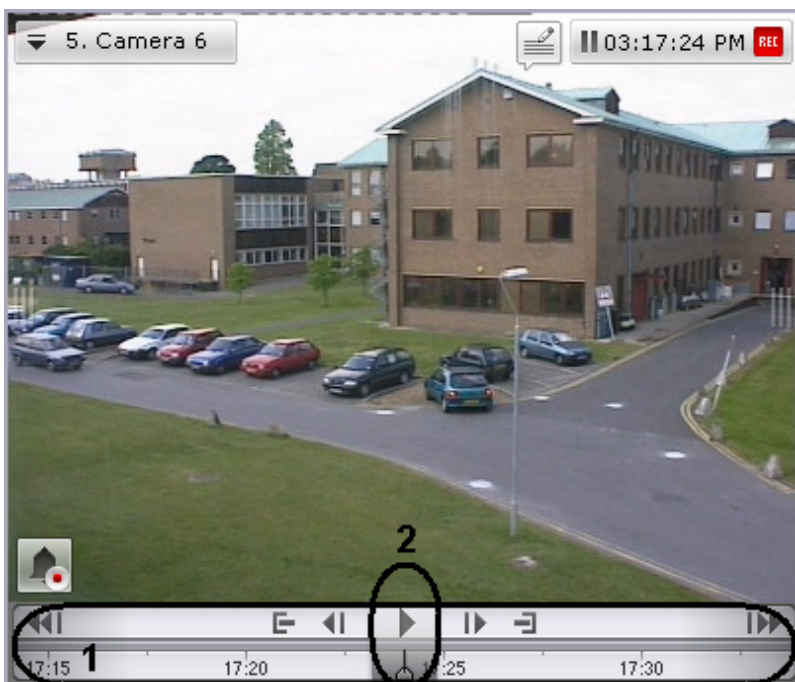



When the timeline scale is repositioned, the recording will play in fast motion from the current time to the selected moment.

#### **Note**

The current moment in time is determined by the cursor located in the center of the timeline (2). The position of the cursor relative to the timeline never changes.

Once the selected moment is reached, playback stops. The speed of playback depends on the speed of the timeline's movement.











To start archive playback click  in the middle of the timeline. To pause playback, click the  button or left-click the timeline.

You can also use the slider on the timeline to play back video footage. To flip through recordings this way you should:

1. Click and hold down the left mouse button on the timeline.
2. Move the slider to the right to fast forward video and to the left to rewind it.
3. As you move the slider, release the mouse button.

The speed of playback depends on how quickly you flip through the timeline.

To control playback, use the playback panel (see the section titled [Navigating Using the Playback Panel](#)) or the advanced navigation panel.

Playback		Pause	
Item	Description	Item	Description
	Decreases playback speed by one level		Go to the preceding frame
	Increases playback speed by one level		Go to the next frame
	Go to the previous recording		Go to the previous recording
	Go to the next recording		Go to the next recording

### Navigating Using the Events list

The Events List and the timeline are dynamically linked: when you select an event in the list, the timeline indicator automatically jumps to the selected position.

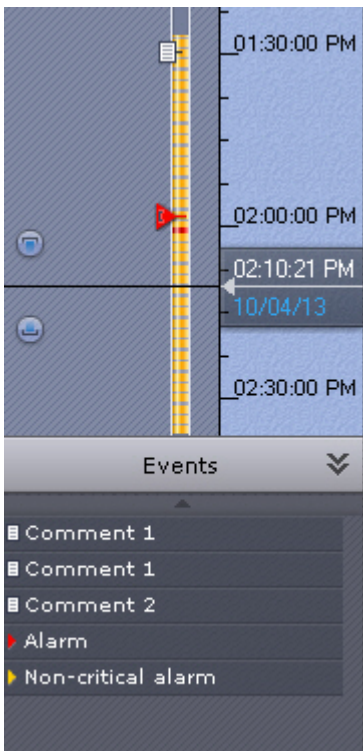

For details, see the section titled [Events List](#).

### Navigating Using the Playback Panel

To navigate in the archive using the playback panel, you must first select a recording for playback.

Once a recording is selected, the following operations are accessible:

1. Play recording: 
2. Pause/Stop playback: 
3. Go to the preceding frame  .
4. Go to the next frame  .
5. Go to the previous recording  .
6. Go to the next recording  .

It is possible to change the mode (forward/reverse) and speed of playback. To do this, use the slider.

Rapid reverse playback of an entry:



Rapid forward playback of an entry:



For reverse playback of a recording, move the slider to the left of the position corresponding to zero playback speed (the center of the slider); for forward playback, move it to the right. The current playback speed is displayed under the slider. During forward playback of a recording, a + sign appears before the speed; during reverse playback, a - sign appears.

The value **0X** corresponds to zero speed, i.e., no playback; the value **1X** corresponds to the frame rate of recording.

At a speed less than 1X, playback is slower than the speed of recording; at speeds greater than 1X, it is faster.



**Note**

Both forward and reverse playback may be accelerated up to 16X.

**Navigation via the time indicator**

The time indicator in a viewing tile can be used to set the time of the current day on the timeline to which you want to navigate in the archive.

To do so, left-click the indicator and specify the time in HH:MM:SS format, by using the arrows or keyboard number keys.

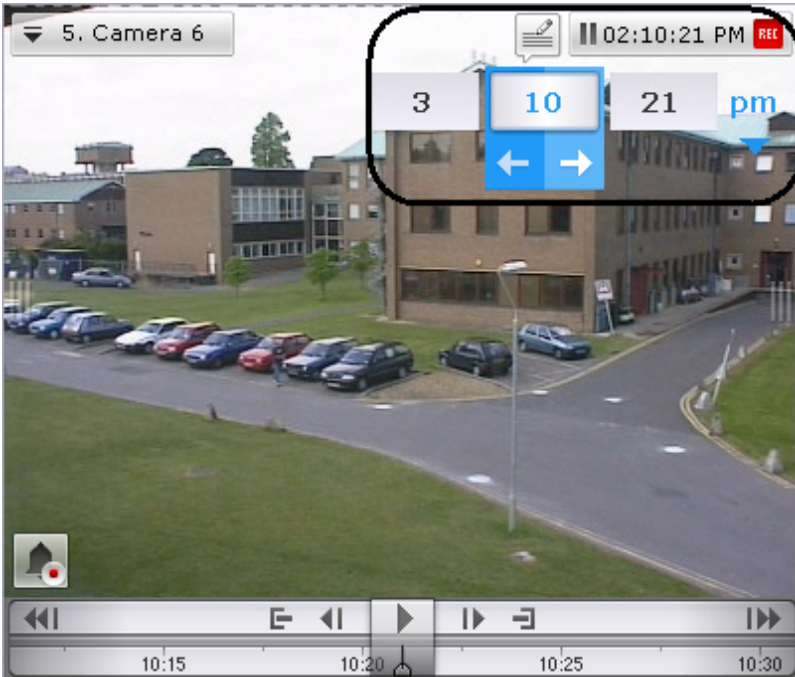

You are then taken to the specified point in the archive.

If one video camera is in archive mode and you try to navigate to a point for which there is no video, you will be automatically taken to the video for the closest point in time. If two or more video cameras are in archive mode, you will not be taken to the video for the closest point in time; the message **No archive** will be shown on screen.

### Keyboard navigation

You can use keyboard shortcuts to navigate through an archive and control video playback.

Key or key combination	Resultant action during pause	Resultant action during play
Spacebar	Begins playback	Pauses playback
Ctrl+Spacebar	Uses the current position to set the export interval	Uses the current position to set the export interval
Up-Arrow	Increases playback speed by one level	Increases playback speed by one level
Down-Arrow	Decreases playback speed by one level	Decreases playback speed by one level
Left-Arrow	Moves back to the preceding key frame	-
Right-Arrow	Moves forward to the next key frame	-
Page up	Switches to the preceding recording	Switches to the preceding recording
Page down	Switches to the next recording	Switches to the next recording

### Flip-through navigation of recordings

The viewing tile lets you easily flip through recordings.

Use the buttons on the sides of the viewing tile to flip through recordings. Click the button on the left side of the viewing tile to play the preceding recording (1), and click the button on the right side of the viewing tile to play the next recording (2).



If you already have a recording in playback mode when flipping to a new one, then the new recording will automatically begin playback once the flip is complete.

### Displaying the causes of triggered situation analysis detection units

When positioning the archive in the range [-1 sec.; +1 sec.] from when the situation analysis detection unit was triggered, the objects that triggered the detection unit will be marked on the video frame.



### Video surveillance in Alarm Management mode

#### Video surveillance functions available in Alarm Management mode

The following video surveillance functions are available in Alarm Management mode:

1. Selecting a video camera.
2. Scaling the viewing tile.
3. Digitally zooming video images.
4. Processing video images.
5. Forwarding and reversing playback of an alarm at various speeds.
6. Evaluating alarms (assigning a status).

**Note**

The following functions are accessible in all video surveillance modes: selecting a video camera, scaling of viewing tiles, digital zoom, and video image processing. A description of these functions is provided in the section titled Functions Available in All Video Surveillance Modes

### Play corresponding video

## Initiating an Alarm

A system alarm can be initiated in one of two ways:

1. Manually (by an operator)
2. Automatically (when a detection tool is triggered)



#### Note

You can initiate an alarm only if the specific video camera is linked to the archive.

### Manual Initiation

To initiate an alarm manually, you must perform the following steps:

1. In the lower-left corner of the viewing tile, click the  button.

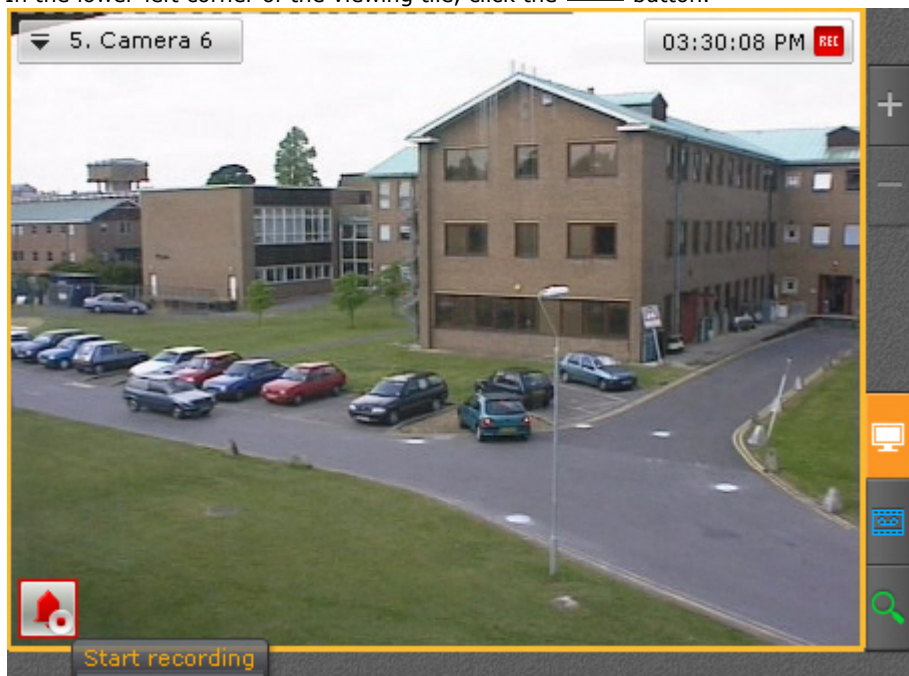

2. An alarm will then be initiated in the system and the viewing tile will automatically switch to alarm mode for evaluation of the situation.



#### Note

When in Alarm Management mode, the user that initiated the alarm will be indicated at the bottom of the viewing tile.



Manual initiation of an alarm is now complete.

### Automatic Initiation

An alarm is initiated automatically if a **Record and alarm** rule, to be executed when a detection tool is triggered is triggered, is activated (see the section titled [Recording to Archive and Initiation of an Alarm](#)).

If an alarm is initiated automatically, a color-coded indicator will appear on the **Alarms** tab and the alarm preview tile will be displayed in the bottom left corner of the viewing tile (the video recording of the beginning of the alarm event plays repeatedly) while the rest of the viewing tile will be dimmed.

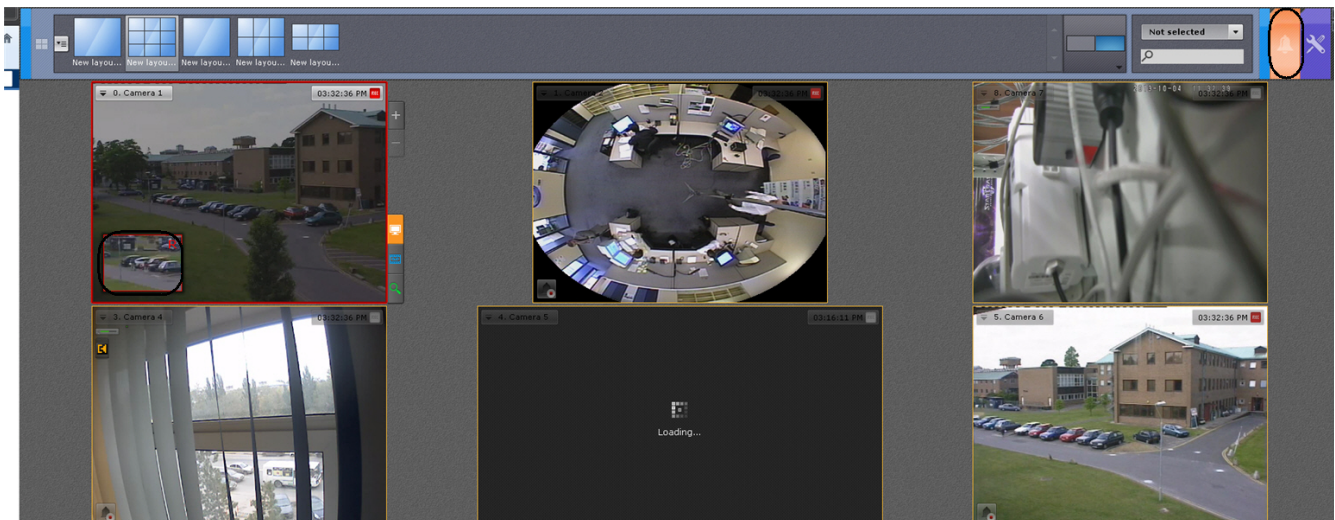

To evaluate the situation, go to the **Alarms** tab or left-click the alarm preview tile and then accept the event for processing (see the section titled [Accepting an alarm for processing](#)).

### Accepting an alarm for processing

To accept an alarm for processing, go to the **Alarms** tab. All currently active alarm events are displayed on this tab. Under each alarm event you can see the name of the video camera that registered the alarm. If the alarm was initiated by a detection unit, the alarm event will be marked by the icon of the specific detection unit. To accept an alarm for processing, left-click the alarm event or the alarm preview tile.

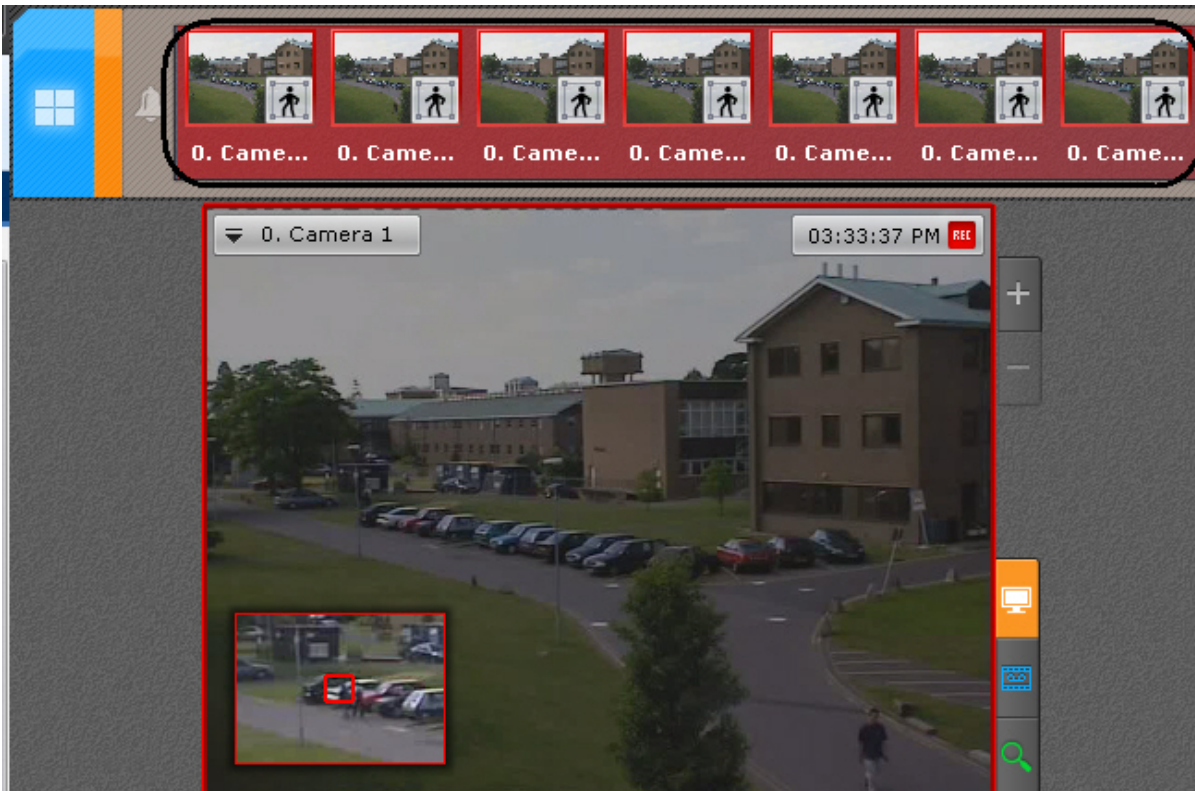

The alarm handling tile will then appear.



**Note**

The Alarm Management tile will be displayed if you click the alarm preview tile.



## Switch to Alarm Management mode

When an alarm is initiated, the system switches to alarm mode automatically at the moment the event is accepted for processing. Operator can escape the Alarm management mode. To return a viewing tile from a different surveillance mode

to Alarm Management mode, in the lower-left corner of the tile, click the  button.



The viewing tile will then appear in **Alarm Management** mode.

If there are multiple alarms for a camera, Alarm Management mode will open to the most recent alarm.

# Working with the Alarm Management window

## Alarm Handling Tile Interface Elements

The alarm handling tile is a viewing tile which, besides the standard interface elements (context menu, time indicator, etc.), also contains elements for alarm playback and evaluation:

1. Playback panel
2. Timeline
3. A button for quick positioning of the timeline indicator in the position corresponding to the beginning of the alarm.

## Alarm Playback

As soon as an alarm is accepted for evaluation, the alarm recording is played back automatically one time, at 1X speed. Playback is launched either from the moment of the beginning of the alarm, or from the moment corresponding to the position of the alarm flag (only when the alarm is initiated automatically; see the section [Recording to Archive and Initiation of an Alarm](#)).



If the alarm was initiated automatically, the visual element set for the detection tool which initiated the alarm will be displayed in the viewing tile: or a detection area or virtual tripwire, which triggers the detection tool when it is crossed. The object which caused the trigger will be outlined with a red frame.

Display of an Area visual element:



Display of a Line visual element:





The name of the detection unit that initiated the alarm is displayed in the lower portion of the viewing tile.

Motion

To go to the desired segment of the alarm event to replay it, left-click the timeline indicator and drag it to the corresponding position.



**Note**  
To go to the required video fragment, you can also left-click in the corresponding area of the timeline.



To switch to the previous result, click  on the playback control panel or move the timeline indicator to the following position: .



Once a segment is selected for replay, the following operations are accessible:

1. Play recording: 
2. Pause/Stop playback: 
3. Go to the preceding frame 
4. go to the next frame 

It is possible to change the mode (forward/reverse) and speed of playback. To do this, use the slider.

Reverse playback of a video fragment:



Forward playback of a video fragment:



For reverse playback of a recording, move the slider to the left of the position corresponding to zero playback speed (the center of the slider); for forward playback, move it to the right. The current playback speed is displayed to the left of the slider. During forward playback of a recording, a + sign appears before the speed; during reverse playback, a - sign appears.

The value **0X** corresponds to zero speed, i.e., no playback; the value **1X** corresponds to the frame rate of recording. At a speed less than 1X, playback is slower than the speed of recording.

**Note**

The maximum speed of forward and reverse playback is 1x.



## Processing an Alarm

To process an alarm, use the group of colored buttons in the lower left-hand corner of the Alarm Management tile. After processing of the alarm, the viewing tile on the given client automatically switches to Live Video mode. The alarm is no longer in the **Alarms** tab.

**Attention!**

In the case of multi-user event processing, only the first operator to switch to alarm mode may process the alarm (if he or she has the appropriate permissions). For the rest of the operators, the Alarm Management buttons are not displayed.



Button	Executed function
	Critical alarm
	Non-critical alarm
	False alarm

## Limitations when working with alarm events in case of multi-user processing

In the case of multi-user processing, only one operator may accept an alarm for processing. Other operators may switch to alarm mode with limited functions for the purpose of playing back the alarm. This can be done in one of two ways:

1. Click the  button (see the section [Video surveillance in Alarm Management mode](#)).
2. Switch to the **Alarms** tab and select the alarm from the alarms list.



In Alarm Management mode with limited functions, the Alarm Management buttons are not displayed. Instead, the name of the operator who is currently processing the alarm is displayed. The other functions of the alarm handling tile remain unchanged.

After processing of the alarm on another client, on the given client the status assigned to the alarm is displayed in place of the name of the operator.

If a user has accepted an alarm for processing and leaves Alarm Management mode (going to Live Video mode, Archive or Archive Search mode, the viewing tile for another camera, etc.), after an amount of time equal to the operator's idle time after leaving, other users will also have the opportunity to accept the alarm for processing.

If more than one alarm appears for one camera, any operator may access all alarms not yet accepted for processing.

## Video surveillance in Archive Search mode

### Switching to Archive Search mode



To switch the viewing tile from a different surveillance mode to archive analysis mode, switch to the  tab in the lower-right corner of the tile.

**Note**

If the video camera is not linked to a video archive, this tab will be unavailable.

**Note**

In Live Video mode, if the viewing tile is not active, the tabs for switching to other modes are not displayed. To display the tabs, click the viewing tile by using either button of the mouse.

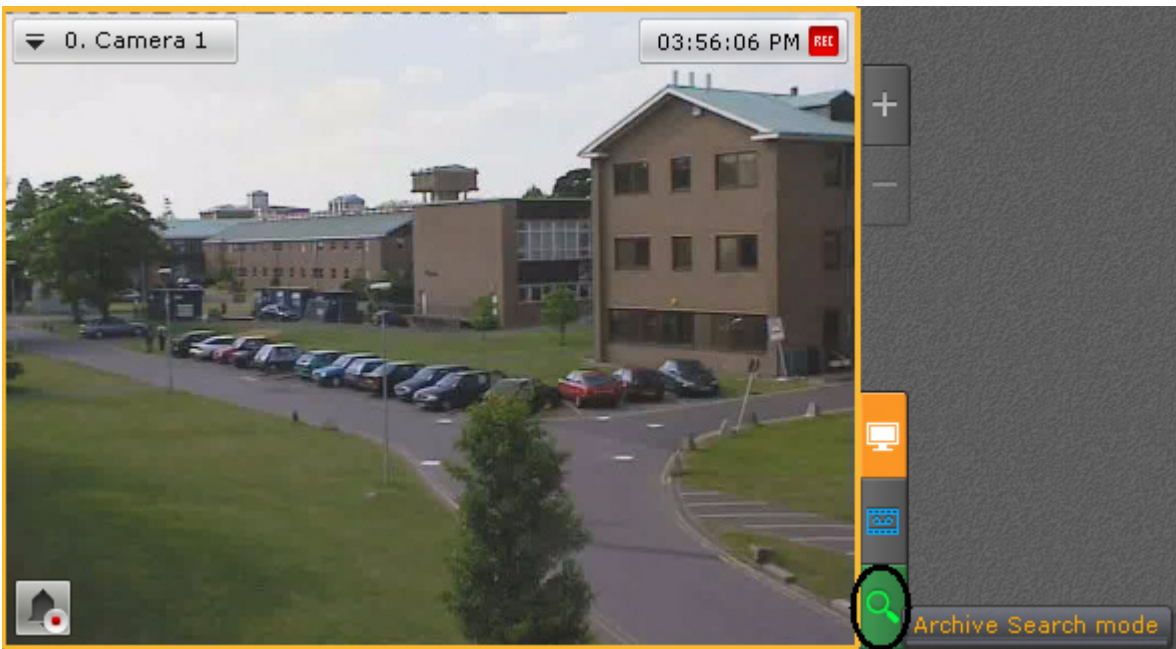

The archive analysis interface will then appear.

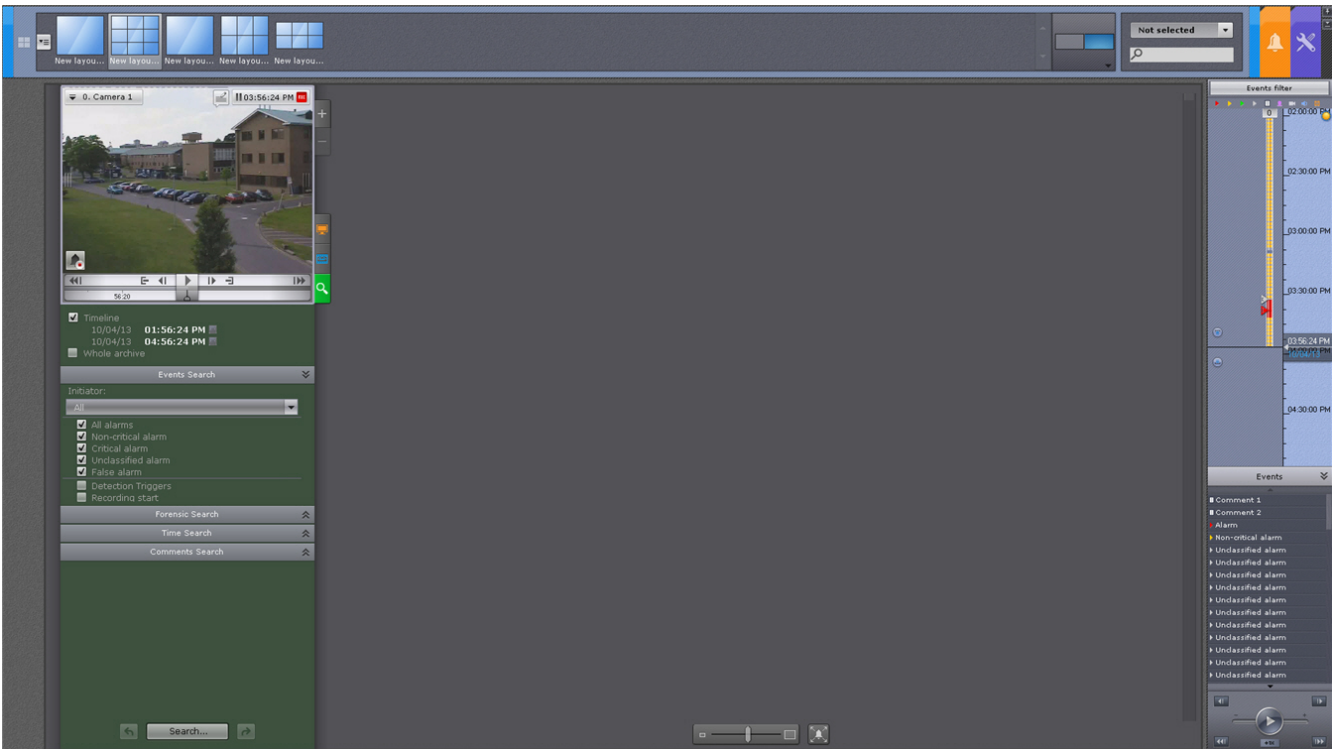

## Archive Search mode interface

The visual layout of Archive Search mode is divided into the following 4 components:

## 1. Viewing tile (1)

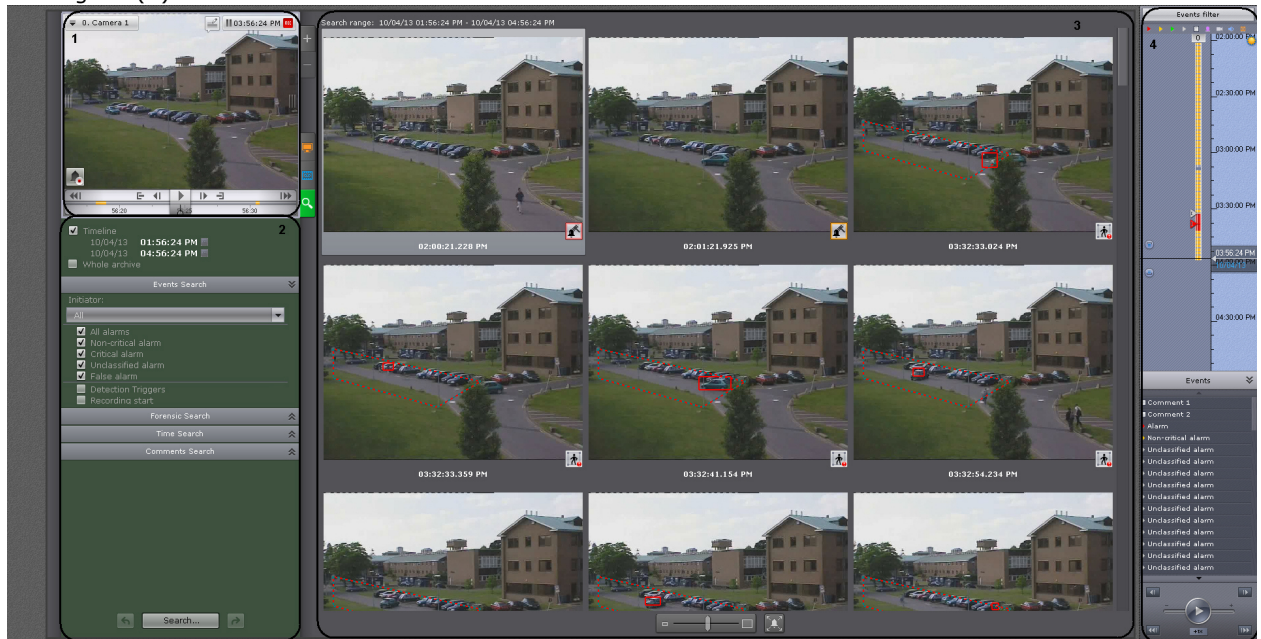

2. Search control panel (2)
3. Search results panel (3)
4. archive navigation panel (4)

The viewing tile and archive navigation panel are described in their respective sections (see [Viewing Tile](#) [The Archive Navigation Panel](#)).

The search control panel consists of three tabs that handle different types of searches:

1. Events Search (2).
2. Forensic Search.

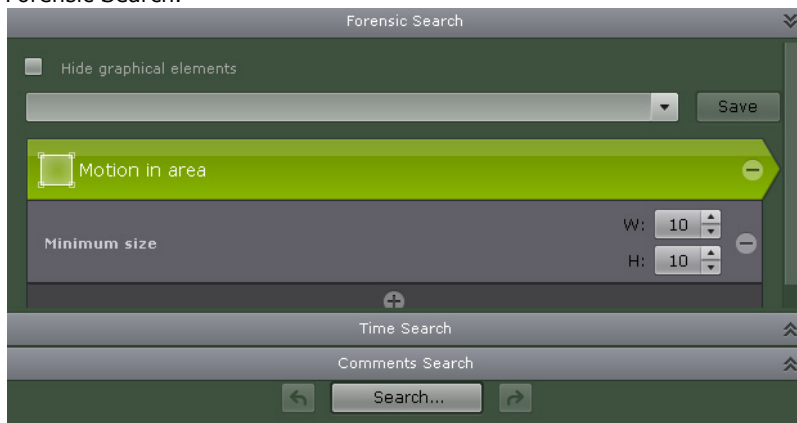

3. Time Search.

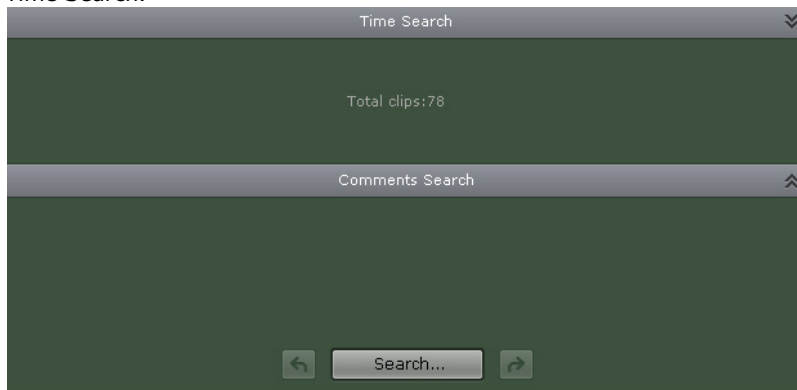

4. Searching comments.

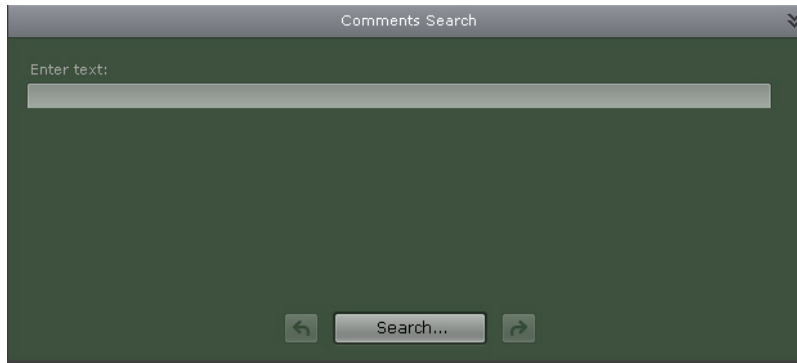

The search results panel displays the precise moments in an archive that correspond to the defined search criteria. The precise time of each moment is displayed underneath (1). The specific moments correspond to the beginnings of the video fragments.

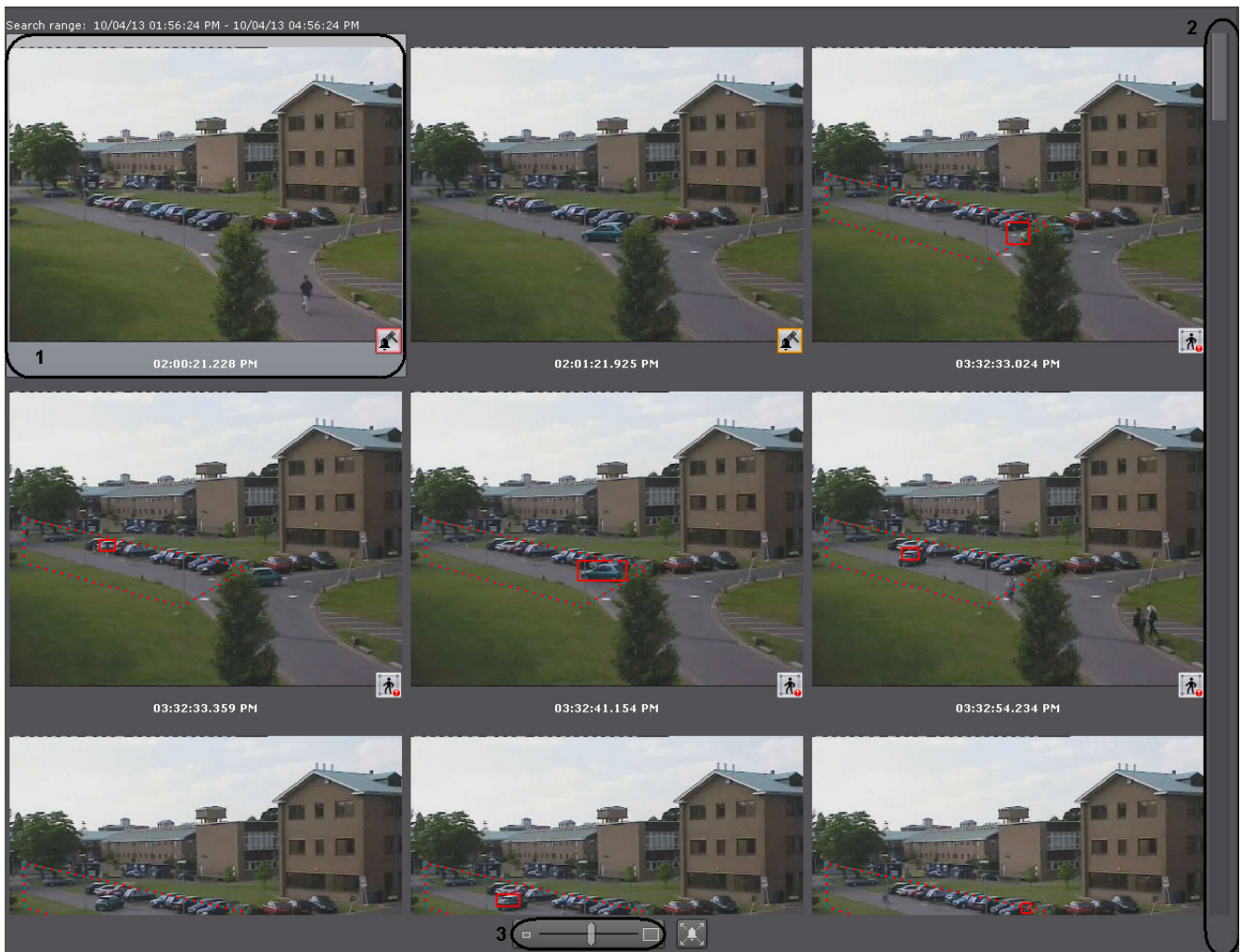

A scroll bar is located on the right side of the search results panel (2). Beneath is a time scale adjuster (3).

## Video surveillance functions available in Archive Search mode

In Archive Search mode, the following video surveillance functions are available:

1. Selecting a video camera.
2. Selecting an archive for video recording analysis.
3. Tracking objects.
4. Autozoom.
5. Scaling the viewing tile.
6. Digitally zooming video images.
7. Processing video images.
8. Navigating through the archive.
9. Display of the causes of triggered situation analysis detection units.
10. Viewing recorded video with operator comments.
11. Events search.
12. Forensic search.

13. Time search.
14. Searching comments.
15. Switching between search results.
16. Playing back fragments retrieved by searches of specific moments in time.
17. Zooming in on objects that trigger detection tools.



**Note**

The following functions are accessible in all video surveillance modes: selecting a video camera, scaling of viewing tiles, digital zoom, video image processing, and **object tracking**. A description of these functions is provided in the section titled [Functions Available in All Video Surveillance Modes](#). The functions for navigating through an archive, displaying the causes of situation analysis detection unit triggering, and **Archive Selection** were inherited from archive mode; their descriptions are [Video surveillance in archive mode](#). The Autozoom function is described in the [Real-time video surveillance](#) section.

## Setting a search interval

Setting a search interval follows the same procedure for all types of archive search.

You can select the following search intervals:

- Visible portion of the timeline (the **Timeline** check box)
- All of the archive for the video camera (the **Whole archive** check box)

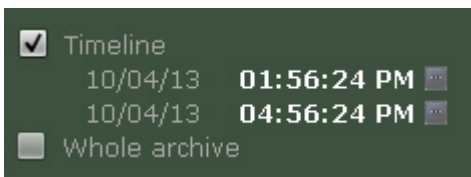

The visible portion of the timeline can be changed by navigating through it or by directly setting an interval. To set a beginning and end point for search, use the buttons.

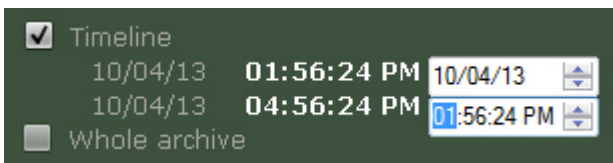

The date format is DD/MM/YY and the time format is HH:MM:SS. The minimal time interval is one minute.

## Events search

This type of search lets you select events in the archive based on the type of event.

To do this, complete the following steps:

1. Set the search interval (see [Setting a search interval](#)).
2. Define search criteria.
  - a. Select an event initiator from the list (1).



**Note**

An event initiator could be an operator, a video camera sensor, or any detection unit that is activated in the system. The search results will show the moments in time containing the events that were triggered by the initiator.



- b. Select the events you need to search. Select the appropriate check boxes (see table below and **2** on the picture above).

**Note**  
You can select an unlimited number of events.

Event	Description
All alarms	The search finds moments in the archive containing all types of alarms
Non-critical alarm	The search finds moments in the archive containing non-critical alarms
Critical alarm	The search finds moments in the archive containing critical alarms
Unclassified alarm	The search finds moments in the archive containing unclassified alarms
False alarm	The search finds moments in the archive containing false alarms
Triggering	The search finds moments when detection units were triggered
Recording start	The search finds the beginning and end of recordings from the specified video camera regardless of the initiator

3. Click the **Search** button (**3**).

This starts a search in the archive based on the defined criteria. Search results are available on the search results panel.

**Note**  
To zoom objects that caused an alarm or triggered a detection unit, select the **Expand alarm object** check box in the lower portion of the search results panel.

## Forensic Search for Fragments

Forensic Search lets you search for moments in the archive using the following criteria:

1. Motion in Area + two subcriteria:
  - loitering of an object in a specific area;
  - simultaneous presence of a large number of objects in a specific area.
2. Crossing of a virtual line by an object's trajectory.
3. Motion from one area to another.

### Forensic Search steps

Forensic Search is carried out in several steps:

1. Set the search interval (see [Setting a search interval](#)).
2. Select a search criterion.



**Note**

In the current version of *Axxon Next*, you can search only by one criterion at a time.

3. Edit the visual element necessary to carry out the search based on the selected criterion.
4. Configure the criterion parameters.
5. Start the search and view the results.
6. If necessary to save the search query, in order to quickly view its results from Live Video mode.

Steps 3 and 4 are used to refine the search query. These steps can be skipped, in which case the search will be carried out using the default parameters or previously set parameters (see the note below). For example, in the first case, using the **Motion in Area** criterion, a search will be made for any motion in the central area of the frame with a width and height equal to 40% of the width and height of the frame, respectively (see the section titled [Area](#)), regardless of the size of the moving object, its color, or the direction and speed of its motion.



**Note**

The visual element necessary for searching the selected criterion and the parameters of the criterion are saved if the user switches to another search criterion, exits forensic search mode, or even restarts *Axxon Next*.

### Selecting search criteria and adding parameters

A search criterion is already selected when you switch to Forensic Search: the criterion is either the last one used (if a search was performed previously) or the default criterion **Motion in Area**.

To remove a search criterion, click the button.

To add a criterion, click the button and select the necessary criterion from the list.

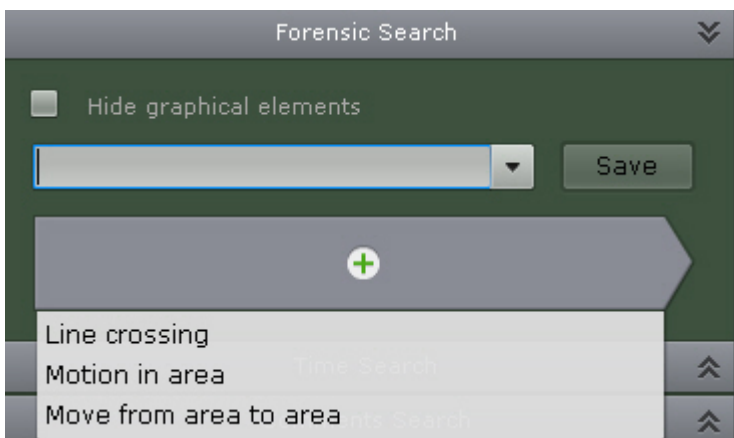

After this, you can add search parameters by using the button as well.

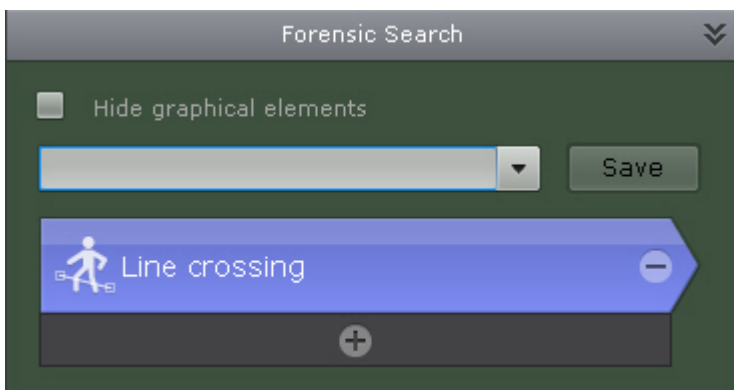

The subcriteria **Loitering in area** and **Multiple Simultaneous Objects in Area** are selected as parameters for the **Motion in the Area** criterion.

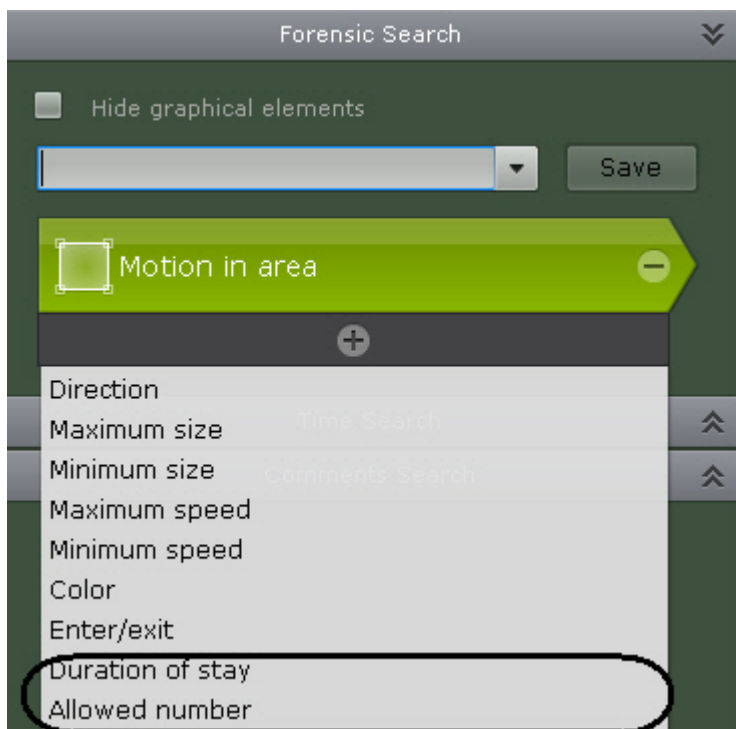

### Editing visual elements

The **Area** visual element is used for the **Motion in Area** criteria, the **Line** visual element for the **Line crossing** criterion, and the **Two areas** visual element for the **Movement from Area to Area** criterion.

The visual element displayed by default must be edited to conform to the needed search query; for example, it may be necessary to increase or decrease the search area, move the virtual line, etc.



#### Note

You can collapse the graphical elements if they block the visual elements and prevent editing them. To hide them, select the **Hide graphical elements** check box.

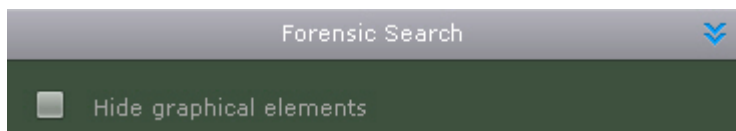

### Line

The **Line** visual element is required for searching recorded video by the **Line crossing** criterion. This visual element sets a virtual line in the field of view of a video camera; instances of something crossing this line will be found in the archive.

The end points of the line are connected by a two-colored dotted line. The direction of the object's motion across the line is indicated by dotted arrows.

By default, the end points of the line have the coordinates (50%, 30%) and (50%, 70%) as percentages of the width and height of the frame, respectively.

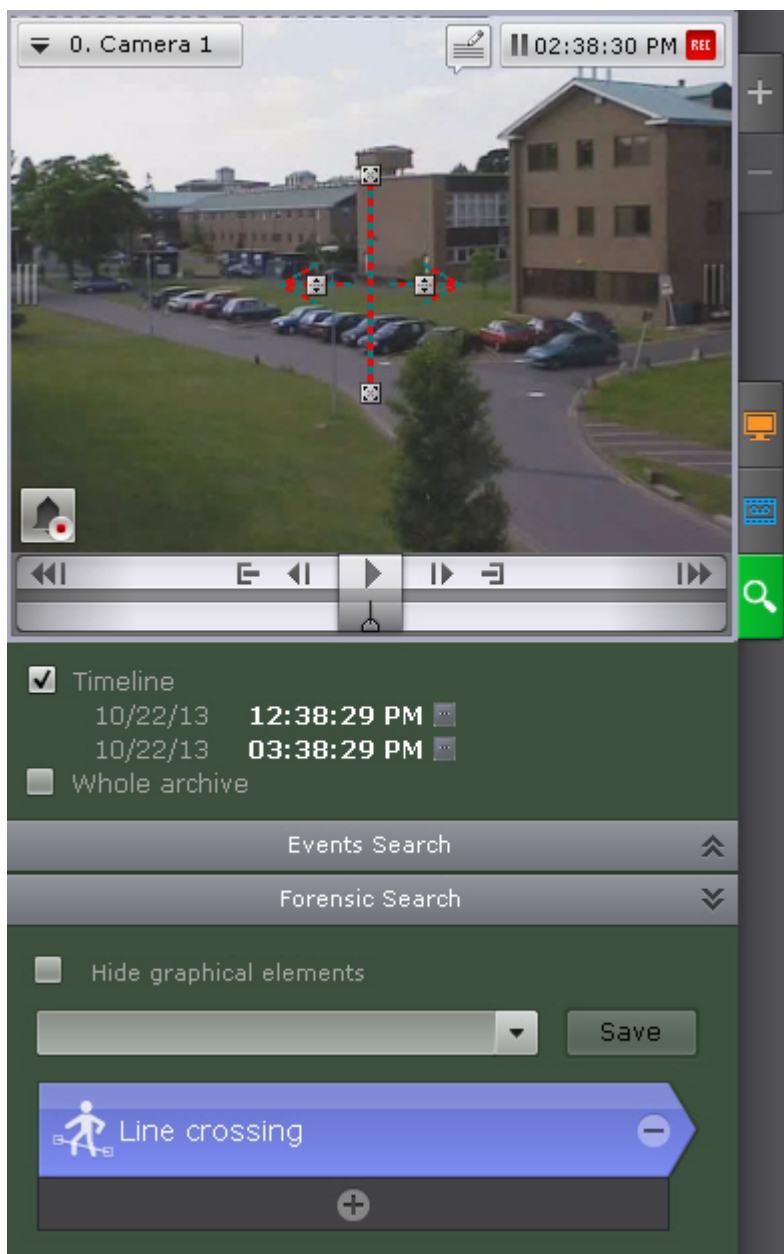

To move the end point of a line, position the cursor on the end point and hold down the left mouse button as you move the mouse.

By default, both directions of motion across the virtual line are taken into account when searching the archive. If you do not need to search in a specific direction, click the  button corresponding to that direction.



**Attention!**

At least one direction must be selected for the search.



**Note**

A disregarded direction of object motion is indicated by a dimmed arrow.

**Area**

The **Area** visual element is required for searching recorded video by the **Motion in Area** criterion. This visual element specifies the area in a video camera's field of view that is to be analyzed when searching by the selected criterion.

The nodes of an area are connected by a two-colored dotted line.

By default, an area is defined by 4 nodes with the coordinates (30%, 30%), (70%, 30%), (70%, 70%) and (30%, 70%) as percentages of the width and height of the frame, respectively.

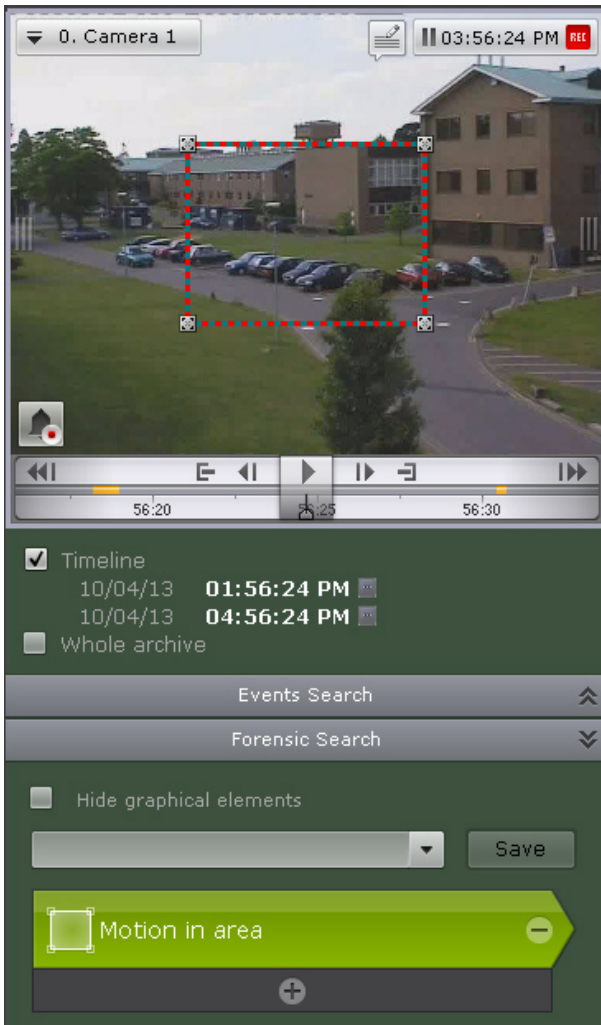

To edit an area, use the following actions.

Action	Result
Right-click on a line	Creates a new area node
Right-click on a created node	Deletes the area node
Position the cursor on a node and hold down the left mouse button while you move the mouse	Moves the area node

## Two areas

The **Two areas** visual element is required for searching recorded video by the **Movement from Area to Area** criterion. This visual element defines two areas in the video camera's field of view; instances of something moving between them (from one to the other) can be found in the archive.

The nodes of each area are connected by a two-colored dotted line. The direction of motion between the areas is indicated by a dotted arrow.

By default, each area is defined by 4 nodes. The nodes of the first area have the coordinates (20%, 40%), (40%, 40%), (40%, 60%), (20%, 60%), and those of the second have the coordinates (60%, 40%), (80%, 40%), (80%, 60%), (60%, 60%) as percentages of the width and height of the frame, respectively.

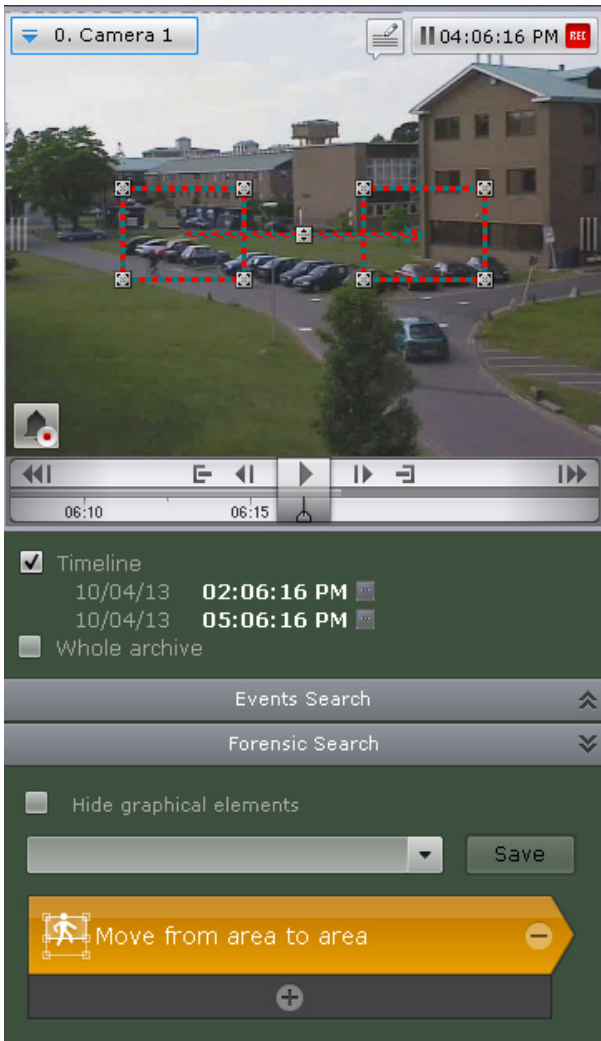

Each area can be edited the same way as the visual element **Area** (see the section titled [Area](#)).

To change the direction of motion between the areas, click the  button on the direction arrow.

### Configure the search parameters

It is not required to specify parameters, but for more precise results, it is possible to set one or more parameters for each criterion:

The search criteria	Possible parameters
Motion in Area (main criterion)	Direction of movement Maximum and minimum object size Maximum and minimum object speed Object color Entry/exit from area
Motion in Area (loitering in area)	Duration of object's presence Maximum and minimum object size Object color
Motion in Area (many objects in area)	Allowable number Maximum and minimum object size Object color
Object trajectory crossing a virtual line Motion from area to area	Maximum and minimum object size Maximum and minimum object speed Object color

## Configuring minimum and maximum object size

The procedures for setting the minimum and maximum size of a moving object are identical.

The minimum (or maximum) size of a moving object can be set using any of the following methods:

**Note** The first method lets you roughly configure the size, and the second method allows you to set the size precisely.

1. Position the cursor on a visual element node and hold down the left mouse button while moving the mouse (**1**).

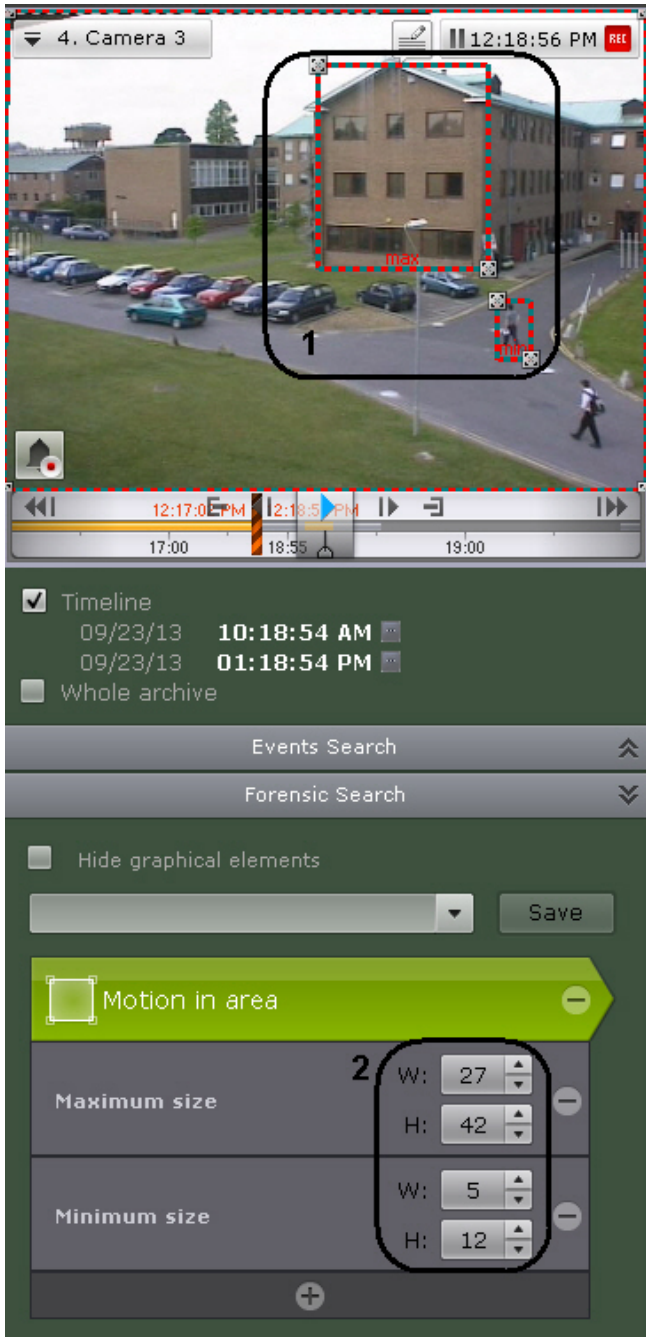

2. Set the width and height of an object of the minimum (maximum) size using the arrows in the upper and lower margins, respectively. The dimensions of a visual element in the viewing tile can be changed in a similar manner (**2**).

The minimum (maximum) size of an object is now set.

## Configuring minimum and maximum object speed

The procedures for setting the minimum and maximum speed of a moving object are identical.

The minimum (or maximum) speed of a moving object can be set using any of the following methods:

**Note** The first method lets you roughly configure the speed, and the second method allows you to set the speed

precisely.

1. Position the cursor on an end point of the arrow and hold down either mouse button while you move the mouse. The length of the arrow will correspond to the minimum (maximum) displacement of the object per second (**1**).

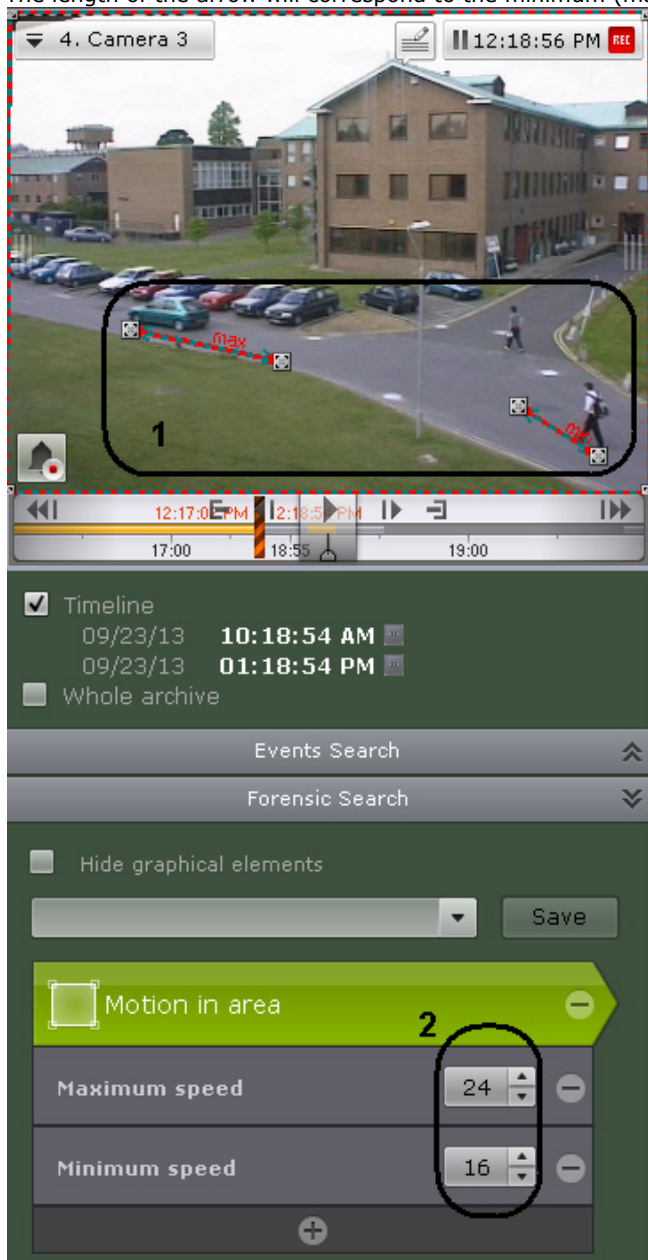

2. Use the arrows to set the minimum (maximum) speed of the object as percentages of the frame per second. The dimensions of the arrow in the viewing tile can be changed in a similar manner (**2**).

The minimum (maximum) speed of a moving object is now set.

### Configuring object color

The color range is selected using drag and drop on the color palette (click and hold either mouse button, move the mouse, then release the button).

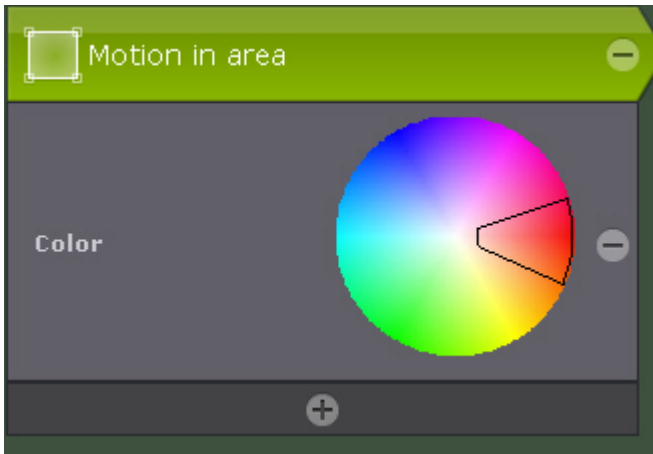

**Attention!**

Any click on the palette is interpreted as the beginning of a new range; the previous range will disappear.

**Configuring direction of object movement**

By default, when searching the archive, the system searches for motion in all directions. It is possible to prevent searching for motion in one or several specific directions.

Click with either mouse button to designate a direction in which you do not want to perform movement search (privacy mask). The sector corresponding to the direction is then colored gray. If necessary, repeat this action for other directions. To reactivate searches for a masked (gray) direction, click it again with either mouse button.

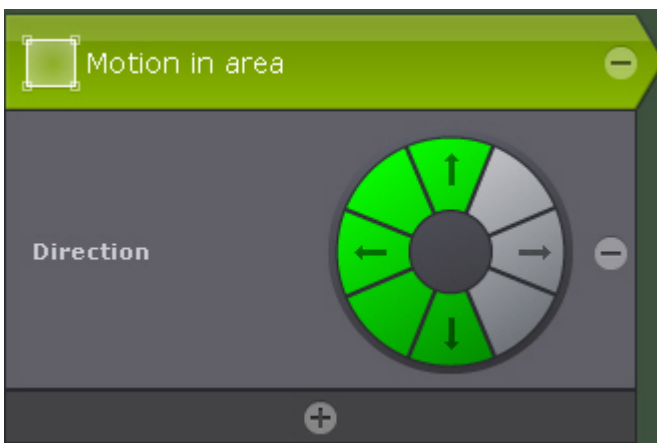

The required directions of an object's movement are now set.

**Configuring object entry/exit from area**

"Entry" occurs when an object enters the field of view and crosses its boundaries; "exit" occurs when an object disappears from the field of view and crosses its boundaries.

To find moments when an object enters an area, select **Entr**, or for moments when an object exits an area, select **Exit**.

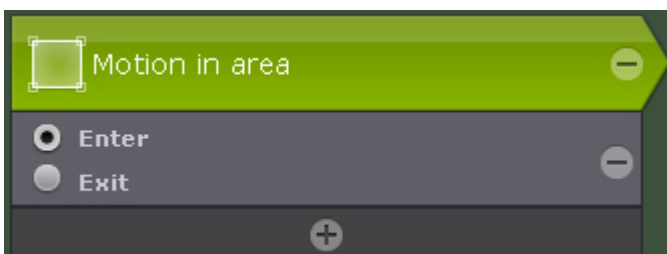

**Configuring duration of object presence in area**

To find objects that have been present in an area for a long time, set the necessary length of time in minutes and seconds.

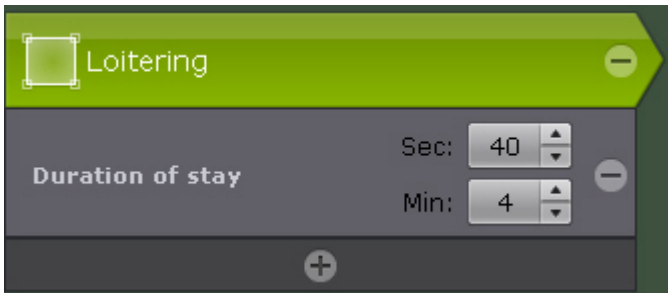

Search results contain recorded video in which the object is present in the area for longer than the indicated time.

#### **Configuring threshold value for number of objects in an area**

To find moments when a large number of objects accumulate in an area, set a threshold number of objects that are allowed in the area.

Search results contain recorded video in which the number of objects in the area exceeds the specified number.

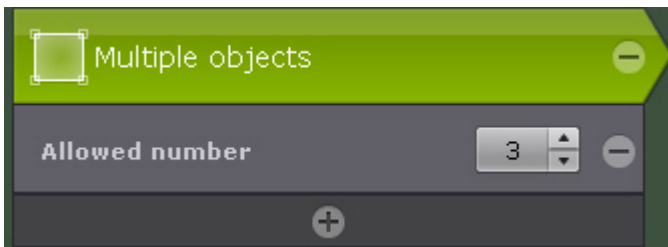

#### **Launching a search**

To start a search, click the **Search** button in the search control panel.



#### **Attention!**

The search will be performed for the time period displayed on the timeline.

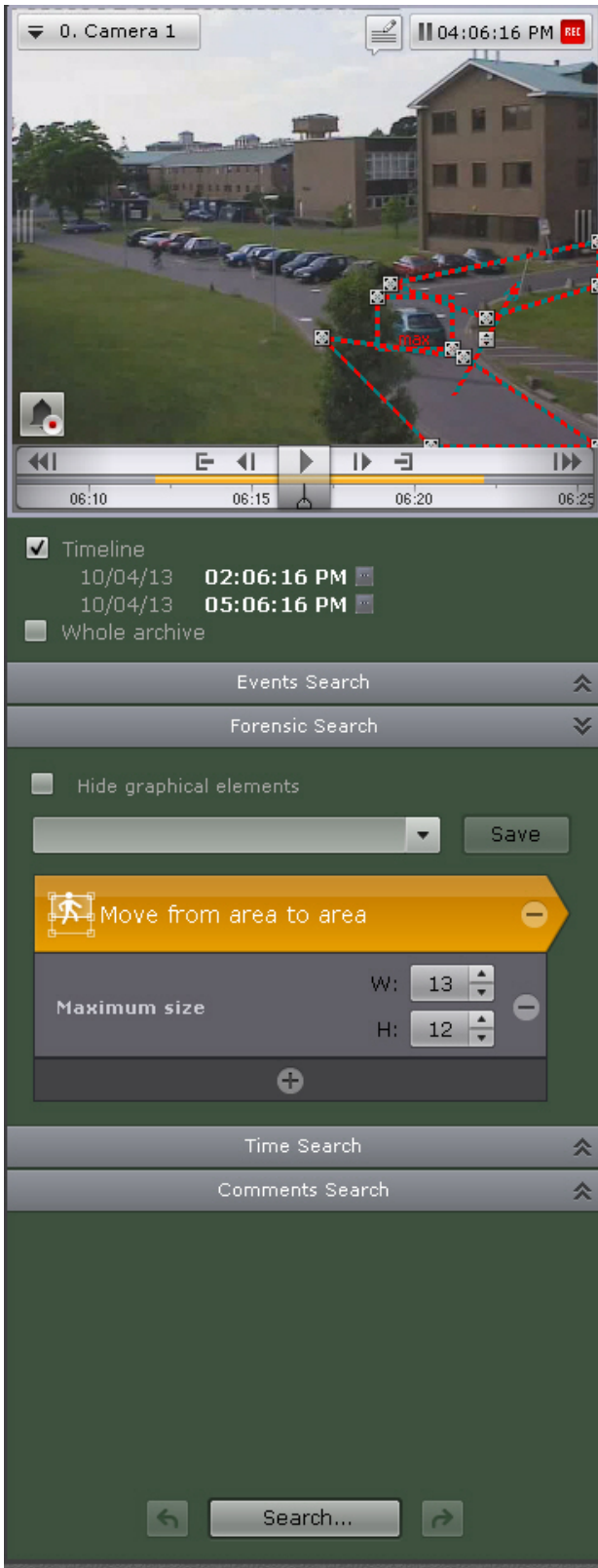

The search results panel will display the specific moments found.

### Saving search queries

Saving a search query allows quickly switching to the results from Live View and Archive modes.

To save a search query, specify a name **(1)** and click the **Save** button **(2)**. After this, the tab for the search query becomes available in the lower-right corner of the viewing tile in Live Video and Archive modes (see [Viewing the results of a saved search query](#)).



To edit a search query, view the list and select the relevant query.

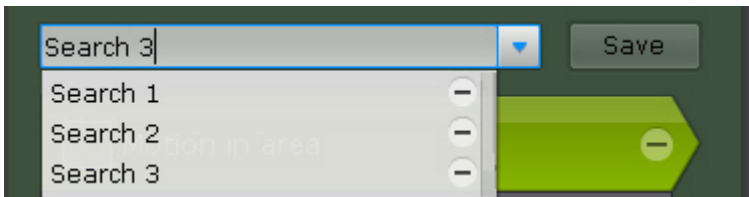

Changes are not saved until the **Save** button is clicked. If the query name is changed, the query is saved under the new name and the old, unchanged query remains available.

To delete a search query, click the  button.

## Time search for video fragments

A time search lets you divide a selected portion of the archive into equally sized fragments with a certain interval between them.

A time search is performed as follows:

1. Set the search interval (see [Setting a search interval](#)).
2. Click the **Search** button.

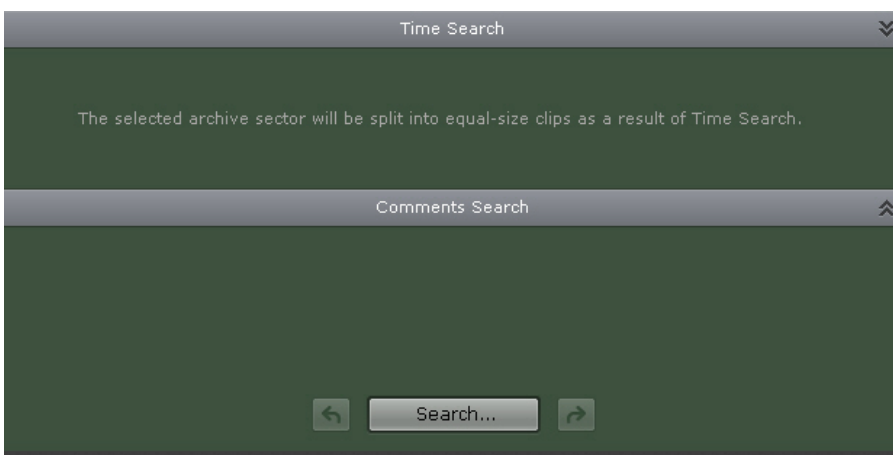

This starts a search for video fragments based on the defined criteria. The search results panel displays frames that match moments in time that are equally spaced from each other; the search control panel shows the number of fragments found.

**Note**

Information on playback of video fragments is provided in the section titled [Playback of video fragments](#)

## Searching comments

Comments search allows filtering for comments that contain certain text.

To search comments:

1. Set the search interval (see [Setting a search interval](#)).
2. Enter the text that you want to find in comments.

**Attention**

Search is performed for the entire string of entered text, not for separate words.

**Note**

If no text is specified, all comments for the selected interval are found.

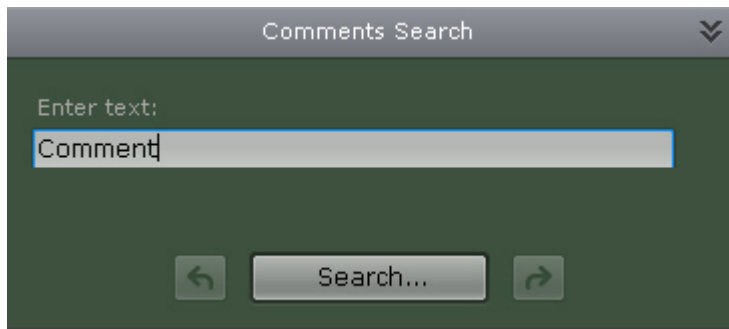

3. Click the **Search** button.

This starts a search for video fragments based on the defined criteria. The search results pane displays frames for which there are comments containing the search text. The relevant comment is displayed under each frame.

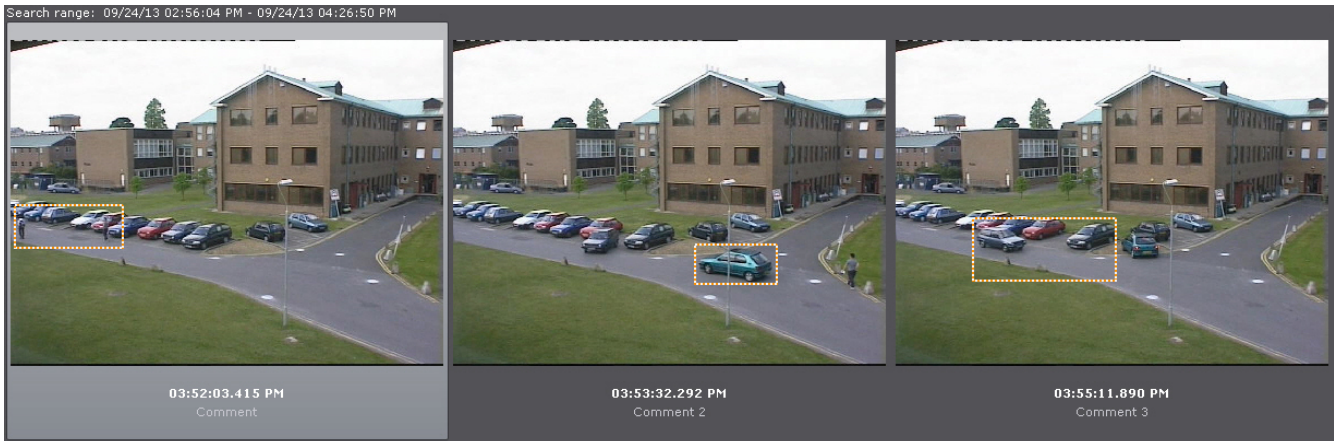
**Note**



If the comment was left for an interval, the first frame of the interval is displayed.

## Switching between search results

If a search was run more than once and the user did not exit Archive Search mode during that time, it is possible to switch between search results.

**Note**

The number of stored results is limited only by the amount of RAM in the server.

Click  on the search control panel to switch to the previous search result, and click  to switch to the next result.

Each time you switch between results, the search results panel displays the moments corresponding to the previous/next result.

# Working with video fragments corresponding to found moments

## Playback of video fragments

To view the video fragment corresponding to a found moment in the archive, complete the following steps:

1. Left-click the found moment on the search results panel.
2. Using the playback panel (1), start playback of the fragment in the viewing tile (2).

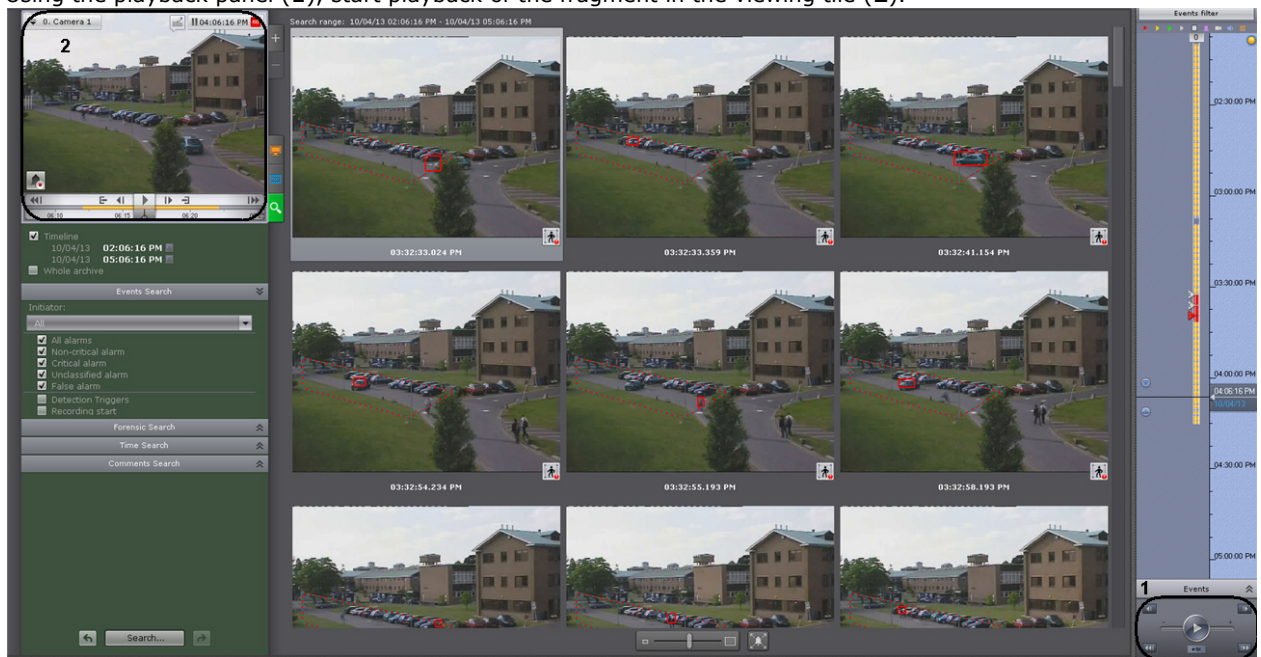

### Note

If object tracking is activated in the viewing tile, then the properties of tracked objects (width and height as a percentage of the width or height of the frame) are displayed when viewing video fragments found through forensic search.

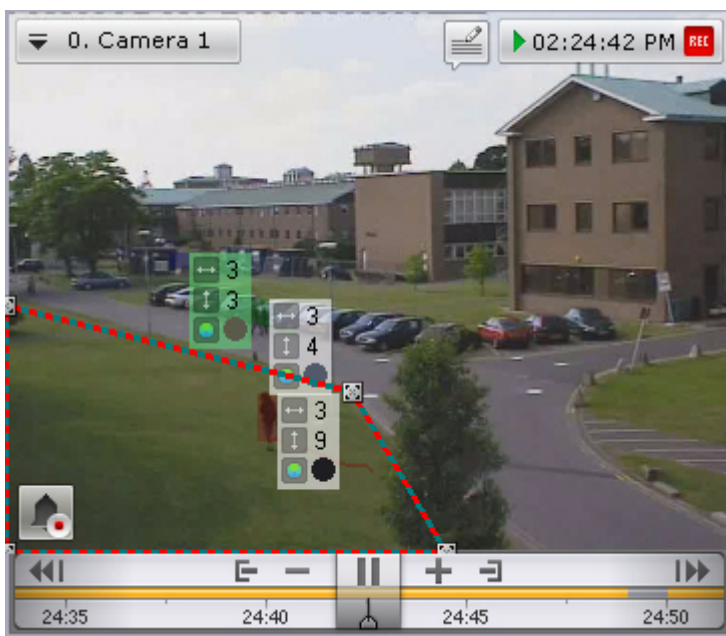

### Note

To switch between video fragments, use the corresponding buttons on the playback panel or on the advanced navigation panel (see the sections titled [Navigation using the advanced panel](#) and [Navigating Using the Playback Panel](#)).

## Enlargement of found moments

When you find moments in archive video, you can enlarge the following:

- Object that triggered the detection tool (during event search).
- Track (during forensic search).
- Commented area of the frame (during comment search).

To do so, above the search results, click the  button.



#### Attention!

Enlargement occurs only in the following cases:

1. If the height and width of the visual item specified in the forensic search settings is less than 1/3 of the frame dimensions.
2. If the tracking object occupies less than 1/3 of the frame (for detection tool search)
3. If the object marked by the comment occupies less than 1/3 of the frame (for comments search)

In all other cases, the found moments are displayed in their entirety.



To close zoom, click the  button again.

## Exporting the video fragments and repeated search

To export the video fragment corresponding to a found moment in the archive:

1. Double-click the found moment on the search results panel. The interval for export will be set apart from this moment until the next found moment.



#### Important

Double-clicking the found moment will also cause a repeated search within the selected time interval for export.

2. Export the video (see [Exporting Video Recordings](#)).

## Working with fisheye cameras

### Viewing modes for video from fisheye cameras

Axxon Next allows viewing the video stream and video archive from fisheye cameras, dewarping the video image into one of the following formats:

1. 360 panorama.
2. Regional view.
3. 180 panorama (for video camera with an Immersion lens).

### 360 degree Panorama and Regional view (virtual telemetry)

By default, video from fisheye cameras is displayed in viewing tiles as a 360 panorama.



When digital zoom is applied to video (see [Digitally Zooming Video Images](#)) by one notch or more, regional viewing begins. The following actions are available when viewing video in this format:

1. Point & Click functionality (see [Control using Point&Click](#)).
2. Change the angle of view of the fisheye camera, by left-clicking in the viewing tile.

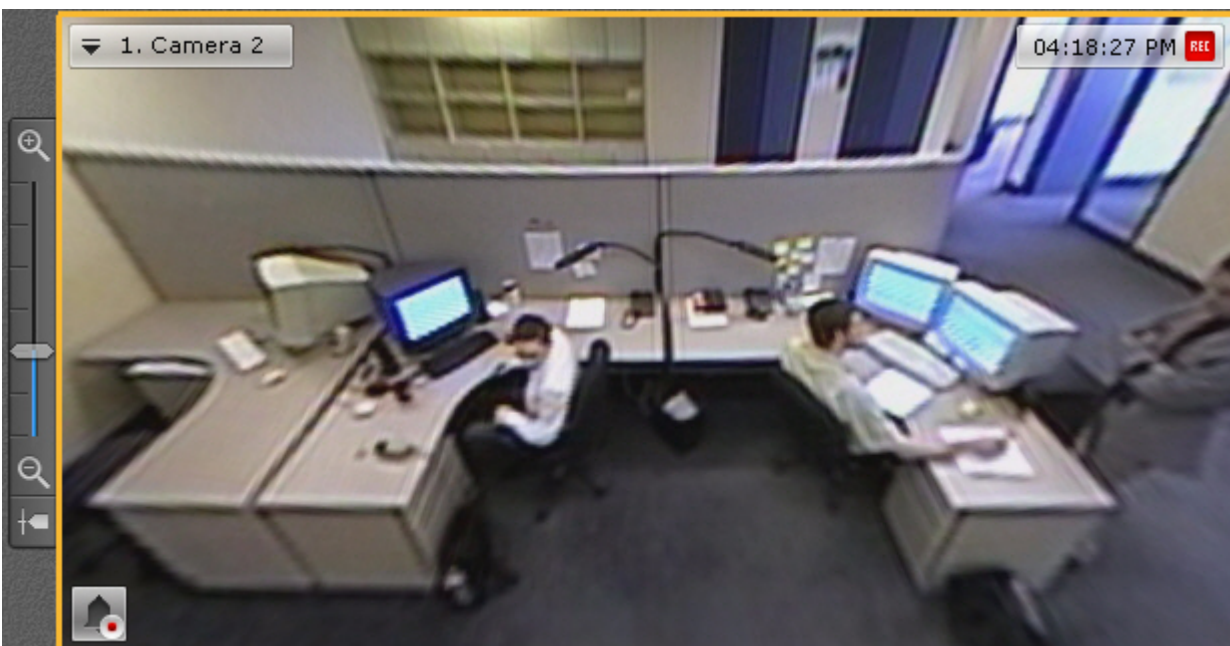

In both viewing modes, all standard video surveillance functions are available for the fisheye camera.

### **180 degree Panorama**

This display type is available only for video cameras that have Immervision lenses.

Video is unfolded (dewarped) into a 180 panorama, with a configurable viewing angle.

**Note**

If the video camera is wall-mounted, the angle of view cannot be configured (see [Configuring fisheye cameras](#)).



To set the viewing angle, click and hold the  button while moving the cursor to the left or right.

Point&Click (see [Control using Point&Click](#)) and all standard video viewing functions are available when viewing video in this format.

## Fisheye cameras on an interactive map

### Viewing video and controlling a fisheye camera from the map

If a fisheye camera is ceiling-mounted (this position is selected in the video camera settings, see [Configuring fisheye cameras](#)) and a 360 field of view is specified for it on the map, the video from the camera is displayed on the map in real time.

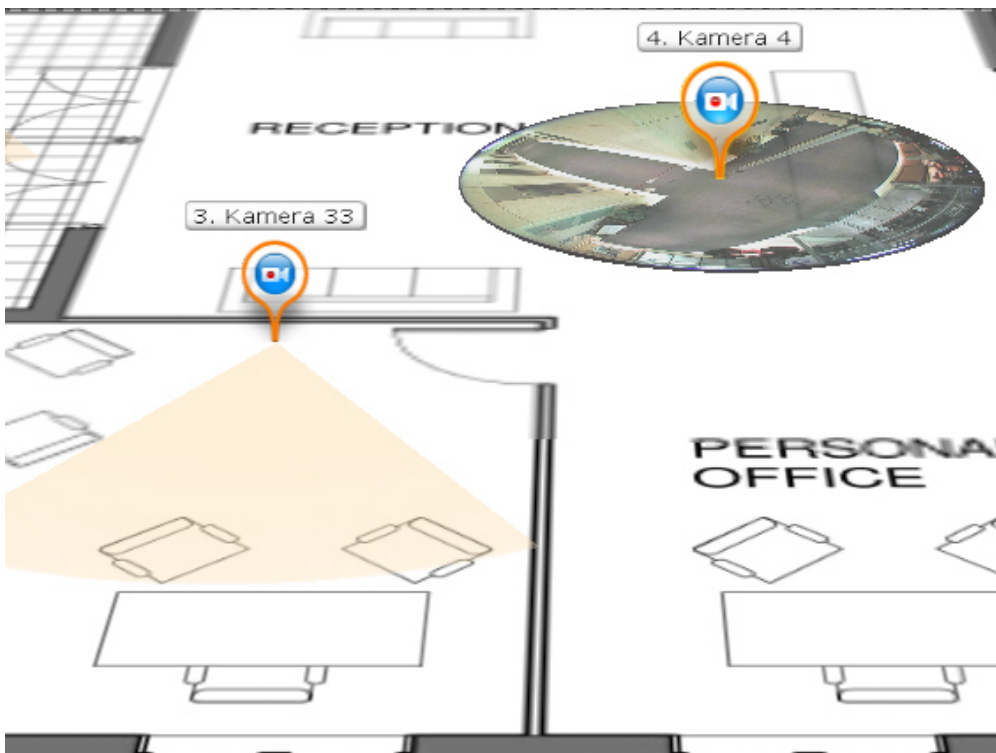

To refocus the angle of view of a fisheye camera so that a chosen point in the viewing tile becomes the center of the frame, left-click that point (this is the Point & Click function, see [Changing the camera lens focus \(Point&Click\)](#)).



**Note**

If the viewing tile for the fisheye camera is inactive when it is clicked, the first click on the video on the map activates the viewing tile. The second click activates the Point & Click function

### Fisheye cameras in immersive mode

In immersive mode (see [Immersive mode](#)), the video from a fisheye camera is displayed on the entirety of the video surveillance screen, above the map display, as virtual telemetry (see [Viewing modes for video from fisheye cameras](#)).



In immersive mode, only the following video surveillance functions are available for fisheye cameras.

1. Digital zoom via mouse scrolling (see [Enlarging a video image using the mouse scroll wheel](#)).
2. Point & Click functionality (see [Changing the camera lens focus \(Point&Click\)](#)).
3. To change the angle of view of a fisheye camera, move the mouse around the video image while holding down the left mouse button.

To exit immersive mode, click the  button.

## Working with information boards



### Attention!

Information boards in version 3.5.0 are available only for [pay & demo license](#) of Axxon Next. This functional will be available in [free versions](#) over 3.5.1.

## Resizing information boards

You can resize information boards in the same way as viewing tiles (see [Scaling the Viewing Tile](#)).



### Note

When the Counter Board is enlarged, the graph is enlarged as well, displaying data for a broader range of time. When the size of the Counter Board is reduced, the opposite occurs.

In both cases, the right-hand border of the graph is constant.

If an information board tile is linked to a viewing tile, at the first enlargement step (to 50%), the viewing tile and information board tile are displayed together and occupy all of the screen on one side.



### Note

In this case, the first step takes into account the total size of the related cells: the related cells must be less than 50% of both sides of the layout

## Hiding information boards

Operators can hide information boards in a layout, if this is allowed in the settings.

To hide an information board, in its upper-right corner, click the  button.

If all cells in the layout have the same size, the space freed up after hiding an information board is allocated to the neighboring cells. Horizontal neighbors have priority over vertical ones.

If free space cannot be distributed horizontally, it is distributed between the vertical neighbors.

In more complicated cases (when cell sizes are different), an attempt is made to distribute the free space between

horizontal neighboring cells. If this is not possible, free space is distributed between vertical neighboring cells. If even this second attempt is unsuccessful due to the layout configuration, the space remains empty.

Hidden information boards are displayed in two cases:

1. After switching to another layout and back to the original one
2. When an event occurs that requires the operator's attention A description of such events for each type of information board is given in the following table.

Types of information boards	Events that trigger board display
Events	An event matching the board filtering settings occurs
Health	Server condition worsens
Counter	New events occur

## Automatically switching to layouts with information boards

Automatic switching to a layout with an information board is possible for Events Boards and Health Boards. This option is available when configuring boards of these types.

Automatic switching to a layout with an Events Board occurs when the following conditions are met:

1. The current layout does not contain an Events Board.
2. An event matching the board filtering settings has occurred in the system.

Automatic switching to a layout with a Health Board occurs when the following conditions are met:

1. The current layout does not contain a Health Board.
2. The status of a monitored server or camera worsens.

The layout with the smallest number of cells is chosen for display. If there are multiple layouts with identical numbers of cells, the layout that comes first in the alphabet is chosen.

## Working with Events Boards

### Options for displaying information on Events Boards

Events Boards display information about selected system events. Configuration of the events to display is performed in the corresponding section.

Events on the board can be displayed in three ways, chosen via the buttons in the upper-left corner of the board:

1. First frame of events and their time

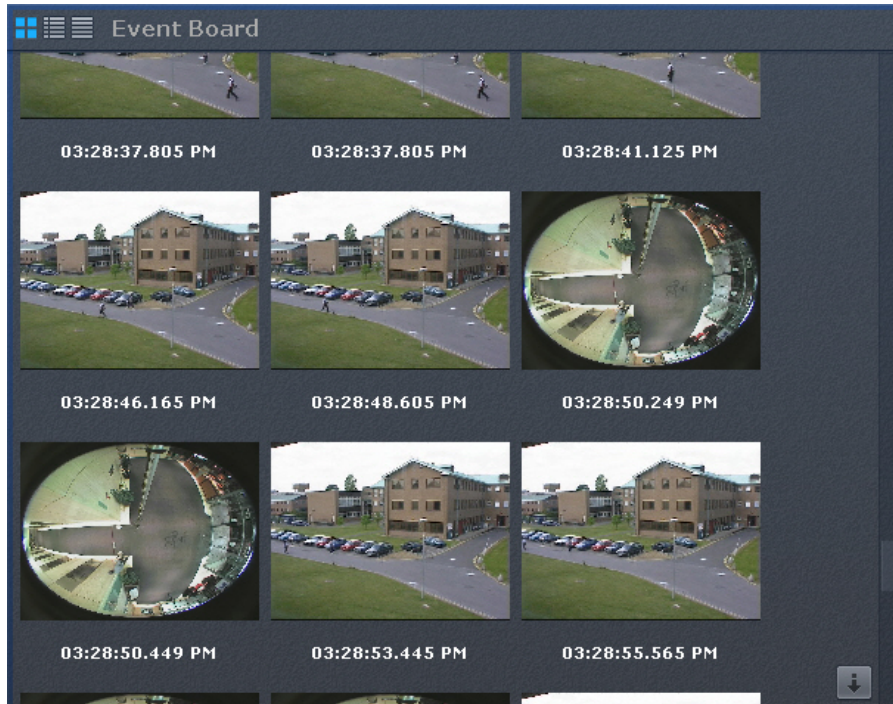

2. First frame of events and text



### 3. Text only

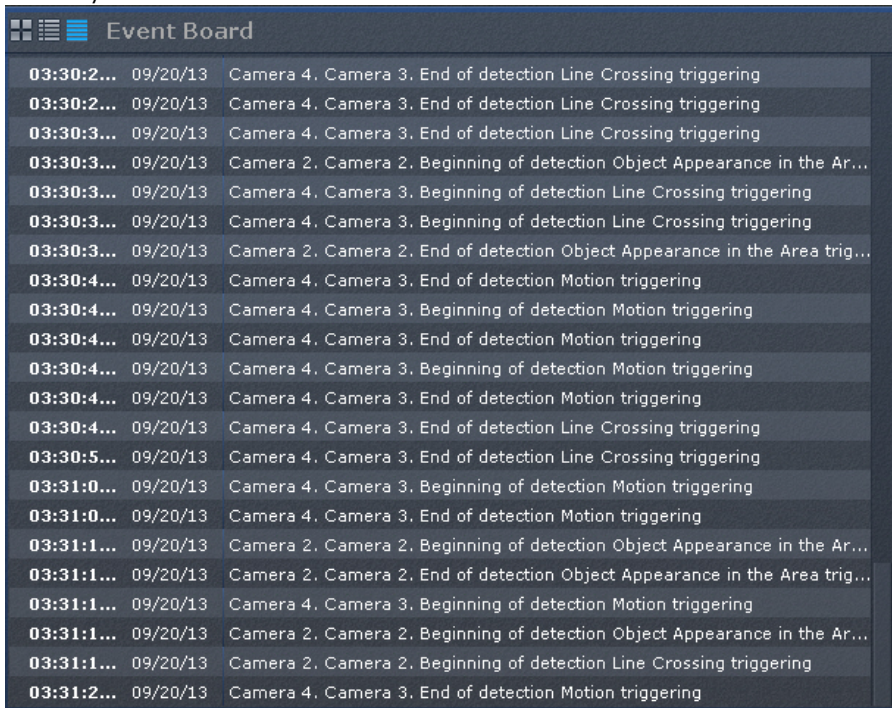

When a layout is switched to, by default the Events Board is displayed as configured in the settings.

## Switching a camera linked to an Events Board to the archives

If an Events Board is linked with a camera, clicking an event will switch the camera to Archive mode at the point in time corresponding to the event.

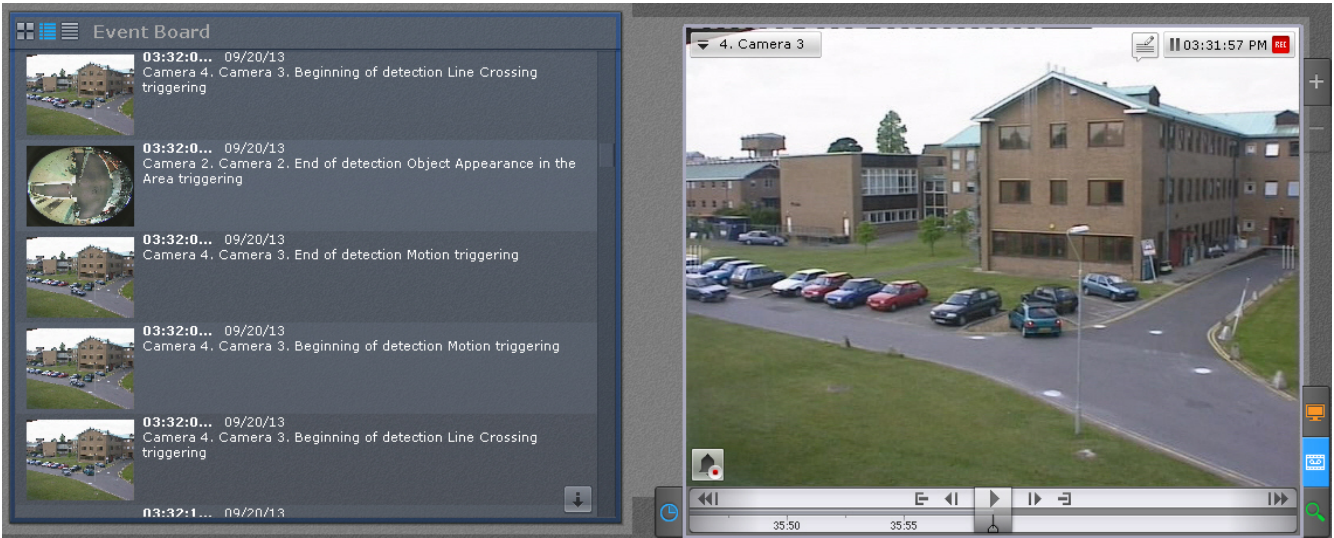

**Note**

If there is no archive for a camera when an alarm occurs, the archive is positioned at the closest recorded archive entry.

**Note**

If an Events Board is linked to several cameras, all cameras transition to Archive mode.

## Working with Health Boards

Health Boards display the status of selected system servers and connected cameras.

If more than one server is monitored, by default the Health Status displays the status of servers when the user switches to the layout.

If only one server is monitored, by default the Health Status displays the status of the server when the user switches to the layout.

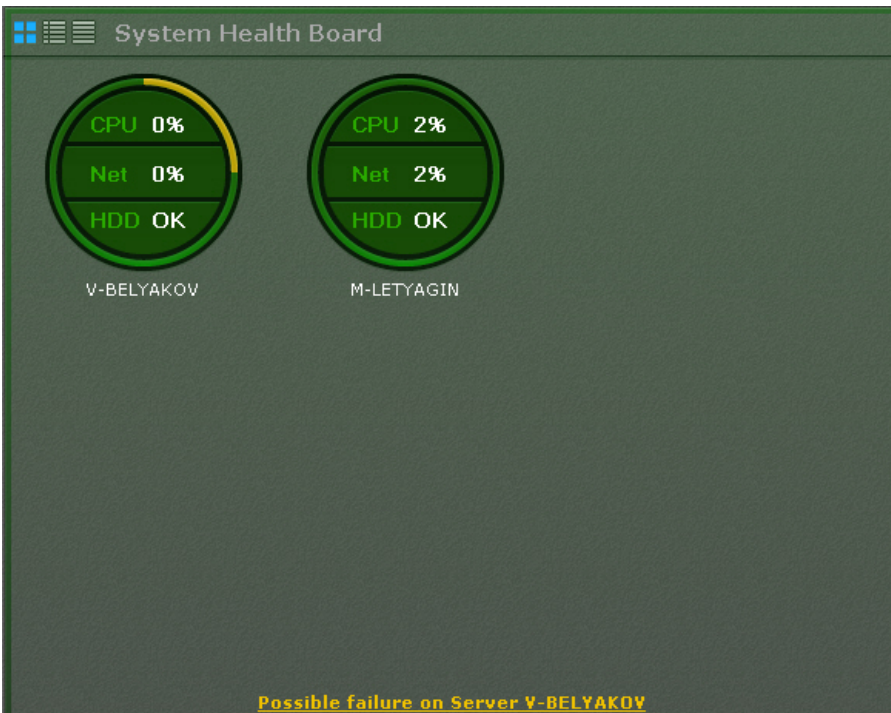

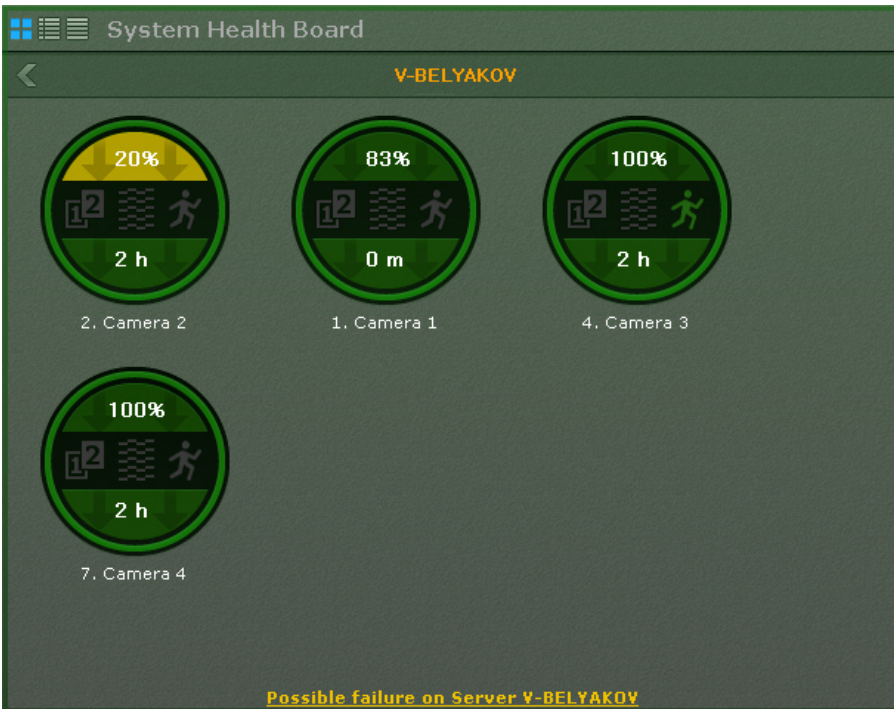

To switch to viewing the status of cameras, click the diagram for the relevant server.

**Note**  
In table mode, you can view server status by clicking the relevant line in the table.

To switch to a view of server status, click the  button.

### Viewing server status

Information about the status of servers can be displayed in three ways, chosen via the buttons in the upper-left corner of the board:

1. as diagrams

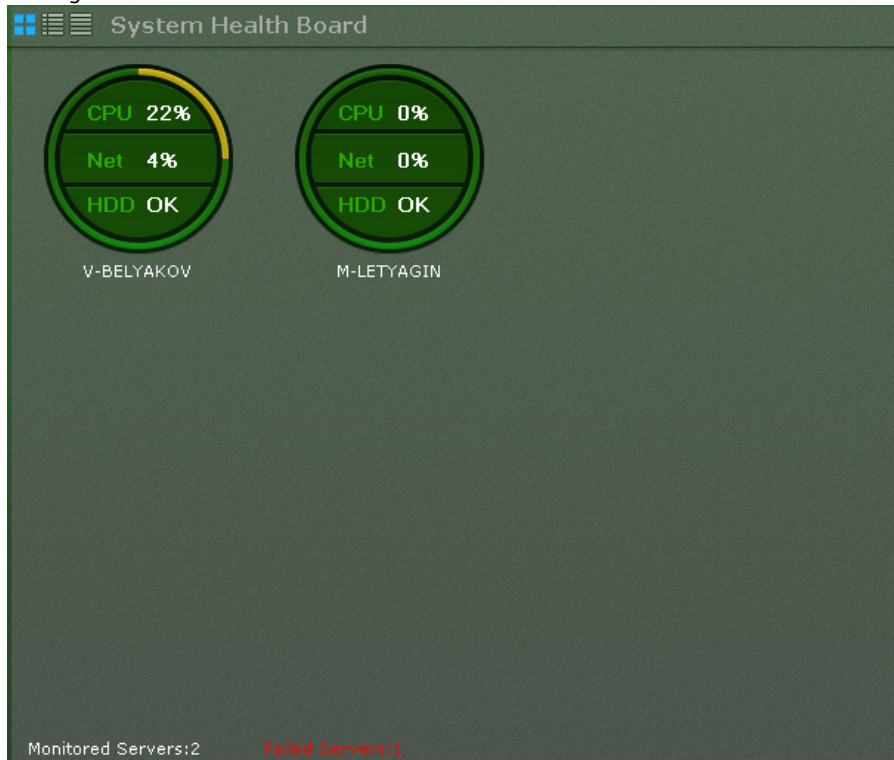

2. as diagrams with text

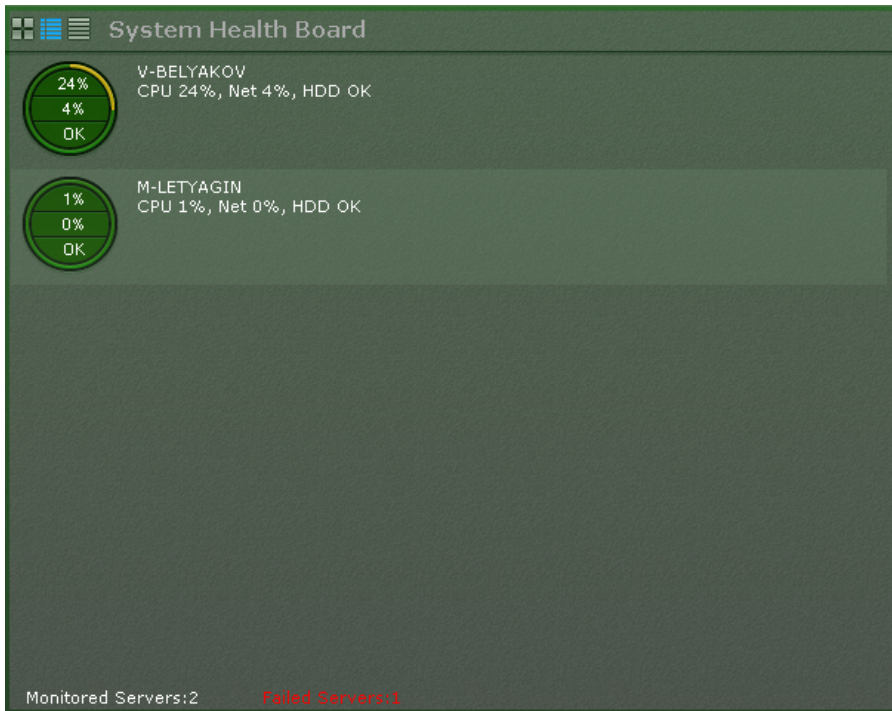

3. as a table



Tables can be sorted by any column in any direction.

The following components are monitored for each server; CPU load, network use, and status of the hard disk subsystem.

Areas of the diagram change color based on the respective status.

	<b>CPU</b>	<b>Network</b>	<b>HDD</b>
Red	Load >95%	Connection failure	Critical load on the disk subsystem, some data may be lost
Yellow	Load from 85% to 94%	At 70% to 100% of capacity	Elevated load on the disk subsystem, without data losses
Green	Load <85%	At less than 70% of capacity	Normal functioning of the disk subsystem (proper operation)

The edge of the diagram changes color based on the status of the connected cameras (see [Viewing camera status](#)).

If the entire edge is green, all cameras are in normal condition. If part of the edge is yellow or red, some cameras have borderline or critical status.

Overall server status is determined from the above parameters as follows:

1. Normal – all components and cameras are normal.
2. Borderline – possible problems with the status of at least one component or camera.
3. Critical – at least one component or camera is in critical condition.

Server information is updated every ten seconds.

If the connection to a server is lost, a corresponding icon is used to depict it.



If all servers are in normal condition, the bottom of the board displays a status bar with information about the number of monitored and distressed servers.

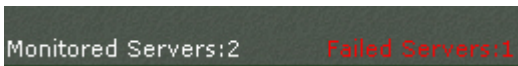

If the status of any server worsens, the status bar is replaced by a message. When the message is clicked, the server status is displayed (if the board is currently displaying camera status).

**Critical state of Server V-BELIAKOV**

The message then closes and the status bar again appears.

**Note**  
If the status of several servers worsens, a message is shown for the last one.

## Viewing camera status

Information about the status of cameras can be displayed in three ways, chosen via the buttons in the upper-left corner of the board:

1. as diagrams

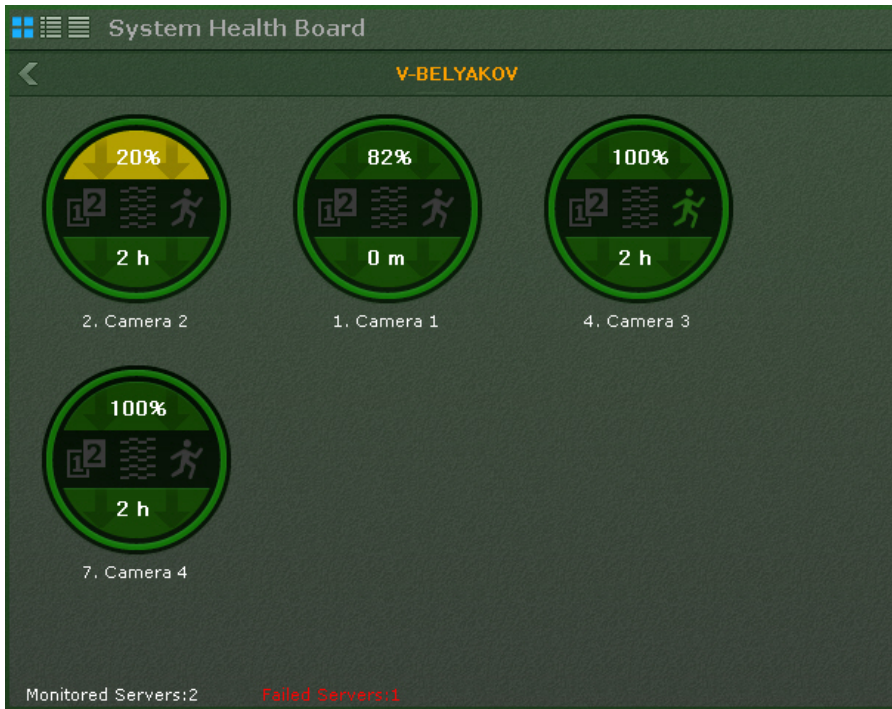

2. as diagrams with text

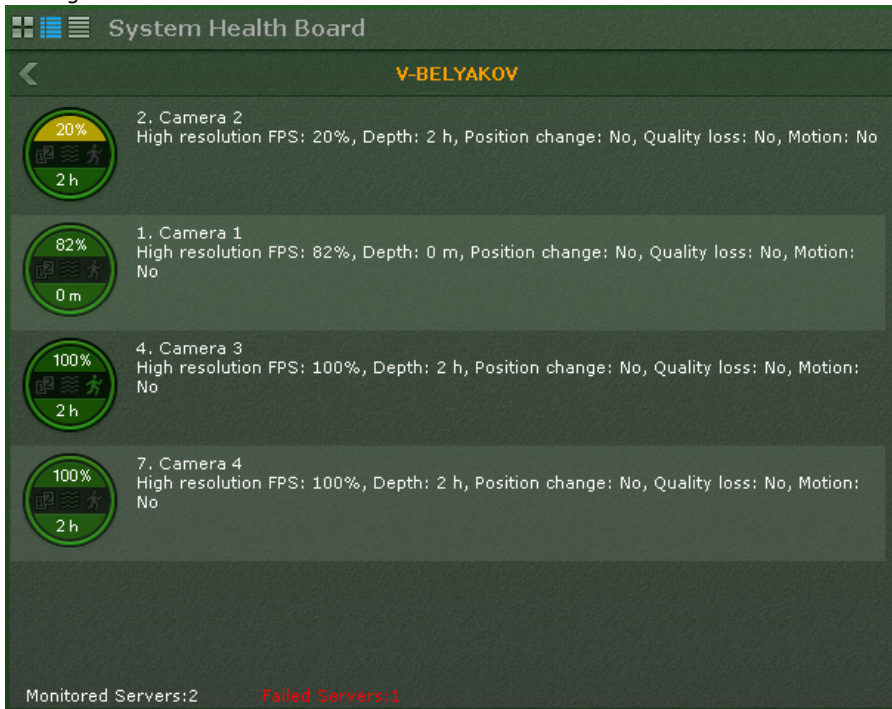

3. as a table

System Health Board

V-BELYAKOV

High resolu...	Depth	Quality loss	Motion	Position change	Camera
20%	2 h	No	No	No	2. Camera 2
82%	0 m	No	No	No	1. Camera 1
100%	2 h	No	No	No	4. Camera 3
100%	2 h	No	No	No	7. Camera 4

Monitored Servers:2 Failed Servers:1

Tables can be sorted by any column in any direction.

The following information is displayed for each camera:

1. The frame rate (fps) set for the high-quality stream of the camera divided by the fps for the video actually received, as a percentage (frame rate % to max)
2. Status of detection tools (loss of quality, position change, motion)
3. Maximum stored recorded video (if archive recording is not configured for the camera, this section is colored gray on the diagram)

The camera status is measured based on the signal from the camera and stream rate:

1. Normal – camera signal present, frame rate & to max from 70% to 100% The camera is colored green on the diagram and in the table.
2. Borderline – camera signal present, frame rate & to max from 20% to 70% The camera is colored yellow on the diagram and in the table.
3. Critical – no camera signal or frame rate & to max is less than 20% The camera is colored red on the diagram and in the table.

Information is updated every ten seconds.

If there is no signal from a camera, the appearance of the diagram changes accordingly.

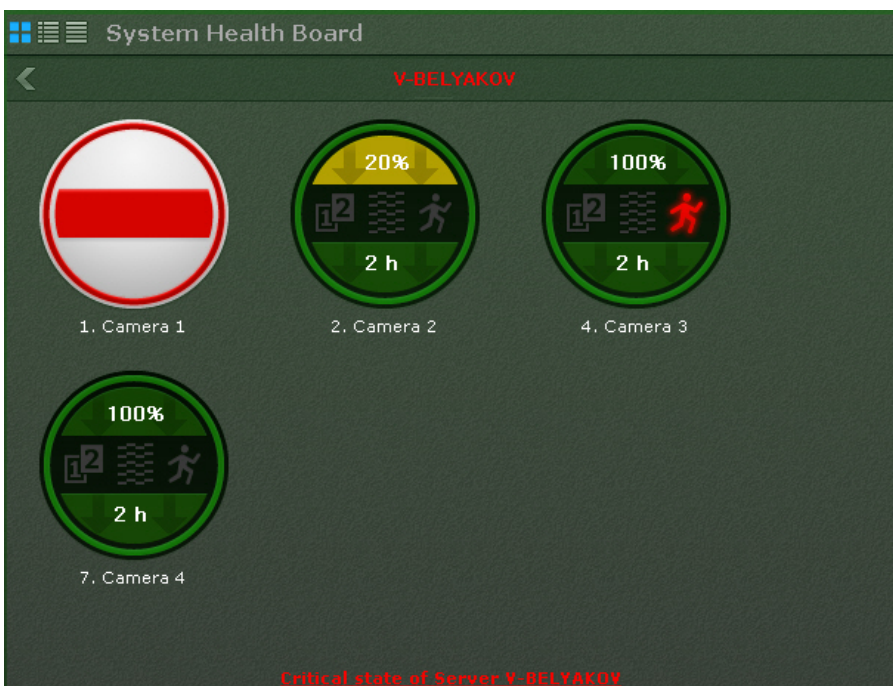

Information about detection tools is received in real time. Depending on the status of detection tools, the corresponding icons change color:

- Green – detection tool status is normal
- Red – detection tool activated
- Gray – detection tool disabled

## Working with Statistics Boards

The Statistics Board is a graph of the number of events of a certain type for a specified timeframe. The type of events and amount of time between the points of the graph are configured in the board settings (see [Configuring a Statistics Board](#)).

The points of the graph change over time and depend on the current time and interval specified in the settings.

The points are calculated every minute/hour/day/etc. based on the selected unit of measurement (if the interval is specified in minutes, then every minute; if specified in hours, then every hour, and so forth) and is performed as follows:

1. The current time (last point on the graph) is rounded to the nearest whole unit of time (if the interval in the settings is specified in minutes, then the nearest whole minute; if specified in hours, then the nearest whole hour, and so forth).
2. This rounded time is used as the next-to-last point.
3. The formula for the other points is as follows: the adjacent point to the right, minus the interval of time specified in the settings.

For example, the interval is set to **10 minutes** on this sample graph here. The current time (**1:07:33 p.m.**) is the last point on the graph, so after rounding this to the next whole minute we get the value for the next-to-last point: **1:07:00 p.m.** Correspondingly, the points before it are **12:57:00 p.m.**, **12:47:00 p.m.**, etc.

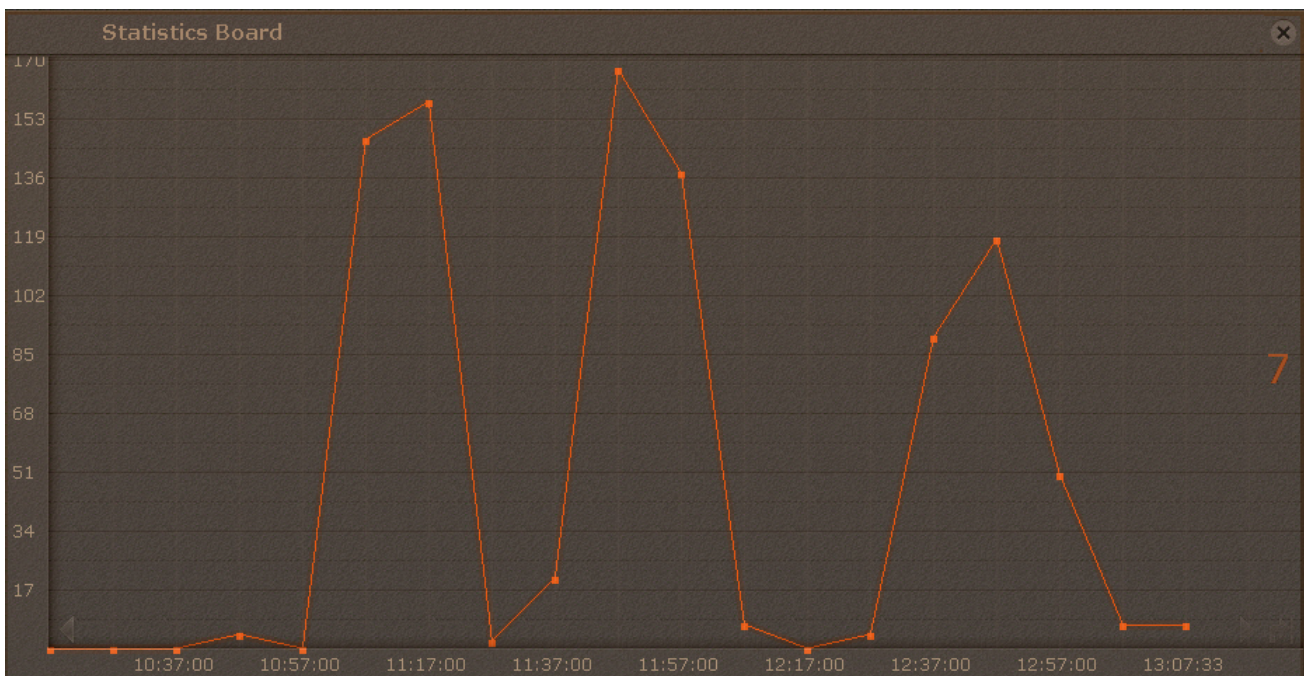



When the current time becomes **1:08:00 p.m.**, the points will be updated to **12:58:00 p.m.**, **12:48:00 p.m.**, etc.

The graph displays the current number of events. The number of events is recalculated every minute and does not depend on the interval chosen.

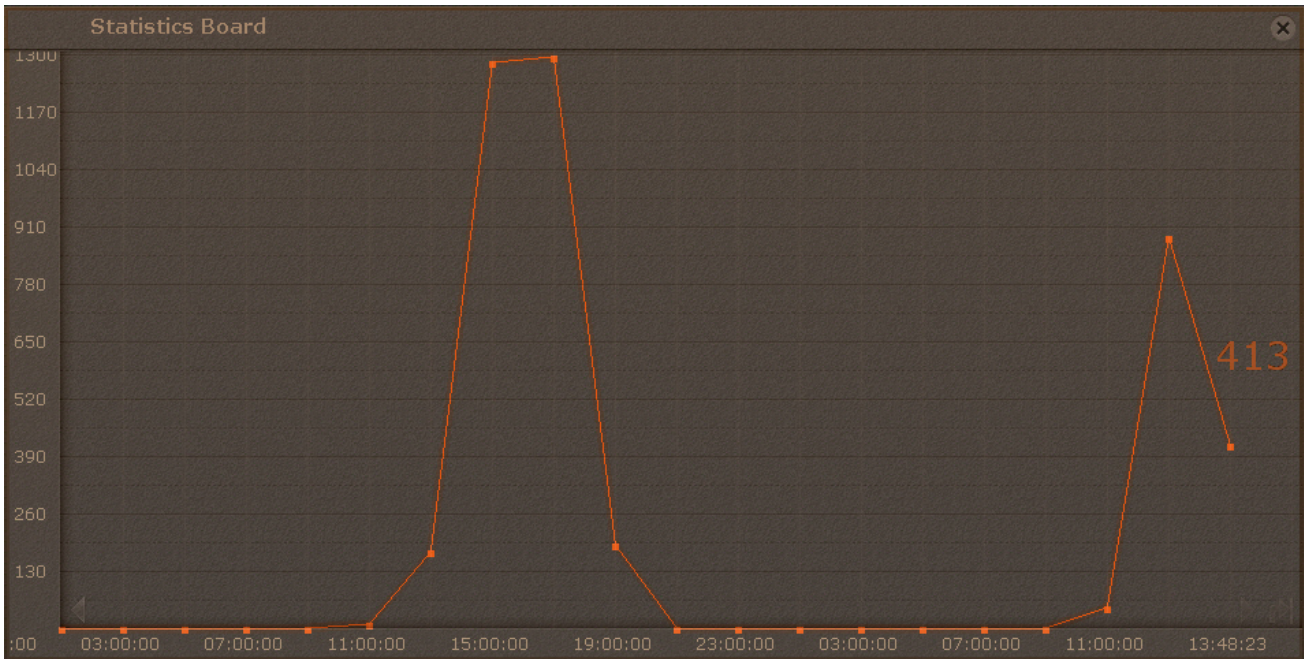
For example, for this graph with a time interval of **2 hours** and a current time of **1:48:23 p.m.**, the current number of events equals **413**, for the period from **11:48:00 a.m.** to **1:48:00 p.m.**



To scroll through the graph, use the arrows  on the graph edges. To jump to the last point on the graph, click the  button.

Clicking anywhere on the graph jumps to the nearest point and the relevant value is indicated.

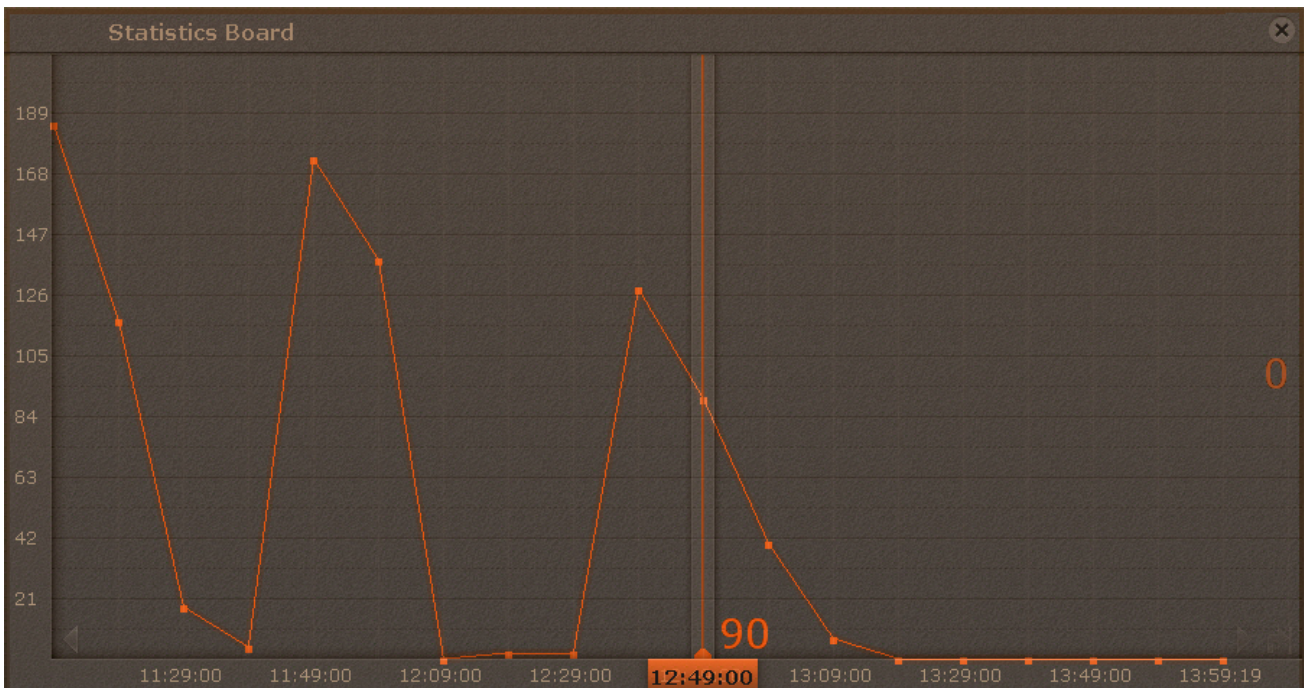

## Audio Monitoring

### General Information

Audio monitoring of a situation is carried out using the microphones that correspond to a video camera surveying the situation.

In different viewing tile modes, different audio monitoring functions are accessible:

1. Live playback mode – listening to sound from a microphone in real time.
2. Archive mode, Alarm Management mode, Archive Search mode– playback of sound recorded from a microphone.

#### Note

In Archive mode and Archive Search mode, an audio recording can be played back only from the microphone corresponding to the currently selected video camera, and only in forward playback mode at a speed of 1x.

## Activating audio monitoring



### Attention!

The **Microphone** object must be enabled (see the section titled [The Microphone Object](#)).

To activate audio monitoring in any surveillance mode, left-click the speaker icon in the viewing tile.



The volume icon and volume adjuster now become active.



## Volume control

Volume is controlled in any surveillance mode using the volume adjuster

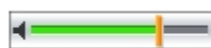

### Note

The volume adjuster must be active.

The far left position of the adjuster represents the minimum volume, and the far right position represents the maximum volume.

## Working with the Interactive Map

You can use the interactive map in three modes;

1. 3D mode, in which both the map and layout are available
2. 2D mode, in which only the map is available
3. immersion mode, in which video is overlaid on the map

The map can contain icons for cameras, relays, and sensors. The area in which live video is displayed and field of view are indicated for each camera.

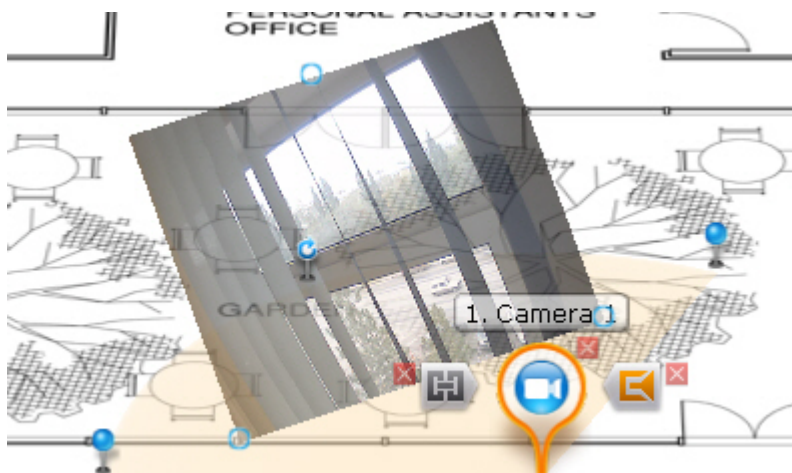

## Opening and closing the map

You can switch to Map View from all modes of operation except for Archive Search.

To go to Map View, point the cursor at the pop-up **Map** button and click it.



The Map will open in a 3 D view while the current layout contracts to fit the screen area over the map.

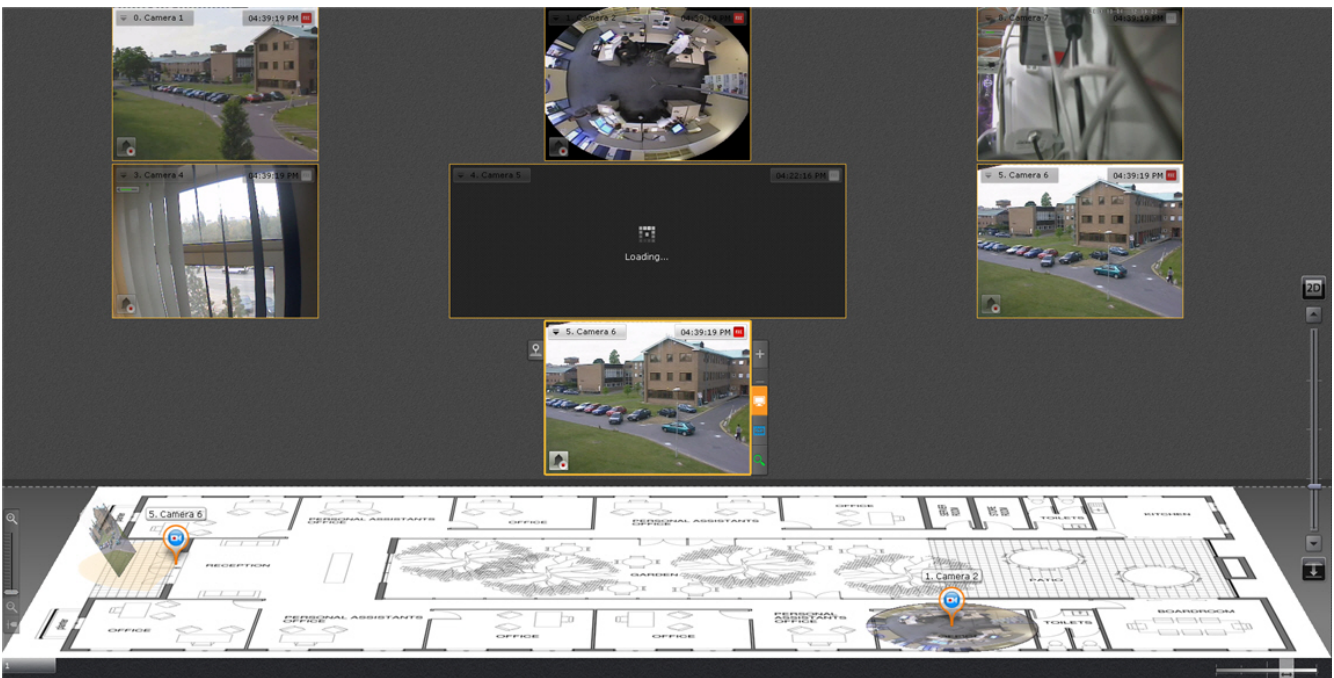

To exit Map View click

## Changing the map tilt

You can change the tilt of the map in any mode.

You can change the tilt of the map in one of two ways:

1. By using the slider or buttons for adjusting tilt **(1)**.
2. By adjusting the border of the area of the map and the layout **(2)**.

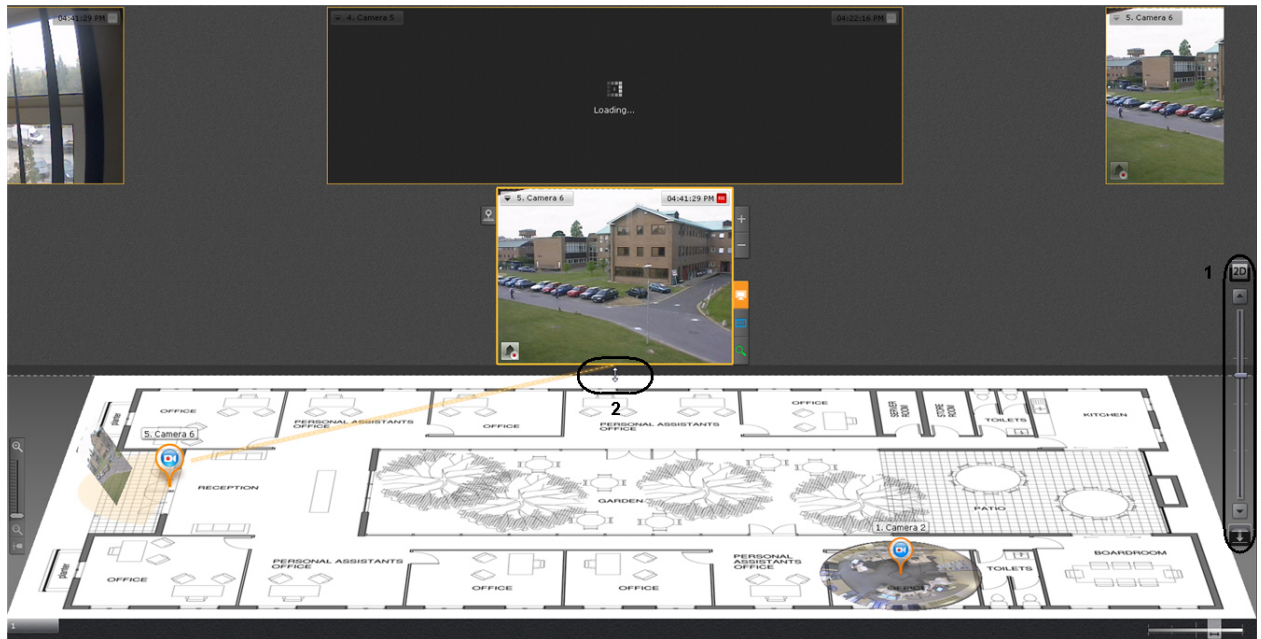

To switch to 2D map viewing mode and close the layout, select the  button.

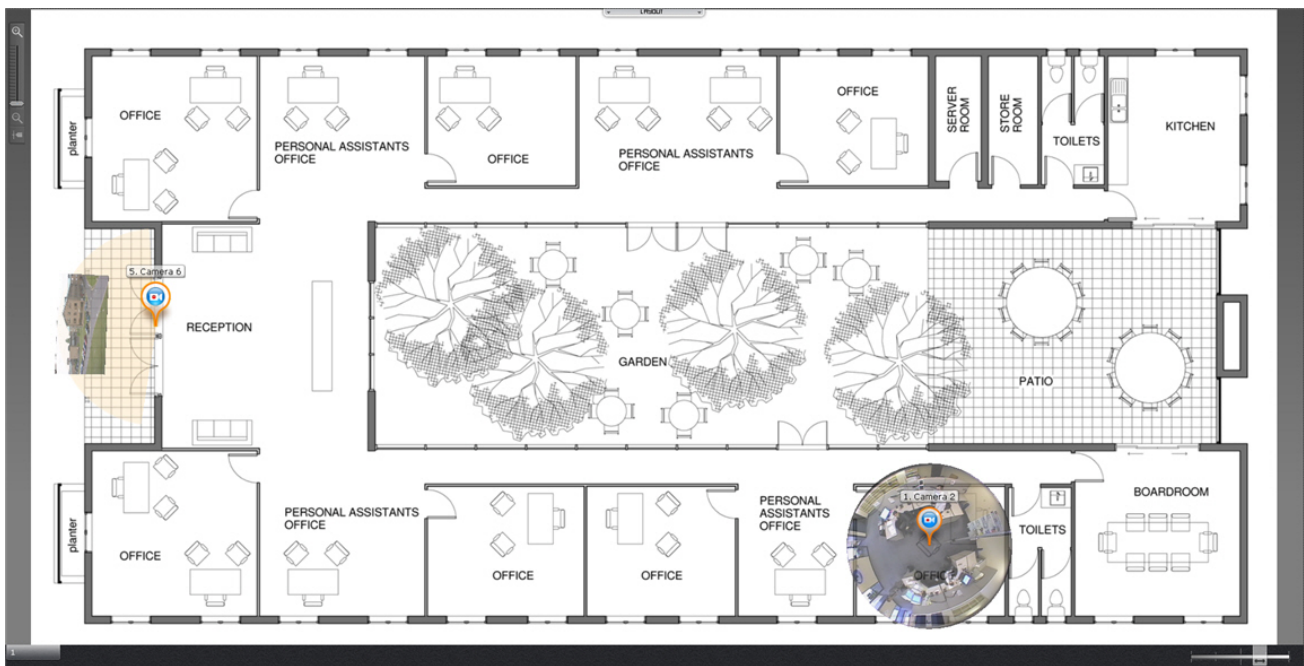

To return to the layout, point the cursor at the pop-up **Layout** button and click it.

## Scaling and focusing of map

Map scale and focus can be changed both manually and automatically.

### Note

The map is automatically resized and refocused if this function is activated in the settings (see [Configuring map autozoom](#)).

Automatic adjustment of map scale and focus occurs when a video camera alarm occurs, if no video camera icon is selected on the map.

In this case, the map is scaled and refocused to center the icon for the alarm camera on the map.

If alarms occur for several video cameras simultaneously, the map scale and position are adjusted to show all icons for the relevant video cameras.

After a video camera alarm ends and there are no alarms for other video cameras, the map scale and position return to

their initial status.

Automatic scaling and focusing of the map stops during the following actions:

When the user clicks to select the icon of a video camera on the map or viewing tile

To manually adjust the map scale, use the mouse scroll wheel (the cursor must be above the map) or use the map scale slider.

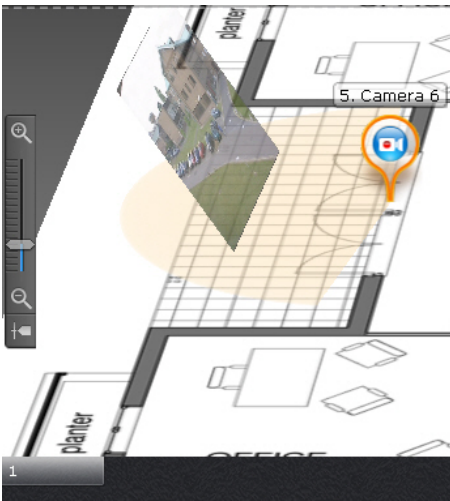

After increasing the scale, you can refocus the map with the mouse (by clicking and holding the left mouse button) in the direction of your choice.

## Adjusting transparency of map video

To change the transparency of video on the map, use the slider in the lower-right corner.



If the slider is in the far left position, the video is not displayed on the map. If the slider is in the far right position, the video is opaque.

## Immersive mode

In immersion mode, video from a selected camera is overlaid on the map display.

If links have been created between video and the map (see [Configuring cameras in immersion mode](#)), an angle will be chosen so that objects in the video match the objects as depicted on the map.

If links have not been created, the map is shown so that the video is located in the field of view specified for the camera on the map. The field of view is oriented upwards.

To switch to immersion mode, click the  button on the left border of the viewing tile or, on the map, left-click a video icon, field of view, or video display area.

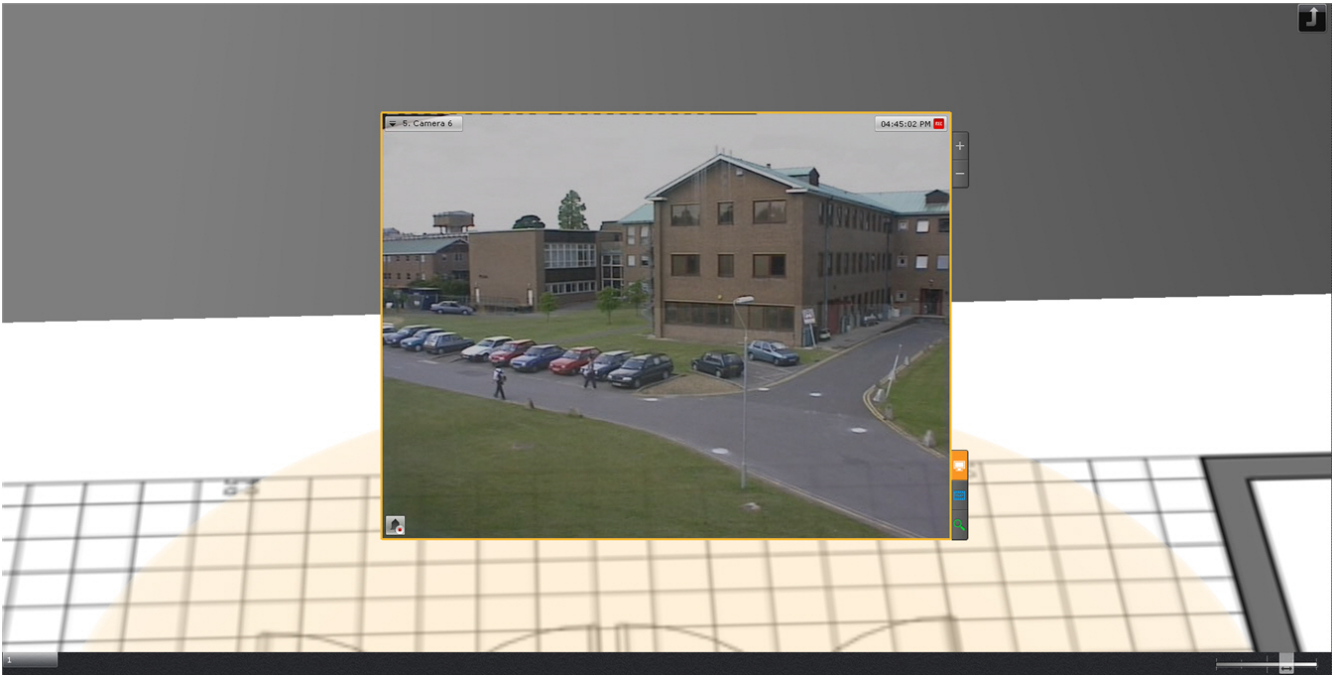



In immersive mode you can view video from only one video camera at a time.

To select another video camera, do one of the following:

1. Click the video camera icon or its field of view on the map, if possible.
2. Exit immersive mode and select the necessary video camera on the map.

To exit immersive mode, do one of the following:

1. Click the  button.
2. Minimize the viewing tile by clicking the  button.
3. Click a part of the map that does not contain the camera field of view.

**Note**

Actions 2 and 3 do not apply if a fisheye camera is in immersive mode (see [Fisheye cameras in immersive mode](#))

## Switching between maps

In any mode, you can switch between the maps that have been created in the system.

You can switch between maps in two ways:

1. In the lower-left corner of the screen, select the corresponding tab

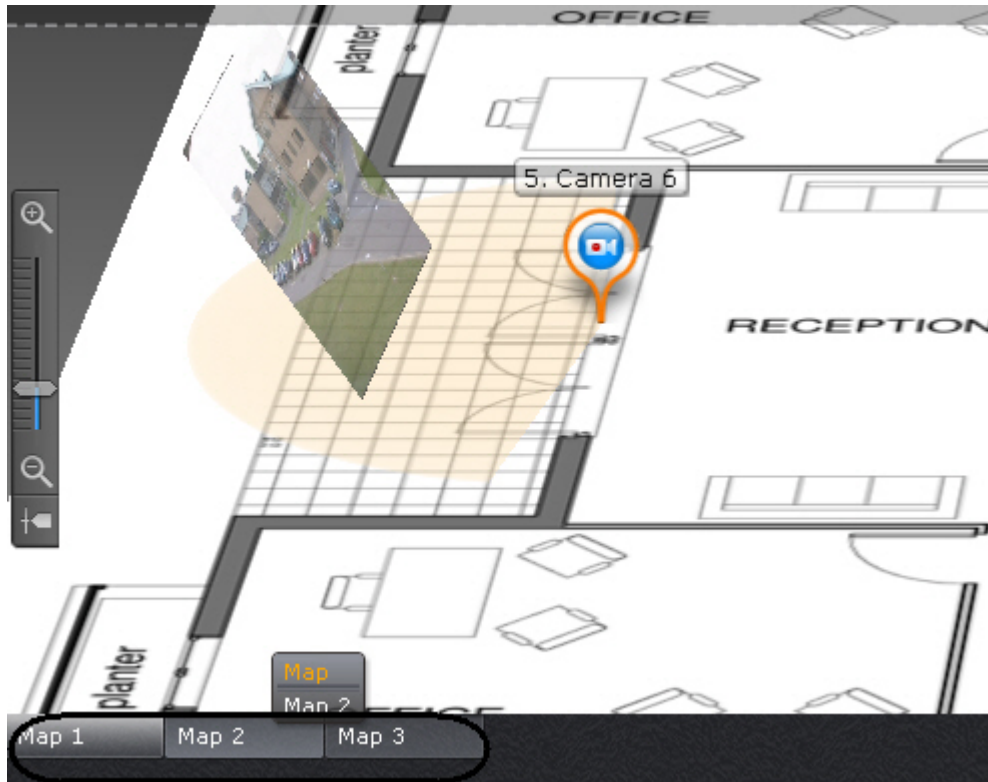

**Note**

If many maps have been created, some tabs may not fit on the screen. If this happens, click the  button on. In the drop-down menu that opens, select a map.

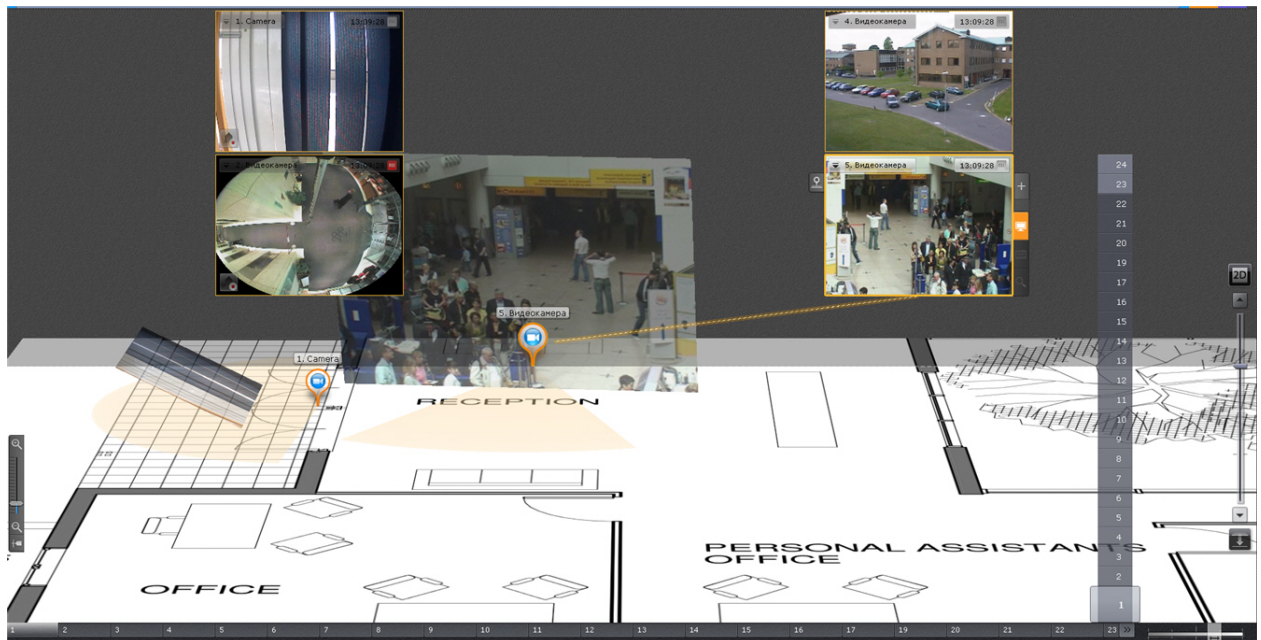



- By left-clicking a map icon for switching, if it has been created (see [Adding switches to another map](#)). The icon header shows the name of the destination map.





## Controlling devices from the map

You can manage devices on the map (video cameras, relays) by using the context menus of the corresponding icons. You can control devices in all modes.

Commands for controlling video cameras are given in the table below.

Command (context menu item)	Condition	Icon status after the command is performed
Arm	The camera is disarmed	
Disarm	Camera armed	





Commands for controlling relays are given in the table below.

Command (context menu item)	Condition	Icon status after the command is performed
Turns the relay on	Relay in normal status	
Disable relay	Relay is activated	



## Displaying device status

The icons on the map indicate the current status of the corresponding devices.

The table below possible status states of the video camera icon are described in the following list.

Map icon	Camera status
	Camera disarmed, no archive recording
	Camera disarmed, archive recording active
	Camera armed, no archive recording
	Camera armed, archive recording active
	Camera alarm, archive recording active

The table below possible status states of the relay icon are described in the following list.

Map icon	Relay status
	Relay is activated
	Relay in normal status

The table below possible status states of the sensor icon are described in the following list.

Map icon	Sensor status
	Video camera is armed, sensor is in normal status
	Video camera is armed, sensor is in alarm status
	Video camera is disarmed, sensor is in normal status
	Video camera is disarmed, sensor is in alarm status

## Exporting Frames and Video Recordings

### Frame export

Export of frames is accessible in all viewing tile modes.

To export a video image frame, you must perform the following steps:

1. Enable the **Snapshot** function (see the section titled [Using the Snapshot function](#)) if video surveillance is in real time, or stop playback, if video surveillance is in any other mode.



**Note**

You do not need to enable the **Snapshot** function to export a frame while paused in the archive (in Alarm Management mode or archive mode).

2. Bring up the context menu in the viewing tile (**1**).
3. Select **Export snapshot** (**2**).



4. The snapshot will then be saved in .JPG format in the directory specified in the export settings (see the section titled [Configuring export](#)).

Export of the frame is now complete.

A digital signature is added to exported frames. Digital signatures are verified using the corresponding utility (see [Digital Signature Verification Utility](#)).



[Play corresponding video](#)

### Exporting Video Recordings

Video export is available in archive and archive analysis modes.

To export a video recording (fragment):

1. Go to archive mode or archive analysis mode (see the sections [Switching to Archive Mode](#) and [Switching to Archive Search mode](#)).
2. Select the video fragment that you want to export using one of the following methods:
  - a. Set the export interval on the main timeline: set the timeline indicator to the location that matches the

beginning of the export interval. Click the  button. Set the indicator to the location that matches the end of the export interval and click . You can also select the export interval by using the right mouse button. To clear the interval, click the  button

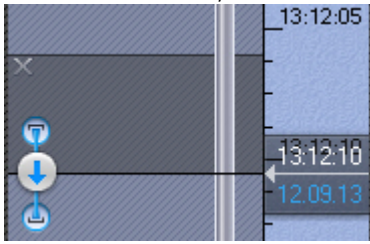

- b. Set the export interval on the extra archive navigation panel. This process is the same, but the export interval cannot be set by the right mouse button. To clear the interval, click the  button.



- c. Set the export interval by using the context menu of the viewing tile: select the **Set range ->Set beginning of range (2)** menu item to set the indicator of the primary or secondary timeline in the position that matches the beginning of the export range; then select the **Set range ->Set end of range (3)** menu item to set the indicator of the primary or secondary timeline in the position that matches the end of the export range To remove the interval, select the **Set range ->Deselect range (4)**



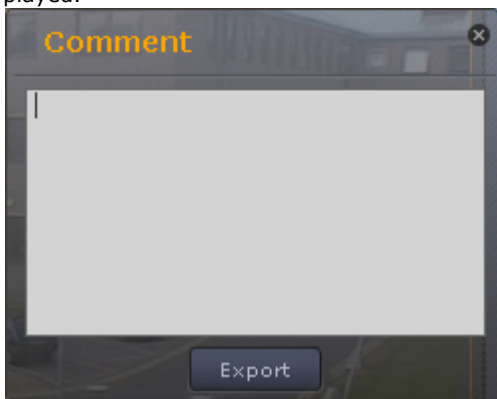

3. Click the  button or select the **Set range ->Export video (1)**.  
 4. If necessary, add comments for the export. The comments will be shown as captions when the exported video is played.





5. Click the **Export** button.

The export process begins. Its status is shown in a message below the layouts ribbon.



If several export processes are ongoing, use the   buttons to switch between them. The following information is displayed between them: number of the current export operation / total number of export operations (export progress for all operations). To cancel a current export, click the  button.

When an export operation finishes, the selected video fragment is saved in .mkv format in the folder (to open this folder,

click the  button; to close the export notification, click the  button) that was specified in the export settings (see [Configuring export](#)). Titles containing a date and time stamp will be superimposed on video from that footage.

**Note**  
Captions are stored in a separate video track and, if necessary, are disabled in the player through software

To close all export notifications, click the  button.

Export of the video recording is now complete.  
A digital signature is added to exported video. Digital signatures are verified using the corresponding utility (see [Digital Signature Verification Utility](#)).

**Note**  
A list of software that supports the .mkv format is available [here](#).

[Play corresponding video](#)

## Event Control

Event control in the Axxon Next software package can be conducted in three ways:

1. In Live Video mode
2. Using the system log
3. By logging events in external logs

**Note**  
Configuration of logging to external files is carried out through the log management utility (see the section [Log Management Utility](#)).

[Play corresponding video](#)

## Control in Live Video Mode

Messages about system errors which have occurred are displayed in real time on a dynamic error panel. When there are no unaccepted errors, this panel is not displayed; when there are such errors, it is displayed in Axxon Next's **Layouts** and **Alarms** tabs.

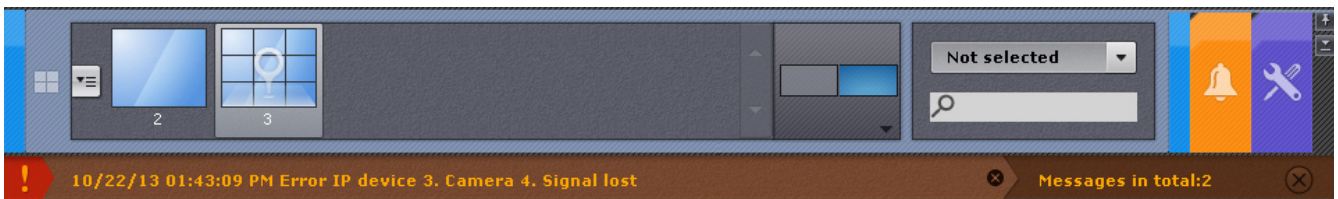

**Note**  
This feature is configured on the **Settings** tab (see the section [Configuring Display of Error Messages](#)).

To accept an error and delete it from the error panel, click the corresponding  button.

To accept all errors and close the error panel, click the button

 Total messages:1

## The System Log

Information about events which have occurred in the system is stored in the system log.

To access the system log, select **Settings** -> **System log** .



When you do this, a window appears which can be used to search, view, and export system log events.

## Setting Event Search Filters

To view and/or export system log events, first you need to perform a search for them.

To search for system log events, you need to set one or more filters:

1. Time period during which the events were recorded.
2. Event type:
  - a. Information
  - b. Alarm
  - c. Error
  - d. Debug
3. A key phrase contained in the system event descriptions.



### Note

The time period is a mandatory filter, while the event type and key phrase are optional.

Search filters can be set as follows:

1. In the **To** and **From** fields (1) you can enter the date and time of the beginning and end of the period during which the events you are searching for were recorded.



### Note

The date format is DD-MM-YYYY and the time format is HH:MM:SS.XXX.



### Note

By default, the event search period is defined as the past 24 hours.

2. Select the type of event to search for in the **Event type** list (2). To search for all event types, select an empty line.
3. In the **Search** field (3) enter a key phrase which is in the system description of the events that you want to find.



### Note

If you want to filter for alerts of a particular status, in the **Search for** field, enter the relevant status: **Critical**, **Non-critical**, **False** or **Unclassified**.



### Note

For more precise searching, enter an exact phrase in the **Search keyword** field.

The event search filters have been set.

Next you must start the event search (see the section titled [Event search procedure](#)).

## Event search procedure

To start a search for system log events which satisfy the filters which have been set (see the section [Setting Event Search Filters](#)), click the **Search** button (1).

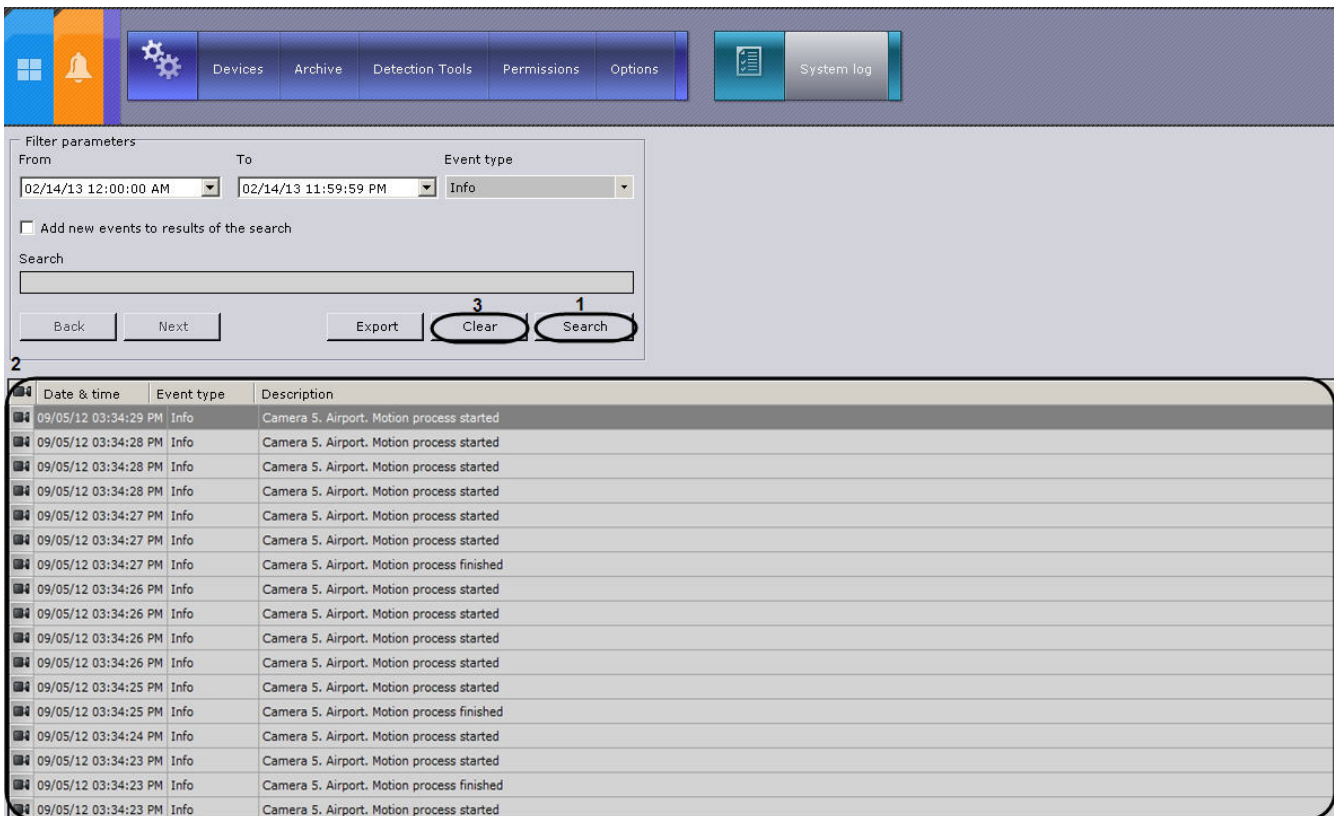

The screenshot shows the event search interface. At the top, there is a navigation bar with icons for Windows, a bell, and a gear, followed by menu items: Devices, Archive, Detection Tools, Permissions, Options, and System log. Below this is the 'Filter parameters' section, which includes 'From' (02/14/13 12:00:00 AM), 'To' (02/14/13 11:59:59 PM), and 'Event type' (Info) dropdown menus. There is a checkbox for 'Add new events to results of the search' and a 'Search' input field. Below the search field are buttons for 'Back', 'Next', 'Export', 'Clear' (circled with a '3'), and 'Search' (circled with a '1'). A table of search results is shown below, with a '2' indicating the table's appearance. The table has columns for 'Date & time', 'Event type', and 'Description'. The results are sorted by date and time, with the most recent at the top.

Date & time	Event type	Description
09/05/12 03:34:29 PM	Info	Camera 5. Airport. Motion process started
09/05/12 03:34:28 PM	Info	Camera 5. Airport. Motion process started
09/05/12 03:34:28 PM	Info	Camera 5. Airport. Motion process started
09/05/12 03:34:28 PM	Info	Camera 5. Airport. Motion process started
09/05/12 03:34:27 PM	Info	Camera 5. Airport. Motion process started
09/05/12 03:34:27 PM	Info	Camera 5. Airport. Motion process started
09/05/12 03:34:27 PM	Info	Camera 5. Airport. Motion process finished
09/05/12 03:34:26 PM	Info	Camera 5. Airport. Motion process started
09/05/12 03:34:26 PM	Info	Camera 5. Airport. Motion process started
09/05/12 03:34:26 PM	Info	Camera 5. Airport. Motion process started
09/05/12 03:34:26 PM	Info	Camera 5. Airport. Motion process started
09/05/12 03:34:26 PM	Info	Camera 5. Airport. Motion process started
09/05/12 03:34:25 PM	Info	Camera 5. Airport. Motion process started
09/05/12 03:34:25 PM	Info	Camera 5. Airport. Motion process finished
09/05/12 03:34:24 PM	Info	Camera 5. Airport. Motion process started
09/05/12 03:34:23 PM	Info	Camera 5. Airport. Motion process started
09/05/12 03:34:23 PM	Info	Camera 5. Airport. Motion process finished
09/05/12 03:34:23 PM	Info	Camera 5. Airport. Motion process started

When you do that, a search results table appears (2).

To accept all errors and close the error panel, click the **Clear** button (3).

## Refreshing Event Search Results

You can automatically refresh the event search results table, i.e., add events to it which happened after the search was started (see the section [Event search procedure](#)). To do this, select the **Add new events to the results of the search** checkbox.

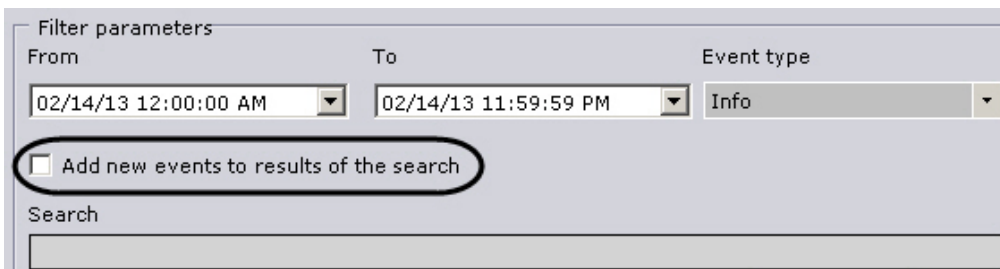

The screenshot shows the 'Filter parameters' section of the event search interface. The 'From' (02/14/13 12:00:00 AM), 'To' (02/14/13 11:59:59 PM), and 'Event type' (Info) dropdown menus are visible. The checkbox for 'Add new events to results of the search' is circled with a '3', indicating it should be selected to refresh the results.

## Viewing Event Search Results

System log event search results are displayed in a table (1).



### Note

Events in the table are sorted by the date they were registered, beginning with the most recent one.

The screenshot shows the system log interface. At the top, there are navigation tabs: Devices, Archive, Detection Tools, Permissions, Options, and System log. Below the navigation is a 'Filter parameters' section with 'From' (02/14/13 08:00:00 AM), 'To' (02/14/13 11:59:59 PM), and 'Event type' dropdown menus. A search box contains the number '2'. Below the search box are 'Back', 'Next', 'Export', 'Clear', and 'Search' buttons. The main area displays a table of search results with columns for Date & time, Event type, and Description. The table contains 20 rows of event logs, all from Camera 5 at the Airport, with descriptions like 'Motion process started' and 'Motion process finished'.

Table column	Contents of column
	Switching to archive video of specific events
Date & time	Date and time the event was recorded in the system in the format DD.MM.YYYY HH:MM:SS
Event type	Event type (information, alarm, debug, error)
Description	System description of the event

The search results table may be more than one page. To navigate through a table which is more than one page, use the following buttons (2):

1. **Back** Goes back to the previous page of the table.
2. **Next** Goes to the next page of the table.

## Exporting Event Search Results

To export the system log event search results, click the **Export** button.



















This is a close-up of the 'Filter parameters' section. It shows the 'From' (02/14/13 08:00:00 AM), 'To' (02/14/13 11:59:59 PM), and 'Event type' dropdown menus. There is an unchecked checkbox for 'Add new events to results of the search' and an empty search box. At the bottom, the 'Export' button is circled in red, along with 'Back', 'Next', 'Clear', and 'Search' buttons.

When you do this, the standard Windows "Save as" dialog box appears, using which you can save the search results as a file with a .txt (text) extension or .csv (comma-separated).

Date & time	Event type	Description
23/09/2010 16:49:53	Alert	Camera Camera.
Change in the alert status: alert processed by user root with resolution False alert		
23/09/2010 16:35:45	Alert	Camera Camera.
Alert initiated by user root		
23/09/2010 16:35:43	Alert	Camera Camera.
Change in the alert status: alert processed by user root with resolution False alert		
23/09/2010 16:32:50	Alert	Camera Camera.
Alert initiated by user root		
23/09/2010 16:32:49	Alert	Camera Camera.
Change in the alert status: alert processed by user root with resolution False alert		
23/09/2010 16:28:05	Alert	Camera Camera.
Alert initiated by user root		
23/09/2010 16:28:03	Alert	Camera Camera.
Change in the alert status: alert processed by user root with resolution False alert		
23/09/2010 16:26:11	Alert	Camera Camera.
Alert initiated by user root		
23/09/2010 16:23:41	Alert	Camera Camera.
Change in the alert status: alert processed by user root with resolution False alert		
23/09/2010 16:22:33	Alert	Camera Camera.
Alert initiated by user root		

## Switching to archive video of specific events

To switch to archive video of specific events, click the  icon next to the event or double-click the relevant row.

 Date & time	Event type	Description
 09/05/12 03:34:29 PM	Info	Camera 5. Airport. Motion process started
 09/05/12 03:34:28 PM	Info	Camera 5. Airport. Motion process started
 09/05/12 03:34:28 PM	Info	Camera 5. Airport. Motion process started
 09/05/12 03:34:28 PM	Info	Camera 5. Airport. Motion process started
 09/05/12 03:34:27 PM	Info	Camera 5. Airport. Motion process started
 09/05/12 03:34:27 PM	Info	Camera 5. Airport. Motion process started
 09/05/12 03:34:27 PM	Info	Camera 5. Airport. Motion process finished
 09/05/12 03:34:26 PM	Info	Camera 5. Airport. Motion process started
 09/05/12 03:34:26 PM	Info	Camera 5. Airport. Motion process started
 09/05/12 03:34:26 PM	Info	Camera 5. Airport. Motion process started
 09/05/12 03:34:26 PM	Info	Camera 5. Airport. Motion process started
 09/05/12 03:34:25 PM	Info	Camera 5. Airport. Motion process started
 09/05/12 03:34:25 PM	Info	Camera 5. Airport. Motion process finished
 09/05/12 03:34:24 PM	Info	Camera 5. Airport. Motion process started
 09/05/12 03:34:23 PM	Info	Camera 5. Airport. Motion process started
 09/05/12 03:34:23 PM	Info	Camera 5. Airport. Motion process finished
 09/05/12 03:34:23 PM	Info	Camera 5. Airport. Motion process started
 09/05/12 03:34:23 PM	Info	Camera 5. Airport. Motion process finished

The system will now switch to archive mode and fetch the video of the selected event.

## Working with Axxon Next Through the Web Client

### Starting the web client

Use of Axxon Next through a web client takes place remotely, through a web browser and the TCP/IP protocol. Remote video surveillance via a web browser does not require installation of Axxon Next.



#### Important

The current version of the web client is not supported in Internet Explorer

To start the web client:

1. Start a web browser.
2. In the address bar, type the address of the Axxon Next server in the following format: <web server IP address>:<Port>/<Prefix>.



3. Enter a user name and password for connecting to the Axxon Next web server.

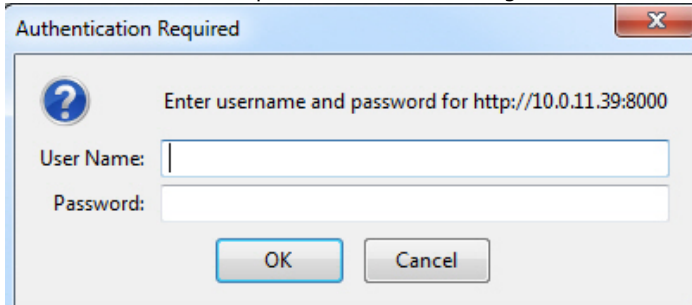

The web client interface is then displayed.



The web client interface has the following interface elements:

1. Video camera selection panel with window for previewing available cameras (1)
2. Slider for changing the size of preview windows (2)
3. Field for searching by camera name (3)
4. Message window (4)

## Searching for video cameras in the web client

A search for video cameras is performed as follows:

1. In the **Search by name** field, type part of a camera's name (1).

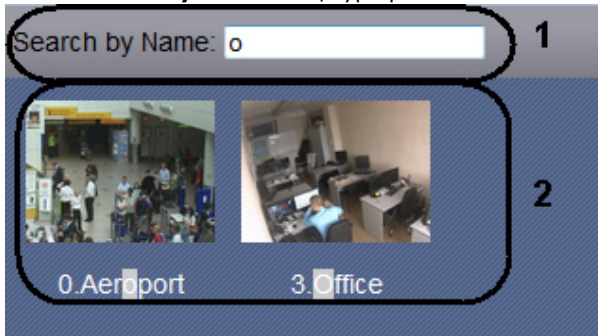

2. The video camera selection panel now shows only the cameras that fit the search term (2).

Video camera search is complete.

## Real-time video surveillance via the web client

To view video from surveillance cameras in real time:

1. In the list of available cameras, select the relevant camera (1).

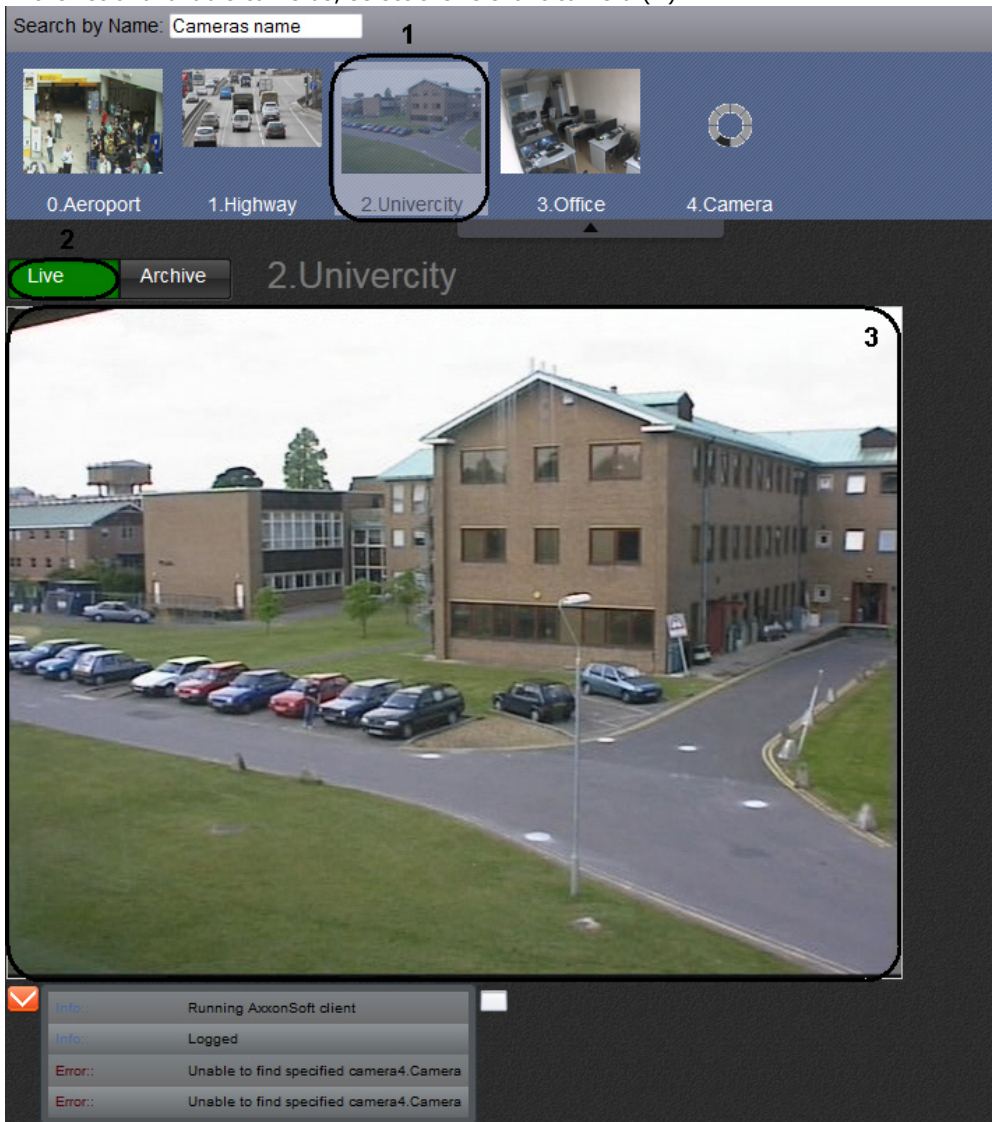

2. Click the **Live** button (2).
3. A web client viewing tile is then displayed (3).

### Note

After a viewing tile is opened, the video camera selection panel is minimized. To expand the video camera

selection panel , click the  button

## Viewing video archives through the web client

To view archived video for a video camera:

1. In the list of available cameras, select the relevant video camera (**1**).

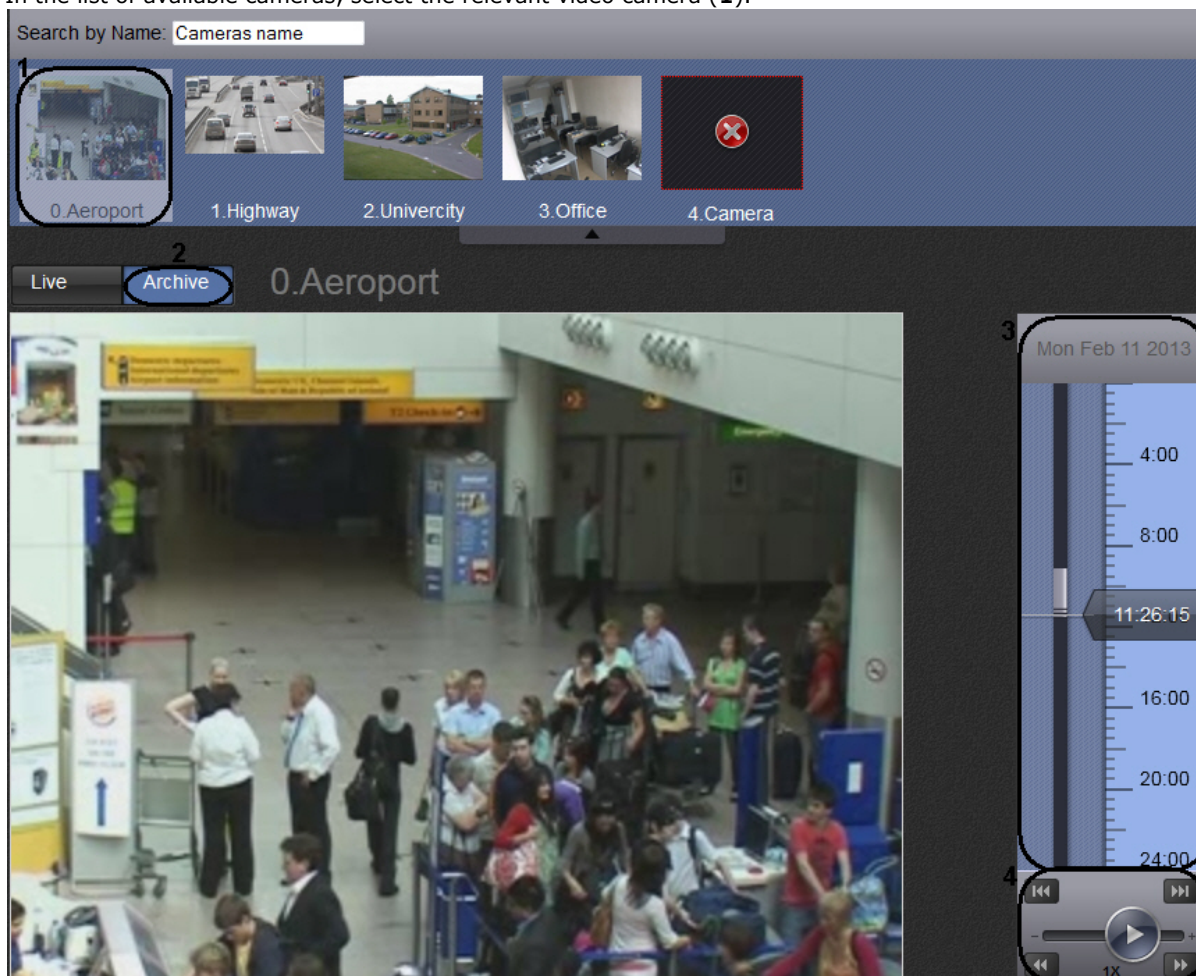

2. Click the **Archive** button (**2**).
3. The archive navigation panel is then displayed, with the following interface features:
  - a. Timeline (**3**). Archive navigation via the timeline in the web client is the same as when working in the Axxon Next client (see [Navigating Using the Timeline](#)).
  - b. Playback control panel (**4**). Archive navigation via the playback panel in the web client is the same as when working in the Axxon Next client (see [Navigating Using the Playback Panel](#)).
  - c. Archive position selection panel. The archive position selection panel is opened by left-clicking the date above the timeline (see [Navigating Using the Archive Position Selection Panel](#)).

## Archive position selection panel for the web client

To choose a time position in the archive by using the archive position selection panel:

1. Click the date above the timeline to open the position selection panel (**1**).

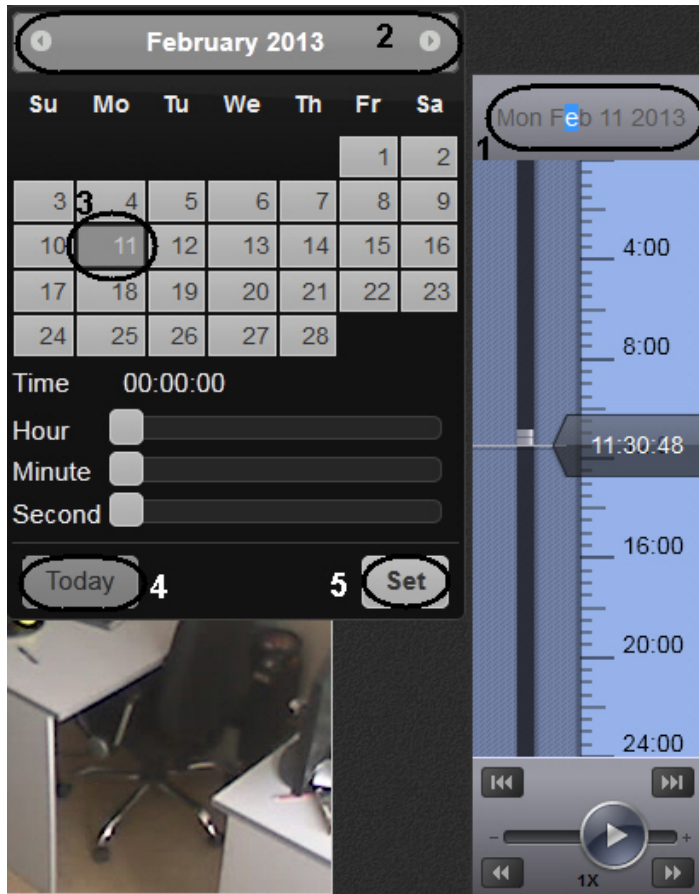

2. To set the playback position to the current time and date, click the **Today** button and go to step 6 (4).
3. Use the ◀ and ▶ buttons to select a month (2).
4. Click the necessary date on the calendar to select a day (3).
5. Use the **Hours**, **Minutes**, and **Seconds** sliders to set the time.



6. To set the playback position, click the **Set** button (5).

The time position in the archive is now chosen.

## Digital video zoom in the web client

Digital zoom of video occurs in a viewing tile during viewing of live video as well as when viewing archive video. To increase the zoom level, use the mouse scroll wheel.

The image cannot be made smaller than the source size. The maximum video zoom is 16x.

To select the viewed portion of the frame at a changed scale, drag the mouse outside of the video viewing area.



### Note

For PTZ units, you can zoom in by using the buttons in the **zoom** group

## Controlling PTZ cameras through the web client

A PTZ video camera is controlled through the PTZ device control panel.

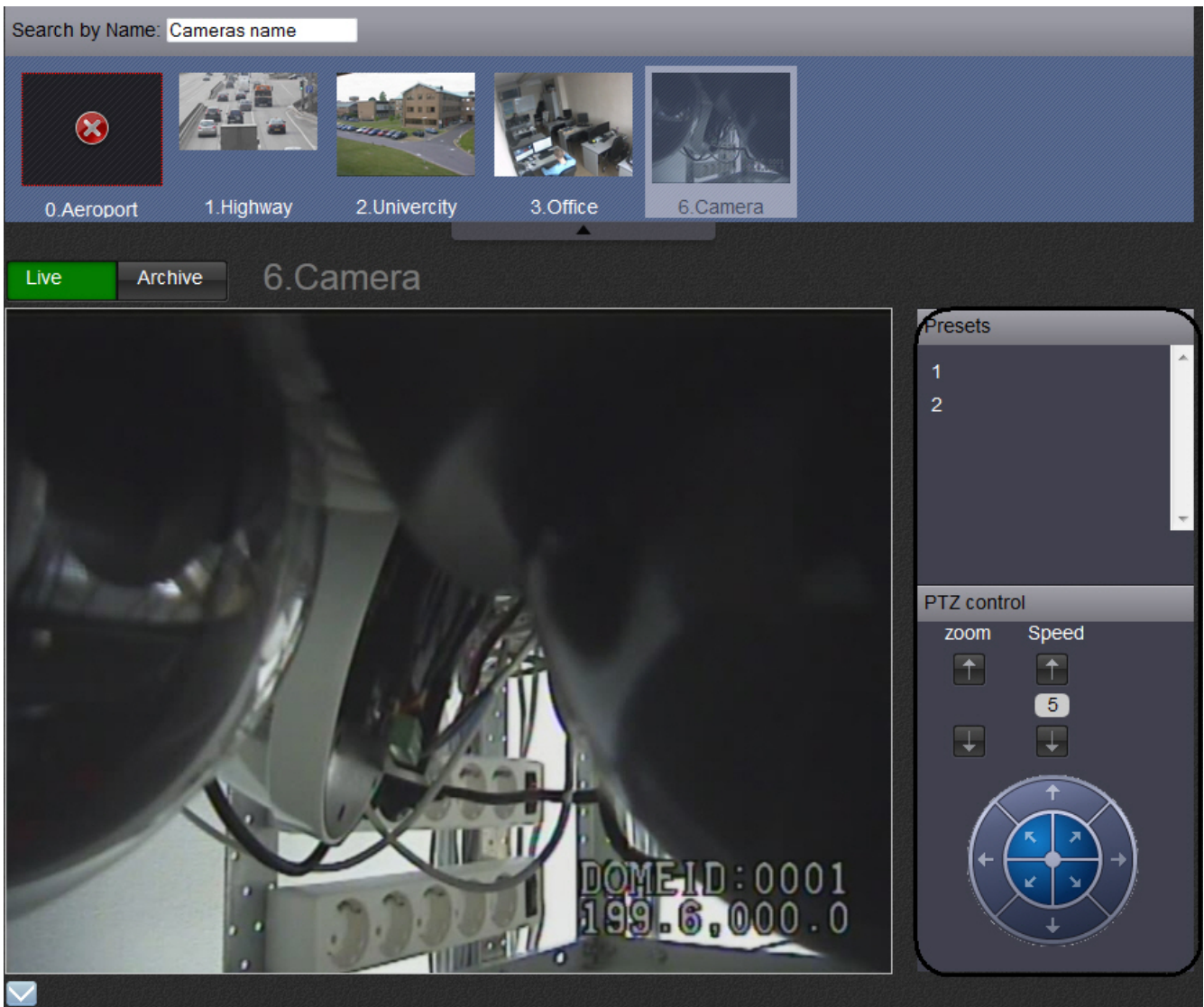

The following actions can be performed using the PTZ device control panel:

1. Use presets.
2. Adjust optical zoom and positioning speed of the video camera.
3. Modify the horizontal and vertical tilt angle of the video camera.

## Controlling a PTZ camera through the web client by using presets

To go to a preset, select the relevant line in the list of presets.





## Changing the optical zoom of a PTZ camera in the web client

To change the optical zoom of a PTZ unit, use the buttons in the **zoom** group.



 – increase image

 – reduce image

 – field for displaying speed at which the camera changes the zoom scale

## Changing the positioning speed of a PTZ camera in the web client

To change the positioning speed of a PTZ camera, use the buttons in the **Speed** group.



 – increase positioning speed

 – reduce positioning speed

 – field displaying the current positioning speed

## Changing the tilt of a PTZ camera in the web client

To change the tilt of a PTZ camera, use the arrows in the **PTZ Control** group.





The arrow direction indicates the direction in which the camera lens will be moved when the arrow is clicked.

## Web client message window

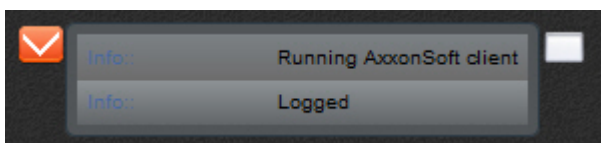
The web client message window, on the lower part of the screen, displays messages about errors and actions performed by the client.



To close the message window, click the  button.

To clear the message window, click the  button.

## Working with Axxon Next Through the Mobile Clients

## On page:

- [iOS Client](#)
- [Android Client](#)

Axxon Next clients are available on the iOS and Android operating systems.

For more information on configuring and using the mobile client apps, refer to the [corresponding documentation](#).

## iOS Client

The client app for mobile devices running iOS (version 5.0 and later) is available for free on the Apple [App Store](#) and works on the following devices:

- iPhone 3GS, iPhone 4, iPhone 4S, iPhone 5
- iPod touch (third generation and later)
- iPad (all generations)

The client for iOS devices allows connecting to Axxon Next servers (version 3.0 and later).

With this app, you can:

- Watch live video
- Control PTZ cameras
- View previously recorded video
- Zoom in (with digital zoom)

## Android Client

A client for the Axxon Next VMS is available for mobile devices running Android (version 2.3.3 and later) and is available for free on [Google Play](#).

The client for Android devices allows connecting to Axxon Next servers (version 3.0 and later).

With the client, you can:

- Watch live video
- Control PTZ cameras
- View previously recorded video
- Zoom in (with digital zoom)

# Description of utilities

## Activation Utility

License activation for the Axxon Next software package is carried out through the product activation utility.

You can launch the product activation utility from the Windows **Start** menu: **Start -> All Programs -> Axxon Next -> Utilities -> Program Activation**.



### Note

The product activation utility program file LicenseTool.exe is located in the folder <Directory where Axxon Next is installed>\Axxon Next\bin\

Then you must select the name of one of the Axxon Domain servers to which the license file will be applied (the file is applied to all Axxon Domain servers launched at the moment of activation) and connect to the system, under an administrator's user name and password, to continue the activation process.



When the utility has loaded, its main will be displayed.

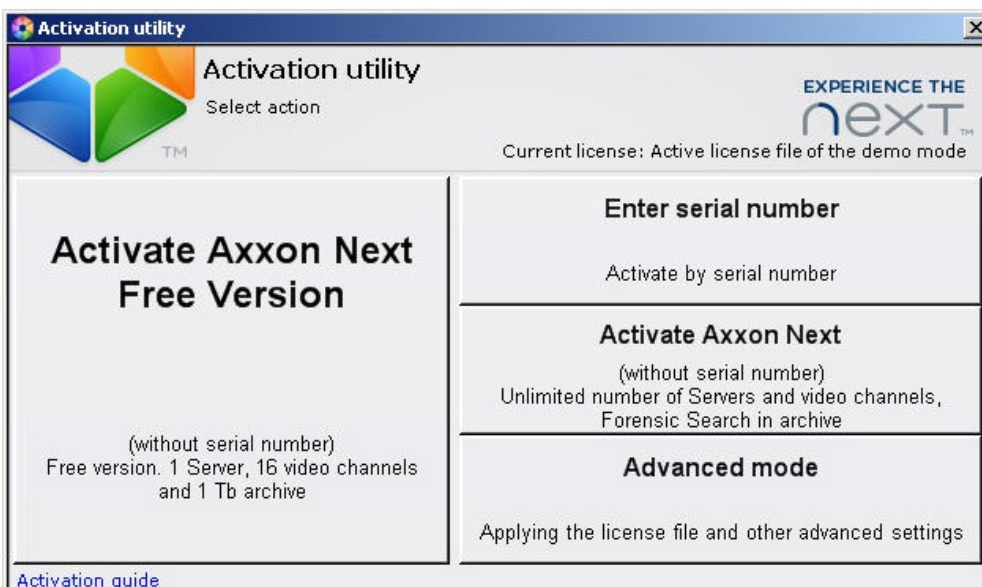
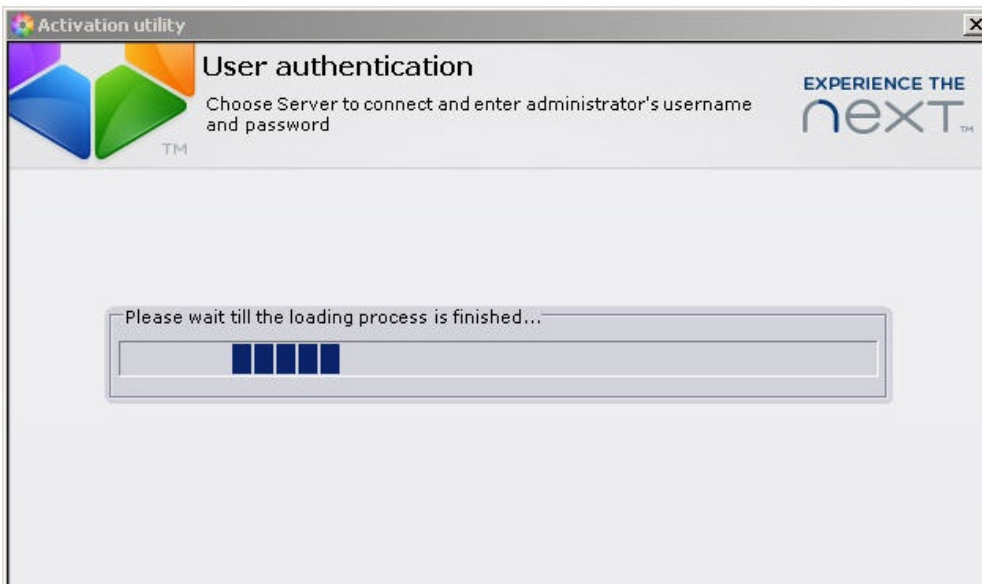

To activate Axxon Next, please refer to the document titled [Activation Guide](#), which presents step-by-step instructions on activating, updating and upgrading Axxon Next .

It is also recommended that you use the prompts displayed in the product activation utility's dialog boxes.

# Axxon Support Tool

## Purpose of the Support.exe Utility

The Support.exe utility is designed to collect information about the configuration and operating status of hardware, the Windows operating system, and the Axxon Next software. The utility generates an archive that can be used by the company's technical support department. In case of malfunctions or errors in the Axxon Next software package, please visit our technical support server at <https://support.axxonsoft.com/> and compose a message containing a description of the problem and attach the archive that was generated by the Support.exe utility.

[Play corresponding video](#)

## Launching and Closing the Utility

The Support.exe utility is launched using the **Start** menu, which is intended for launching user programs in Windows. Go to **Start All Programs Axxon Next Utilities Support Tool**.



### Note

The Support.exe utility is located in the folder <Axxon Next installation directory>\AxxonNext\Support

The Support.exe utility dialog box will then be displayed.

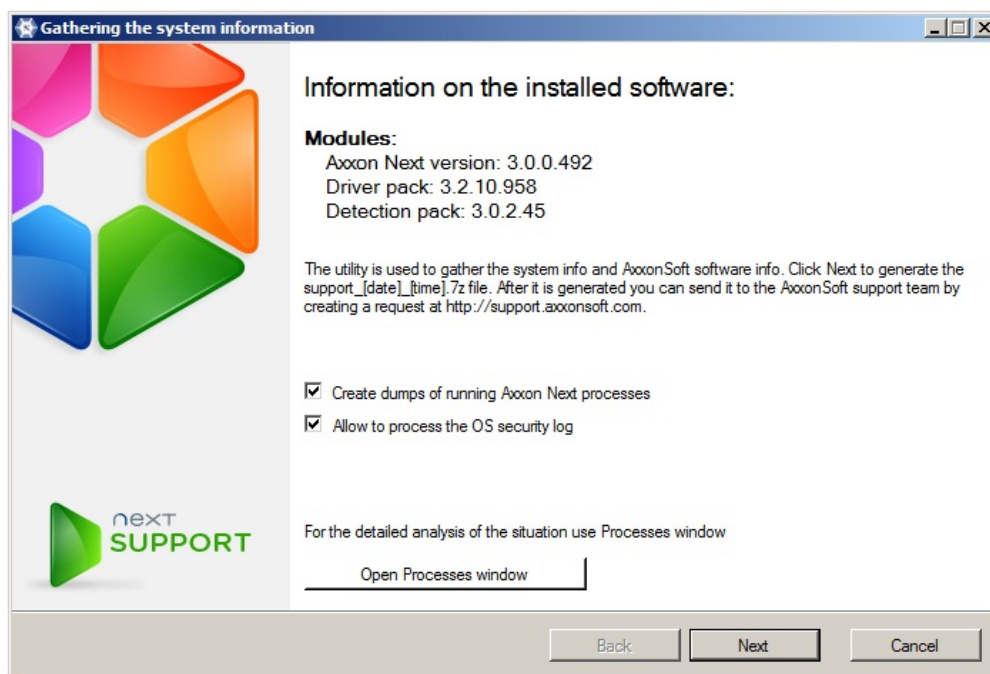

To close the Support.exe utility, click the **Cancel** button or .

## Description of the Support.exe utility interface

The Support.exe user interface includes the following elements:

1. Summary of installed software **(1)**.
2. Short instructions on how to use the Support.exe utility **(2)**.
3. Check boxes for configuring data collection **(3)**.
4. A button for launching the **Processes** service, which offers an in-depth situation analysis **(4)**.
5. A button for starting the information gathering process **(5)**.

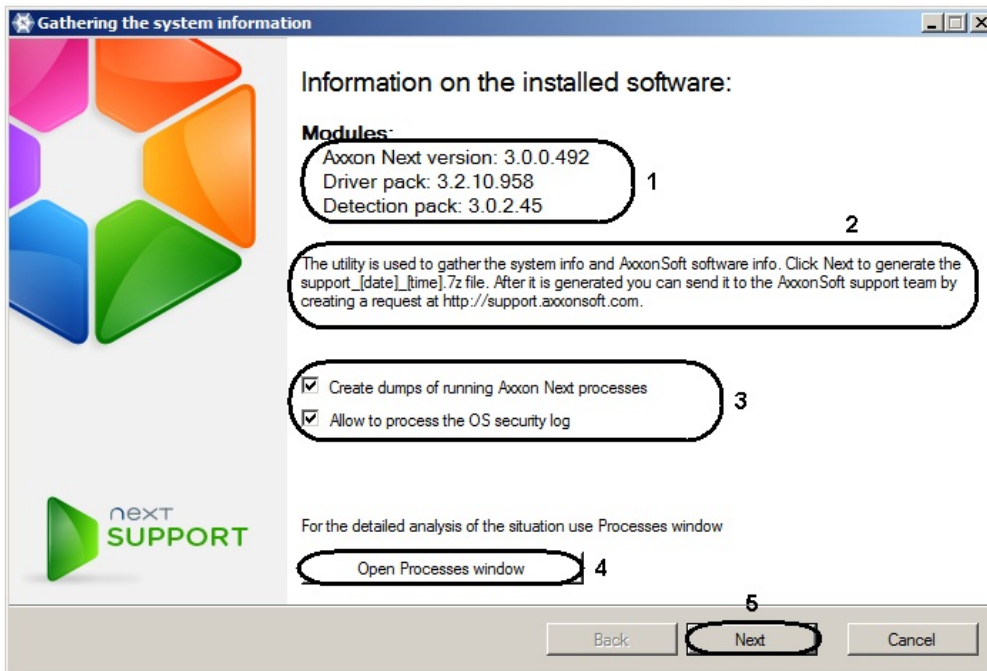

## The Processes Service

The **Processes** service is used for detailed analysis of a situation. To launch it, click the **Start the Processes service** button on; the **Processes** window will then appear, displaying information about processes running on the computer initiated by the Support.exe utility.

PID	Process name	CPU us...	Memory	Workin...	Read	Process...	V.mem.	Written
1248	AXXON.MiscMMSS		18 MB		424 KB	NT AU...	93 MB	0 MB
2232	AXXON.Detector_0	32.8%	146 MB		2854 KB	NT AU...	581 MB	0 MB
2388	AXXON.VMDA		209 MB		183 KB	NT AU...	422 MB	73 MB
2532	AXXON.NVR_PRO...		5 MB		168 KB	NT AU...	90 MB	0 MB
2720	AXXON.NVR_ARC...	0.51%	60 MB	-3072 KB	1066874...	NT AU...	255 MB	183962...
3016	AXXON.Bootstrap		11 MB		96462 KB	NT AU...	89 MB	1996 MB
3256	AXXON.Discovery		53 MB		5484 KB	NT AU...	319 MB	0 MB
3608	AXXON.FileBrowser		5 MB		169 KB	V-BELY...	62 MB	5 MB
3780	AXXON.InfraServer		1 MB		168 KB	NT AU...	58 MB	0 MB
3932	AXXON.Iprint		41 MB		1264635...	NT AU...	193 MB	0 MB
3940	AXXON.MMSS		4 MB		168 KB	NT AU...	86 MB	0 MB
3952	AXXON.NVR	0.51%	65 MB		76265 KB	NT AU...	319 MB	2658 MB
3964	AXXON.Notification	3.07%	77 MB		4054 KB	NT AU...	363 MB	5904 MB
4140	AXXON.Decoder_0	9.35%	110 MB		168 KB	NT AU...	245 MB	0 MB
7176	AXXON.Detector_1		18 MB		170 KB	NT AU...	91 MB	0 MB

A list of all possible Axon Next processes is given in the table.

Process	Description
AXXON.Discovery	Process that searches for peripheral devices (video cameras, analog video cards, devices connected to a serial port, etc.)
AXXON.VMDA	Process responsible for the metadata database. Writes metadata and searches the archive.
AXXON.MMSS	Web server process

AXXON.Notification	Process for managing events in the system and creating a database of these events
AXXON.AxxonNext	GUI process
AXXON.Bootstrap	Main process responsible for configuration, licensing, storing settings, and starting other processes
AXXON.FileBrowser	Process that provides access to the file system and information about server files
AXXON.NVR	Logic module responsible for alarms and automatic rules
AXXON.InfraServer	Process responsible for interaction between Axxon Next modules
AXXON.Decoder	Process that performs decoding of multimedia streams
AXXON.Detector	Process that performs detection
AXXON.Proxy	Process that performs buffering and grooming of multimedia streams
AXXON.NVR_Archive	Process that writes multimedia data to the archive
AXXON.Ipint	Process that interfaces with the Drivers Pack
AXXON.MiscMMSS	Process that plays back audio on the server audio card



**Note**

Selecting the **Display information about all system processes** check box enables viewing of all processes running on the computer.

PID	Process name	CPU us...	Memory	Workin...	Read	Process...	V.mem.	Written
1036	svchost.exe	7.93%	16 MB		55884 KB	NT AU...	107 MB	6328 MB
1092	SearchFilterHost.exe		3 MB		15 KB	NT AU...	23 MB	0 MB
1100	jusched.exe		2 MB		6 KB	ITVGR...	86 MB	0 MB
1148	firefox.exe		225 MB		4059079 ...	ITVGR...	609 MB	852113 ...
1196	svchost.exe		14 MB		8 KB	NT AU...	94 MB	5 MB
1248	AXXON.MiscMMSS		18 MB		424 KB	NT AU...	93 MB	0 MB
1280	LogRotate.exe		6 MB		715 KB	NT AU...	132 MB	113 MB
1324	svchost.exe		7 MB		1930 KB	NT AU...	70 MB	661 MB
1344	ndsvc.exe		0 MB		0 KB	NT AU...	45 MB	1 MB
1400	Snagit32.exe		24 MB		201 KB	ITVGR...	253 MB	0 MB
1464	svchost.exe		8 MB		1 KB	NT AU...	81 MB	0 MB
1484	NvXDSync.exe		7 MB		0 KB	NT AU...	85 MB	0 MB
1496	nvsvs.exe		4 MB		0 KB	NT AU...	84 MB	0 MB
1580	spoolsv.exe		5 MB		1 KB	NT AU...	76 MB	0 MB
1608	svchost.exe		8 MB		96148 KB	NT AU...	54 MB	373 MB
1624	AAM Updates Notif...		1 MB		332 KB	ITVGR...	98 MB	206 MB
1748	sqlservr.exe		6 MB		6318 KB	NT AU...	1564 MB	3452 MB
1756	dwengine.exe		68 MB		2470494 ...	NT AU...	341 MB	165274...
1788	svchost.exe		1 MB		493 KB	NT AU...	33 MB	0 MB
1808	BCUService.exe		1 MB		0 KB	NT AU...	36 MB	0 MB
1944	openvpnserver.exe		0 MB		4 KB	NT AU...	11 MB	0 MB
1992	svchost.exe		1 MB		287 KB	NT AU...	32 MB	0 MB
208	taskmgr.exe		9 MB		47 KB	ITVGR...	66 MB	0 MB
2212	conhost.exe		0 MB		17 KB	NT AU...	20 MB	0 MB
2224	conhost.exe		0 MB		17 KB	NT AU...	20 MB	0 MB

Click the button to close the **Processes** window.

## Collecting Data on the Configuration of Servers and Clients Using the Support

To collect data using the Support.exe utility, perform the following:

1. Launch the Support.exe utility (see the section [Launching and Closing the Utility](#)).
2. Select check boxes as necessary to collect information about the system (**1**).



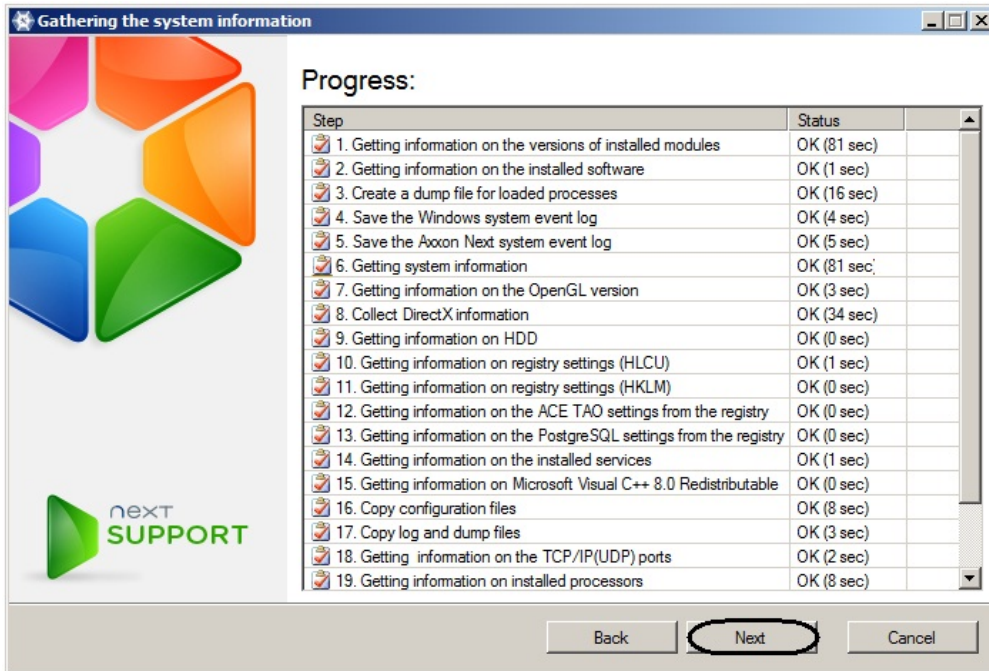

5. A window containing information about the generated archive **support\_[date]\_[time].7z** will then appear. You can access the folder containing this archive by clicking the **Open directory with file** button.



**Note**

The archive is located in the folder <System disk>:\Documents and Settings\<<Current User>\My Documents if you're using Windows XP, or in the folder <System disk>:\Users\<<Current User>\Documents if you're using Windows Vista

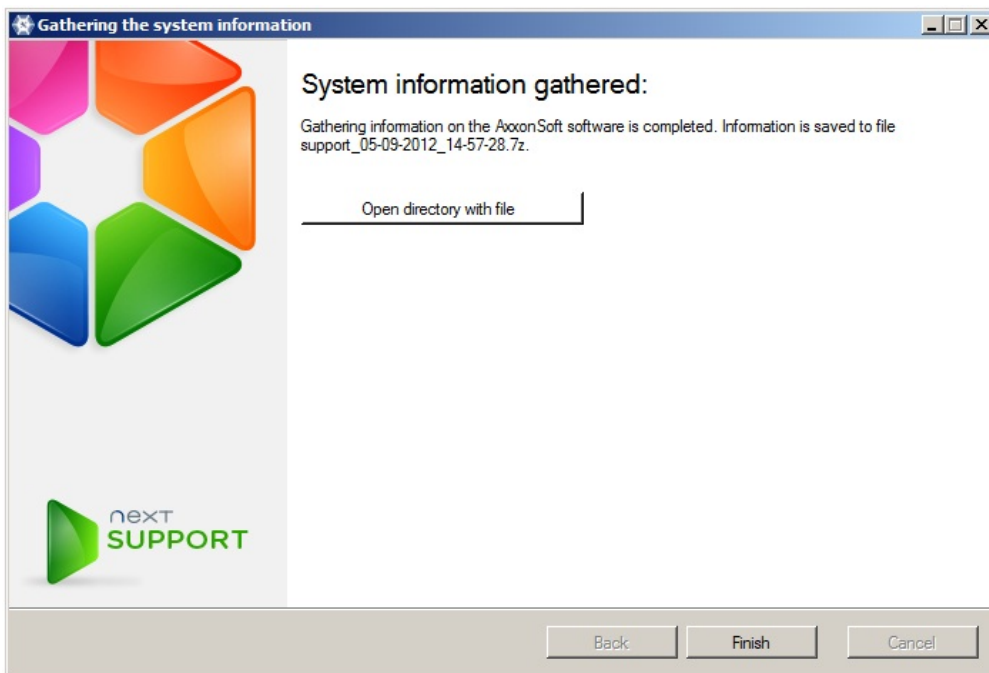

6. Send an email with the attached **support\_[date]\_[time].7z archive** to the ITV technical support department.

## Log Management Utility

By default, information about all system events is recorded in the Axxon Next system log, which is stored in a local database of the server. It is possible to record information about desired events in external logs, which are log files stored in local directories of a server. Log data is archived at set intervals and moved to the log archive. Configuration of these capabilities is carried out through the log management utility.

Axxon Next component	Log storage directory
Server	<Axxon Next installation folder Axxon Next>\logs

Client	<pre>&lt;Letter of system disk&gt;:\Users\&lt;User&gt;\Appdata\Local\AxxonSoft\Axxon Next\logs (for Windows 7 and Windows Vista) &lt;Letter of system disk&gt;:\ &lt;Letter of system disk&gt;:\Documents and Settings\User\Local Settings\Application Data\AxxonSoft\AxxonNext\Logs (for Windows XP)</pre>
--------	---

The log management utility is used to configure the following parameters:

1. Parameters for the archive of external logs containing information about system events.
2. Logging levels for the Axxon Next client and server.

## Play corresponding video

## Starting and closing the utility

The log management utility can be launched using the **Start** menu, which is intended for launching user programs in Windows. **Start All Programs Axxon Next Utilities Logs Archiving**



### Note

The log management utility is located in the folder <System disk>:\Program Files\Common Files\AxxonSoft\LogRotate

The log management utility dialog box will then appear.

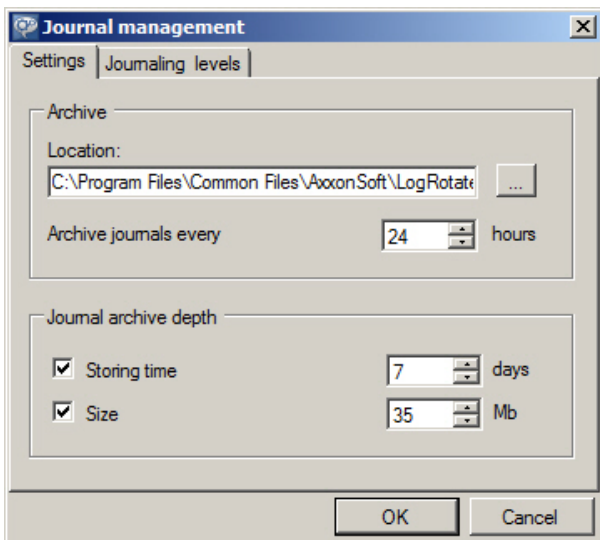

To close the log management utility, click the **Cancel** button or  (accessible in both tabs of the utility).

## Configuring a Log Archive

Configuring a log archive is carried out in the Settings tab of the log management utility.

To configure a log archive, you must perform the following steps:

1. In the **Archive location** field (1), enter the complete path to the directory to which the event logs should be moved after archiving.



### Note

To set the path using standard Windows methods, click 

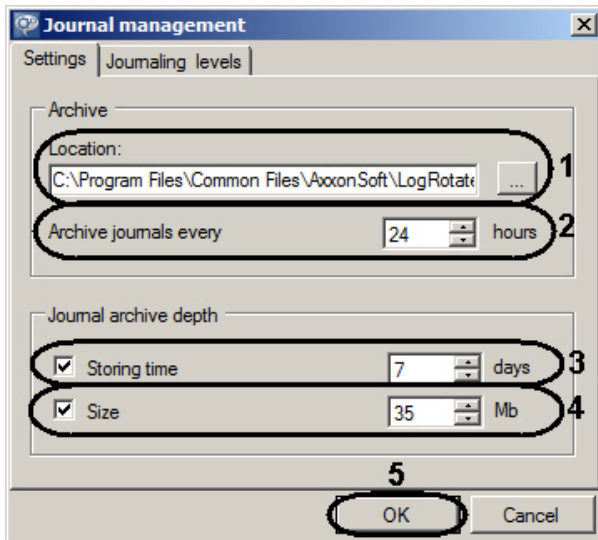

2. In the **Archive logs every...hours** field (2), enter the interval for event log archiving, in hours.
3. In the **Log restrictions** group, set the following parameters:
  - a. In the **Retention period** field (3), indicate the maximum retention time in days of a log in the archive, after which the log is deleted.
  - b. In the **Size** field (4), indicate the maximum size of the archive, above which the oldest logs are deleted from the archive.



**Note**

Archive disk space restrictions take priority over log retention time restrictions. For example, the oldest logs will be automatically deleted even if their retention time has not expired, if the archive size has exceeded the maximum value



**Note**

If it is not necessary to impose any limitations on log retention period and/or size, clear the corresponding check boxes in the **Log restrictions** (3-4)

4. Click **OK** (5) to save changes.

Configuration of the log archive is now complete.

## Configuring Logging Levels

logging levels differ in the list of events to be recorded in external logs, as well as the level of event specification (low, medium, high). Configuration of levels is carried out in the **logging levels** tab of the log management utility.

To configure the logging level, you must perform the following steps:

1. Select the desired logging level of the client (Axxon Next Client) and the server (Axxon Next Server) (1).

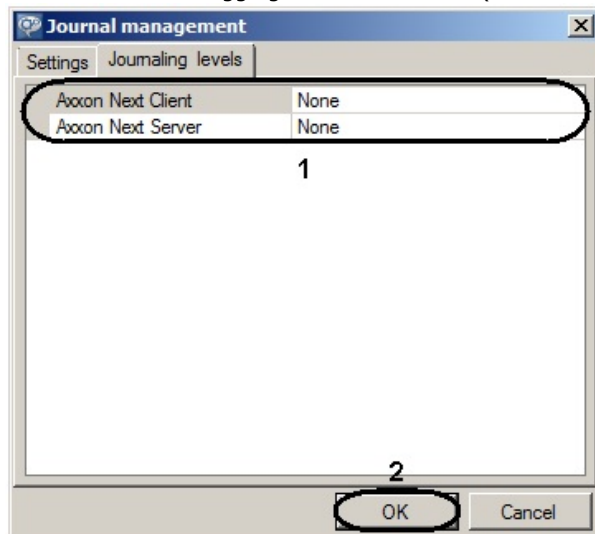

**Note**

If you change the logging level of a Server, the server will be restarted

logging level	logging level description
None	Event logging disabled
Error	Low specification level – only system errors are logged
Warning	Low level of detail - only system warnings and system errors are logged
Info	Low level of detail - logs informational messages, system warnings, and system errors
Debug	Medium level of detail - logs debugging events, informational messages, system warnings, and system errors
Trace	High specification level – all system events are logged

2. Click **OK (2)** to save changes.

Configuration of logging levels is complete.

## Digital Signature Verification Utility

This utility verifies the digital signature that is added during export of video and snapshots from Axxon Next.

To start the utility, open the standard **Start** menu in Windows: **Start > Programs > Axxon Next > Utilities > Watermark checker**.

**Note**

The utility executable file WatermarkCheck.exe is also located in the folder <Directory where Axxon Next is installed>\Axxon Next\bin\.

To check a digital signature, click the **Open file** button and select the file of the exported snapshot or video.

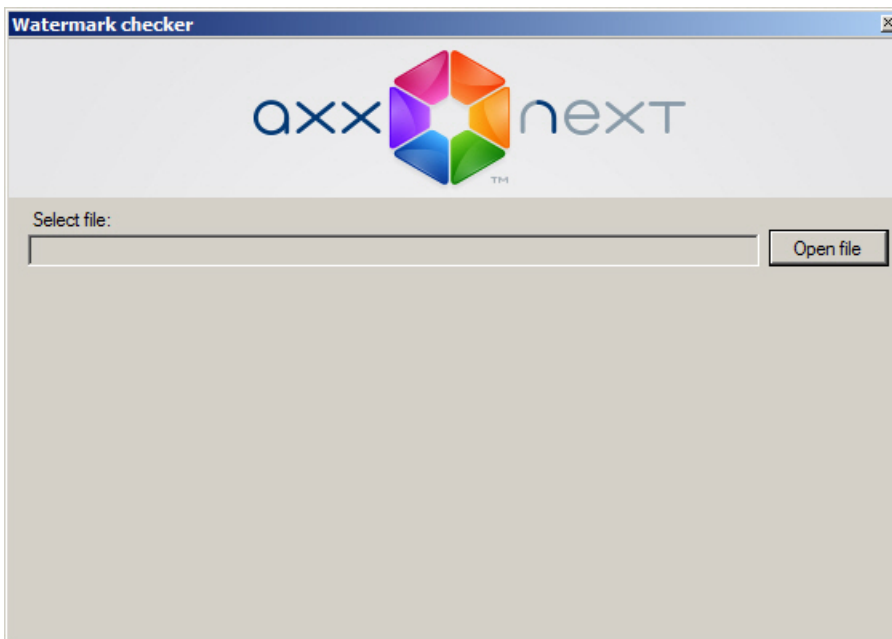

If the digital signature is valid, the utility will show the message: **Signature check: OK!**

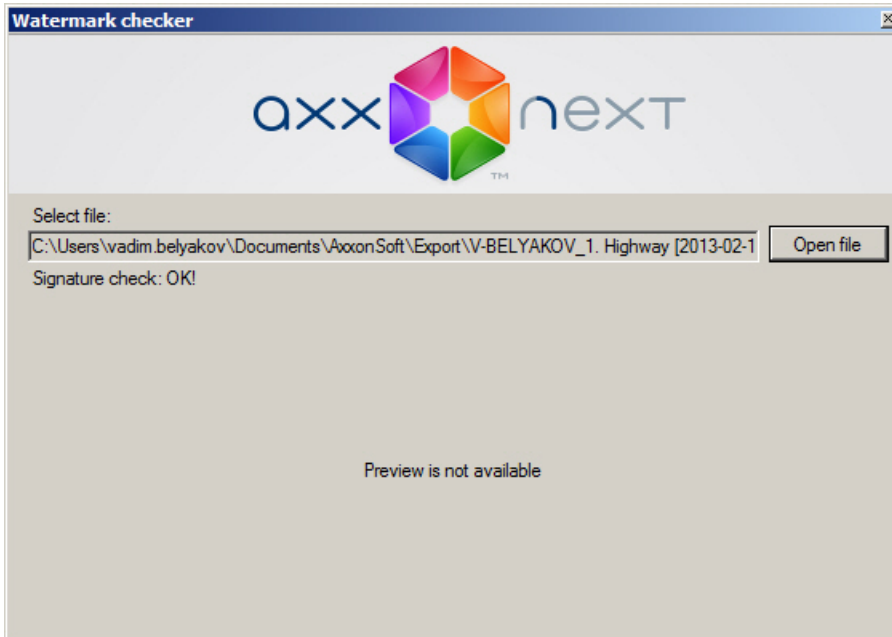

If it is not valid, the utility will show the message: **Signature check: Invalid signature!**



**Note**  
During verification of a digital signature, the thumbnail of a snapshot is shown in the utility window. Videos cannot be previewed during the verification process

Digital signature verification is now complete.  
To quit the utility, click the  button.

[Play corresponding video](#)

## Appendices

### Appendix 1. Glossary

Active viewing tile - viewing tile currently in use by the user.

AWS (automated workstation) – security system user workstation, a minimally equipped personal computer with Axxon Next software installed.

Archive – all audio/video files stored on a hard disk that can be played and exported to supported formats.

Default archive of a video camera – the archive to which images from a given video camera are recorded during user-initiated alarms.

Audio detection tool – a detection tool is triggered used to analyze the audio signal from a microphone.

Audio recording – 1. the process of recording a digitized audio signal on a hard disk.  
2. audio data stored in a specific format on a hard disk.

The audio subsystem encompasses all the tools that provide for the collection of audio data, its processing, and its storage on media.

Video detection tool – a detection tool is triggered used to analyze the video image from a video camera.

Video recording – 1. the process of recording a digitized video signal on a hard disk.  
2. video information stored in a specific format on a hard disk.

Video camera – 1. source of a video signal.  
2. a system object displaying the properties of an installed video camera and controlling its operation.

The video subsystem encompasses all the tools that provide for the acquisition of video data, its processing, and its storage on media.

Timeline – an interface object used to search for video recordings and navigate an archive.

Sensor – 1. a physical device intended for receiving information on the status of an object.  
2. a system object that displays the properties of an installed sensor.

Situation analysis detection – a detection tool is triggered used to analyze the situation in a camera's field of view according to set criteria.

Audio signal detection– a detection tool is triggered which is triggered by an increase in the signal/noise ratio above a set level.

Loss of quality detection– a detection tool is triggered which is triggered by a loss of quality in the video image from a camera.

Position change detection– a detection tool is triggered by a substantial change in the background of a video image indicating a change in the position of the camera in space.

Object disappearance detection– a detection tool is triggered by the disappearance of an object in a set area of a video camera's field of view.

Abandoned object detection– a detection tool is triggered when an object remains motionless in a detection zone for a prolonged period.

No Signal detection– a detection tool is triggered that is triggered by the absence of an audio signal from an audio device.

Line Crossing detection– a detection tool is triggered which is triggered when the trajectory of an object crosses a virtual line in a video camera's field of view.

Object appearance detection– a detection tool is triggered by the appearance of an object in a set area of a video camera's field of view.

Stopping detection– a detection tool is triggered by the cessation of motion in a set area of a video camera's field of view.

Noise detection– a detection tool which is triggered by an decrease in the signal/noise ratio below a set level.

Axxon Domain – a selected group of computers on which the server configuration of the *Axxon Next* software package is installed. Linking the servers in a group makes it possible to set up interaction between them, thus organizing a distributed system.

Detection zone – the area of a video image processed by a detection tool is triggered.

Interface cable - cable used to connect two or more devices together for data transfer.

Interface object - a system object used for interaction between the user and software (data input/output).

Client - designation for a personal computer on which *Axxon Next* software is installed (or will be installed) as a **Client**. Designation for the graphical shell of the *Axxon Next* software package.

Slideshow – automatic switching of user layouts, or of viewing tiles in a single layout if working with standard layouts.

Licensing - regulating and setting the terms for usage of AxxonSoft software modules.

Detection zone – 1. the area of a video image processed by a detection tool is triggered.  
2. a tool which allows the user to mark out an area of the video image which is not to be processed by a detection tool is triggered.

Microphone – 1. a source of audio signals.  
2. a system object used to manage the parameters of audio signal reception.

Video surveillance monitor – an interface object used to manage the user interfaces of the *Axxon Next* software, e.g., layouts, viewing tiles, various panels and context menus, etc.

Viewing tile - interface object displaying the video stream coming from a certain video camera and enabling control of that video camera.

Dial panel – panel (part of the PTZ control panel) used to dial a preset.

Archive navigation panel – all interface objects used to work with an archive, e.g., timeline, list of alarm events, etc.

Control panel – panel made up of tabs accessible to the user, used to navigate from one group of interface objects to another.

Playback control panel – panel containing buttons to control playback of video recordings: Play, Pause, Go to next video recording, etc.

PTZ control panel – all interface objects used to control a certain PTZ device.

Layout control ribbon – panel containing tools to create, edit, and manage layouts.

PTZ device – a system object displaying the properties of an installed PTZ camera device.



**Note**

Also used to designate a physical device

The PTZ subsystem encompasses all the tools that provide for remote control of a PTZ device and the lens of a video camera.

The analytics subsystem encompasses all the tools that provide for automatic analysis of incoming video and audio data.

The Forensic Search in archive subsystem is a set of tools for searching video recordings in the archive by using video image metadata.

The relay subsystem encompasses all the tools that provide for the triggering of an execution device connected to the embedded relay port of a video camera or IP server when a detection tool is triggered (including one which processes the embedded sensor of a video camera or IP server) is triggered.

The notification subsystem encompasses all the tools that provide for notification of the user about events which have occurred in the system.

Event registration subsystem – all the tools that provide for the collection of data about system events, processing, and its storage on media.

Pre-alarm recording is the period of pre-event recording that will be added to the beginning of an alarm event recording.

Preset – preprogrammed positioning of a PTZ device.

Software package – all software and hardware tools used together to build a security system.

Software module – a program or functionally complete component of a program used to perform a specific functional task (perform a user function).

Layout – preserved positioning of viewing tiles relative to each other.

Distributed system – a group consisting of several interacting Axxon Next servers (up to four) and clients (unlimited number). Axxon Next servers are linked within an Axxon Domain.

Relay – 1 a physical device/electromechanical switch.  
2. a system object that displays the properties of an installed relay.

Server – designation for a personal computer on which the **Server** configuration of Axxon Next software is installed (or will be installed).

Security system – a set of devices used for video surveillance, audio surveillance, and object recognition, all controlled by the Axxon Next software system.

The system log is a log containing system information on events, including system error entries.

Object tracking – a function which allows an operator to visually track the movement of objects in a camera's field of view.

Alarm flag – the flag symbol designating either the moment an alarm event began or a certain moment before the beginning of an alarm event.

Color coding - software-based graphical notification to a security system operator about the current status or operating mode of system objects (equipment, software modules).

## Appendix 2. Known issues in the Axxon Next Software Package

### Possible Errors During Installation

### On page:

- [Error starting NGP Host Service](#)
- [Errors Connecting to the Postgres Database](#)

## Error starting NGP Host Service

If port 49999 is busy during installation of Axxon Next (for example, because of nethost.exe processes that have not been unloaded since removal of the previous version), an error message regarding the launch of NGP Host Service appears.

To continue installation, free up port **49999** and try again.

## Errors Connecting to the Postgres Database

After installation of the Postgres database, the Axxon Next installer may quit prematurely. This situation may be associated with the inability of the installer to connect to the Postgres database, if the firewall is enabled. To prevent this, disable your firewall during installation.



### Note

Disabling the firewall during installation can cause another problem: see [No signal from video cameras and failure to connect to other servers](#).

## Possible Errors During Start-Up

Launching the Axxon Next software program with client logging enabled can take a long time when the *ESET NOD32 Antivirus 4 Real-time file system protection* mode is on.

To solve this problem, add the Axxon Next installation folder and the folder with the client logs (<Letter of system disk>:\Users\<User>\Appdata\Local\AxxonSoft\AxxonNext\logs) to the list of exceptions in ESET NOD32 Antivirus 4.

## Possible Errors During Operation

### On page:

- [All video cameras or archives stop working once the license maximum is reached](#)
- [No signal from video cameras and failure to connect to other servers](#)
- [Incorrect display of Client interface elements](#)
- [Error creating new archives even when license restriction on total size is observed](#)
- [High CPU load during OpenGL software emulation](#)
- [Performance of Axxon Next when working with NetLimiter 2](#)

## All video cameras or archives stop working once the license maximum is reached

If the activation key allows the use of a smaller number of video cameras than the amount used at the moment on the system, all of the video cameras will cease to function with the system. To resume operation, remove the objects corresponding to the excess number of video cameras and restart the server.



### Note

Restart the Server through the Start menu as follows:

1. All Programs -> Axxon Next -> Shut Down Server
2. All Programs -> Axxon Next -> Start Server

Similarly, if an activation key allows using archives with a total size of an amount less than the current one, you are advised to correct the archive size to the required amount and then restart the server.

## No signal from video cameras and failure to connect to other servers

If the Windows Firewall (or firewall of other manufacturers) was disabled during installation of Axxon Next, Axxon Next services and applications will not be automatically added to the list of firewall exceptions.

If the firewall is later turned on, this can interrupt the signal from video cameras and make it impossible to connect to other servers.

To solve this problem, add the following applications to the firewall exceptions: Apphost.exe, NetHost.exe, AxxonNext.exe, and LicenceTool.exe.



### Note

If ESET NOD32 Smart Security 6 anti-virus software is used, disable Personal firewall

## Incorrect display of Client interface elements

Client interface elements may be distorted on systems with the latest versions of GeForce drivers (such as 327.23) installed.

To resolve this problem, install a previous version of the graphics card driver

## Error creating new archives even when license restriction on total size is observed

If the user creates archives at the same time (in other words, without applying changes) while deleting some existing archives, creation of archives may be forbidden even if the total archive size does not exceed the amount of the license restriction.



### Note

This happens because when verifying the license restrictions, the size of created archives is calculated based on the total size the last time when changes were applied

To regain the ability to create new archives in such situations, the user must first delete unnecessary archives and apply changes.

## High CPU load during OpenGL software emulation

If your computer's graphics card does not meet OpenGL requirements (see [Limitations of the Axxon Next Software Package](#)), OpenGL can be emulated in software.

But this may place a high load on the CPU.

## Performance of Axxon Next when working with NetLimiter 2

If *NetLimiter 2* is installed in the system, there may be a significantly increased load on the processor when working with *Axxon Next*.

This problem is resolved by removing *NetLimiter 2*.

## Appendix 3. Assigning of the domain takes place when the Axxon Next server is installed

The Windows OS will create two accounts when the Axxon Next software package is installed using a **Client and Server** type of configuration.

1. An account with administrator rights which is used by the Axxon Next file browser. The name of this account is set during installation of Axxon Next (see [Installation](#)). For Axxon Next to function correctly, this account must have Windows administrator rights. If the account is a domain user account, you must also add the account to the **Users** and **Power Users** groups.



### Note

The file browser helps to navigate through the Server's file system (such as when choosing disks for log volumes)

The account can also be used for configuring access rights to the hard disk.

2. Axxonpostgres – an account under which the log data database service is started.



### Note

A log database (Postgres) is used for storing system events

## Appendix 4. Using Axxon Next with anti-virus software

### On page:

- [NOD32](#)
- [ESET Smart Security](#)
- [AVG](#)
- [DrWeb](#)
- [McAfee SAAS](#)

Depending on the anti-virus software that you use, when you install, start, and use Axxon Next, your anti-virus software may ask for permission for the software components to perform Internet access.

It is recommended that you allow these components to do so for proper functioning of the application.

Recommendations for specific anti-virus programs are given below.

## NOD32

When using NOD32 Antivirus, it is strongly recommended to either disable the Web Access Protection service or to add the IP addresses of IP cameras to the list of exceptions for anti-virus scanning.

See also section [Possible Errors During Start-Up](#).

## ESET Smart Security

If you use ESET Smart Security, select automatic mode with Firewall exceptions and add the remote servers to the exceptions by creating network rules (for help with creating these rules, refer to the official user guide for the anti-virus software).

## AVG

When using AVG on a configuration with many video cameras, it is strongly recommended to add the IP addresses of IP cameras to the list of exceptions. Otherwise, the avgsa.exe process may severely slow down the CPU. This action can be performed only in the paid version of AVG.

When installing Axxon Next, allow the NetHost.exe and ngpsh.exe processes to run.

## DrWeb

If you use DrWeb anti-virus software, perform the following actions before installing Axxon Next:

1. Disable automatic start of the DrWeb firewall.
2. In the proactive protection settings, select the option to use custom settings and enable the following options:
  - a. Allow low-level disk access
  - b. Allow system services
  - c. Allow loading drivers
  - d. Allow user drivers
  - e. Allow Winlogon shell parameters
3. In the SpiDer Gate settings, add the apphost.exe and AxxonNext.exe processes to the list of exceptions for scanning of incoming traffic. If possible, it is recommended to disable scanning of incoming and outgoing traffic.

## McAfee SAAS

For correct functioning of Axxon Next distributed configurations and remote clients, you must disable the Firewall Protection component in McAfee SAAS.



### Note

It is not necessary to disable this component if your configuration contains a single server and a local client.

## Appendix 5. Using CH VM-Desktop USB multifunction controllers with Axxon Next

CH VM-Desktop USB multifunction controllers offer a range of input controls:

- Three-axis joystick for PTZ and digital zoom control (**J1** and **J2**)
- Jog/shuttle dial (**J3** and **J4**)
- 27 keys
  - 10 number keys
  - \* key
  - # key
  - Programmable keys **C1** to **C13** (keys cannot be remapped in Axxon Next)
  - Two additional keys (**B1** and **B2**)

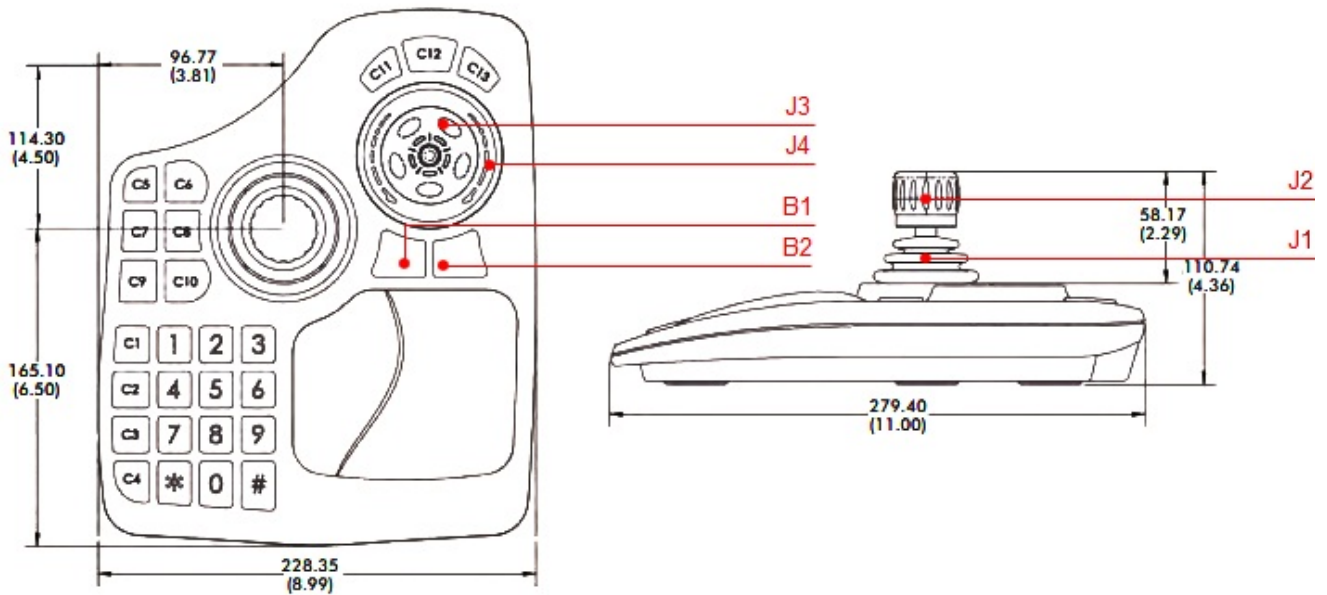

The multifunction controller can be used to operate Axon Next on the active monitor.

**Note**

The active monitor is either the main one (if all additional monitors are inactive or not connected) or an additional one, if the additional monitor is active (see [Configuring Interfaces on a Multi-Monitor Computer](#)).

The active monitor can be selected only by using the mouse. If no mouse is present, the multifunction controller will work on the main monitor only.

A description of key functions is given in the table.

Key	When available	Function
<b>J1</b>	Always	PTZ control for the selected camera. If the selected camera does not support PTZ control, the action is ignored.
<b>J2</b>	Always	Optical zoom control for the selected camera. If the selected camera does not support PTZ control, the action is ignored.
<b>J3</b> (rotate counterclockwise)	Archive mode	Go to previous frame. If playback is active, the action is ignored.
<b>J3</b> (rotate clockwise)	Archive mode	Go to next frame. If playback is active, the action is ignored.
<b>J4</b> (rotate counterclockwise)	Archive mode	Go to previous video fragment.
<b>J4</b> (rotate clockwise)	Archive mode	Go to next video fragment.
<b>J4</b>	Live Video mode	Iris control for the selected camera.
<b>1</b>	Live Video mode	Start/stop patrol mode.
<b>2.3</b>	Live Video mode	Focus control for the selected camera.

<b>* n #</b>	Always	Select a camera in a layout.  n is the number of the camera to be activated via the number keys.  If the camera with the relevant number is not in the current layout, a search is performed for the minimum layout containing the camera; the minimum layout is then displayed.  If no such layout exists, a layout with one camera is created.
<b># n #</b>	Always	Go to layout.  n is the layout to be activated via the number keys; the number corresponds to the order in which the layout appears in the list.
<b>C10</b>	Always	Clear number.  If the operator did not finish typing the number of a camera or layout (the # key was not pressed), pressing the C10 key clears the previously entered number.
<b>C1</b>	Alarm Management mode	Accept alarm with <b>False Alarm</b> resolution.
<b>C2</b>	Alarm Management mode	Accept alarm with <b>Non-Critical Alarm</b> resolution.
<b>C3</b>	Alarm Management mode	Accept alarm with <b>Critical Alarm</b> resolution.
<b>C4</b>	Always	Manually initiate an alarm and go to Alarm Management mode.  Go to Alarm Management mode if an alarm has been previously initiated.
<b>C5</b>	Always	Increase size of layout cell
<b>C6</b>	Always	Reduce size of layout cell
<b>C7</b>	Always	Go to previous layout in the list
<b>C8</b>	Always	Go to next layout in the list
<b>C11</b>	Archive mode	Slow down playback
<b>C12</b>	Archive mode	Start/pause video playback
<b>C13</b>	Archive mode	Speed up playback
<b>B2</b>	Archive mode, Alarm Management mode	Go to Live Video mode (without alarm classification)
<b>B2</b>	Live Video mode	Go to Archive Mode
<b>C9</b>	Archive mode	Open/hide calendar
<b>B1, B2</b>	Open calendar	Cycle through calendar elements (equivalent to pressing the tab key)  <b>days of month - hours - minutes - seconds - am/pm (B2 key)</b> and in reverse (by pressing the <b>B1</b> key)
<b>J3</b>	Open calendar	Navigate by days and set hours, minutes, seconds, and AM/PM
<b>J4</b>	Open calendar	Navigate by months