



Monitoring

Operator's Guide

1. Operator's Guide. Introduction	4
2. Control Panel	4
2.1 Purpose of the Control Panel	4
2.2 Changing alarm group icons	6
2.3 Current display time	6
2.4 Ignoring objects	6
2.5 Processing alarms	7
2.5.1 Confirming alarms	7
2.5.2 Confirming multiple same-type alarms	8
2.5.3 Additional information on alarms	9
2.5.4 Alarm types	10
2.5.5 Defining user alarm types	12
2.5.6 Configuring the Displayed Number of Alarms	12
2.6 Viewing video data on alarms	13
2.6.1 Indication of video data presence	13
2.6.2 Viewing video data	13
2.6.3 Video data grouping setup	14
2.6.4 Setting video data list filter	16
2.7 Event log	18
2.7.1 Viewing comments	18
2.7.2 User that confirmed an alarm	19
2.7.3 Event display period	19
2.7.4 Exporting the event log	19
2.7.5 Configuring the position of the event log's columns	20
2.8 Regulatory and reference information	20
2.8.1 Viewing regulatory and reference information	20
2.8.2 Editing regulatory and reference information	21
2.8.3 Filling out reference books	22
2.8.4 Column context menu in the Monitored objects window	23
2.9 Viewing objects' live video and archives	24
2.9.1 Playing back live video and archive from a specific camera	25
2.9.2 Playing back live video and archive from all cameras	26
2.9.3 Playing back live video and archive from selected cameras	27
2.9.3.1 Creating, editing and deleting layouts	27
2.9.3.2 Selecting layout for display	30
2.10 Starting external applications from the Control Panel	31
2.11 Executing ad hoc command on the Agent of Control by the operator of Server of Control	34
3. Log Panel	35
3.1 Log Panel's interface	35
3.1.1 Color definitions for events	35
3.1.2 Moving through the list of alarms	36
3.1.3 Ignoring objects	37
3.1.4 Status bar	37
3.2 Number of alarms displayed	38
3.3 Object status	38
3.4 Alarm duration	38
3.5 Information about an object	38
3.6 Exceeding the allowed number of failures	40
3.7 Forcing the confirmation of alarms	40
3.8 Custom filter in the Log Panel	41
4. Owner Panel	43
4.1 Owner Panel interface	43
4.2 Objects displayed on the Owner Panel	44

4.3 Viewing Event log for all objects	44
4.4 Viewing details on alarms for all system objects	45
5. Alarm message window	45
6. Search in archive	46
6.1 Purpose of the Search in archive component	46
6.2 Request to a video archive by subtitles	46
6.3 Request to a video archive by video clips	48
6.4 Request for video frames from an object	49
6.5 Request for video clips from objects	51
6.6 Automated video clip loading	54
6.6.1 Video clip request file	54
6.6.2 Operating principle of automated video clip loading	55
7. Monitoring Reports	56
7.1 Purpose of Monitoring Reports	56
7.2 Hardware failures reports	57
7.3 Alarms reports	59
7.4 Video report	61
7.5 Statistical reports	64
7.6 Statistical reports by owners	68
7.7 Vehicle LPs report	69
8. Special operation mode joint with Auto Intellect	70
8.1 Interface of the License plates search window	71
8.2 Interface of the License plates search panel	72
8.3 Viewing recognized LPs	72
9. Controlling unregistered objects	75
10. Appendix 1. Data update periods summary	76
10.1 Data loading from database to the interface objects	76
10.2 Data loading to the database	76
10.3 Sending data from Agent of Control to Server of Control	77
10.4 Data transmission scheme	77
10.5 Features of displaying information on short-term and long-term alarms	77
10.6 Agent of Control technical condition data collection periods	78

Operator's Guide. Introduction

Rus

On page:

- Purpose of Monitoring
- Document purpose

Purpose of Monitoring

Monitoring is designed to automate the activities of personnel at service companies involved in the operation of *Intellect*-powered video surveillance systems. The purpose of *Monitoring* is to improve the quality of operation for such video surveillance systems.

Document purpose

The document is intended for Operators working with *Monitoring*.

This User's Guide describes how to work with *Monitoring*'s main graphic user interface (GUI) objects.

Control Panel

Rus

The Control Panel is part of the **Monitoring** interface window. You can configure this window using the setting panel for the **Monitoring** object. For how to do it, see the document [Monitoring Software Package. Administrator's Guide](#).

You can see the Control Panel in the figure below.

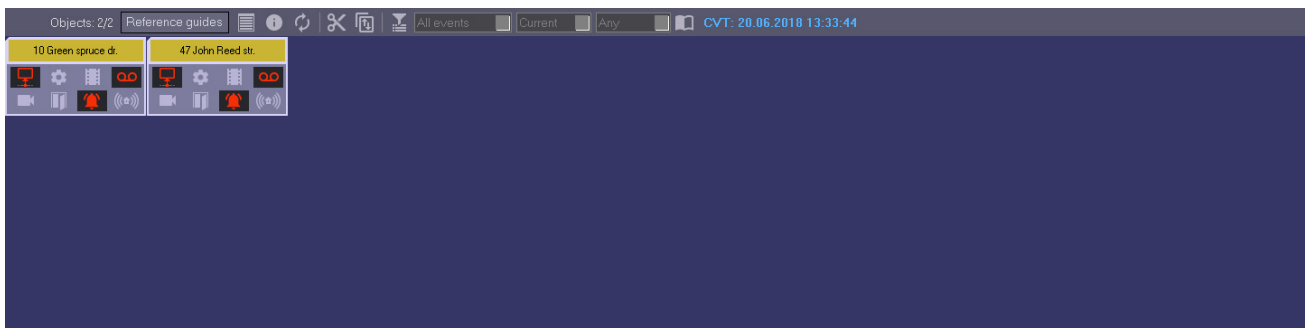

Purpose of the Control Panel

Rus

The Control Panel is intended for quickly assessing the current status of video surveillance components.

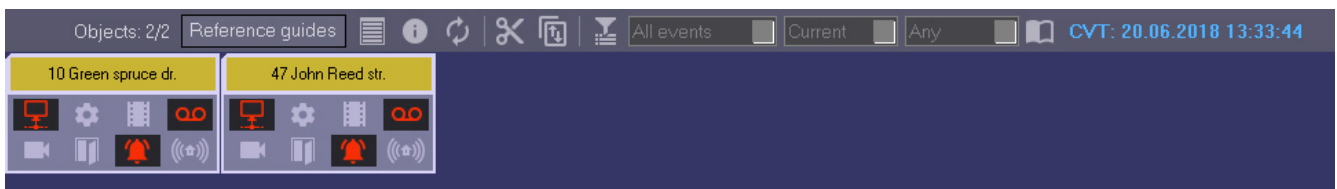

Each object has a corresponding graphic element shown as a rectangle. It contains the object's identification area (at the top) and a configurable number of alarm indication buttons arranged in groups by source type:

1. Communication Channel.
2. Hardware.
3. Video System Software.
4. Size of Archives.
5. Cameras.

6. ACS.
7. FSA.
8. Detection tools/Detectors.
9. Thermal Sensors.

If the **Owner panel** is enabled (see [Configuring the Monitoring interface object](#) section of *Administrator's Guide*), then only the objects that belong to the selected owner are displayed on the Control Panel.

The number of shown alarm groups can change from 4 to 9, depending on the **Monitoring** object settings on the **Interfaces** tab.

Four alarm groups.

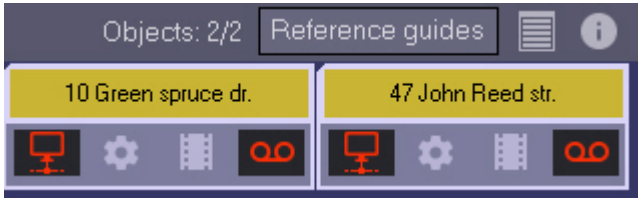

Nine alarm groups.

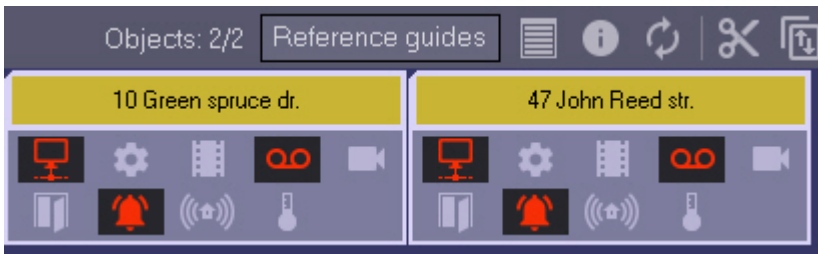

You can learn the meaning of the icons by clicking the button  (**Legend information**). When you click this button, the **Definitions** window opens.

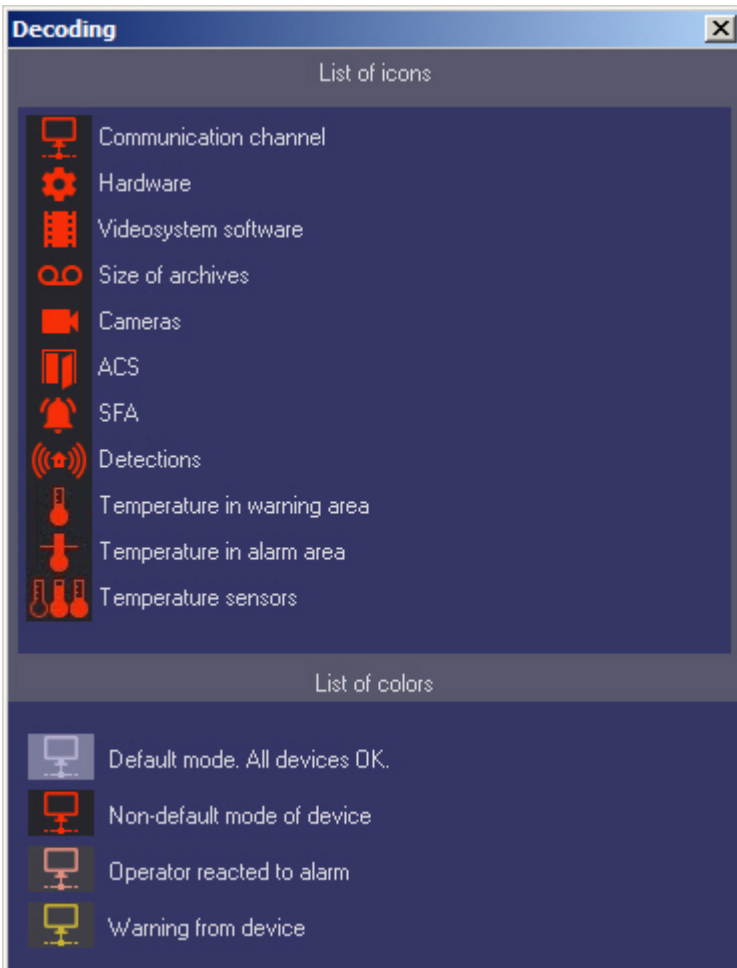

Changing alarm group icons

Rus

You can change the default icons for each alarm group and assign your own icons. To change an icon, replace the corresponding default picture file in the package. You can find the files in the Bmp subfolder of *Monitoring's* installation folder. The default path to the folder with pictures is C:\Program Files\Intellect\VHost\Bmp. For example, to change the icon for the Communication Channel group, replace two files:

1. Bmp\Active\01_net_active.bmp;
2. Bmp\InActive\01_net_inactive.bmp.

The size of icons is 33x23 pixels. If the size of your image is different, it will be changed to the above.

After you replace graphic files, restart *Intellect*. If at least one of the files is missing from the Bmp folder or has illegal format, the default icons are used.

Current display time

Rus

The information in the Control Panel is refreshed every time data is loaded from the database. The current view time (CVT) is shown in the window's upper-right corner.

CVT: 20.06.2018 13:37:44

Periods of information updating in the interfaces can vary for particular alarm types – see [Appendix 1. Data update periods summary](#).

To get the latest database information, click the button  (**Refresh data**). This forces the data to load. If new data is found, it is shown.

Ignoring objects

Rus

You can put the objects that must not be shown on the ignored objects list. For example, these can be objects that were created on *Monitoring's* server, but not launched yet or objects that are known for sure to be under maintenance at the moment.

The objects on the ignored objects list are not shown in the Control Panel or Log Panel. They are also not included in system reports.

To move an object to the ignored objects list, press the Shift key and left-click on one or multiple objects. The selected objects are now highlighted with a blue border.

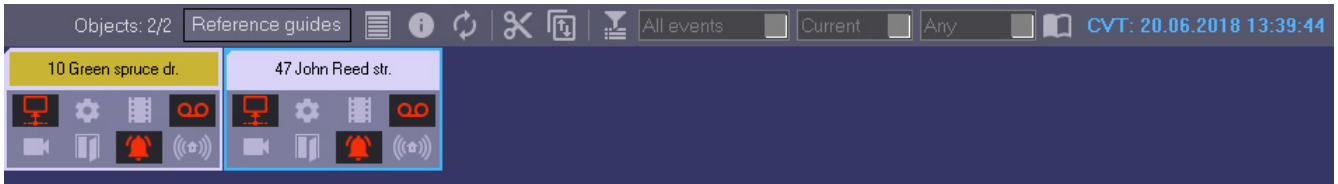

Then click the button  (**Ignore/Analyze**).

You can see the ignored objects list by clicking the button  (**Show ignored objects**).

Use the same actions to move objects back from the list.

Processing alarms

Confirming alarms

Rus

Information: in the event of an alarm, a button becomes red; when an operator confirms the alarm, it becomes pink, and after the alarm is over, the button gets back to the inactive state. You can use the buttons of alarm indicators both to get information and perform an action:

1. Action: By clicking a button, the operator gets details for the device or event.

For example, if a camera is broken, the indicator button for the **Cameras** alarm group becomes red.



To get the details about an alarm, click the alarm's icon. The **Reaction to alarm** window opens.

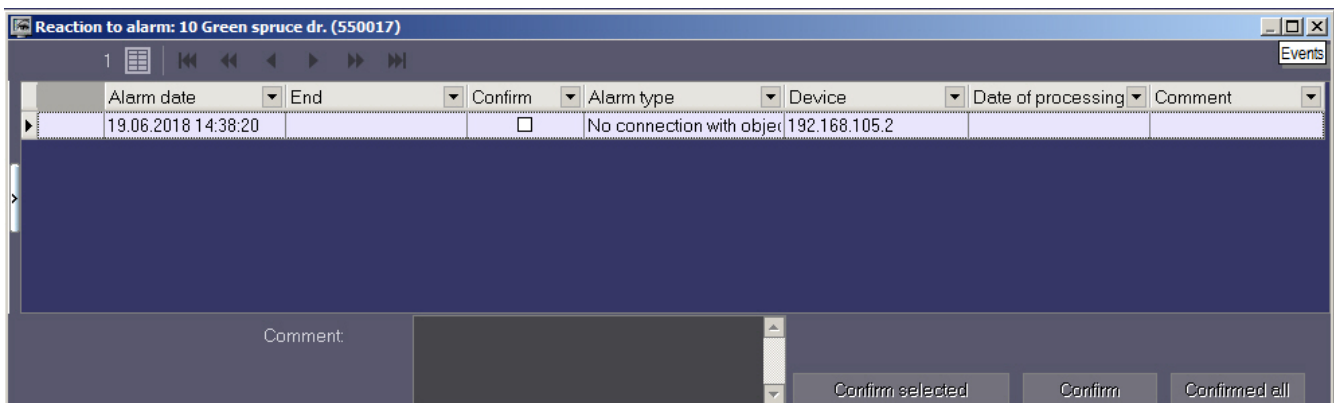

The title of the window contains the selected object's name and ID.

In the **Alarm date** field, the time when *Server of Control* had loaded the alarm from *Agent of Control* to the database. This is not the time when the alarm appeared on the *Agent of Control*. For more information on data transmission see section [Appendix 1. Data update periods summary](#).

The **Alarm type** field contains the name of the alarm, and the **Device** field gives details on the device or event.

If you check the **Confirm** box in the **Reaction to alarm** window, the icon's background in the Control Panel changes from red to orange and the **Processing date** column is automatically filled.



Note that the **Processing date** column will contain not the current computer time, but the current display time (see the [Current display time](#) section) stored in the database. This ensures that the operator cannot roll back the system time to confirm the alarm with a different time.

If when configuring the **Monitoring** interface object, you check the **Non-empty Comment field** check box, alarms are not closed until an operator comments on them or his/her actions. Any alarm is closed automatically after its cause is resolved (for example, the connection was broken and then restored).

If a complex confirmation of alarm acceptance is configured, then an additional dialog box appears. To confirm the alarm acceptance click the **OK** button, to cancel the action click the **Cancel** button.

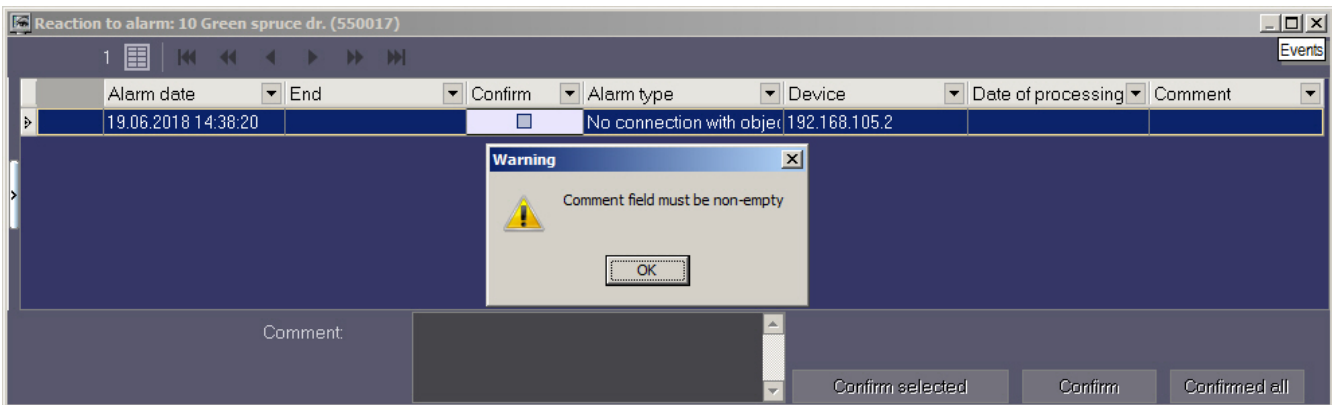

Confirmations of alarms that have been automatically accepted by the *Server of Control* are not sent.

Note.

If the operator does not accept a short alarm for 5 days, it is accepted automatically.

If you have many alarms at the same time, not more than 1000 alarm events are shown in the **Reaction to alarm** window. To view other events, use the navigation buttons in the lower-right corner.

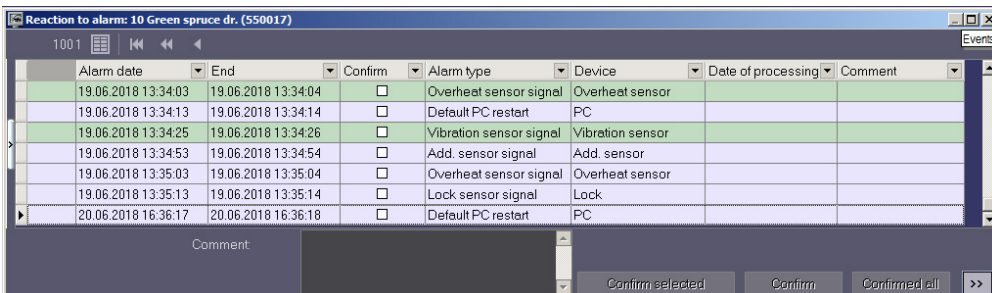

Confirming multiple same-type alarms

Rus

To accept several alarms, or all alarms of an object, or all alarms of all objects, simultaneously, do the following:

1. Click the icon that is informing about the alarm. The **Reaction to alarm** window opens.

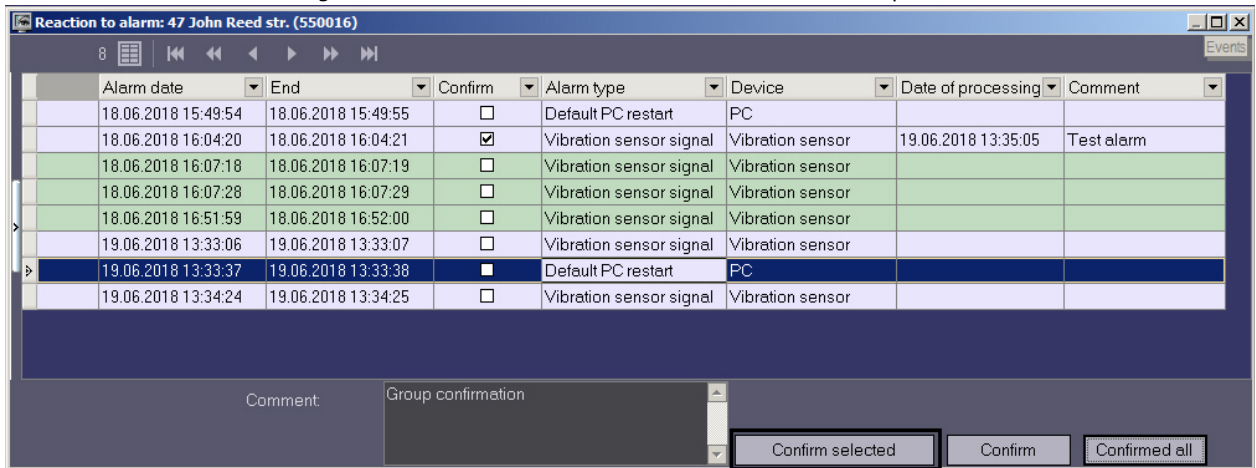

2. To accept several similar alarms, proceed as follows:
 1. Select several alarms from the list in one of the following ways:
 1. Use the left mouse button and the Ctrl or Shift key.
 2. Right-click on the list and click **Select all** item in the menu.

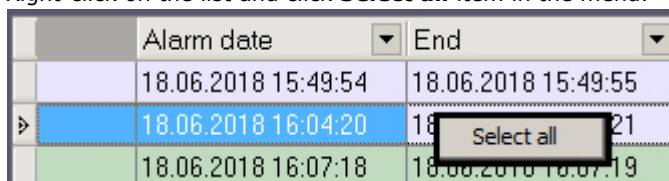

2. Fill in the **Comment** field if necessary.
3. Click **Confirm selected**.
3. To accept all alarms of an object, click **Confirm**. A dialog box displays to confirm the action. Click **Yes**.

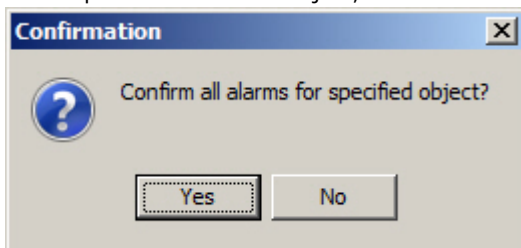

4. To accept all alarms of all objects, click **Confirm all**. A dialog box displays to confirm the action. Click **Yes**.

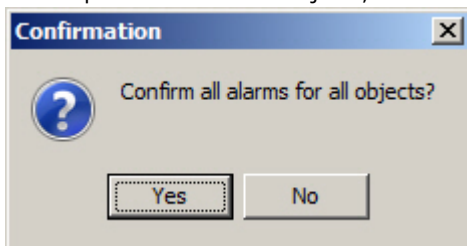

Note.

If a comment is required but the **Comment** field is empty, the **Confirm selected**, **Confirm** and **Confirm all** buttons are inactive.

Multiple alarms are now confirmed.

If a simple confirmation of alarm acceptance is configured, then only one confirmation is sent to the *Agent of Control* when a group of similar alarms is accepted on the *Server of Control*. If there should be a complex confirmation, then several alarms of the same type cannot be accepted. Each alarm is to be processed individually.

If all alarms of one or all objects are confirmed, simple or complex confirmation settings are ignored and no confirmation is sent to the *Agent of Control*.

Additional information on alarms

Rus

You can get additional information on alarms by clicking on the object name.



The **Error decoding** window opens.

Beginning	End	Duration	Reason, device	From 19.06.2018 14:17:55 to 20.06.2018 16:51:22 dow...
19.06.2018 14:17:55	20.06.2018 16:36:37	1 02:18:42		
20.06.2018 16:44:38	20.06.2018 16:46:37	0 00:01:59	Software error (Basic software	
20.06.2018 16:51:04	20.06.2018 16:51:22	0 00:00:18	No connection with object (192	

Alarms caused by different reasons can overlap, creating common alarm periods for the object. In the table, they are shown in gray. If an alarm is still active, its **End** column is empty.

If there are too many alarms, not more than 200 alarms are shown in the **Error decoding** window. To view other events, use the navigation buttons and the additional tool **View from date** in the lower-right corner.

Alarm types

Rus

The following table contains all the alarm types that are controlled by the monitoring system by default. For **Communication channel** alarm group: if *Agent Of Control* connects to *Server of Control* via the TCP/IP protocol and it has connected to it before, the **Device** field shows the object's IP address.

Alarm group	Alarm type	Device	Comment
Communication channel	No connection with the object	Communication channel	<i>Agent Of Control</i> connects to <i>Server of Control</i> in client mode
	No connection with the monitoring agent	Local video system	<i>Agent Of Control</i> connects to <i>Server of Control</i> in server mode
Hardware	Disk failure	101:Disk name	<i>Intellect</i> 's settings contain the names of the disks to record video archive on. This alarm occurs when one of these disks does not exist or has the wrong type. The correct type for a disk: fixed, removable, or network.
		102:Disk size	Error when computing the free disk space
		103:VIDEO folder	The VIDEO folder is not present
		104:Number of disks=0	No disks were selected in <i>Intellect</i> for recording the video archive.
		105:Disk error	An unknown disk error was received from <i>Agent Of Control</i>
	UPS signal	1000:PowerChute started	
		1001:PowerChute stopped	
	1002:Connection restored		
	1003:Power restored		
	1004:Self-Test passed		
	1005:Administrative shutdown		
	1006: Shutdown canceled		
	1007:Battery charged		

		1009:Battery changed 1013:Allowed overload 1014:RTC Started 1015:RTC Finished 1016: Shutdown in process 1102:Normal temperature 2000:Power is off 2001:Shutdown performed 2002:Low power 2003:Battery discharging 2004:RTC Aborted 2007:High power 3000:Connection lost 3001:Overload 1004:Self-Test not passed 3003:Battery discharged 3004:Connection lost - battery 3016:Change battery 3107:High temperature	
Video system software	Software error	Core software	intellect.exe unloaded
		Base software (video)	video .run unloaded or hanging
		Registry	The registry does not have the data necessary for <i>Agent Of Control</i> to work
		Database	Error when connecting to the <i>Intellect</i> database
Size of archives	Small archive size	Archive 1 ... Archive 32	The archive depth requirements are not met for camera # 1..32. If an object has more than 32 cameras, create an additional Partition of Control on <i>Agent Of Control</i> .
Cameras	Camera is off	Camera 1 ... Camera 32	Camera # 1..32 is not working. If an object has more than 32 cameras, create an additional Partition of Control on <i>Agent Of Control</i> .
FSA	Vibration detector signal	Vibration detector	The four sensors that cannot be renamed on <i>Agent Of Control</i> i. e. they must be used according to their names (Vibration detector, Lock, etc.).
	Lock sensor signal	Lock	
	Overheat detector signal	Overheat detector	
	Additional sensor signal	Additional sensor	
	Additional sensor signal	EXT. SENSOR	12 sensors whose names must be renamed on <i>Agent Of Control</i> These names are shown in the Device column. By default, the following line will be shown: EXT. SENSOR
	Computer restarted normally	Computer	Logged off from Windows normally before restarting

	Computer restarted abnormally	Computer	The computer was restarted without logging off from Windows correctly (power off)
Thermal sensors	Thermal sensors are off	Set of thermal sensors	The adapter (DS2480B) that processes information from the thermal sensors is down.
	Temp.: warning	Set of thermal sensors	A thermal sensor's (DS18S20) temperature is close to the temperature that causes an alarm. The indicating button is yellow.
	Temp.: alarm	Set of thermal sensors	A thermal sensor's (DS18S20) temperature reached the temperature that causes an alarm.

Note.

Periods of information updating in the interfaces can vary for particular alarm types – see [Appendix 1. Data update periods summary](#).

The alarms tracked by the monitoring system can be of two types:

1. Long-term.
2. Short-term.

Long-term alarms are alarms that have a start and end time (for example, **Camera is off/Camera is on, No connection with object/Connection with object**).

Short-term alarms have no duration. They inform about occurred events, such as **Vibration detector triggered** or **Computer restarted normally**. These alarms are not included when the system's performance indicators are calculated.

Alarms that are configured as described above (in the abandoned object detector example) are always short-term. For short-term alarms, the **Ended** field is immediately filled with a time shifted by one second from the alarm detection time. Confirmed short-term alarms are shown in the Control Panel for 10 minutes. Long-term alarms include the following alarm types:

- No connection with object;
- No connection with monitoring agent;
- Disk failure;
- Software error;
- Small archive size;
- Camera is off;
- Thermal sensors are off.

Defining user alarm types

Rus

For the **ACS** and **Detections** alarm groups, by default no data is sent from *Agent Of Control*. These alarm groups, as well as **Hardware** and **FSA**, can be used for designating their respective alarm types. For how to define user alarm groups, see the document [Monitoring. Administrator's Guide](#).

Configuring the Displayed Number of Alarms

Rus

The number of objects shown in the Control panel is defined by the current filter. You must enable the filter by clicking the

button  (**Turn filter on/off**). The first drop-down list defines condition for filtering by alarms, failures, presence or absence of connection; the second drop-down list defines the condition *Show only objects with errors for last...*; and the third one defines the condition *Show only objects with errors lasting longer than...*

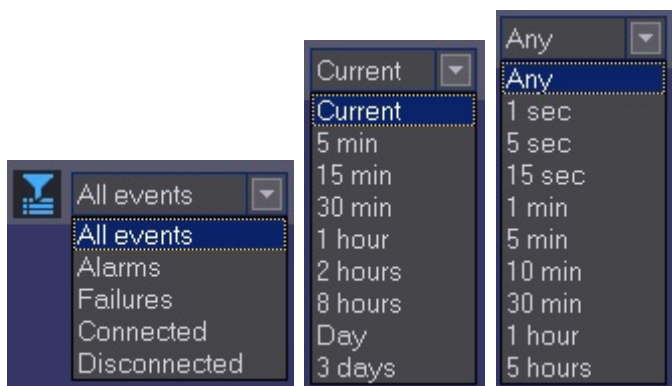

In the window's upper-left corner, you can see the two numbers: 1) the total number of objects and 2) the number of objects shown in the Control Panel after you click the  button.

Objects: 2/2 Reference guides

Viewing video data on alarms

Indication of video data presence

Rus

In *Monitoring* software, the alarms can be followed by video data, such as video clips and video frames.

If there are loaded but not viewed yet video data, the name of the object on the Control panel is colored in orange.



Viewing video data

Rus

To view all received video data, select the **Video data** item in the object context menu.

Note.

Depending on the *Monitoring* software settings (see [Monitoring. Administrator's Guide](#)) the received video frames and video clips can be automatically opened immediately after they have been received.

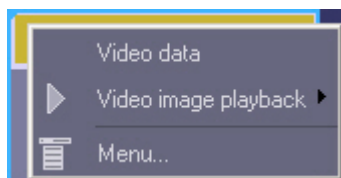

The **Video data** dialog box opens. The information on video data is displayed in this dialog box. This dialog box also provides function to cancel data downloading, if it has not been completed yet, using the **Cancel loading** button.

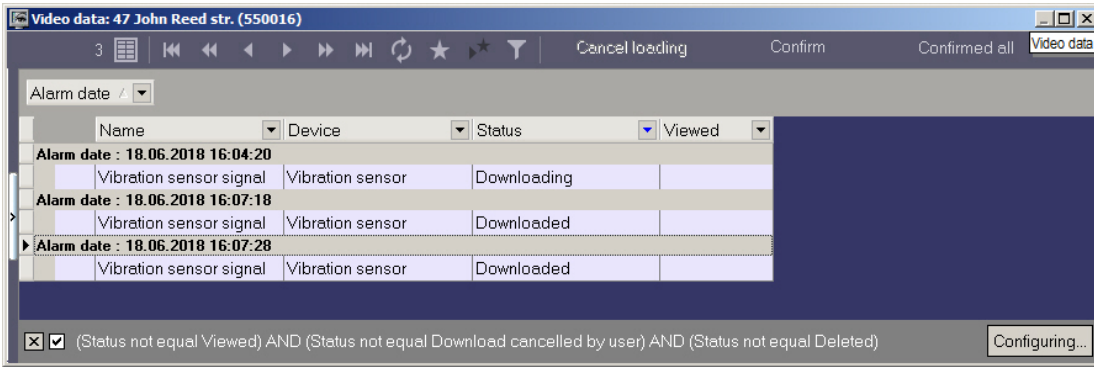

To force an update of the information in the **Video data** dialog box, click the .

To open the loaded video data right-click in the row corresponding to required data and select the **View** item. If the data download is not completed, this item is inactive.

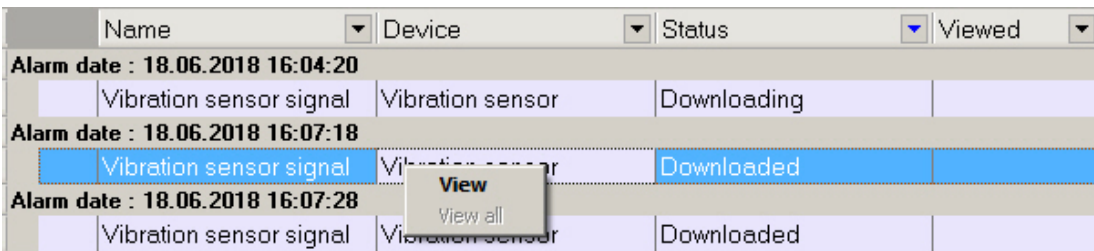

When the **View** item is selected, a video frame is opened with utility selected at the *Monitoring* setup and a video clip is opened with *Axxon Player* utility. Video data status changes to "Data viewed" and in the **Viewed** column the date of viewing is displayed.

If video data export fails, then there is the **Archive export error** message in the **Status** column.

Name	Device	Status	Viewed
Alarm date : 2/9/2015 1:35:56 PM			
Detections	Detection triggered	Archive export error	
Alarm date : 2/9/2015 1:37:06 PM			
Detections	Detection triggered	Downloaded	

To cancel download of "Downloading" or "Archive export error" data click **Cancel loading**. After that, the status of the video data becomes "Download cancelled by user" and it is not displayed in the list if default filter is enabled (see [Setting video data list filter](#)).

To mark all object's video data as viewed, click **Confirm**. To mark all video data of all objects as viewed, click **Confirmed all**. A dialog box for action confirmation for one or all objects is shown. Click **Yes** to confirm.

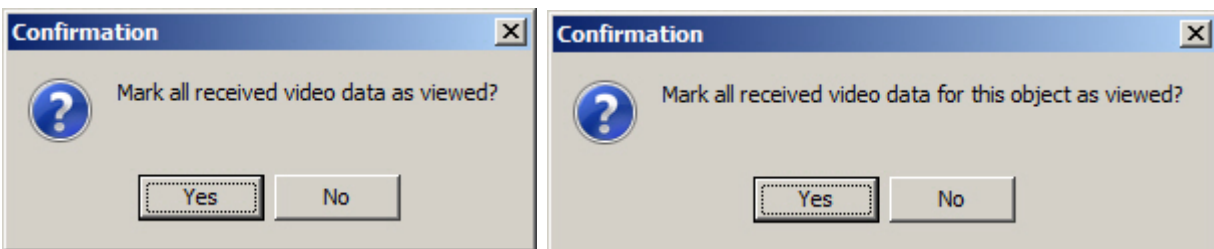

As a result, the name of the object stops being of yellow color. Status of all video data changes as follows and they are not displayed in the list of video data if the default filter is enabled (see [Setting video data list filter](#)).

- "Downloaded" to "Viewed"
- "Archive export error" to "Download cancelled by user"

Video data grouping setup

Rus

By default, video data are grouped by alarm time. If necessary, it is possible to set video data grouping by other parameters. To do so, in the context menu of a column, by which one need to group the data, select **Group by** field.

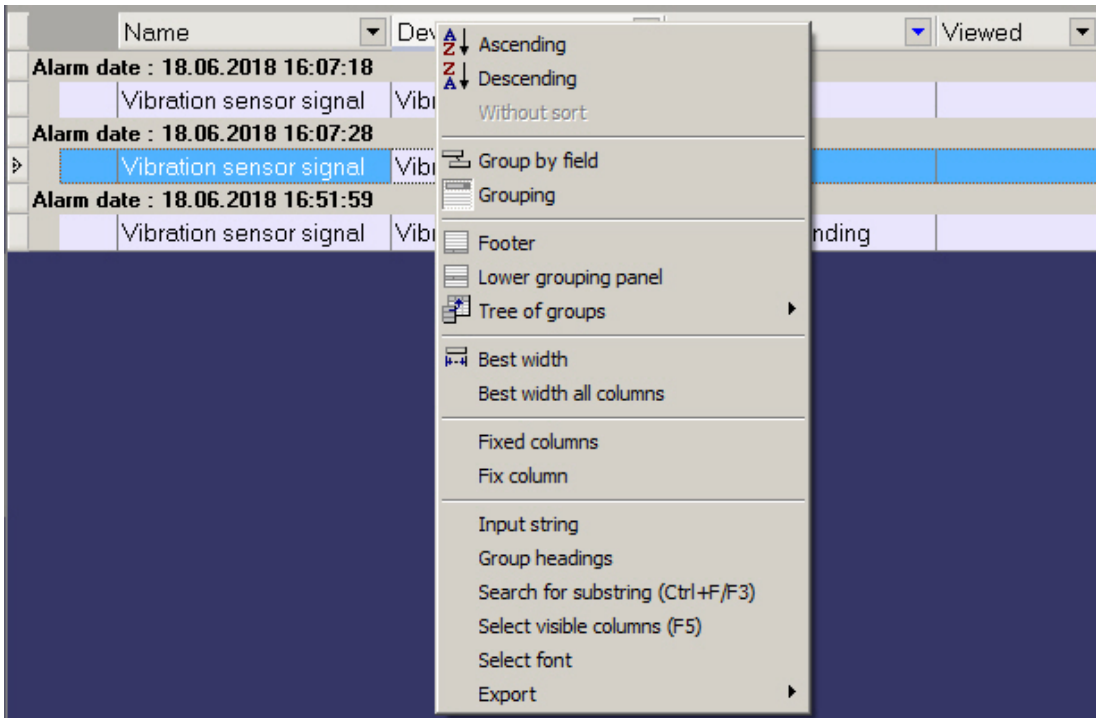

Data will be grouped by selected field. In the upper part of the dialog box the fields by which the video data are grouped are displayed - a grouping area. To view this area one can also select the **Grouping** item in a column context menu.

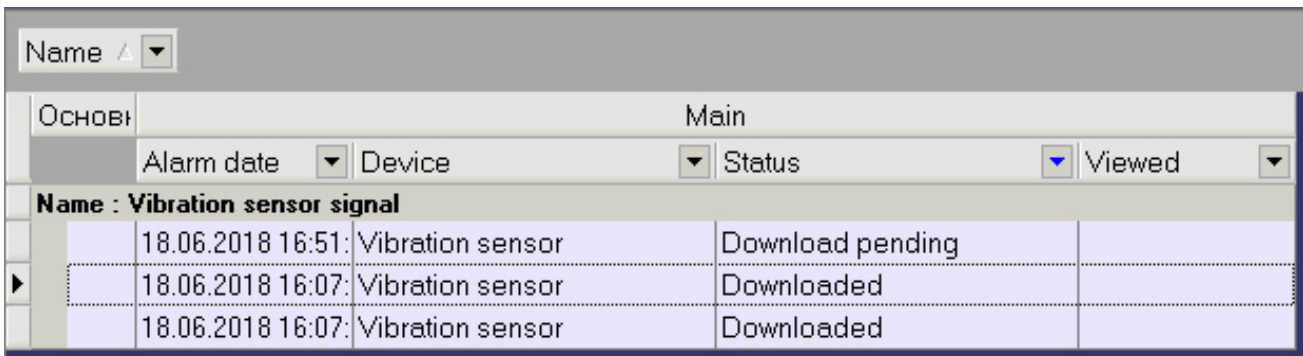

To cancel grouping by a field, right-click on it and select **Remove from grouping**.

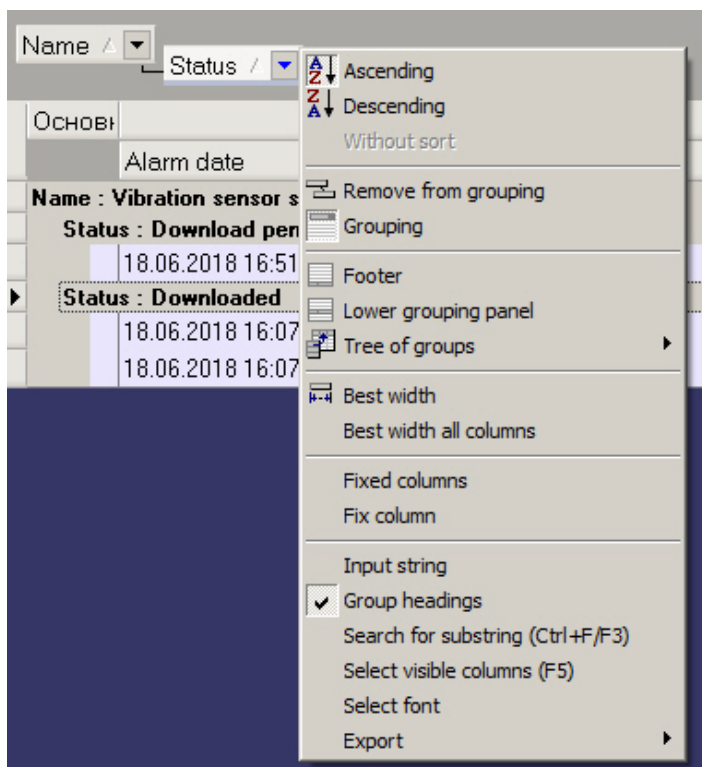

Setting video data list filter

Rus

By default, in the **Video data** dialog box the data are not displayed, which has been viewed or for which downloading has been canceled by a user. To display all the video data, unset the checkbox in the lower left corner of the **Video data** window.

It is also possible to setup the filter for video data displaying. To open the filter setup dialog box, in the **Video data** dialog box click **Configuration...** or . The **Filter creator** dialog box opens.

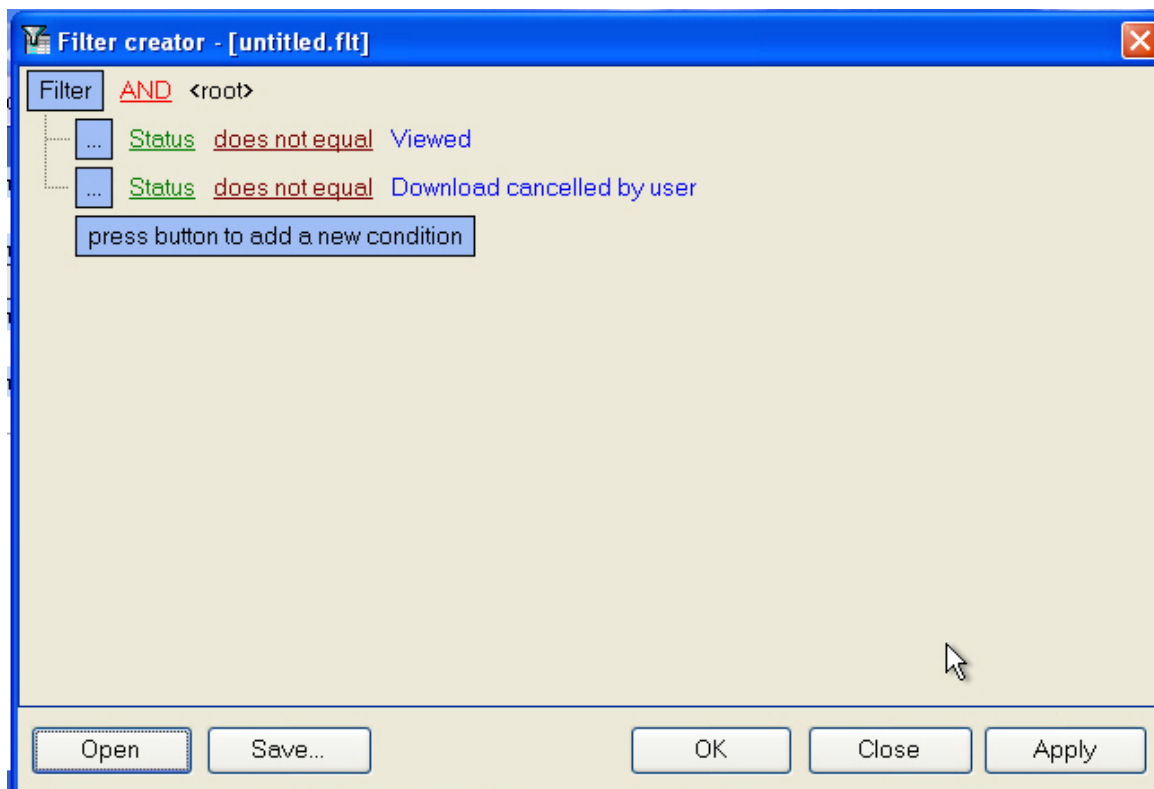

When configuring the filter, one may need to perform the following operations:

1. Add a condition or subcondition. To add a condition click the **click to add a new condition** button or in the filter menu click the corresponding item. The condition menu opens by clicking the ... or **Filter**.

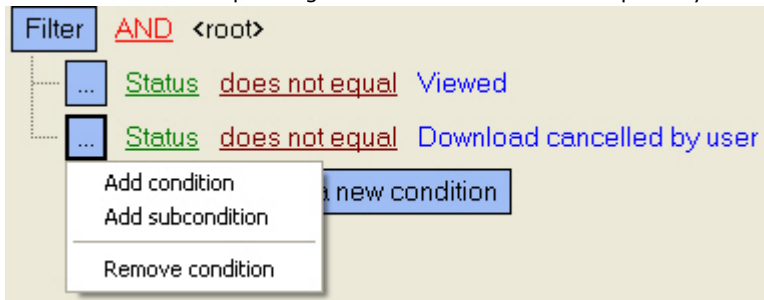

2. Remove a condition. To remove a condition, click the corresponding item in the condition menu.
3. Select a logical function for combining conditions. A drop-down list for selecting the logical function opens on the left-click on the logical function.

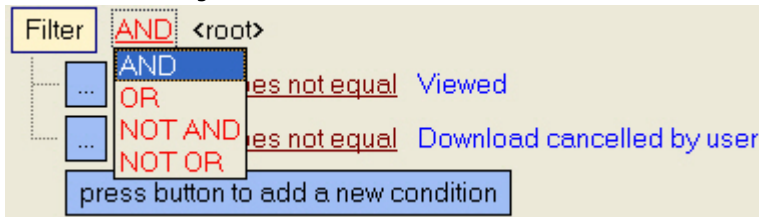

4. Select a field for comparison. A drop-down list for selecting the field for comparison opens on the left-click on the field name.

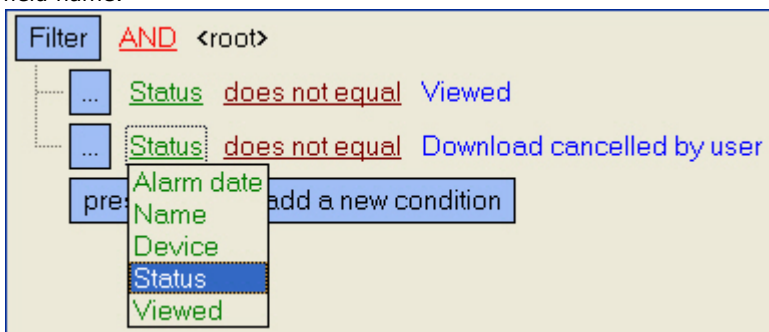

5. Select a method of comparing. A drop-down list for selecting the method of comparing opens on the left-click on the method name.

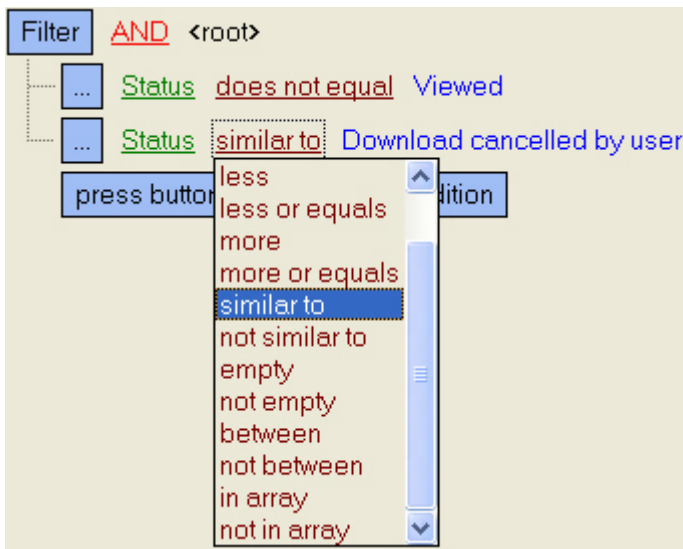

6. Select a value for comparing with. A way to select the value depends on the field type. For example, a date can be set using a calendar, a name can be entered in a field, etc.

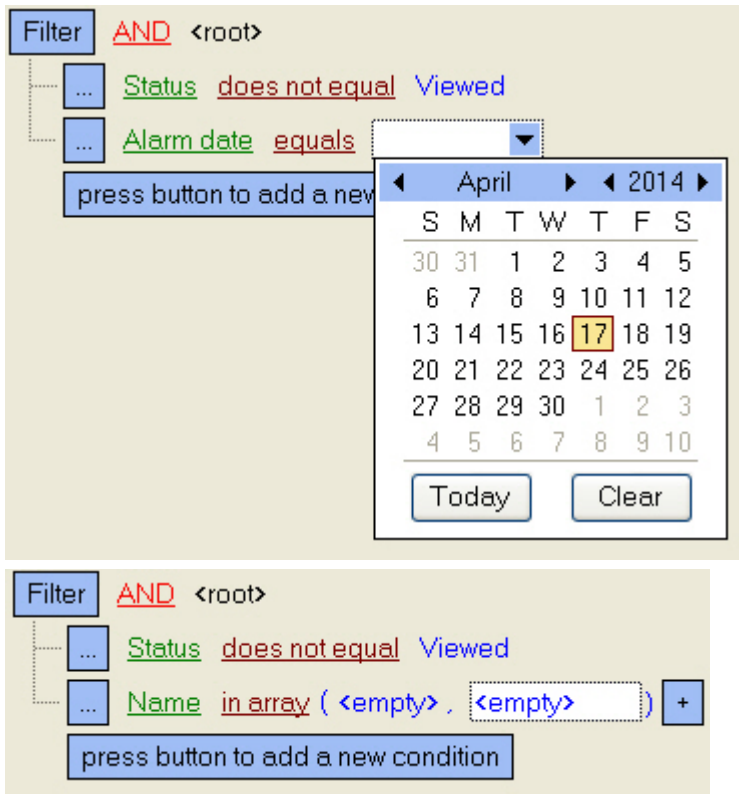

After completing settings, the filter can be saved to a file with the .flt extension by clicking the **Save...** button. This file can then be opened using the **Open** button.

Event log

Rus

To view all the events registered in *Monitoring*, click the button  (**Event log**). The **Event log** window opens. You can sort and filter this table by any column.

ID	Alarm date	End	Name	Region	District	City	Confirm	Alarm type	Device
550017	22.06.2018 17:47:27	22.06.2018 17:47:28	10 Green spruce dr.				<input type="checkbox"/>	Lock sensor signal	Lock
550016	22.06.2018 17:48:08	22.06.2018 17:48:09	47 John Reed str.				<input type="checkbox"/>	Default PC restart	PC
550017	22.06.2018 17:48:08	22.06.2018 17:48:09	10 Green spruce dr.				<input type="checkbox"/>	Default PC restart	PC
550016	22.06.2018 18:12:33	25.06.2018 11:47:59	47 John Reed str.				<input checked="" type="checkbox"/>	No connection with obje	192.168.105.2
550017	22.06.2018 18:12:33	25.06.2018 11:47:59	10 Green spruce dr.				<input checked="" type="checkbox"/>	No connection with obje	192.168.105.2
550016	25.06.2018 11:49:40	25.06.2018 11:49:41	47 John Reed str.				<input type="checkbox"/>	Default PC restart	PC
550017	25.06.2018 11:49:40	25.06.2018 11:49:41	10 Green spruce dr.				<input type="checkbox"/>	Default PC restart	PC
550016	25.06.2018 14:50:20		47 John Reed str.				<input type="checkbox"/>	Archive size not enough	Camera 1
550017	25.06.2018 14:50:20		10 Green spruce dr.				<input type="checkbox"/>	Archive size not enough	Camera 2
550017	25.06.2018 14:50:20		10 Green spruce dr.				<input type="checkbox"/>	Archive size not enough	Camera 3
550017	25.06.2018 14:50:20		10 Green spruce dr.				<input type="checkbox"/>	Archive size not enough	Camera 4
550017	25.06.2018 14:50:20		10 Green spruce dr.				<input type="checkbox"/>	Archive size not enough	Camera 5
550016	25.06.2018 18:30:34		47 John Reed str.				<input type="checkbox"/>	No connection with obje	192.168.105.2
550017	25.06.2018 18:30:34		10 Green spruce dr.				<input type="checkbox"/>	No connection with obje	192.168.105.2

Display from date: 20.06.2018

Note.

If the Owner Panel is in use, then events from the objects that belong to the owner selected on the Owner Panel are displayed in the **Event log** window. To view the events from all system objects, call this window on the Owner Panel – see [Viewing Event log for all objects](#).

Viewing comments

Rus

If an operator enters a multi-line comment when he closes an alarm, only the first line is shown in the **Comment** column in the **Event log** window.

To view the entire comment, left-click the "up" and "down" arrows in the cell.

Date of processing	Comment
26.06.2018 12:10:29	The engineer is

User that confirmed an alarm

Rus

By default, all the alarms confirmed by an operator are registered by the Admin user. However, a user with certain privileges can be created in the **Users** tab. Then, when an operator starts *Intellect* using this user's account, all the confirmed events are registered using this user.

Event display period

Rus

By default, the alarms for the current day are shown. To view earlier events, use the **View from date** drop-down list.

ID	Alarm date	End	Name	Region	District	City	Confirm	Alarm type	Device
550016	25.06.2018 11:49:40	25.06.2018 11:49:41	47 John Reed str.				<input type="checkbox"/>	Default PC restart	PC
550017	25.06.2018 11:49:40	25.06.2018 11:49:41	10 Green spruce dr.				<input type="checkbox"/>	Default PC restart	PC
550016	25.06.2018 14:50:20		47 John Reed str.				<input type="checkbox"/>	Archive size not enough	Camera 1
550017	25.06.2018 14:50:20		10 Green spruce dr.				<input type="checkbox"/>	Archive size not enough	Camera 2
550017	25.06.2018 14:50:20		10 Green spruce dr.				<input type="checkbox"/>	Archive size not enough	Camera 3
550017	25.06.2018 14:50:20		10 Green spruce dr.				<input checked="" type="checkbox"/>	Archive size not enough	Camera 4
550017	25.06.2018 14:50:20		10 Green spruce dr.				<input type="checkbox"/>	Archive size not enough	Camera 5
550016	25.06.2018 18:30:34		47 John Reed str.				<input checked="" type="checkbox"/>	No connection with object	192.168.105.2
550017	25.06.2018 18:30:34		10 Green spruce dr.				<input type="checkbox"/>	No connection with object	192.168.105.2

Display from date: 25.06.2018

If the number of events exceeds 1000, use the navigation buttons for viewing.

Exporting the event log

Rus

To export the event log, open the context menu for a column of the table in the **Event log** window.

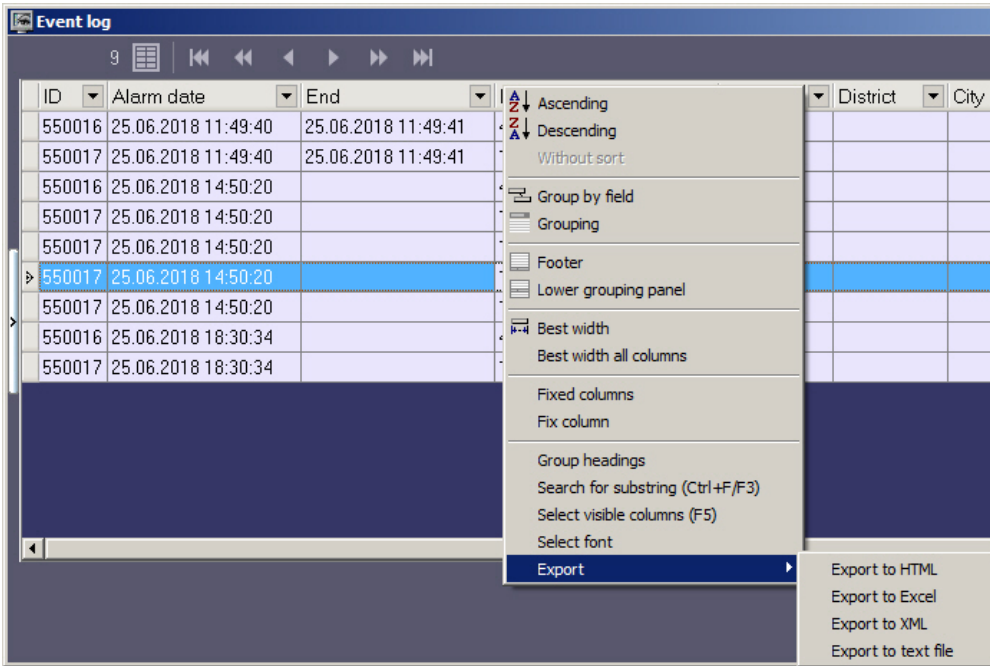

Configuring the position of the event log's columns

Rus

The columns' context menu contains the **Best width all columns** command. Select this command to set such a width for each column that fits all the column's content.

If not all the columns are visible in the **Event log** window, a scrolling GUI element appears. When you scroll, the columns that must be visible all the time (for example, **Alarm date**, **Processing date**) are moved. To lock the position of such columns, use the **Fix column** command from the same context menu.

You change the position of the columns. To do that, click on the heading of the column that you want to move and drag it to another place.

Regulatory and reference information

Viewing regulatory and reference information

Rus

Monitoring keeps regulatory and reference information for all objects. To view this information, click **Reference guides** and select the **Monitoring objects** menu item.

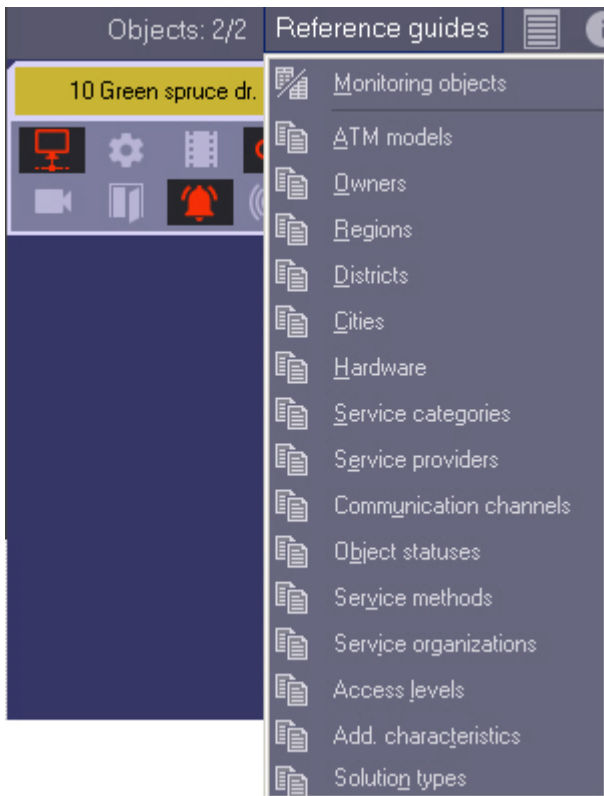

The **Monitoring objects** window opens. It contains all the objects created in the system.

ID	Object c	Name	Location	Region	District	City	Object	Enter	Remov	Status	Owner	M
550017	2	10 Green spru	10 Green spru					18.06.20				
550016	1	47 John Reed	47 John Reed					18.06.20				

Editing regulatory and reference information

Rus

If you double click on a record, a form opens. Here you can fill in regulatory and reference information for the object.

Record	
Object code	2
Name	10 Green spruce dr.
ID	550017
Location	10 Green spruce dr.
Region	
District	
City	
Object	
Entered	18.06.2018 15:01:51
Removed	
Model	
Access	
Add. characteristic	
Solution type	
Type of connection with object	
Service provider	
Owner	
Hardware	
Status	
Service category	
Service method	
Service company	

Some fields offer default values and some do not. This means that the corresponding reference book is empty and it must be filled out (see the [Filling out reference books](#) section).

Filling out reference books

Rus

To fill out a reference book:

1. Click **Reference guides**. A window opens. In the window, select the required reference book (for example, **Owners**).

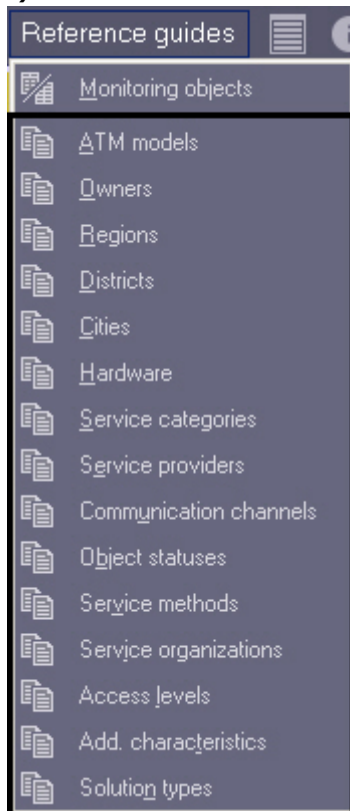

2. Then, the editing window for the reference book opens.

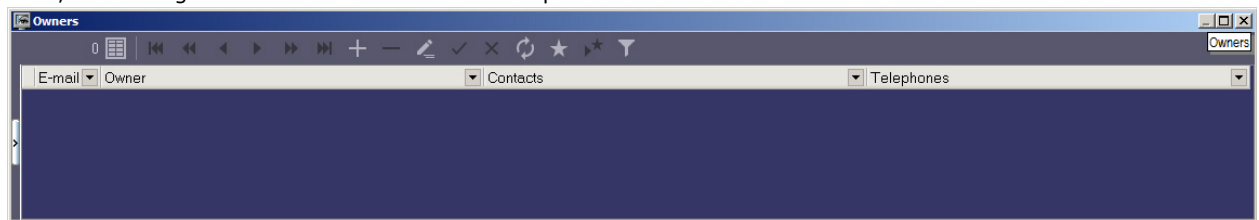

3. To add an entry, click **Insert entry** and enter the value.

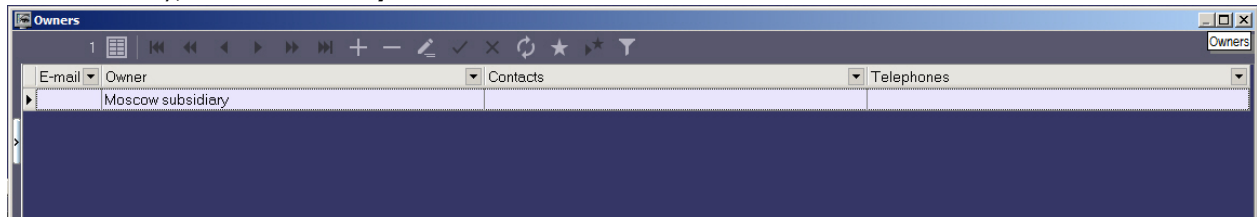

4. Click **Save**.

You can edit any reference book like this.

After you add a value to a reference book, you can use it for filling in the corresponding field for regulatory and reference information.



Column context menu in the Monitored objects window

Rus

Right-click on the heading of any column in the **Monitoring objects** window. A context menu opens. You can use this menu for different actions, in a way similar to the actions with the event log (see [Exporting the event log](#) and [Configuring the position of the event log's columns](#)).

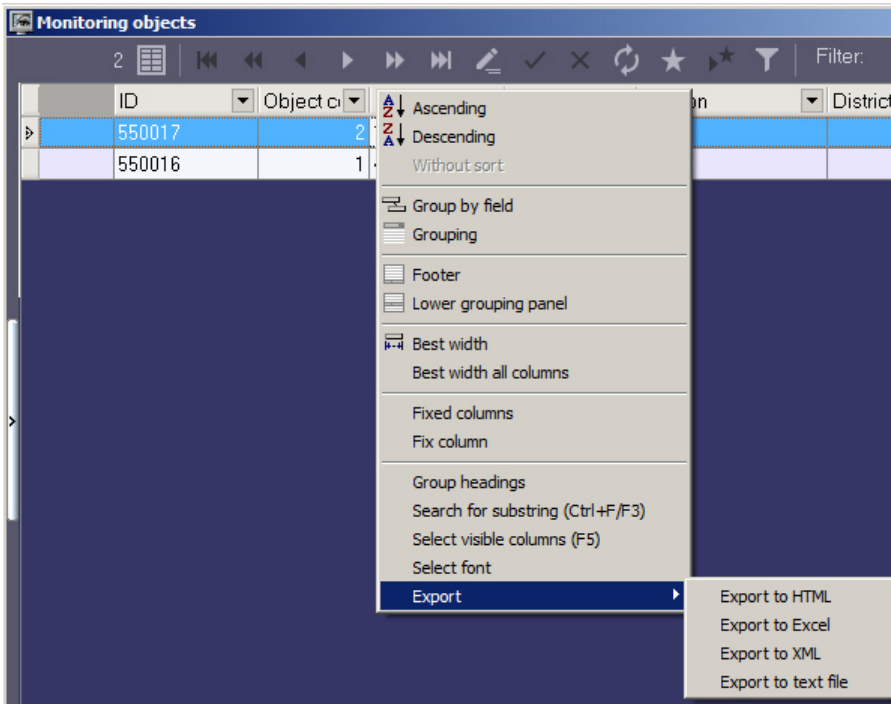

Viewing objects' live video and archives

Rus

One can playback both live video and archives from objects on the Control Panel:

1. Playing back video from a specific camera.
2. Playing back video from all cameras created at the Agent of Control.
3. Creating user layouts and playing back video from selected cameras added to the Partition of Control.

Note.

Information on how to select cameras for live video and archives playback on the Control Panel can be found in [Configuring the camera list](#) section of [Administrator's Guide](#).

To select the mode for playing back live video and archive right click the area with object name. Select the **Video image playback** item in the context menu. To play back video

To play back video from a specific camera select the name of corresponding camera in the menu; to play back video from all cameras select the **All cameras** item and to select the user layout select the **Displays** menu item. Find more details on how to play back video image in the corresponding sections.

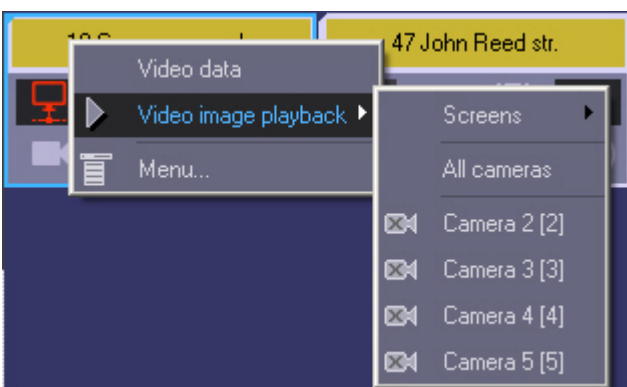

Note.

Camera names in the context menu as well as IDs specified in the square brackets correspond to those on the **Agent Of Control**.

The list of cameras corresponds to the list of cameras specified when configuring the **Agent Of Control** object. The **View video** menu item is available only after the object connects to **Monitoring** for the first time. Before that, there is no such menu item.

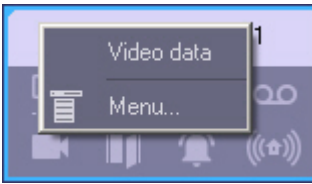

If the *Monitoring* software have the corresponding setting, then when the camera is selected for viewing live video the warning will be displayed saying that transmission of video can create critical load on the channel. If it is really necessary to view live video, click **OK** in the **Warning** dialog box. To cancel viewing live video, click **Cancel**.

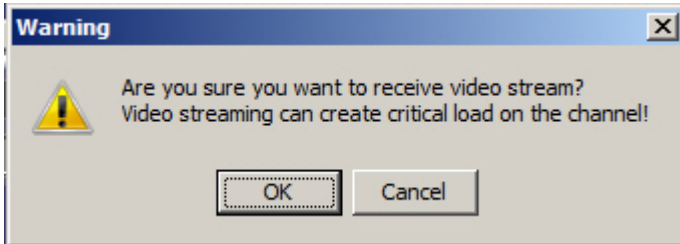

Playing back live video and archive from a specific camera

Rus

To play back live video and archive from a specific camera select the name of corresponding camera in the **Video image playback** menu of the Control Panel (see [Viewing objects' live video and archives](#)).

After you select a camera, a dialog box opens. Wait for several seconds for the video to start.

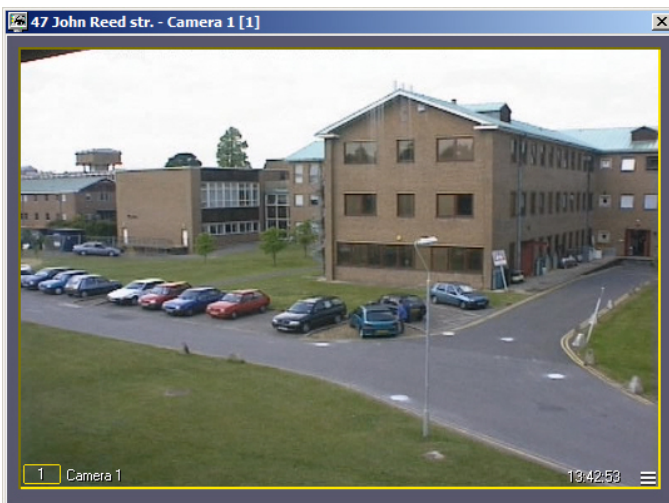

The window's title shows the description of the object, the camera sequence number, and the camera ID in brackets. The archive is accessed using Intellect's standard method.

Note.

For more details, see the document [Intellect software package. Operator's guide](#).

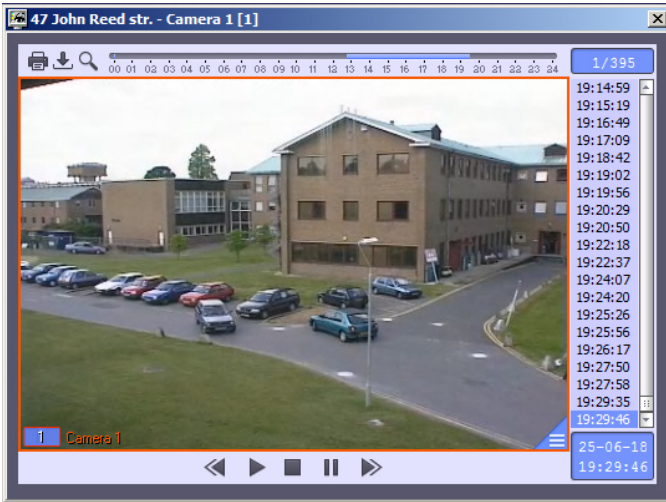

While viewing live video or archive from several cameras simultaneously, a separate dialog box opens for each camera.

To view live video in the full screen mode, double left click it. To exit the full screen mode and restore video mode, double right click the video.



Playing back live video and archive from all cameras

Rus

To play back live video and archive from all cameras select the **All cameras** item in the **Video image playback** menu of the Control Panel (see Viewing objects' live video and archives).

As a result the dialog box with viewing tiles for all cameras created at *Agent of Control* appears.



Use the  button in the bottom right corner of the viewing tile to enter the archive mode and the  button to exit the archive mode.

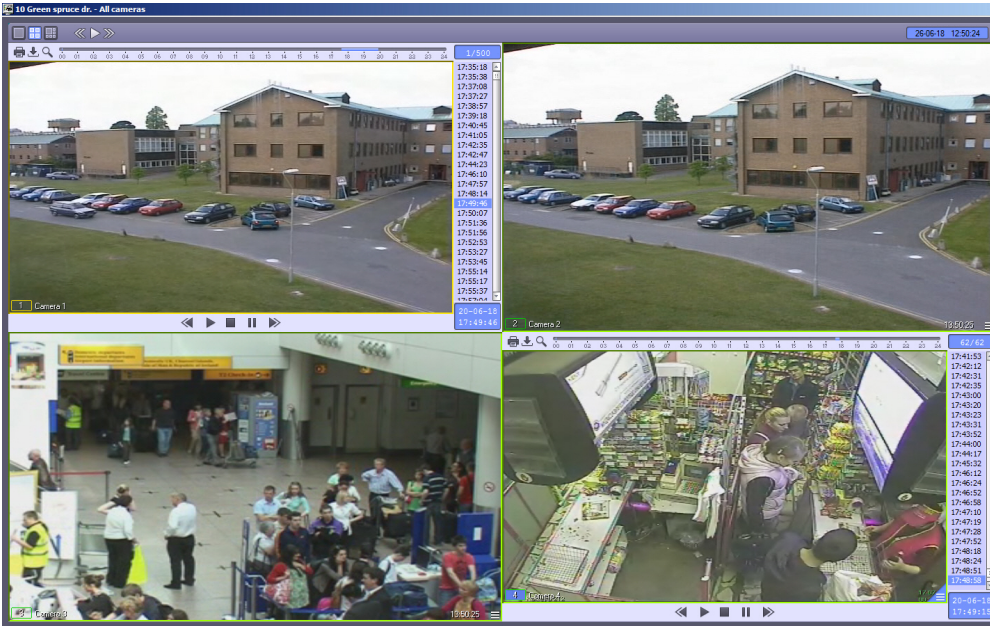

Live video and archive playback control functions are the same that those used in the Video monitor in *Intellect*. One can switch between viewing tiles as well as start manual and auto paging. Find details on these functions in *Intellect software package. Operator's Guide*. The latest version of this document is available in [AxxonSoft documentation repository](#).

Playing back live video and archive from selected cameras

Creating, editing and deleting layouts

Eng

On the page:

- Creating layout
- Adding camera to layout
- Deleting layout

Layout represents the list of cameras the user can select on the Control Panel in order to play back live video and archive (see [Viewing objects' live video and archives](#)).

Creating layout

Create a layout as follows:

1. Right click the object on the control panel and select **Video image playback -> Screens -> Create** in the context menu.

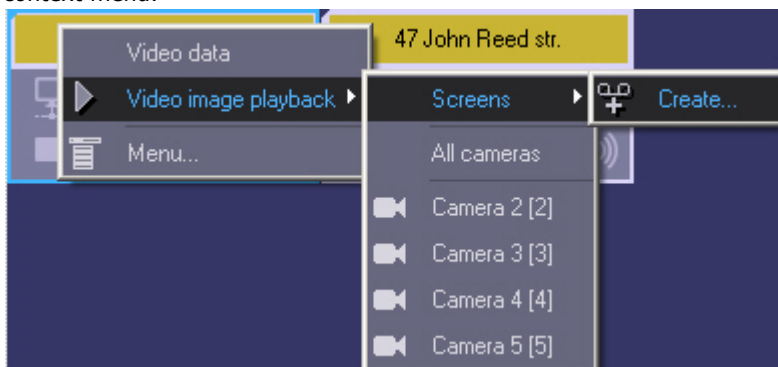

2. As a result the **Create...** window appears.

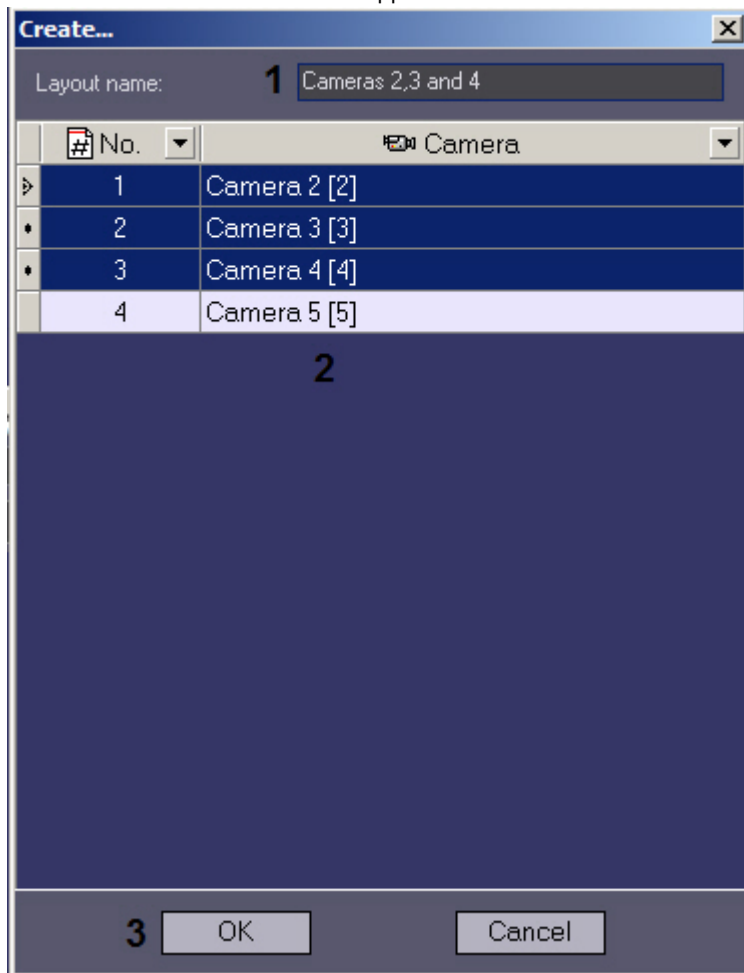

3. Specify the **Layout name** (1).

4. Select one or several cameras to be added to the layout. To select several cameras left click the corresponding lines in the table and hold down the Ctrl key on the keyboard (2).

The filter can be applied to the camera list. Click the  button in the column title and select the filter values:

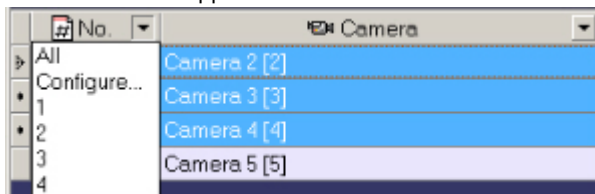

The **User filter** box appears when selecting the **Configure** item – one can set conditions to show cameras in the list.

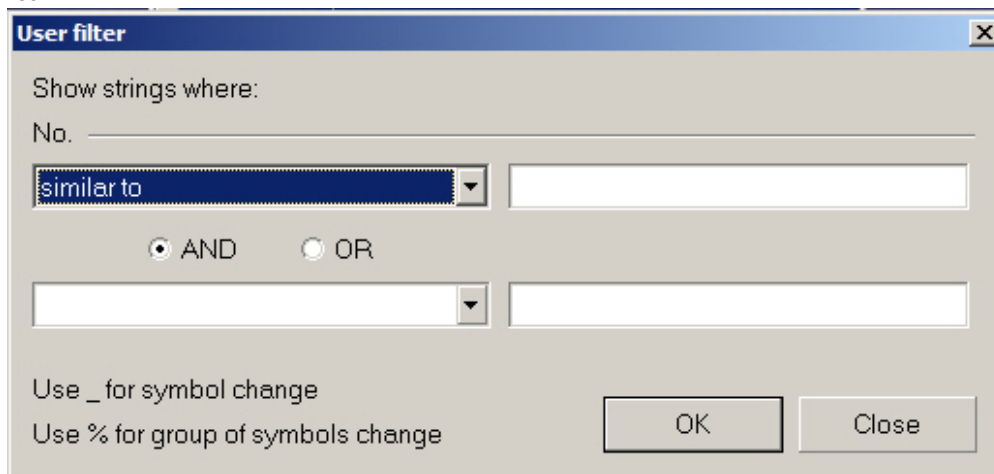

5. Click the **OK** button (3).

As a result the created layout is available in the **Video image playback -> Screens** menu.



The layout is now created.

Adding camera to layout

Add a camera to the layout as follows:

1. Right click the object on the control panel and select **Video image playback -> Screens -> Add camera** in the context menu.

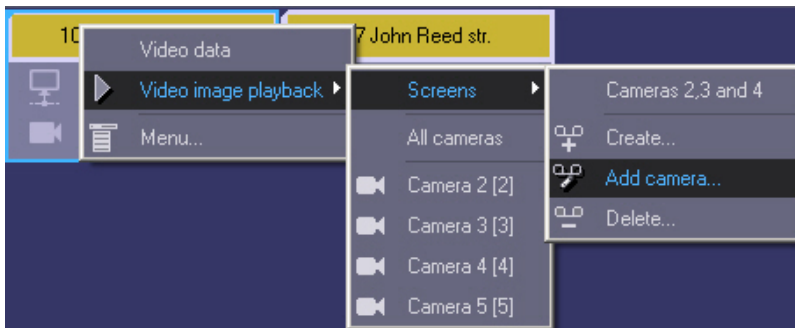

2. The **Add** window appears.

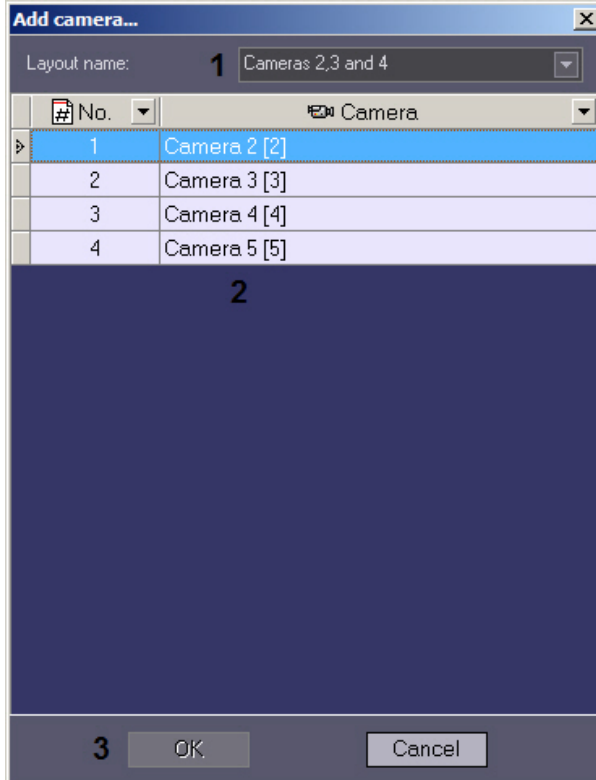

3. In the **Layout name** dropdown list select the layout the cameras are to be added to (1).
4. Select one or several cameras to be added to the layout. To select several cameras left click the corresponding lines in the table and hold down the Ctrl key on the keyboard (2).

Note.

The camera list filter can be applied the same way as when creating the layout – see *Creating layout* above.

5. Click the **OK** button.

Cameras are now added to the layout.

Deleting layout

Delete the layout as follows:

1. Right click the object on the control panel and select **Video image playback -> Screens -> Delete** in the context menu.



2. The **Delete...** window appears.

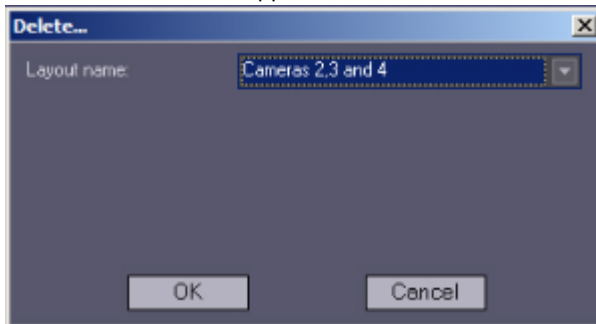

3. In the **Layout name** dropdown list select the layout that is to be deleted (1).
4. Click the **OK** button (2).

The layout is deleted.

Selecting layout for display

Rus

Select the layout that is to be displayed as follows

1. Right click the object on the control panel, select **Video image playback -> Displays** in the context menu and select the name of the required layout in the menu.

Note.

If there is no layout in the list, then create one– see *Creating, editing and deleting layouts*.



2. As a result the window to play back live video and archive from cameras added to the layout appears.

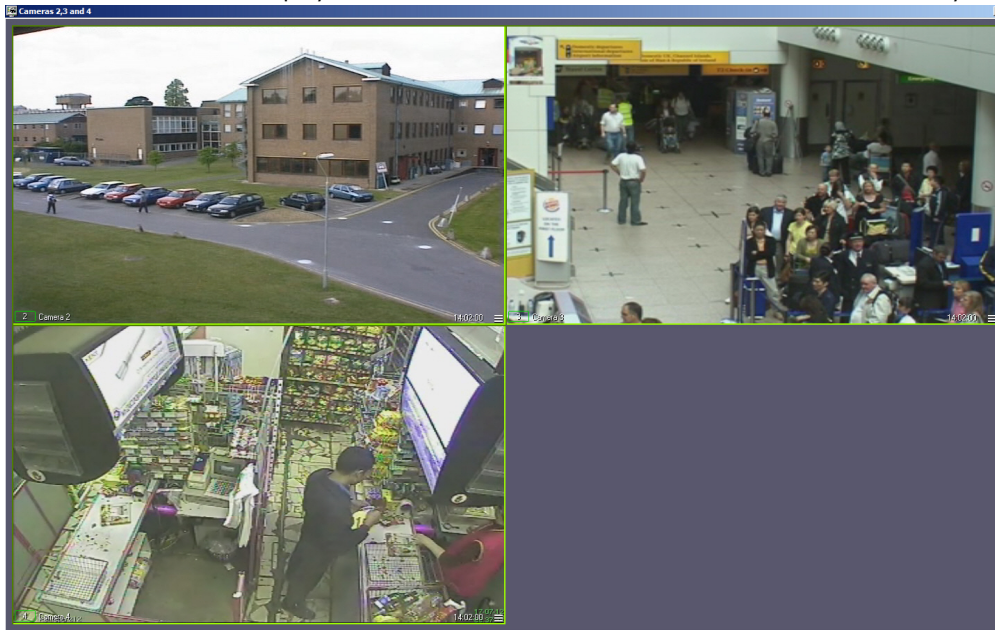



The camera control functions on the layout are the same as those used in the Video surveillance monitor. In particular, it is possible to change the position of the Video surveillance windows on the layout by dragging with the left mouse button. Such changes will be saved after the layout is closed and displayed when it is opened again.

In addition, the function of gradually increasing the Video surveillance window by double clicking with the left mouse button is supported. For more information, see *Altering the number of windows in the Intellect software package. Operator's Guide*. The most current version of this document is available in the [AxxonSoft documentation repository](#).

Example

For example, there is a layout of 9 cameras (3x3). When you double-left-click the upper left camera, its image will not increase to the full screen, but will take the position of the nearest right and lower camera. If you double-left-click again, the image will be expanded to the entire Video Surveillance Monitor window.

Use the  button in the bottom right corner of the viewing tile to enter the archive mode and the  button to exit the archive mode.

Archive playback control functions are the same that those used in the Video monitor in *Intellect*. Find details on these functions in *Intellect software package. Operator's Guide*. The latest version of this document is available in [AxxonSoft documentation repository](#).

Starting external applications from the Control Panel

Rus

You can use the **Menu...** item of the context menu to launch external applications from the Control Panel.

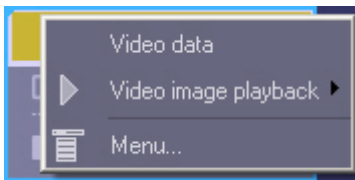

You use the IP address of any object.

For example, if you want to ping any object, follow these steps:

1. Right-click the area that contains the object's name. The context menu opens. Select the **Menu...** menu item. Then the **Menu...** dialog box opens.

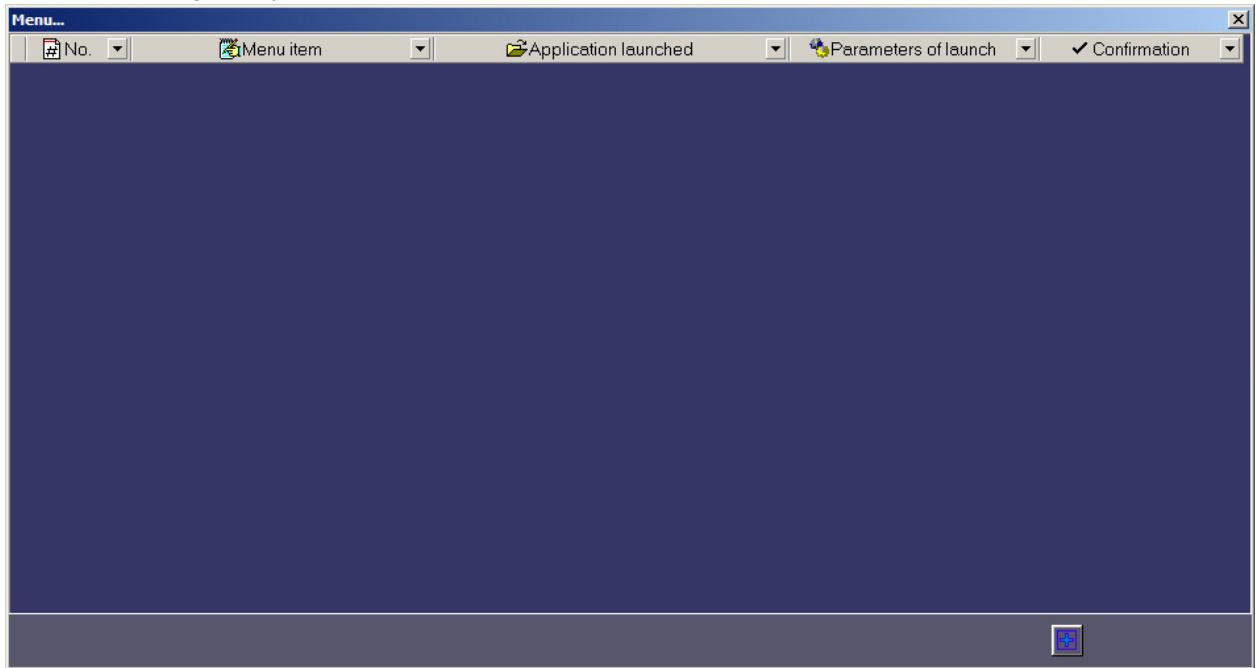

2. In this dialog box, click **Add entry** and enter values as shown in the following figure.

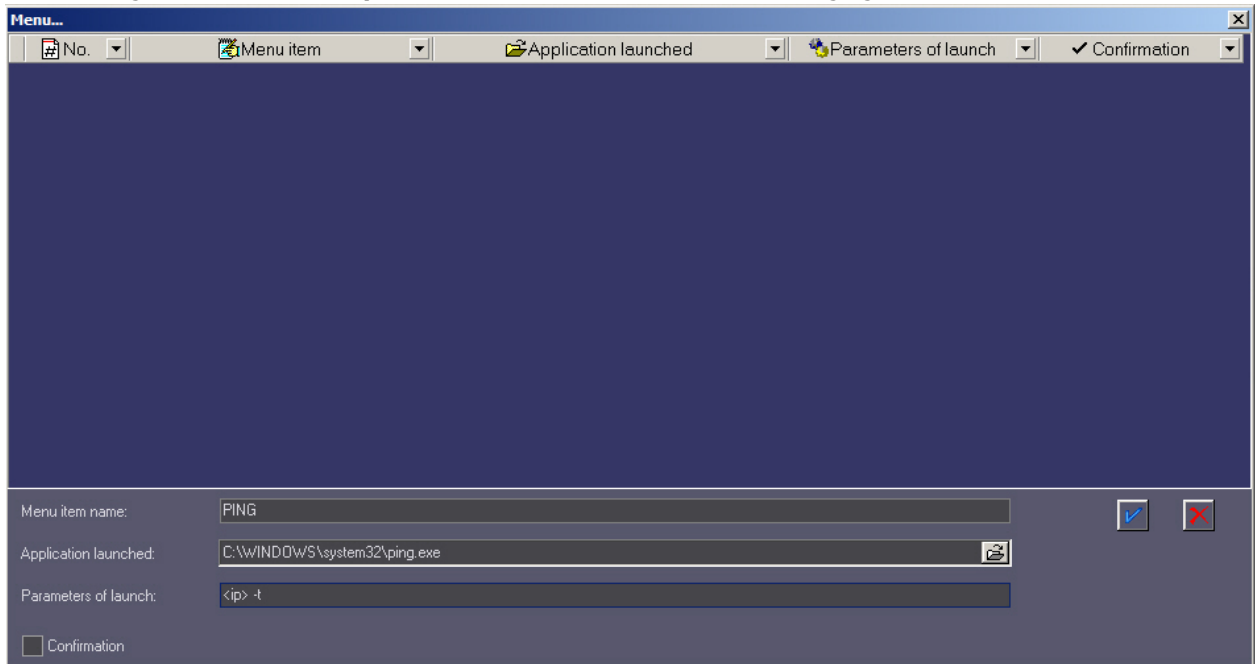

The <ip> string is a reserved expression. When application is called, the real IP address is inserted. Type this string in lowercase.

3. Click **OK**. The **Menu...** window shows a new entry that describes the new context menu item.

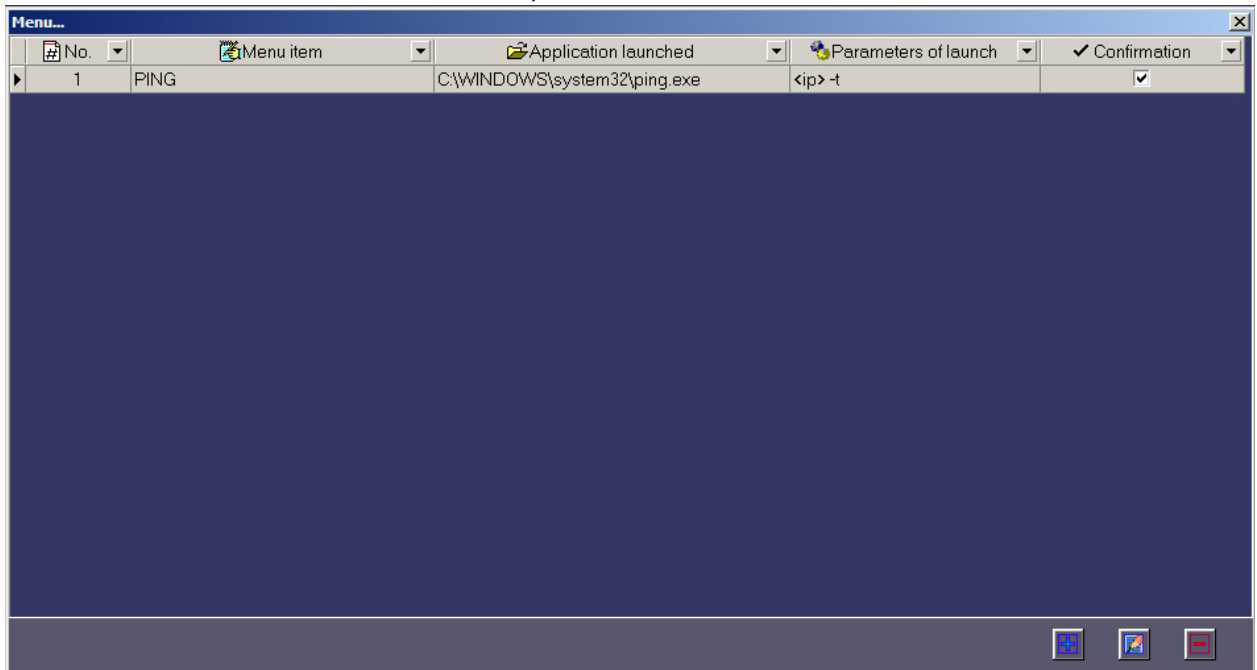

If you right-click on the area that contains an object's name, a context menu opens. The menu contains the new menu item, **PING**.

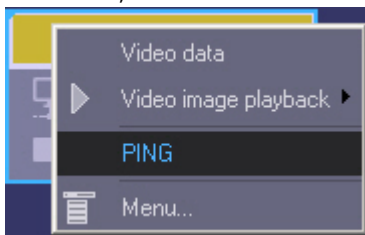

If the **Confirmation** checkbox was set, the dialog box opens to confirm the command execution when you select this menu item. Click **OK** to confirm or **Cancel** if you do not want to execute the action.

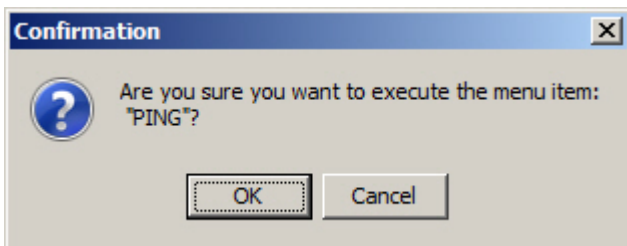

After confirmation, the ping program is started in a separate window.

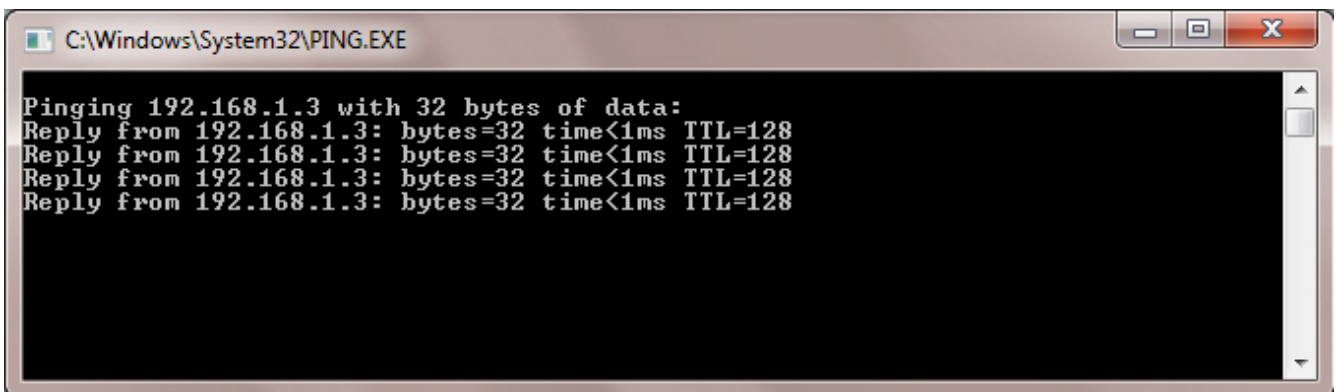

For objects that connect to *Monitoring* via RS232 or objects that never connected to it yet, the 127.0.0.1 value will be used instead of <ip>.

The same way you can create menu items that start other external applications (such as Radmin, etc.).

Executing ad hoc command on the Agent of Control by the operator of Server of Control

Rus

Ad hoc commands can be executed on the *Agent of Control* using the **Menu...** context menu item on the Control Panel.

Important!

Scripts to process incoming commands are to be created on the *Agent of Control*. See [Sample script for processing Server of Control command on Agent of Control](#) section of [Administrator's Guide](#).

Configure command sending on the *Server of Control* as follows:

1. Right-click the area that contains the object's name and select the **Menu...** item in the appeared context menu.

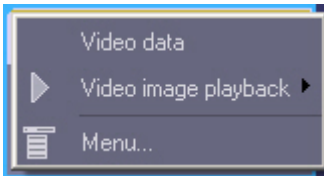

2. The **Menu...** dialog box opens.

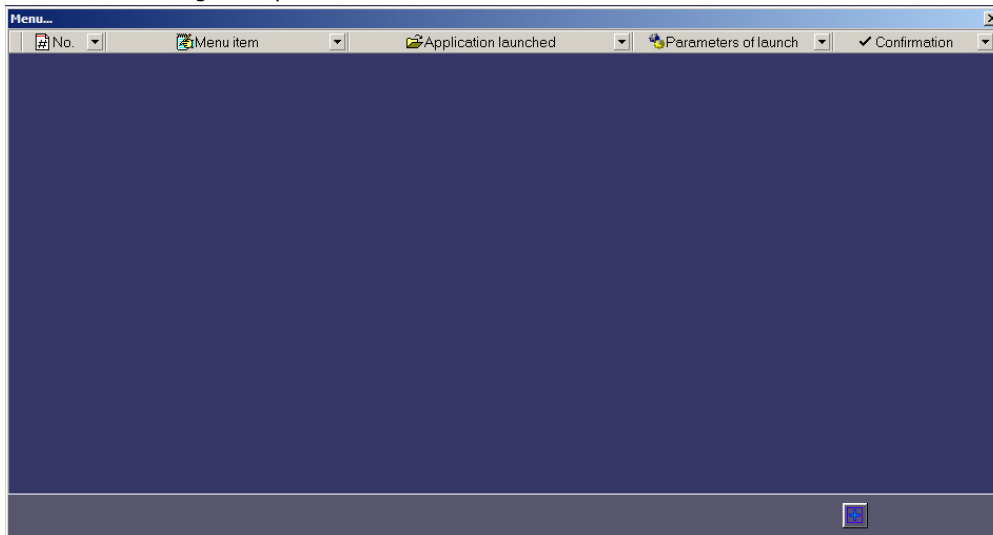

3. Click the  button to add a new menu item. The fields used to configure menu item will be displayed.

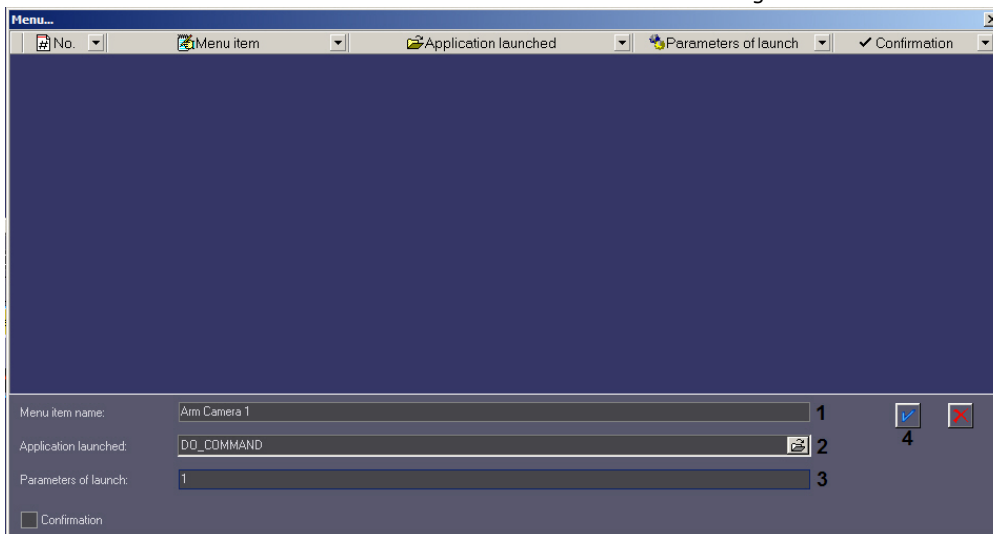

4. In the **Menu item name** field enter the menu item name that will be displayed in the context menu on the Control Panel (1).
5. Enter DO_COMMAND in the **Application being launched** field (2).

6. Enter the value for param0<> parameter in the **Launch parameters** field (3). Using the value of this parameter in the script created on the *Agent of Control* one can find out what command is to be executed.

7. Click the  button (4). The command will be added to the list of commands in the **Menu...** dialog box.

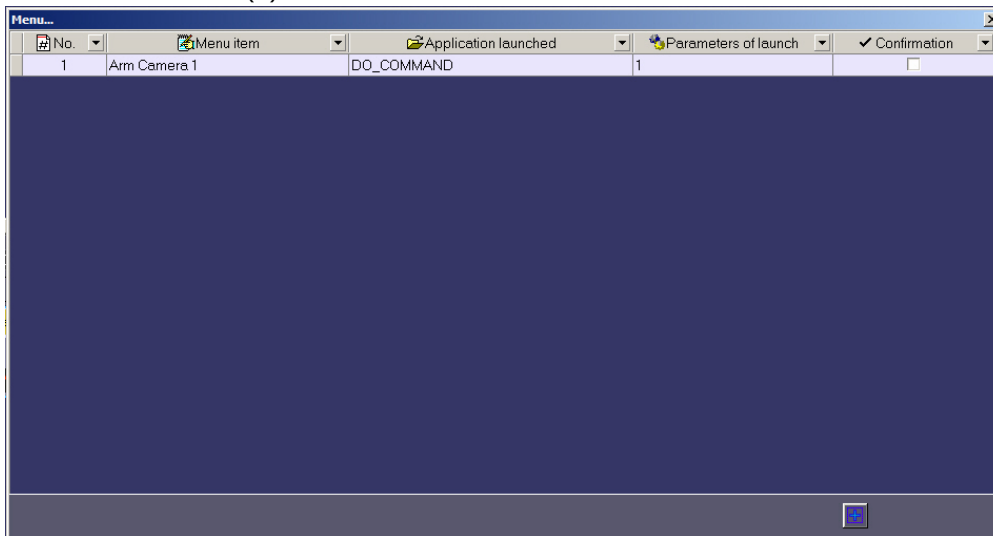

8. Repeat steps 3-7 for all required commands and parameters.

9. Close the **Menu...** dialog box.

The added commands will be displayed in the context menu on the Control Panel.

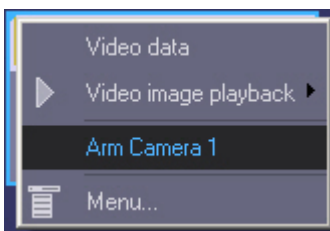

Command sending is now configured on the *Server of Control*.

Log Panel

Log Panel's interface

Rus

The Log Panel has three main parts:

1. Control buttons panel.
2. Working area.
3. Status bar.

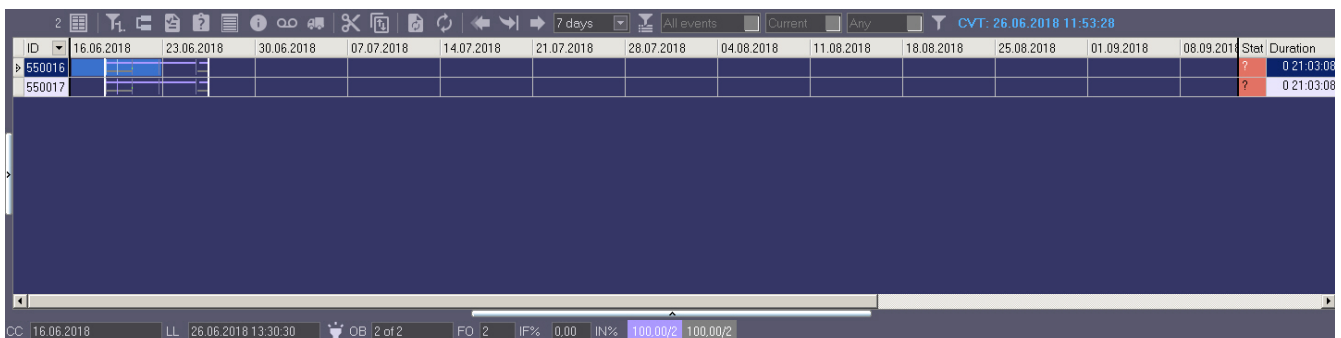

Color definitions for events

In the Log Panel, alarms are shown as color stripes in a table. Each alarm type has its own color. You can learn the meaning of the colors by clicking the button  (**Legend information**). When you click this button, the information window opens .



Vertical stripes mean short-term errors and horizontal stripes mean long-term errors (hardware failure).

Note.

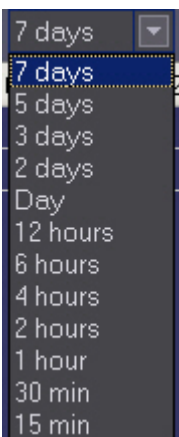

Alarm types are described in the [Alarm types](#) section.

The length of a stripe shows the alarm's duration in accordance with the selected scale. The scale is a time period for one column.



Moving through the list of alarms

Each column's heading always contains the start time for the column's time period. Use the Left and Right keys and the horizontal scrollbar to move to any date within the loaded data.

To quickly move to the required date and time, use the button  (**Go to date**). Use the button  (**Go to end**) if you want to move to the end time of the last download. Use the button  (**Go to the current error begin**) if you want to move to the start of the current error.

The data is loaded to the system at certain times only, so there is a need to refresh the data shown on the screen

automatically. For that, you can use the button  (**Auto refresh**). If this button is in the pressed state, new alarm data is searched in the database. If such data is found, the view is refreshed and you can see the end of the shown data. The date and time of the current view are shown to the right of the filters (Current View Time - CVT).

If the **Auto refresh** button is in the unpressed state, the current view can get outdated. In this case, the date of the last download exceeds the CVT. To show this, a "bulb" flashes in the status bar.

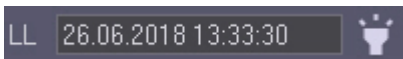

The "bulb" shows that the current view is outdated and that you can refresh it with the button  (**Refresh**). The list is also refreshed when you move to the end, select and apply a filter, and in many other cases.

Ignoring objects

Ignored objects are never shown on the screen. For how to work with ignored objects, see the [Ignoring objects](#) section.

Status bar

On page:

- [General information](#)
- [Functioning and non-functioning rates](#)

General information

The status bar shows the number of non-ignored objects (**OB**) and the number of objects that have hardware failures(**HF**) shown at the moment.



The status bar also shows the start of the displayed period for the current cell column (**CC**), time when the data was last loaded into the database (**LD**), functioning rate (**FR%**) and non-functioning rate (**NR%**) for the video surveillance system, broken down by reason (see the [Functioning and non-functioning rates](#) section).

Important!

The rates are not calculated if the Alarms, Failures or Disconnected filter is enabled – see [Number of alarms displayed](#).

Functioning and non-functioning rates

The status bar shows the functioning rate (**FR%**) and non-functioning rate (**NR%**) for the video surveillance system, broken down by reason.

FR% is calculated according to the following formula:

$(1 - Nnf / Na) * 100$, where

- *Nnf* is the number of objects that do not function properly.
- *Na* is the total number of objects

The non-functioning rate for a particular reason is calculated according to this formula:

$(Nnfbr / Na) * 100$, where

- *Nnfbr* is the number of objects that do not function properly for this particular reason
- *Na* is the total number of objects

These rates are calculated only for non-ignored objects. For ignored objects, these rates are never calculated and the filter is never used. If a non-functioning rate has the value of zero, it is not shown in the status bar.

Number of alarms displayed

Rus

The number of objects shown in the Log Panel or Control panel is defined by the current filter if it is enabled with the filtering button  (**Turn filter on/off**).

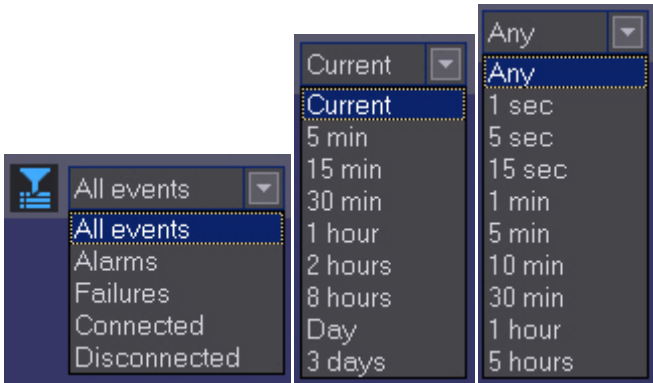

The left list allows to show objects with alarms of failures only, the connected or disconnected objects only. The middle list shows time periods. If there was an alarm during the selected period, it is included on the list. The right list shows the alarm durations that trigger the filter. For example, if you set the filter to "Current - 1 minute", only those objects are shown that are currently in the alarm state and that have already been in this state for 1 minute or more. If you set the filter to "Day- 5 hours", only those objects are shown that have at least once been in the alarm state in the last 24 hours and that were in this state for at least 5 hours.

To calculate rates only for filtered objects, click  (**Calculate rates only for filtered table lines**). If **Alarms**, **Failure** or **Disconnected** filter is enabled, rates are not calculated.

Object status

Rus

The **Status** column shows the objects' status. Its color and contents are explained in the **Definitions** panel (see the [Color definitions for events](#) section). Note that the **Status** column in the Log Panel is shown in red only if there is at least one current long-term alarm.

Alarm duration

Rus

The table's last column (**Duration**) shows the duration of the current alarm for an object in *days hh:mm:ss* format.

Information about an object

Rus

Click  (**Show inspector Ctrl+I**). A special area appears. This area contains short information about the currently selected object. The lower part contains the **Fields** tab.

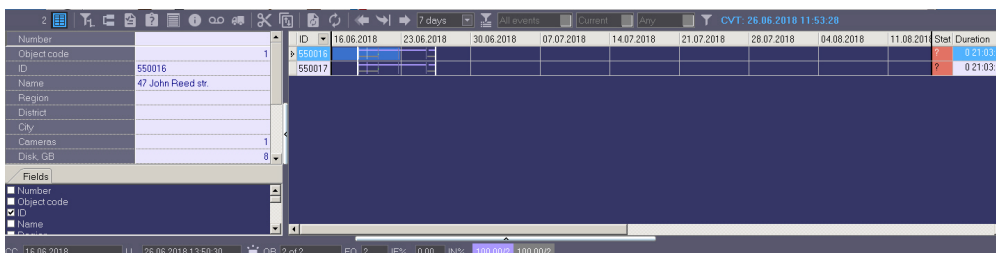

The information is shown (according to the options selected) as columns in the main list of the Log Panel.

ID	Name	Camera:	Disk, GB	Disks	Software
550016	47 John Reed str.	1	8	1	10.0.1375
550017	10 Green spruce dr.	4	8	1	10.0.1375

To get more detailed information about an object, select it in the Log Panel and click  (**Show detailed information**). The **Details** window opens.

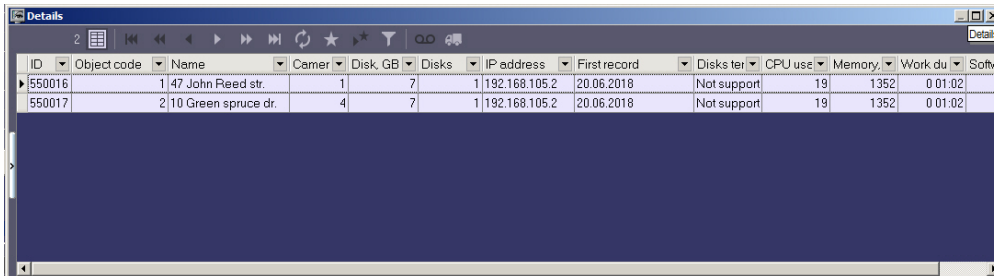

ID	Object code	Name	Camer	Disk, GB	Disks	IP address	First record	Disks ter	CPU use	Memory	Work du	Softw
550016	1	47 John Reed str.	1	7	1	192.168.105.2	20.06.2018	Not support	19	1352	0 01.02	
550017	2	10 Green spruce dr.	4	7	1	192.168.105.2	20.06.2018	Not support	19	1352	0 01.02	

In the **Details** window, click  (**Show inspector Ctrl+I**). A special area appears. The upper part of this area contains information about the currently selected object.

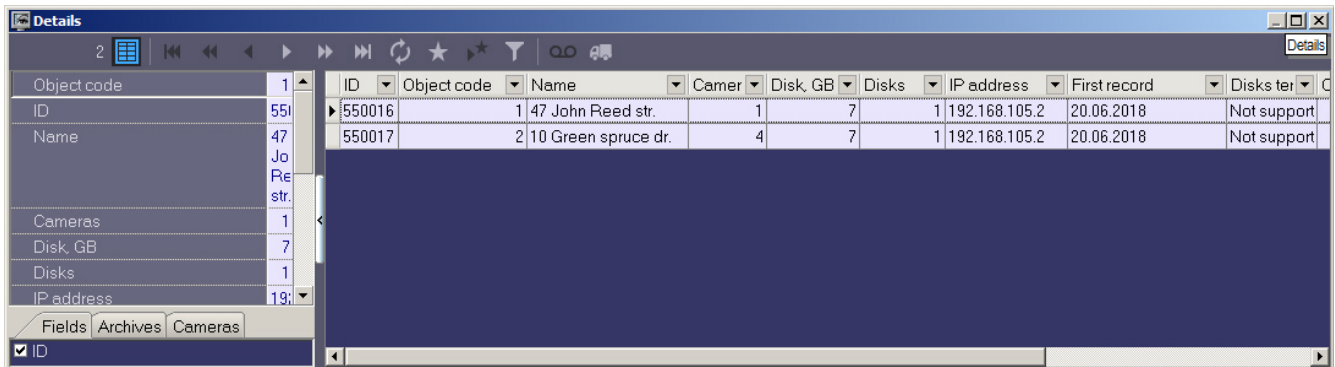

Object code	ID	Name	Cameras	Disk, GB	Disks	IP address
1	550016	47 John Reed str.	1	7	1	192.168.105.2
2	550017	10 Green spruce dr.	4	7	1	192.168.105.2

Note.

If the Owner Panel is in use, then information about only the objects that belong to the owner selected on the Owner Panel is displayed in the **Details** window. To view the details about all system objects, call this window on the Owner Panel – see [Viewing details on alarms for all system objects](#).

The lower part of the area contains three tabs: **Fields**, **Archives**, and **Cameras**. The information is shown (according to the options selected) as columns in the main list of the **Detailed information** window.

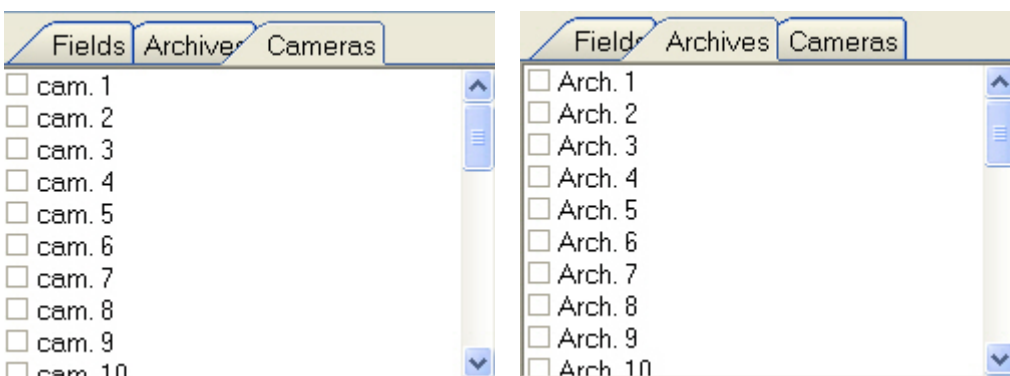

Fields	Archives	Cameras
<input type="checkbox"/> cam. 1	<input type="checkbox"/> Arch. 1	
<input type="checkbox"/> cam. 2	<input type="checkbox"/> Arch. 2	
<input type="checkbox"/> cam. 3	<input type="checkbox"/> Arch. 3	
<input type="checkbox"/> cam. 4	<input type="checkbox"/> Arch. 4	
<input type="checkbox"/> cam. 5	<input type="checkbox"/> Arch. 5	
<input type="checkbox"/> cam. 6	<input type="checkbox"/> Arch. 6	
<input type="checkbox"/> cam. 7	<input type="checkbox"/> Arch. 7	
<input type="checkbox"/> cam. 8	<input type="checkbox"/> Arch. 8	
<input type="checkbox"/> cam. 9	<input type="checkbox"/> Arch. 9	
<input type="checkbox"/> cam. 10	<input type="checkbox"/> Arch. 10	

The data in the **Cameras**, **Disk (GB)**, **Disks**, and **Version** fields and in all the fields in the **Archives** and **Cameras** tabs are filled in automatically when packets with technical information are received from the objects. If these fields are empty for an object, it means that the object never connected yet.

The **Cameras** field shows the number of cameras for the object.

The **Disk (GB)** field shows the maximum free space for all the logical disks where recording is performed.

The **Disks** field shows the number of logical disks where recording is performed.

The **Version** field shows the version of *Control Agent* installed at the object.

The fields in the **Archives** tab show the depth of the video archive in days for each camera.

The fields in the **Cameras** tab show the current status of each camera (**on/off**).

The **IP address** field displays the IP address of the object.

The **First record** field shows the date of the very first entry in the video archive from all cameras.

Field **Disk temp.** shows the temperature of the hard drives separated by a comma if there are several disks.

The **CPU Load,%** field shows the CPU load as a percentage (updated every 15 minutes).

The **Memory, MB** field shows the amount of available physical memory in MB.

The **Work duration** field shows the time of continuous operation of the Intellect.exe\Intellect64.exe process on the object in the format "d hh:mm", where "d" - day "hh" - hours "mm" - minutes.

Note.

The video archive depth is determined by Agent Of Control as follows:

The system calculates the actual number of days when a given camera recorded data to the archive.

Example: The video surveillance system has been working for three days. A camera recorded data on the first and the third days. The camera was turned off on the second day. Thus, for this camera, the archive depth equals two days.



Click the button  (**Show hardware data**). A special area appears. There you can see changes for these values (**Cameras, Disk (GB), Disks, Version** and others).

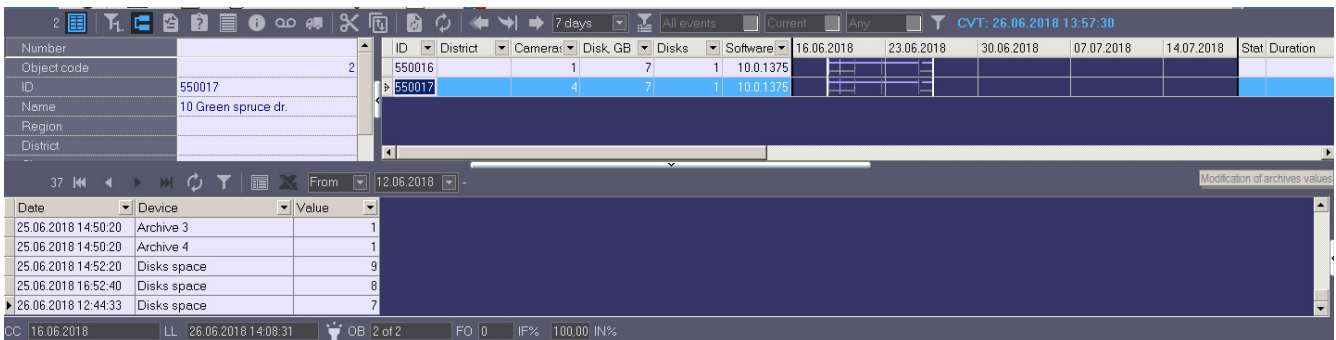

Date	Device	Value
25.06.2018 14:50:20	Archive 3	1
25.06.2018 14:50:20	Archive 4	1
25.06.2018 14:52:20	Disks space	9
25.06.2018 16:52:40	Disks space	8
26.06.2018 12:44:33	Disks space	7

Exceeding the allowed number of failures

Rus

If the number of failures for a displayed object exceeds 500, then alarms for the object have no details and its background gets pink.

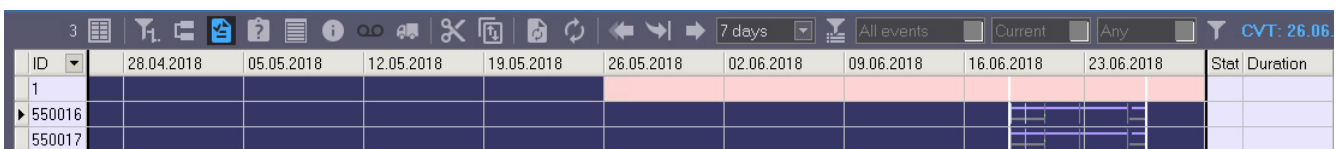



ID	28.04.2018	05.05.2018	12.05.2018	19.05.2018	26.05.2018	02.06.2018	09.06.2018	16.06.2018	23.06.2018	Stat	Duration
1											
550016											
550017											

The number of failures is calculated not for each interval, but for a range of intervals. Consider the case depicted in the figure. Here, the calculation is performed for ten columns from 3:30 p.m. to 6:00 p.m. and for one column from 6:00 p.m. to 6:15 p.m. Even if the maximum number of failures is exceeded in three columns, the background of all ten columns gets pink.

Forcing the confirmation of alarms

Sometimes an alarm must not be considered as an alarm. For example, if the **Set of thermal sensors** parameter was turned on by mistake. In this case, *Monitoring* shows a *Thermal sensors off* alarm that shows that the device is down. Even after the **Set of thermal sensors** parameter is turned off for the object, the alarm is still opened in *Monitoring*.

To fix this inconsistency, click the button  (**Force error closing**). To see the list of errors closed in such a way, click the button  (**Show closed errors**). An additional table in the right part of the screen.

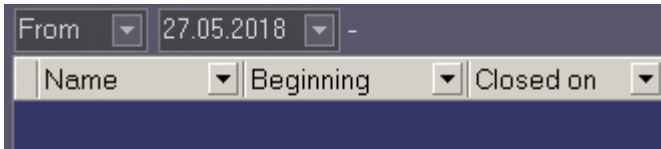

You can double click on an entry in the alarm display area to see the dialog box with an explanation for the errors for the time period of this cell.

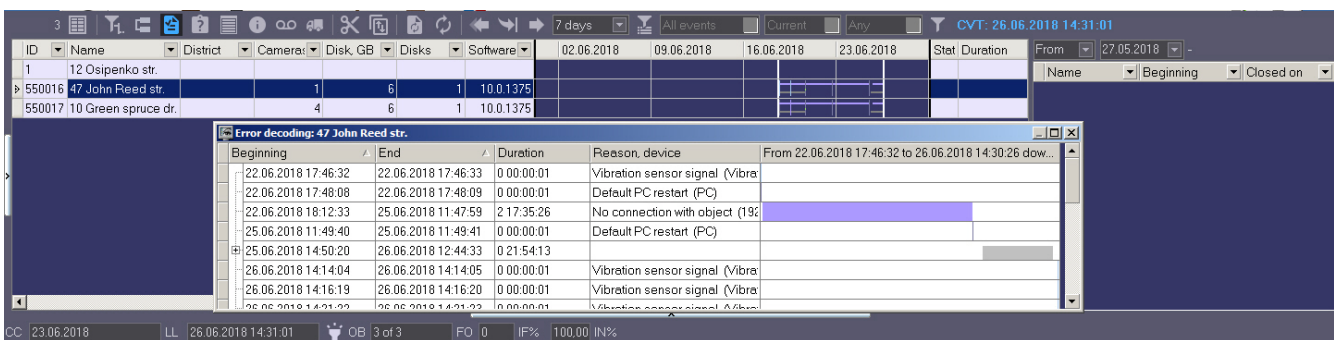

You can double click the area with regulatory and reference information to open the dialog form with a short description of device data.

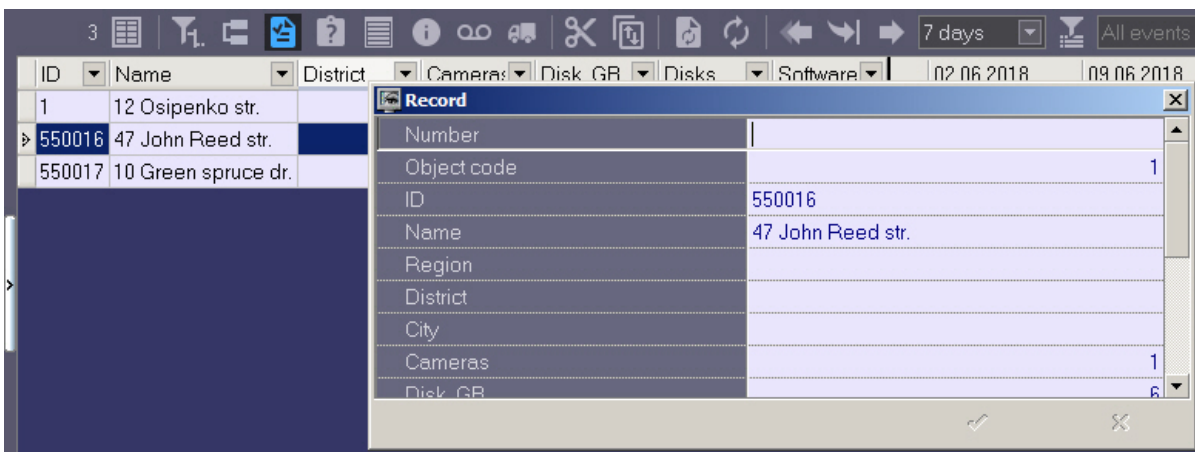

Custom filter in the Log Panel

In addition to the basic filters by the time of registration and the duration of the alarms (see [Number of alarms displayed](#)), it is possible to configure a custom filter to display certain alarms depending on the conditions. This filter is applied to both the Log Panel and the Control Panel.

Click  to set up the custom filter. The **Filter builder** dialog opens.

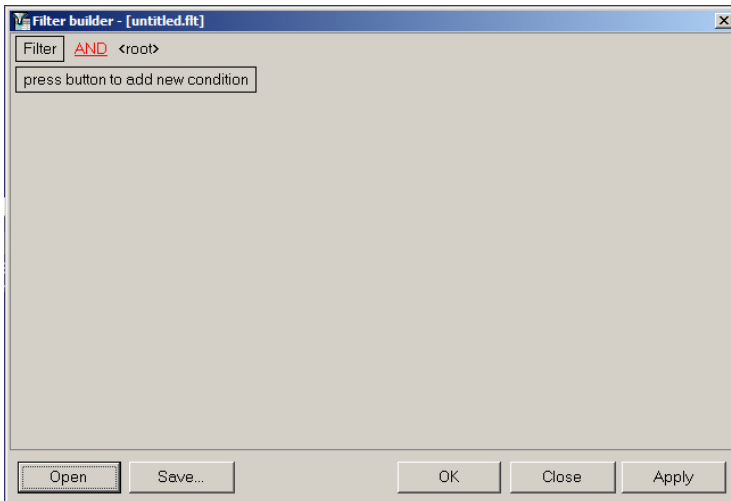

The following operations can be required for setting the filter:

1. Add a condition or subcondition. To add a condition click the **press button to add a new condition** button or in the filter menu click the corresponding item. The condition menu opens by clicking the ... or **Filter**.

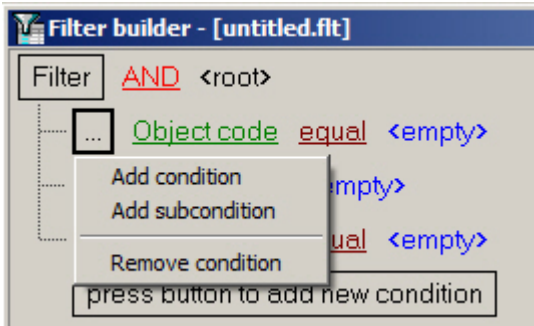

2. Remove a condition. To remove a condition, click the corresponding item in the condition menu.
3. Select a logical function for combining conditions. A drop-down list for selecting the logical function opens on the left-click on the logical function.

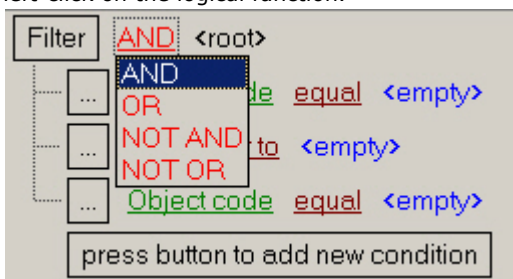

4. Select a field for comparison. A drop-down list for selecting the field for comparison opens on the left-click on the field name.

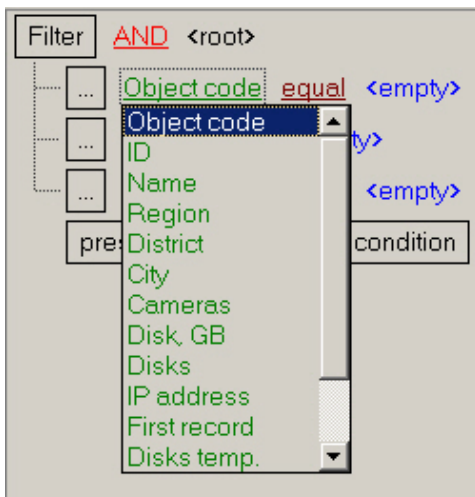

- Select a method of comparing. A drop-down list for selecting the method of comparing opens on the left-click on the method name.

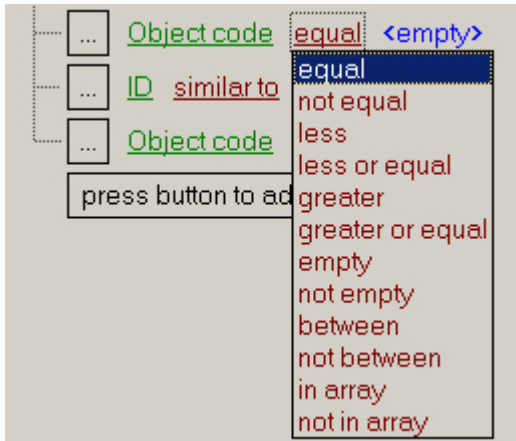

- Select a value for comparing with. A way to select the value depends on the field type. For example, a date can be set using a calendar, a name can be entered in a field, etc.
Data selection:

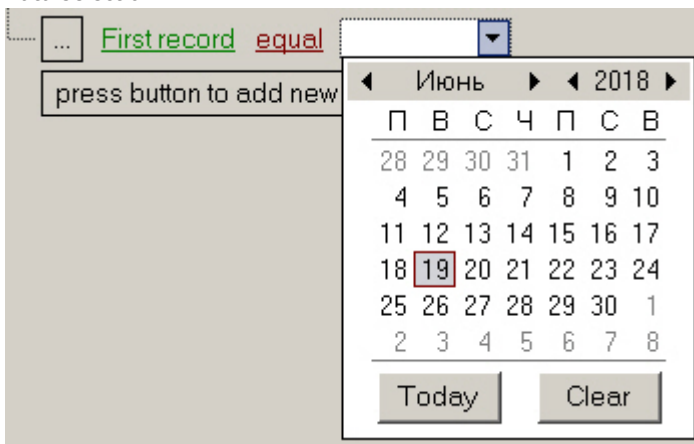

An array of values:



After completing settings, the filter can be saved to a file with the .flt extension by clicking the **Save...** button. This file can then be opened using the **Open** button.

The custom filter on the Log Panel can be set by a script – see [Monitoring Administrator's Guide](#), section [Sample script for setting custom filter in the Log Panel](#).

Owner Panel

Owner Panel interface

Rus

The Owner Panel always operates along with the Control Panel. The Owner Panel interface is shown on the figure.

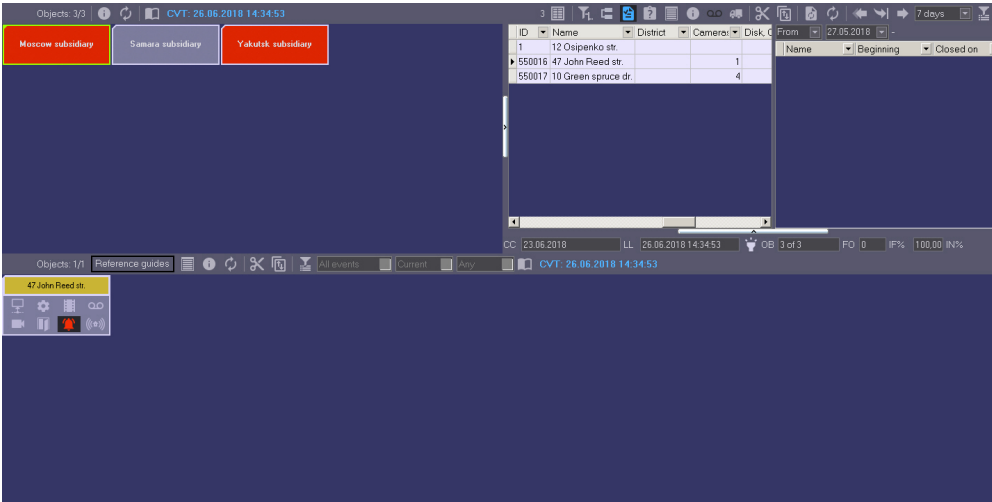

Owners are represented on the panel as rectangles. The color of the rectangle indicates whether there are alarms on the objects that belong to the owner:

1. White (there are no errors on the objects that belong to the owner);
2. Red (on the objects that belong to the owner there are errors and alarms that are not confirmed by the operator);
3. Pink (on the objects that belong to the owner there are errors that are confirmed by the operator).

Left-click the owner, the rectangular is framed blue and only those objects that belong to the owner are shown on the Control Panel.

Information on the Owner Panel is updated after every data loading from the database. Current time of data display on the Owner Panel is shown in the CVT field.

CVT: 26.06.2018 14:34:53

To update display data click the  button. If there are new data in the database, they will be displayed on the Owner Panel.

Objects displayed on the Owner Panel

Rus

According to the user rights set at the stage of system configuration (see [Configuring the Monitoring interface object](#) section of [Administrator's Guide](#)), not all the owners registered in the system can be displayed on the Owner Panel. Information on the displayed and total number of owners is shown in the upper-left of the Owner Panel.

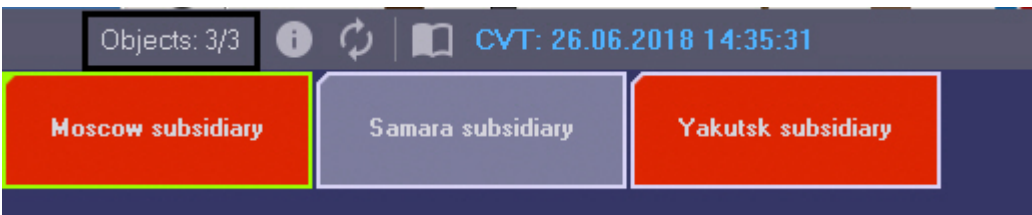

Viewing Event log for all objects

Rus

To view all the events logged in the *Monitoring* software package click the  (**Event log**) button on the Owner Panel. The **Event log** window appears. This table can be sorted by any column or the column can be filtered.

ID	Alarm date	End	Name	Region	District	City	Confirm	Alarm type	Device
550017	26.06.2018 14:25:38	26.06.2018 14:25:39	10 Green spruce dr.				<input type="checkbox"/>	Lock sensor signal	Lock
550017	26.06.2018 14:25:48	26.06.2018 14:25:49	10 Green spruce dr.				<input type="checkbox"/>	Add. sensor signal	Add. sensor
550016	26.06.2018 14:29:05	26.06.2018 14:29:06	47 John Reed str.				<input type="checkbox"/>	Vibration sensor signal	Vibration sensor
550017	26.06.2018 14:29:05	26.06.2018 14:29:06	10 Green spruce dr.				<input type="checkbox"/>	Lock sensor signal	Lock
550017	26.06.2018 14:29:29	26.06.2018 14:29:30	10 Green spruce dr.				<input type="checkbox"/>	Vibration sensor signal	Vibration sensor
550016	26.06.2018 14:29:39	26.06.2018 14:29:40	47 John Reed str.				<input type="checkbox"/>	Vibration sensor signal	Vibration sensor
550017	26.06.2018 14:29:59	26.06.2018 14:30:00	10 Green spruce dr.				<input type="checkbox"/>	Lock sensor signal	Lock
550016	26.06.2018 14:30:01	26.06.2018 14:30:02	47 John Reed str.				<input type="checkbox"/>	Vibration sensor signal	Vibration sensor
550017	26.06.2018 14:30:01	26.06.2018 14:30:02	10 Green spruce dr.				<input type="checkbox"/>	Vibration sensor signal	Vibration sensor
550016	26.06.2018 14:30:25	26.06.2018 14:30:26	47 John Reed str.				<input type="checkbox"/>	Vibration sensor signal	Vibration sensor
550017	26.06.2018 14:30:25	26.06.2018 14:30:26	10 Green spruce dr.				<input type="checkbox"/>	Vibration sensor signal	Vibration sensor
550017	26.06.2018 14:30:49	26.06.2018 14:30:50	10 Green spruce dr.				<input type="checkbox"/>	Overheat sensor signal	Overheat sensor
550017	26.06.2018 14:30:59	26.06.2018 14:31:00	10 Green spruce dr.				<input type="checkbox"/>	Overheat sensor signal	Overheat sensor
550016	26.06.2018 14:32:29	26.06.2018 14:32:30	47 John Reed str.				<input type="checkbox"/>	Vibration sensor signal	Vibration sensor

Note.

To view all the events logged for objects that belong to the selected owner, call the **Event log** window on the Control Panel – see [Event log](#).

Use the **Event log** window in the same way as you use it on the Control Panel – see [Event log](#).

Viewing details on alarms for all system objects

Rus



To view the details about all system objects click the  button on the Owner Panel. The **Details** window appears.

ID	Object code	Name	Camer	Disk, GB	Disks	IP address	First record	Disks ter
550016	1	47 John Reed str.	1	6	1	192.168.105.2	20.06.2018	Not support
550017	2	10 Green spruce dr.	4	6	1	192.168.105.2	20.06.2018	Not support
1	3	12 Osipenko str.						

Note.

To view all the events logged for objects that belong to the selected owner, call the **Details** window on the Control Panel .

Use the **Details** window in the same way as you use it on the Control Panel and Log Panel – see [Information about an object](#).

Alarm message window

Rus

To attract the extra attention to alarm situations use the **Alarm messages window** object.

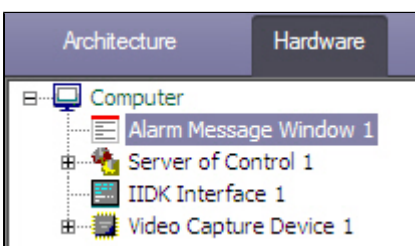

If there is the **Alarm messages window** object in the settings tree of *Intellect* software, the alarm situations will be displayed in the **Control panel** and **Log panel** interface objects and in the separate pop-up window. Examples of such pop-up windows are displayed in figures.

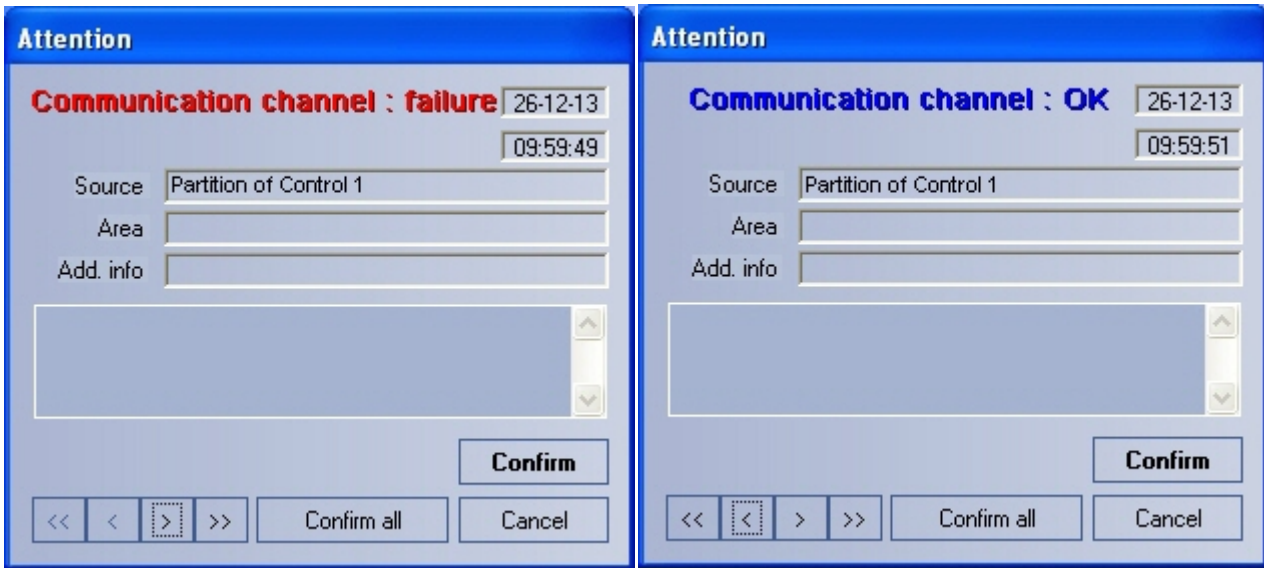

Alarm messages for Communication channel

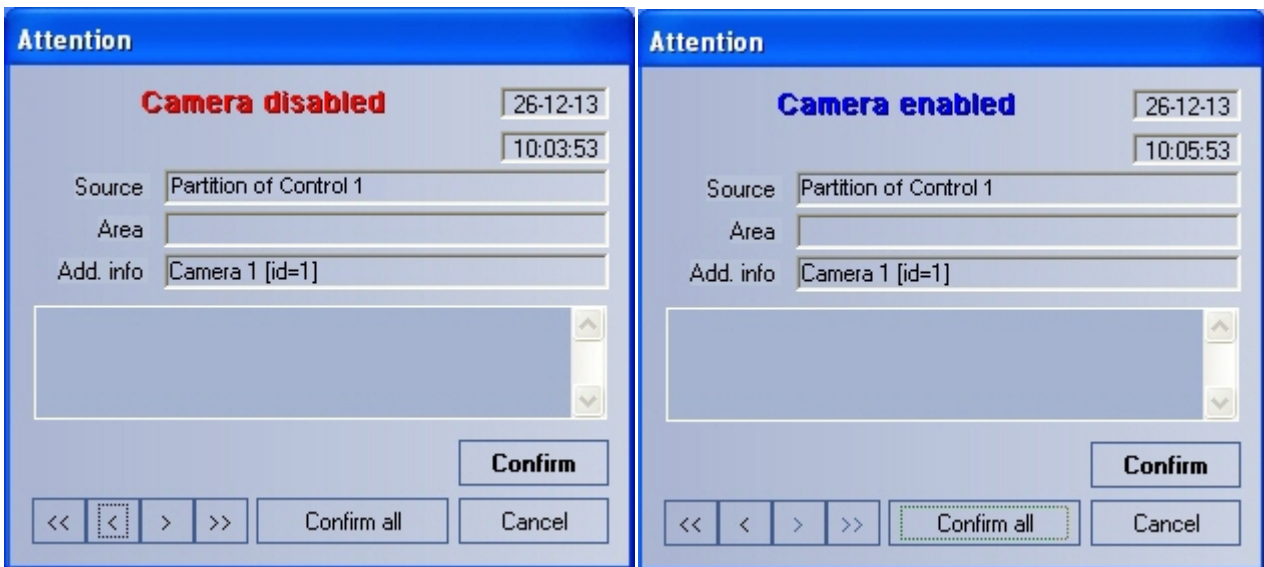

Alarm messages for camera enabling and disabling

Search in archive

Purpose of the Search in archive component

Rus

The **Search in archive** component allows you to do the following:

1. Make and send requests for searching video frames with subtitles and receive video search results.
2. Make and send requests for video frames with or without subtitles and receive video search results.
3. Make and send requests (based on video search results) to an object's video archive, receive and view request results (video frames or video clips).
4. View and prints request results (video frames or video clips).

Request to a video archive by subtitles

To send a request to a video archive by subtitles (**By captions** mode), follow these steps:

1. Open the **Search in archive** component.

2. Select an object from the **Object name** list.
3. Make a request for archive search by using the following parameters:
 1. In the **Period from:** field, set the date and time for the start of the search period.
 2. In the **to:** field, set the date and time for the end of the search period.
 3. Click the **By captions** option button.
 4. Enter any keyword (available only if you click **By captions**).

Note.

If *Agent of control* software is installed with Intellect 4.10.0 or later versions, it is possible to use the * symbol while searching by titles to search for any number of any characters. Example:

card* -> search results will include captions containing words "card", "card-reader" etc.

card -> search results will include only captions containing word "card".

If *Agent of control* software is installed with Intellect 4.9.8 or previous versions, each word is implicitly framed in *. Example:

card -> search results will include captions containing words "card", "card-reader" etc.

4. Set the waiting time by using the **Data timeout (min.)** field.
5. Click **Search**.

Note.

You can cancel the search at any moment by clicking **Cancel**.

6. If the search completes successfully, the search result is displayed as a list of lines. The number of lines in that list is limited to 500.

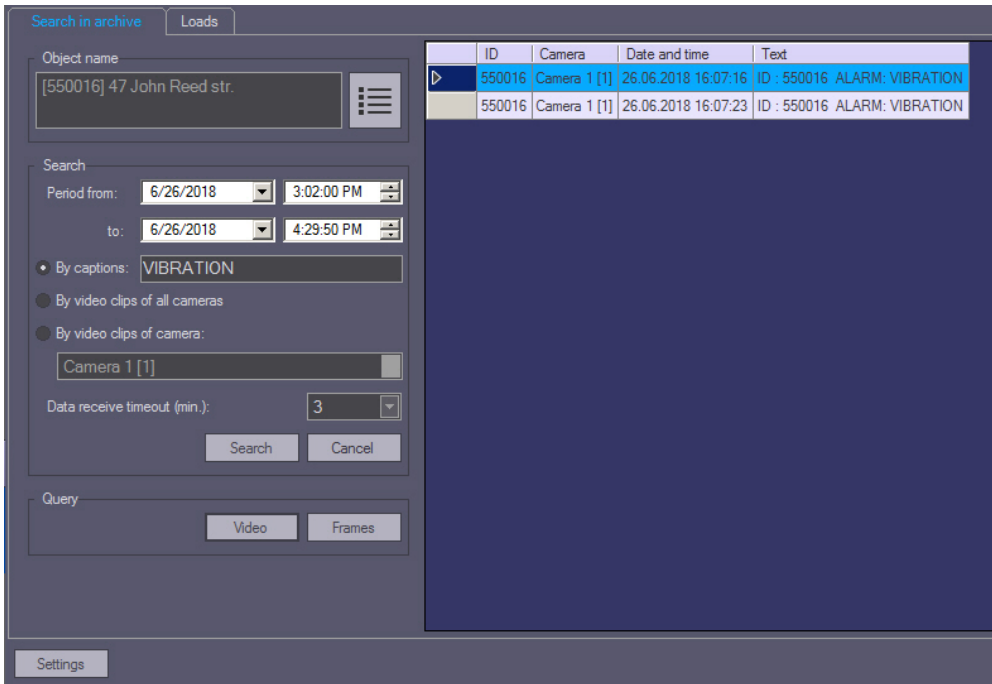

You can also make a request to the archive based on received data (see [Request for video frames from an object](#)).

Attention!

This data is requested from *Intellect's* database at the object. If you want to change how long this data is stored, set the **Events archive length** parameter at the **Security zone** section at the **Programming** tab.

Request to a video archive by video clips

Rus

To send a request to the video archive by clips, follow these steps:

1. Open the **Search in archive** component.

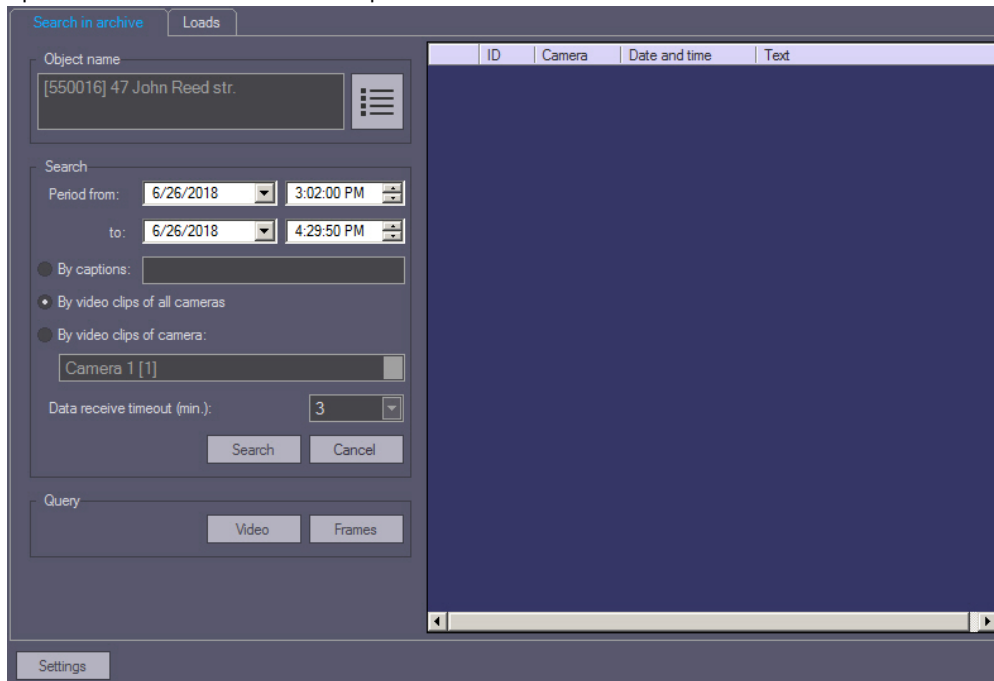

2. Select an object from the **Object name** list.
3. Make a request for archive search by using the following parameters:
 1. In the **Period from:** fields, set the date and time for the start of the search period.

2. In the **to:** fields, set the date and time for the end of the search period.
3. Click the **By video clips on all cameras** option button.

Note.

To search by video clips on a certain camera, click the **By camera clips** option button. Then select the ID of the required camera from the drop-down list.

4. Click **Search**. If the search completes successfully, the search result is displayed as a list of lines. The number of lines in that list is limited to 500.

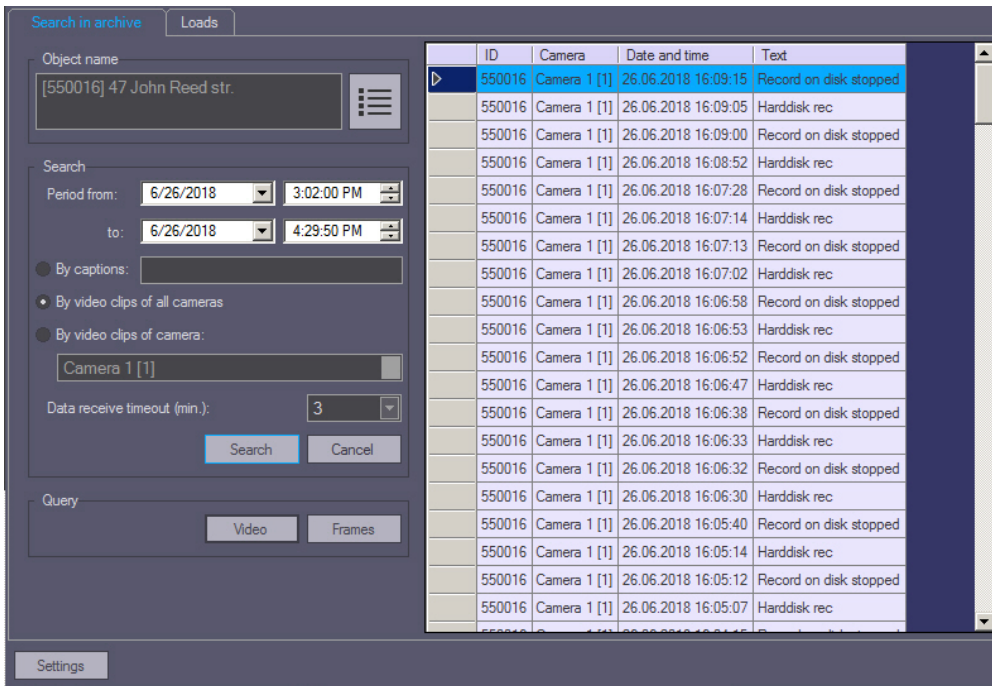

You can also make a request to the archive based on received data (see [Request for video frames from an object](#)).

Attention!

This data is requested from *Intellect's* database at the object. If you want to change how long this data is stored, set the **Events archive length** parameter at the **Security zone** section at the **Programming** tab.

Request for video frames from an object

Rus

You can use received data to request video frames from archives. To do this, follow these steps:

1. Search by titles or clips as described above.
2. The search results are shown as a list of entries. Right click on the required entry. A context menu opens. The menu has two items: **Video query** and **Frame query**.

3. Select the **Frame query** item. The dialog form for the request opens. There is another way to open this form: Select an entry from the list and click **Frames**.

4. The **Date and time** and **Camera** fields are filled in automatically.
5. If you want to make a request with millisecond accuracy, use the **Msec** field.
6. If you select more than one frame, the parameter **Interval between frames** appears. Then enter the interval between frames (with millisecond accuracy).
7. in the **Start** area, select the time for sending the request: click either the **Immediately** option button or **Schedule** option button.
8. Set the waiting time by using the **Data receive timeout, sec.** field.
9. If the check box **Open immediately** is selected, the data is put into the video archive and shown immediately. Otherwise, the data is only sent to the archive. To view such data, use the **Monitoring reports** component.
10. After you fill in all the fields, click **New**.
11. You will get to the **Downloads** tab where the task performance process is displayed. If the data is loaded successfully and the **Open immediately** check box is selected, the loaded frame is shown on the screen.



Note.

In case data have stopped coming during the download, for example if connection with the object is lost, download will be restarted after a random time interval from 1 to 60 seconds. In case of the attempt failure, attempts will be made at intervals of 1 minute.

Information on the time remaining to the restart is displayed in the **Comment** field. Any time you can restart loading manually using the **Restart** button.

ID	Object name	Camera	Date and time of requested video clip	Type	Status	Loaded, %	Requested length, sec	Date and time of planned start	Size, KB	Speed, Kbps	Received KB	View	Comment
550016	47 John Reed str.	Camera 1 [1]	26.06.2018 16:09:05.000	Frames	Ready	100%		26.06.2018 16:10:54	48	0	48		
550016	47 John Reed str.	Camera 1 [1]	20.06.2018 19:51:51.000	Video	Ready	100%	10	22.06.2018 17:48:10	11793	0	11793		
550016	47 John Reed str.	Camera 1 [1]	20.06.2018 19:51:59.000	Video	Ready	100%	10	22.06.2018 17:47:48	8784	0	8784		



Irrespective of the frame size, it is displayed at 352x288 in the opened window. To view the image in the original resolution, click the **Original size** button . To view the image in full screen mode click the **Full screen** button .

If frames are downloaded correctly, it is possible to go to the folder with these frames. For this right-click the corresponding frame and select the **Show in folder** item.

ID	Object name	Camera	Date and time of requested video clip	Type	Status
550016	47	[1]	26.06.2018 16:09:05.000	Frames	Ready
550016	47 John Reed str.	Camera [1]	20.06.2018 19:51:51.000	Video	Ready

Request for video clips from objects

Rus

The **Search in archive** component allows you to request small video clips from an object. For that, follow these steps:

1. Search by titles or clips as described above.
2. The search results are shown as a list of entries. Right click on the required entry. A context menu opens. The menu has two items: **Video request** and **Frame request**.

3. Select the **Video request** menu item. A dialog form for the request opens. There is another way to open this form: Select an entry from the list and click **Video**.

4. The **Date and time** and **Camera** fields are filled in automatically.
5. Use the **Length (sec)** field to limit video clips by time.

Note.

The video fragment is exported at *Agent of Control* using the *Axxon_player.exe* utility, which is part of base *Intellect* installation. This utility does not support the function of frame by frame export. This means that the whole clip or set of clips corresponding to the selected date and time will be exported, depending on the value of the **Length (sec)** parameter. In the context of a single clip, it's impossible to request only part of it.

6. If you want to decrease network load, set the **Bandwidth __ KBps** field to the appropriate value.
7. In the **Start** area, select the time for sending the request: Click either the **Immediately** option button or **Schedule** option button.
8. Set the waiting time by using the **Data receive timeout, sec.** field.
9. If the check box **Open immediately** is selected, the data is put into the video archive and shown immediately. Otherwise, the data is only sent to the archive. To view such data, use the **Monitoring reports** component.
10. If you try to set the value of the **Length (sec)** field to over 120, the value of 120 is offered. This is done to remind the user that such requests can export a big data file from a video archive on *Agent Of Control's* side. If you want to turn this limitation off, click **Settings** in the lower-left area of the **Search in archive** area. A window opens. In the window, change the value of the **Maximum length of loaded video clip, sec** field.

11. After you fill in all the fields, click **New**.
12. You will get to the **Loads** tab where the task performance process is displayed. While the video clip is being downloaded, its file size, loaded size, and transfer rate are shown. You can pause the download at any moment by

clicking **Pause**.

ID	Object name	Camera	Date and time of requested video clip	Type	Status	Loaded, %	Requested length, sec.	Date and time of planned start	Size, KB	Speed, Kbps	Received KB	Xref	Comment
550016	47 John Reed str	Camera 1 [1]	26.06.2018 16:09:05.000	Video	Loading	35%	10	26.06.2018 15:26:40	7311	0	2603		
550016	47 John Reed str	Camera 1 [1]	26.06.2018 16:09:05.000	Frames	Ready	100%		26.06.2018 15:10:54	48	0	48		
550016	47 John Reed str	Camera 1 [1]	20.06.2018 19:51:51.000	Video	Ready	100%	10	22.06.2018 17:48:10	11793	0	11793		
550016	47 John Reed str	Camera 1 [1]	20.06.2018 19:51:59.000	Video	Ready	100%	10	22.06.2018 17:47:48	8784	0	8784		

Note.

In case data have stopped coming during the download, for example if connection with the object is lost, download will be restarted after a random time interval from 1 to 60 seconds. In case of the attempt failure, attempts will be made at intervals of 1 minute.

Information on the time remaining to the restart is displayed in the **Comment** field. Any time you can restart loading manually using the **Restart** button.

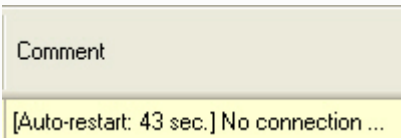

- If the data is loaded successfully and the **Open immediately** check box is selected, the downloaded clip is played with *Axxon Player*.

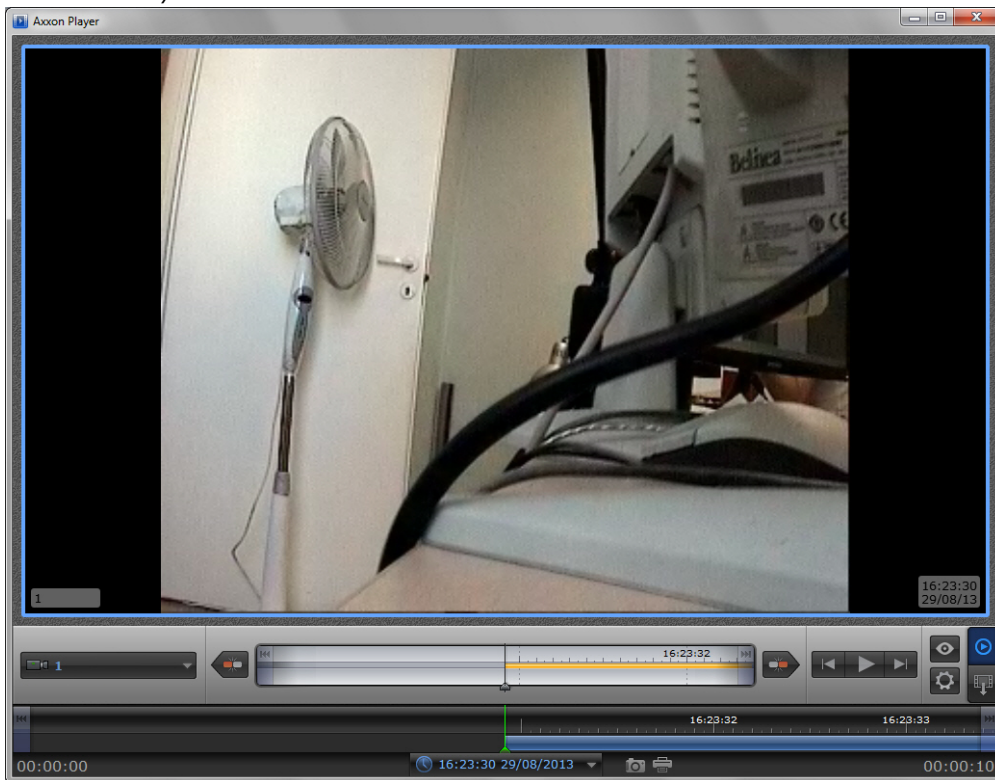

The successfully completed task is marked in green. Double click such entry to see the corresponding frame or play the corresponding video clip. It is also possible to go to the folder with downloaded videos. For this right-click the corresponding frame and select the **Show in folder** item.

ID	Object name	Camera	Date and time of requested video clip	Type	Status	Loaded, %
550016	47 John Reed str	Camera 1 [1]	26.06.2018 16:09:05.000	Video	Ready	100%
550016	47 John Reed str	Camera 1 [1]	26.06.2018 16:09:05.000	Frames	Ready	100%

The **Search in archive** component supports the download resume function. If the connection to **Agent Of Control** breaks during a download, the task status changes to Network Error after two minutes' time-out. The **Comment** field shows the information that the data is no longer being transferred. Ten seconds later the system start periodic attempts to resume

the download. It tries to do it every minute. After the connection to *Agent Of Control* is reestablished, the data is downloaded not from the beginning, but from the point where the connection was lost.

The download resume function uses temporary files. They are saved both on *Agent Of Control* and on *Server Of Control*. These files are stored for three days. After that, they are removed. For example, if you start a download, then click **Pause**, and resume the download five days later, the download starts from the beginning.

To change the storage period for the temporary files, go to the registry and create the value "StoreVideoFiles" in the HKLM\SOFTWARE\BITS\Software\VHOST\VHostService registry branch for 32-bit OS (HKLM\SOFTWARE\Wow6432Node\BITS\Software\VHOST\VHostService for 64-bit) and enter the required data in days. Then restart Videosrv.exe.

If you want to remove old tasks from the task list, go to **Loads** tab and click **Delete** button. Tasks are stored in the database for max. 100 days. If you want to limit the number of tasks that are shown in the **Loads** tab, use the **Task archive size, days** parameter in the **Settings** window opened by **Settings** button in the lower left corner of the **Search in archive** screen (see p. 10).

Attention!

1. If you request a clip that is longer than one minute, you have to increase the value of the **Data receive timeout, sec.** parameter. You must do it, because some time is required for *Agent Of Control* to export large video clip.
2. If *Intellect* closes, all tasks with the "Loading" status are paused. Start these tasks manually to resume download.

Automated video clip loading

Video clip request file

The data source for loading video clips is the .xml text file. The uniqueness of the name of this file is provided by the third party system that forms this file.

The request file includes the following parameters:

Name	Description
ID	Partition of Control object identification number.
DateTimeBegin	Date and time of recording start and search by titles start in the following format: <i>DD-MM-YYYY hh:mm:ss</i>
DateTimeEnd	Date and time of search by titles end in the following format: <i>DD-MM-YYYY hh:mm:ss</i> <i>Note. To be used if the Titles parameter is not set to 0</i>
Length	The length of the requested video clip. Possible values: 1 - 9999
DateTimeExecute	Date and time to execute the request of the video clip in the following format: <i>DD-MM-YYYY hh:mm:ss</i> <i>Note. If 0 is set for this parameter, the request is executed immediately.</i>
Cam	Camera sequence number from top to bottom. The need to use the camera sequence number rather than the internal number is due to the fact that the internal camera number is not transmitted from older system versions. Example. There are 3 cameras on the <i>Agent of Control</i> : <ol style="list-style-type: none"> 1. Number = "1". Name = "Camera 1. Door" 2. Number = "3". Name = "Window" 3. Number = "5". Name = "Arch" The cameras are added to the Partition of Control in the following order:

	<ol style="list-style-type: none"> 1. "Camera 1. Door" 2. "Arch" 3. "Window" <p>Cameras are displayed on Server of Control in the corresponding order. Thus, to get a video from the camera "Arch", the parameter Cam should be equal to 2.</p> <p><i>Note. If you specify 0, the video clips are downloaded from all object video cameras added while setting the Agent of Control.</i></p>
Titles	<p>A string to search by titles. The string should not be longer than 40 characters.</p> <p>If Agent of Control is installed with Intellect version 4.10.0 or higher, use * to search for any number of characters, for example:</p> <ul style="list-style-type: none"> • <i>sala*</i> - the search by this strings returns all titles with words beginning with "sala", e.g. "salad", "salamander". • <i>salad</i> - the search by this strings returns the titles with the word "salad" only. • <i>sala</i> - the search by this strings returns no titles unless they include exact match. <p>If the <i>Agent of Control</i> is installed with Intellect version 4.9.8 and below, all words beginning with the search string will be found, for example:</p> <ul style="list-style-type: none"> • <i>sala</i> - the search by this strings returns all titles with words beginning with "sala", i.e. both "salad" and "salamander". <p><i>Note 1. If you specify a value of 0, no titles will be searched. Also, in this case, the parameters OnlyWithTitles and DateTimeEnd are shall not be used.</i></p> <p><i>Note 2. If you specify an empty string, the search will be performed by any titles.</i></p> <p><i>Note 3. To use the characters in the search string as characters only, not as markup, use the CDATA section.</i></p>
OnlyWithTitles	<p>Download video clip if titles found only. Possible values:</p> <p>0 — video clip is downloaded</p> <p>1 — video clip is not downloaded</p>
DownloadSpeed	<p>Download speed of the video in KB / sec. Possible values: 0 - 1000</p> <p><i>Note. If you specify a value of 0, then the download speed is not limited.</i></p>

See the example of the file on the picture below.

```
<?xml version="1.0" encoding="utf-8" ?>
<Settings>
  <ID>550016</ID>
  <DateTimeBegin>28-03-2017 12:00:00</DateTimeBegin>
  <DateTimeEnd>28-03-2017 19:00:00</DateTimeEnd>
  <Length>10</Length>
  <DateTimeExecute>0</DateTimeExecute>
  <Cam>1</Cam>
  <Titles><![CDATA[Vibro*]]></Titles>
  <OnlyWithTitles>1</OnlyWithTitles>
  <DownloadSpeed>0</DownloadSpeed>
</Settings>
```

Operating principle of automated video clip loading

Note.

See [Video clip request file](#) for description of request file. See note in [Configuring automated video clip loading](#) for description of folders.

The *Search in archive* module scans the **In** directory for the request files every 10 seconds. When the request file appears, the task is set up to load the video clip according to the contents of this file. At this point, the request file is moved to the **In\Work** directory. If the Titles parameter is set to a value other than 0, the query for finding titles in the specified time period from **DateTimeBegin** to **DateTimeEnd** is pre-executed. If the search finishes successfully, a request is generated to load the video, in which the date and time of the first record in the title search results is specified as the date and time of the beginning of the export from the archive.

If the request file could not be read or the request file parameters are incorrect, then the it is moved to the **OutError** directory. If the request was correctly generated, but the video was not downloaded for any reason, then the request file is transferred to the **OutFail** directory. If the video clip is successfully downloaded, the request file is moved to the **OutSuccess** directory.

During the creation of the task, the **query_M.log** text log file is created in the **In** directory for the request files, where **M** is the current month. This log file stores information about all the movement of request files and errors during their execution.

On the *Downloads* tab in the interface of the *Search in archive* module, there is an **Xml** column. If the download task was generated based on the request file, this field will indicate the name of the file.

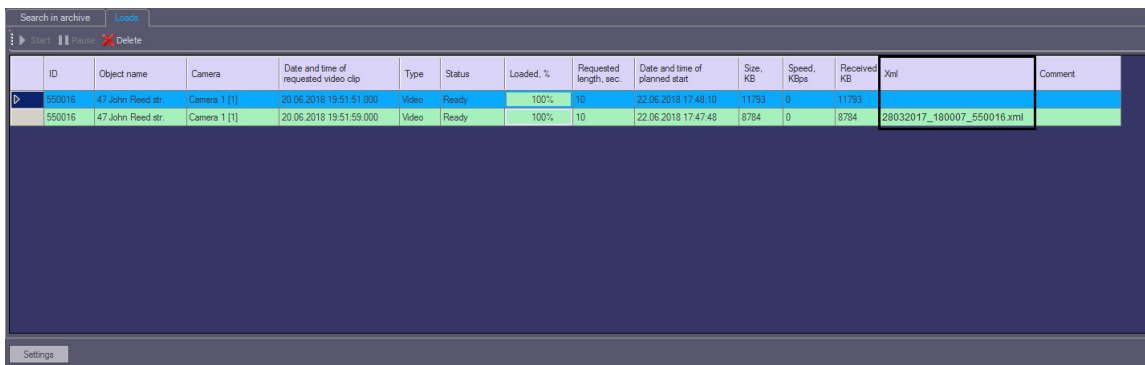

ID	Object name	Camera	Date and time of requested video clip	Type	Status	Loaded, %	Requested length, sec.	Date and time of planned start	Size, KB	Speed, KBps	Received, KB	Xml	Comment
550016	47 John Reed str	Camera 1 [1]	20.06.2018 19:51:51.000	Video	Ready	100%	10	22.06.2018 17:48:10	11793	0	11793		
550016	47 John Reed str	Camera 1 [1]	20.06.2018 19:51:59.000	Video	Ready	100%	10	22.06.2018 17:47:48	8784	0	8784	28032017_180007_550016.xml	

Monitoring Reports

Purpose of Monitoring Reports

Rus

Use the **Monitoring reports** component to automate the processing of statistical information on system performance. You can create reports of the following types:

1. Hardware failures report.
2. Alarms report.
3. Video report.
4. Statistical report.
5. Statistical report by owners.
6. Vehicle LPs report.

Some reports can be hidden while configuring the system – see [Configuration of the Monitoring Reports object](#).

General view of **Monitoring reports** window is shown in figure.

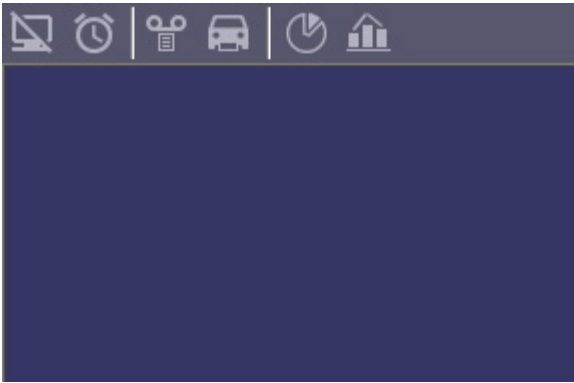

Note.

Format of date and time present in reports depends on system regional and language options.

Hardware failures reports

Rus

To start creating a report, click **System failures**.



A modal window opens. In this window, you can set the parameters needed to create the report.

System failures	
Object description	all objects
Region	all objects
District	all objects
City	all objects
Failure type	all failures
Beginning date	6/26/2018
Beginning time	12:00:00 AM
End date	6/26/2018
End time	03:42:08 PM
Sorting	event

You can set the following report parameters:

1. The time range of the report. Use the **Beginning date**, **Beginning time**, **End date**, and **End time** fields.
2. **Object description**. You can use this field to choose between two report modes:
 1. Report on all the system objects.

2. Report on one system object.



3. **Failure type** You can use this field to specify the failure type for which to create the report. You can also create a report on all the failures within a certain time period.

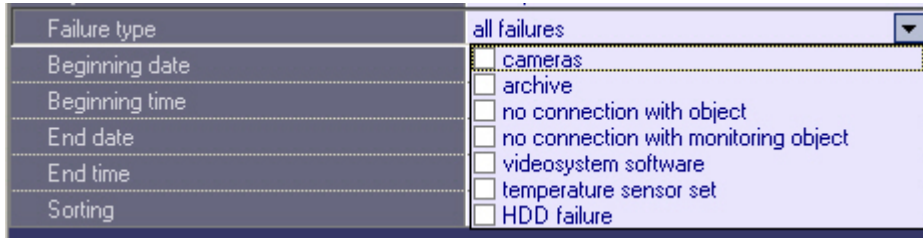

4. **Sorting.** You can use two sorting modes when creating a report:

1. Sort by events (**Cameras, Archive**, etc.).
2. Sort by event start time.



After you configure all the parameters, click **OK**. You can see the report in a separate window.

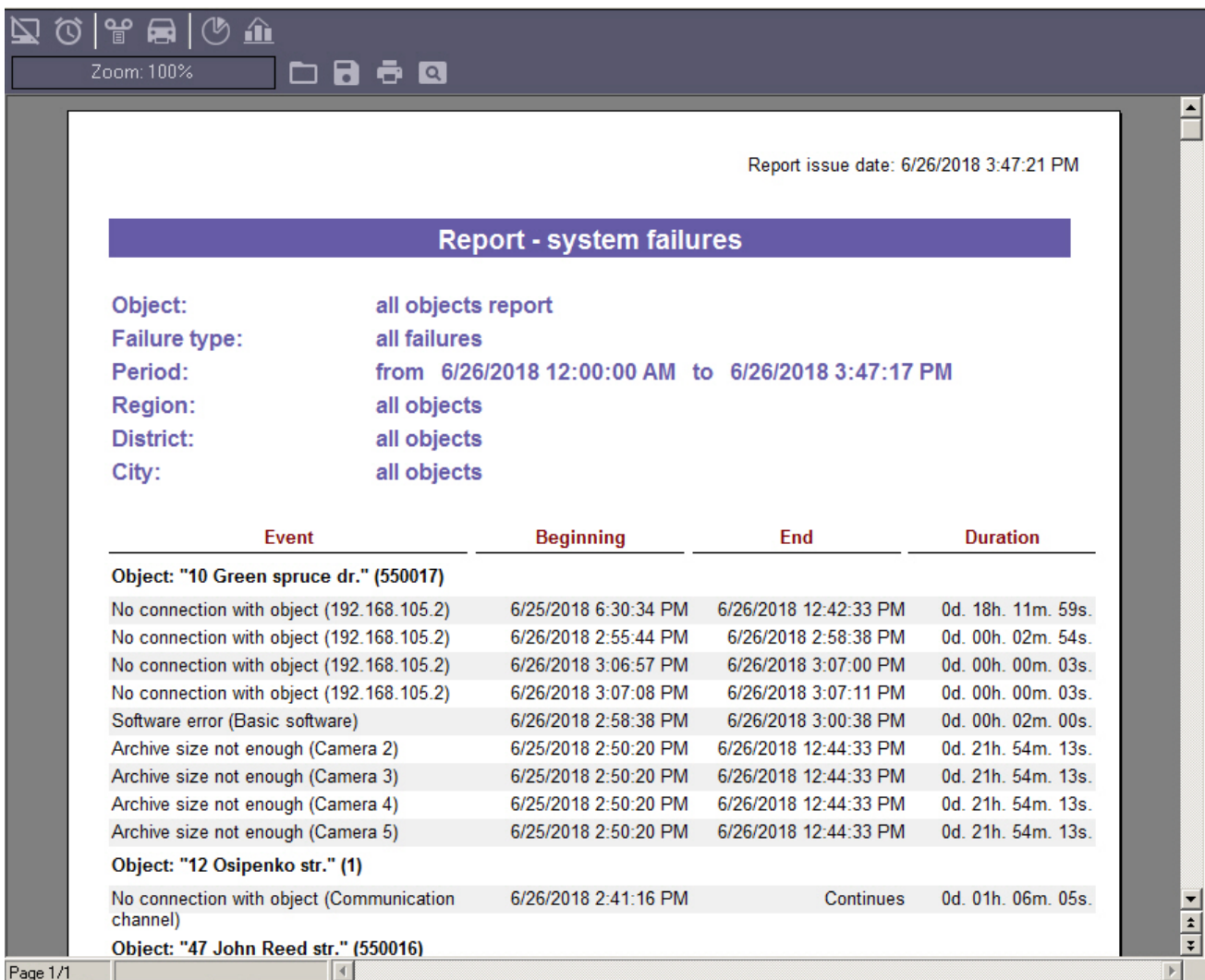

The same report for one object looks as shown in the figure.

Zoom: 100%

Report issue date: 6/26/2018 3:53:02 PM

Report - system failures

Object: 10 Green spruce dr.
Failure type: all failures
Period: from 6/26/2018 12:00:00 AM to 6/26/2018 3:47:17 PM
Region:
District:
City:

Event	Beginning	End	Duration
Object: "10 Green spruce dr." (550017)			
No connection with object (192.168.105.2)	6/25/2018 6:30:34 PM	6/26/2018 12:42:33 PM	0d. 18h. 11m. 59s.
No connection with object (192.168.105.2)	6/26/2018 2:55:44 PM	6/26/2018 2:58:38 PM	0d. 00h. 02m. 54s.
No connection with object (192.168.105.2)	6/26/2018 3:06:57 PM	6/26/2018 3:07:00 PM	0d. 00h. 00m. 03s.
No connection with object (192.168.105.2)	6/26/2018 3:07:08 PM	6/26/2018 3:07:11 PM	0d. 00h. 00m. 03s.
Software error (Basic software)	6/26/2018 2:58:38 PM	6/26/2018 3:00:38 PM	0d. 00h. 02m. 00s.
Archive size not enough (Camera 2)	6/25/2018 2:50:20 PM	6/26/2018 12:44:33 PM	0d. 21h. 54m. 13s.
Archive size not enough (Camera 3)	6/25/2018 2:50:20 PM	6/26/2018 12:44:33 PM	0d. 21h. 54m. 13s.
Archive size not enough (Camera 4)	6/25/2018 2:50:20 PM	6/26/2018 12:44:33 PM	0d. 21h. 54m. 13s.
Archive size not enough (Camera 5)	6/25/2018 2:50:20 PM	6/26/2018 12:44:33 PM	0d. 21h. 54m. 13s.

Page 1/1

Each report window contains a tool bar.

Zoom: 100%

1 2 3 4 5

No.	Description
1	Scale
2	Open report
3	Save report
4	Print
5	Search for text in report

Here are some details on the **Save report** and **Open report** buttons. For example, if there is no printer at the place where the **Monitoring Reports** component is installed or if you want to save your report in electronic form to view it later, you can save the report as a FRP, XLS, XML, RTF, or HTML file. Then you can open the report on another computer.

Alarms reports

Rus

To start creating a report, click **Alarms**.



A modal window opens. In this window, you can set the parameters needed to create the report.

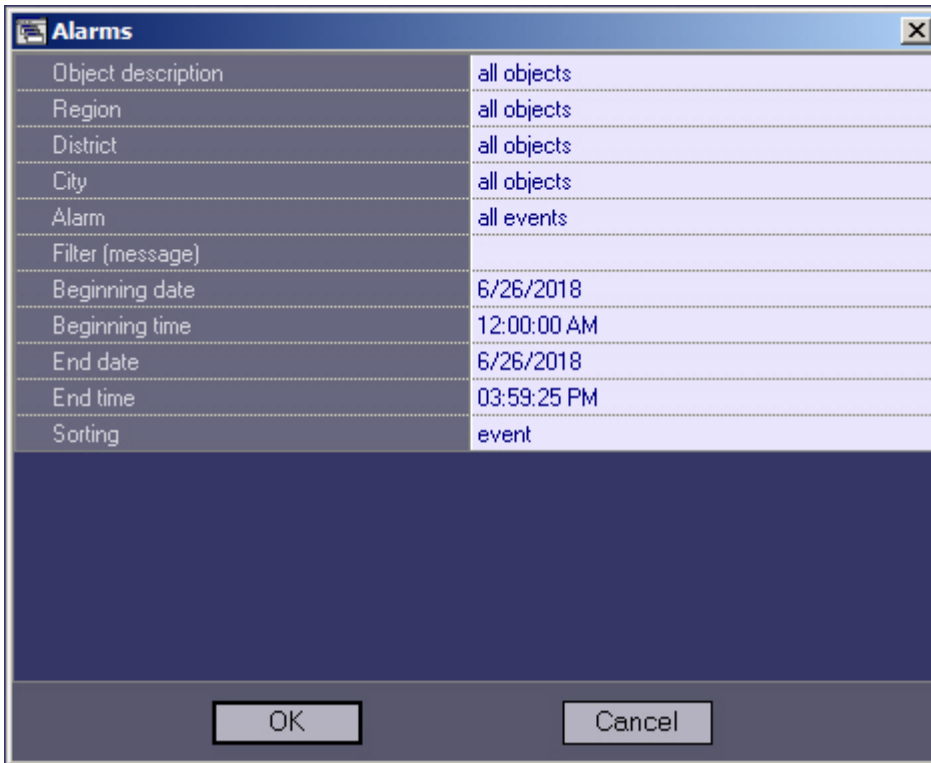

You can set the following report parameters:

1. The time range of the report. Use the **Beginning date**, **Beginning time**, **End date**, and **End time** fields.
2. **Object description**. You can use this field to choose between two report modes:
 1. Report on all the system objects.
 2. Report on one system object.

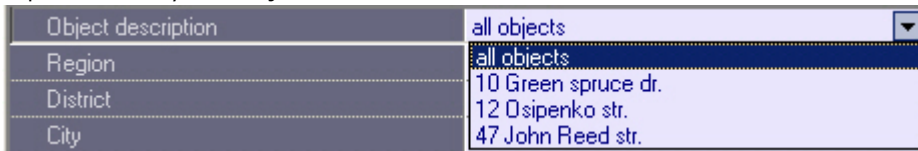

3. **Alarm**. You can use this field to specify a certain alarm for creating the report. You can also create a report on all the alarms within a certain time period.

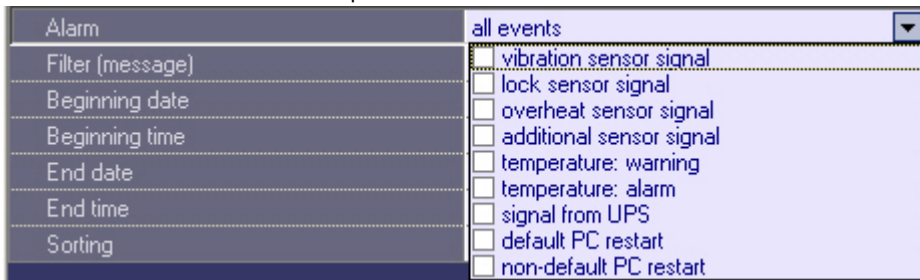

4. **Sorting**. You can use two sorting modes when creating a report:
 1. Sort by events (**Vibration sensor signal**, **Lock sensor signal**, etc.).
 2. Sort by event start time.



After you configure all the parameters, click **OK**. You can see the report in a separate window.

Report issue date: 6/26/2018 4:00:39 PM

Report - alarms

Object: all objects report
Alarm: all events
Period: from 6/26/2018 12:00:00 AM to 6/26/2018 3:59:25 PM
Region: all objects
District: all objects
City: all objects

Event	Time
Object: "10 Green spruce dr." (550017)	
Vibration sensor signal	6/26/2018 2:14:07 PM
Vibration sensor signal	6/26/2018 2:14:37 PM
Vibration sensor signal	6/26/2018 2:14:59 PM
Vibration sensor signal	6/26/2018 2:15:24 PM
Vibration sensor signal	6/26/2018 2:15:44 PM
Vibration sensor signal	6/26/2018 2:16:22 PM
Vibration sensor signal	6/26/2018 2:17:01 PM
Vibration sensor signal	6/26/2018 2:17:27 PM
Vibration sensor signal	6/26/2018 2:17:32 PM
Vibration sensor signal	6/26/2018 2:18:25 PM
Vibration sensor signal	6/26/2018 2:19:28 PM
Vibration sensor signal	6/26/2018 2:19:55 PM

Page 1/4

Video report

Rus

To start creating a report, click **Video report**.



A window opens. In this window, you can set the parameters needed to create the report.

Video report [X]

Object description	all objects
Report type	snapshots - operations
Beginning date	6/26/2018
Beginning time	12:00:00 AM
End date	6/26/2018
End time	11:59:59 PM
Camera	all cameras
Card number	
Operation sum	

OK
Cancel

You can set the following report parameters:

- The time range of the report. Use the **Beginning date**, **Beginning time**, **End date**, and **End time** fields.
- Object description**. You can use this field to choose between two report modes:
 - Report on all the system objects.
 - Report on one system object.

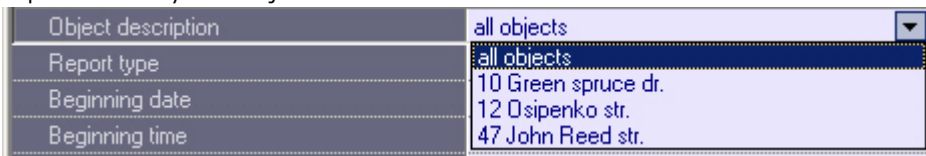

- Report type**. You can use this field to select one of the four report types:
 - Video frames – Alarms**. These are video frames received after an alarm sensor goes off at the object (**Vibration sensor signal**, **Lock sensor signal**, etc.).
 - Video frames – Others**. These are video frames received during an arbitrary request to the video archive.
 - Snapshots – Alarms**. These are video clips received after an alarm sensor goes off at the object.
 - Snapshots – Others**. These are video clips received during an arbitrary request to the video archive.

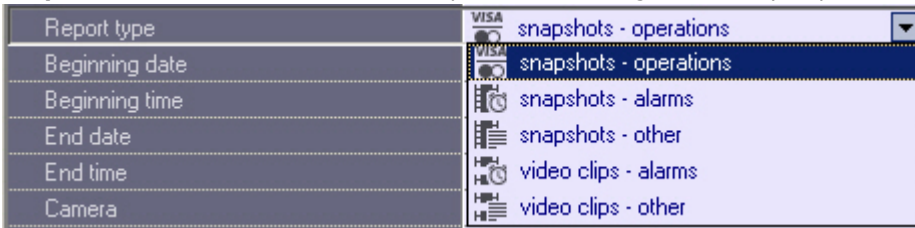

- If you select **Video frames – Others**, you can edit the **Camera ID** parameter. Use this parameter to specify the ID of a camera from which you want to get video frames.

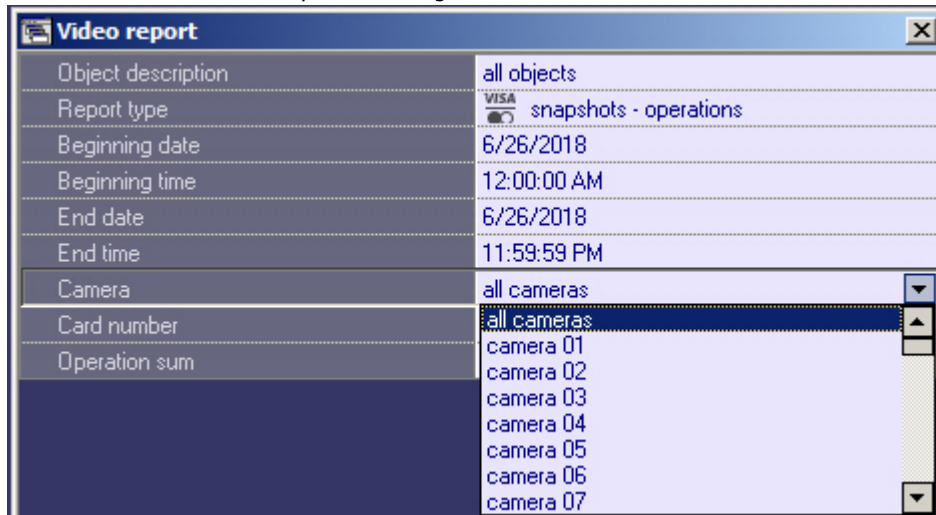

After you configure all the parameters, click **OK**. You can see the results of the search by the specified criteria in the separate window.

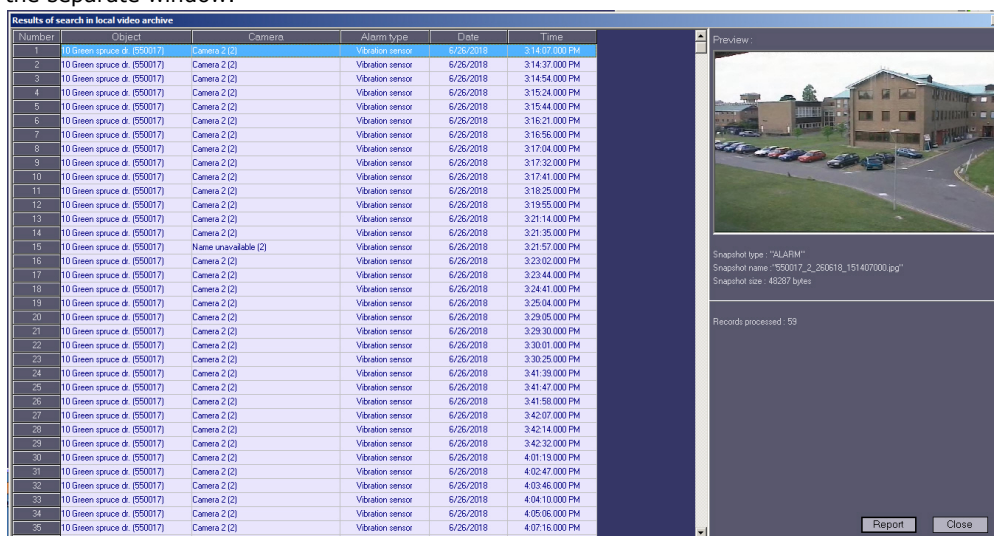

After you select a frame, click **Report**. The report window opens.

Zoom: 100%

Report

Video report - alarms



Object: 10 Green spruce dr. (550017)
Date-time on site: 6/26/2018 3:17:41.000 PM

Page 1/1

After you search for video clips, you can select any entry and play a clip by clicking **View**. The video clip is played with Axon Player.

Number	Object	Camera	Alarm type	Date	Time
1	47 John Reed str. (550016)	Camera 1 (1)	Vibration sensor	6/26/2018	3:14:04.000 PM
2	47 John Reed str. (550016)	Camera 1 (1)	Vibration sensor	6/26/2018	3:16:19.000 PM
3	47 John Reed str. (550016)	Camera 1 (1)	Vibration sensor	6/26/2018	3:21:22.000 PM
4	47 John Reed str. (550016)	Camera 1 (1)	Vibration sensor	6/26/2018	3:21:44.000 PM
5	47 John Reed str. (550016)	Camera 1 (1)	Vibration sensor	6/26/2018	3:22:18.000 PM
6	47 John Reed str. (550016)	Camera 1 (1)	Vibration sensor	6/26/2018	3:22:27.000 PM
7	47 John Reed str. (550016)	Camera 1 (1)	Vibration sensor	6/26/2018	3:22:02.000 PM
8	47 John Reed str. (550016)	Camera 1 (1)	Vibration sensor	6/26/2018	3:23:21.000 PM
9	47 John Reed str. (550016)	Camera 1 (1)	Vibration sensor	6/26/2018	3:23:44.000 PM
10	47 John Reed str. (550016)	Camera 1 (1)	Vibration sensor	6/26/2018	3:24:16.000 PM
11	47 John Reed str. (550016)	Camera 1 (1)	Vibration sensor	6/26/2018	3:24:41.000 PM
12	47 John Reed str. (550016)	Camera 1 (1)	Vibration sensor	6/26/2018	3:25:04.000 PM
13	47 John Reed str. (550016)	Camera 1 (1)	Vibration sensor	6/26/2018	3:29:05.000 PM
14	47 John Reed str. (550016)	Camera 1 (1)	Vibration sensor	6/26/2018	3:29:33.000 PM
15	47 John Reed str. (550016)	Camera 1 (1)	Vibration sensor	6/26/2018	3:30:01.000 PM
16	47 John Reed str. (550016)	Camera 1 (1)	Vibration sensor	6/26/2018	3:30:25.000 PM
17	47 John Reed str. (550016)	Camera 1 (1)	Vibration sensor	6/26/2018	3:30:37.000 PM
18	47 John Reed str. (550016)	Camera 1 (1)	Vibration sensor	6/26/2018	3:41:39.000 PM
19	47 John Reed str. (550016)	Camera 1 (1)	Vibration sensor	6/26/2018	3:41:47.000 PM
20	47 John Reed str. (550016)	Camera 1 (1)	Vibration sensor	6/26/2018	3:41:58.000 PM
21	47 John Reed str. (550016)	Camera 1 (1)	Vibration sensor	6/26/2018	3:42:07.000 PM
22	47 John Reed str. (550016)	Camera 1 (1)	Vibration sensor	6/26/2018	3:42:14.000 PM
23	47 John Reed str. (550016)	Camera 1 (1)	Vibration sensor	6/26/2018	3:42:32.000 PM
24	47 John Reed str. (550016)	Camera 1 (1)	Vibration sensor	6/26/2018	4:01:19.000 PM
25	47 John Reed str. (550016)	Camera 1 (1)	Vibration sensor	6/26/2018	4:02:47.000 PM
26	47 John Reed str. (550016)	Camera 1 (1)	Vibration sensor	6/26/2018	4:03:46.000 PM
27	47 John Reed str. (550016)	Camera 1 (1)	Vibration sensor	6/26/2018	4:04:10.000 PM
28	47 John Reed str. (550016)	Camera 1 (1)	Vibration sensor	6/26/2018	4:05:06.000 PM
29	47 John Reed str. (550016)	Camera 1 (1)	Vibration sensor	6/26/2018	4:07:16.000 PM
30	47 John Reed str. (550016)	Camera 1 (1)	Vibration sensor	6/26/2018	4:32:53.000 PM
31	47 John Reed str. (550016)	Camera 1 (1)	Vibration sensor	6/26/2018	4:33:21.000 PM
32	47 John Reed str. (550016)	Camera 1 (1)	Vibration sensor	6/26/2018	4:33:25.000 PM
33	47 John Reed str. (550016)	Camera 1 (1)	Vibration sensor	6/26/2018	4:33:29.000 PM

File found in archive



Clip type: "ALARM"

Records processed: 1880

View Close

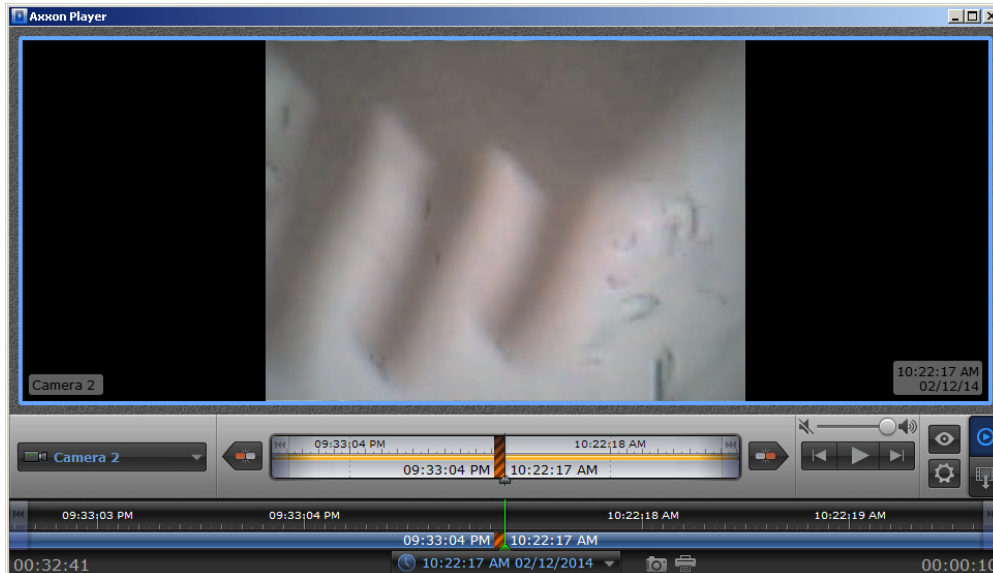

Searching for snapshots and videos is performed through files that have been downloaded using the **Search in archive** component or received with alarms. This search is performed by archive time, but not by download time.

Statistical reports

Rus

To start creating a report, click **Statistics**.



A window opens. In this window, you can set the parameters needed to create the report.

Statistics	
Object description	all objects
Region	all objects
District	all objects
City	all objects
Beginning date	6/26/2018
Beginning time	12:00:00 AM
End date	6/26/2018
End time	04:06:15 PM
Include number of cameras on site	<input checked="" type="checkbox"/>
Include archive errors	<input type="checkbox"/>
Show alarms	<input type="checkbox"/>
Detailed report	<input type="checkbox"/>

OK Cancel

You can set the following report parameters:

1. The time range of the report. Use the **Beginning date**, **Beginning time**, **End date**, and **End time** fields.
2. **Object description**. You can use this field to choose between two report modes:
 1. Report on all the system objects.

2. Report on one system object.

Object description	all objects
Region	all objects
District	10 Green spruce dr.
City	12 Osipenko str. 47 John Reed str.

3. **Include number of cameras on site.** If you select this check box, the non-readiness rates for the cameras and archives are calculated taking into account all the cameras of the object.
4. **Include archive errors.** If you select this check box, the non-readiness rates for the the whole system are calculated taking into account the non-readiness rates for the archives.
5. **Show alarms.** If you select this check box, alarm information from the object(s) is added to the report.
6. If you set the **Object description** parameter to **All objects**, you can edit the **Detailed report** parameter. If you do NOT select this check box, a generalized statistical report on the system is created. If you select the **Detailed report** check box, then **Sorting**, **Sort**, and **Availability factor threshold** parameters become available. In this case, a detailed statistical report on the system is created.

Statistics	
Object description	all objects
Region	all objects
District	all objects
City	all objects
Beginning date	6/26/2018
Beginning time	12:00:00 AM
End date	6/26/2018
End time	04:06:15 PM
Include number of cameras on site	<input checked="" type="checkbox"/>
Include archive errors	<input type="checkbox"/>
Show alarms	<input type="checkbox"/>
Detailed report	<input checked="" type="checkbox"/>
Availability factor threshold	<input type="checkbox"/>
Sorting	without sorting
Sort	descending

7. **Sorting.** This field allows you to sort statistical data by certain criteria.

Detailed report	<input checked="" type="checkbox"/>
Availability factor threshold	<input type="checkbox"/>
Sorting	without sorting
Sort	without sorting

8. **Sort.** Use this field to set the sort order (ascending or descending).

Sorting	without sorting
Sort	descending

9. If you select the **Availability factor threshold** check box, the **Threshold Value (%)** and **Condition** fields become available. Use this fields to sort objects by an additional condition, the threshold for the readiness rate.

Detailed report	<input checked="" type="checkbox"/>
Availability factor threshold	<input checked="" type="checkbox"/>
Threshold value, %	90
Condition	lower than threshold

10. **Threshold Value (%).** Use this field to set a threshold (between 0 and 100 %).

11. **Condition.** Use this field to set an object filtering condition: **lower than threshold** or **higher than threshold**.
12. If you set the **Object description** field to a certain object, you can edit the **Provide info about alarms** and **Provide info about failures** parameters. Select these check boxes if you want to include detailed information on failures and alarms in the report.

Statistics	
Object description	10 Green spruce dr.
Beginning date	6/26/2018
Beginning time	12:00:00 AM
End date	6/26/2018
End time	04:06:15 PM
Include number of cameras on site	<input checked="" type="checkbox"/>
Include archive errors	<input type="checkbox"/>
Show alarms	<input type="checkbox"/>
Provide info about alarms	<input type="checkbox"/>
Provide info about failures	<input checked="" type="checkbox"/>

After you configure all the parameters, click **OK**.
The following figure shows a sample report on one object.

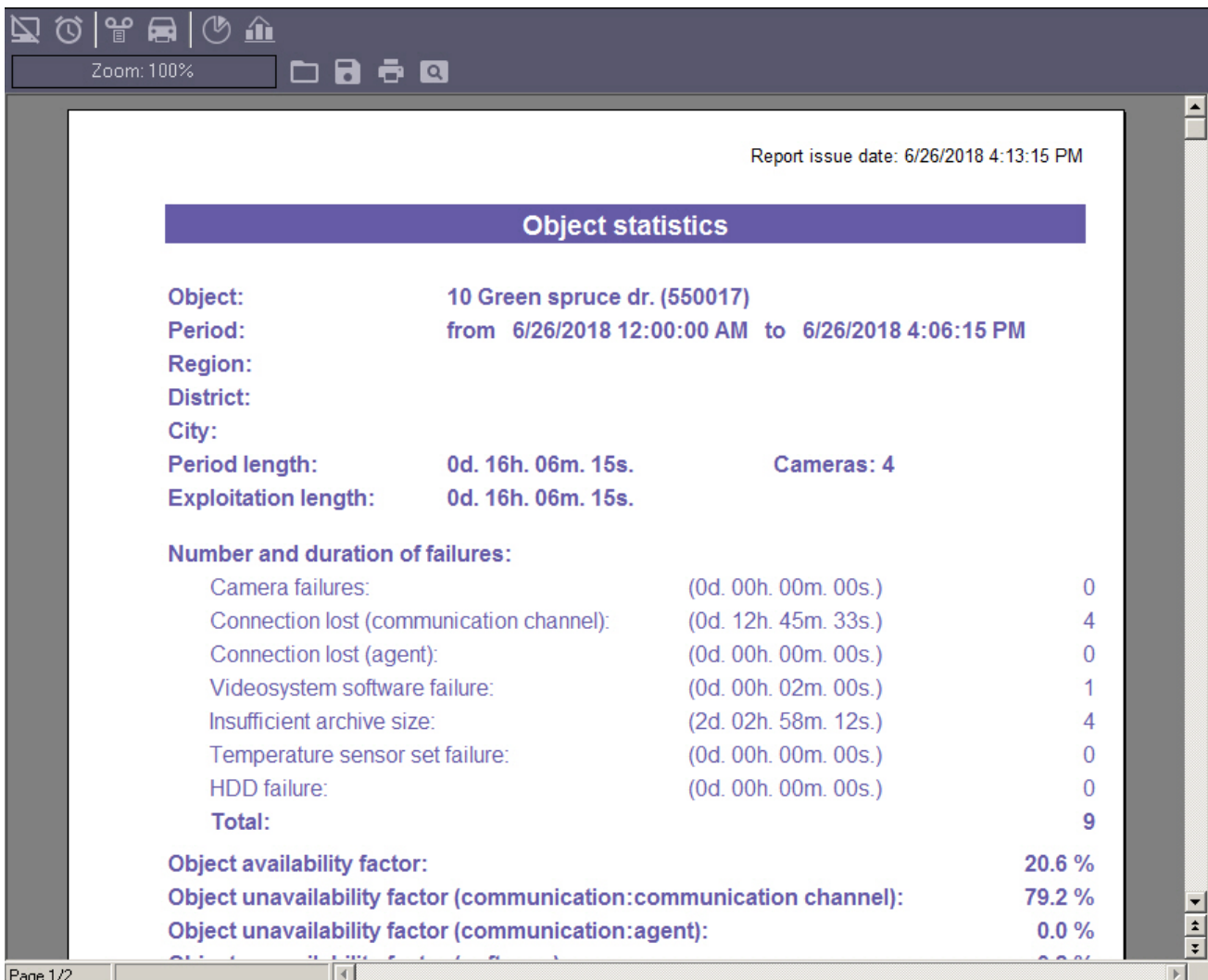

The following figure shows an example of different failures at an object. Then readiness and non-readiness rates are calculated.

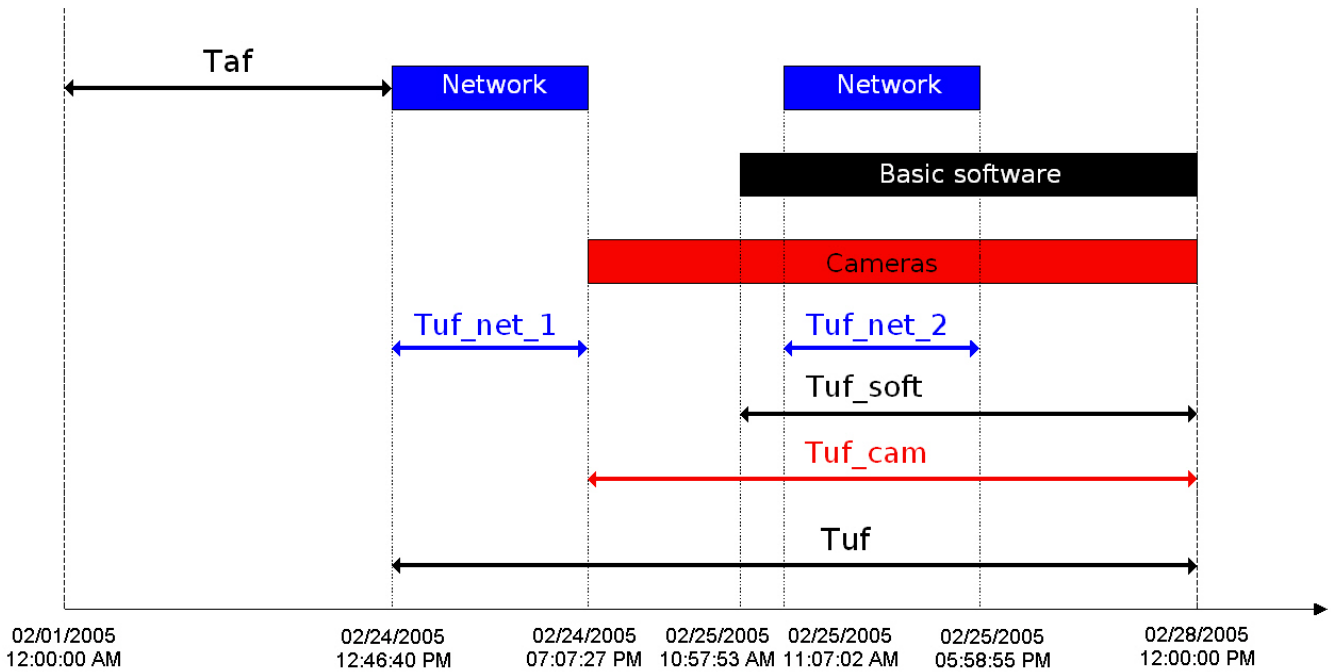

This example uses the time period from 12 a.m. on February 1, 2005, to 12 p.m. on February 28, 2005, to create a statistical report. The readiness rate of an object is calculated as a ratio between the duration of the time period when the object was functioning and the duration of the time period used for the report:

$$Rr = Taf / (Taf + Tuf)$$

The following types of failure are used for reports:

- Connection
- Core software
- Cameras

The non-readiness rates of the object in our example are calculated according to the below formulas.

Connection non-readiness:

$$Rn_c = (Tuf_net_1 + Tuf_net_2) / (Taf + Tuf)$$

Software non-readiness:

$$Rn_{sw} = Tuf_soft / Taf + Tuf$$

Camera non-readiness:

$$Rn_{cam} = Tuf_cam / Taf + Tuf$$

Generally, in this model, the non-readiness rate Rn is not equal to the sum of all the non-readiness rates for all failures.

The following figure shows a sample general report for the entire system. The readiness and non-readiness rates in the report are calculated as the arithmetic mean.

Zoom: 100%

Report issue date: 6/26/2018 4:15:53 PM

System statistics

Number of objects: 2 (availability factor lower than 90 %)
Period: from 6/26/2018 12:00:00 AM to 6/26/2018 4:06:15 PM
Region: all objects
District: all objects
City: all objects
Duration: 0d. 16h. 06m. 15s. **Cameras: 5**

Number of failures:

Camera failures:	0
Connection lost (communication channel):	7
Connection lost (agent):	0
Videosystem software failure:	2
Insufficient archive size:	5
Temperature sensor set failure:	0
HDD failure:	0
Total:	14

System availability factor: 20.7 %
System unavailability factor (communication:communication channel): 79.1 %
Svstem unavailitiv factor (communication:agent): 0.0 %

Page 1/2

When you create a detailed report for the entire system, in addition to the general information page, you get a table that contains detailed data for each object.

Object	Number of failures							Kg, %	UF_com (chan.), %	UF_com (agent), %	UF_sw, %	UF_cam, %	UF_hdd, %	UF_arc, %
	Cameras	Com. (chan.)	Com. (agent)	Software	Archive	Temp. sens. set	HDD		UF_com (chan.), %	UF_com (agent), %	UF_sw, %	UF_cam, %	UF_hdd, %	UF_arc, %
Partition Of Control 1	0	2	0	0	0	1	0	91.5	8.5	0	0	0	0	0

If you select the **Readiness rate threshold** check box when you create a detailed report for entire system, the first page looks as shown in the following figure.

Attention!

If you create a statistical report on all the objects and a number of failures for the specified period exceeds 1000 for a particular object, then such object is excluded from the report. In this case, a list of such objects is shown.

Statistical reports by owners

Rus

This type of report uses only objects for which the **Owner** field is filled in in the **Monitoring objects** reference book (see the **Filling out reference books** section). To start creating a report, click **Statistics by owners**.



A window opens. In this window, you can set the parameters needed to create the report.

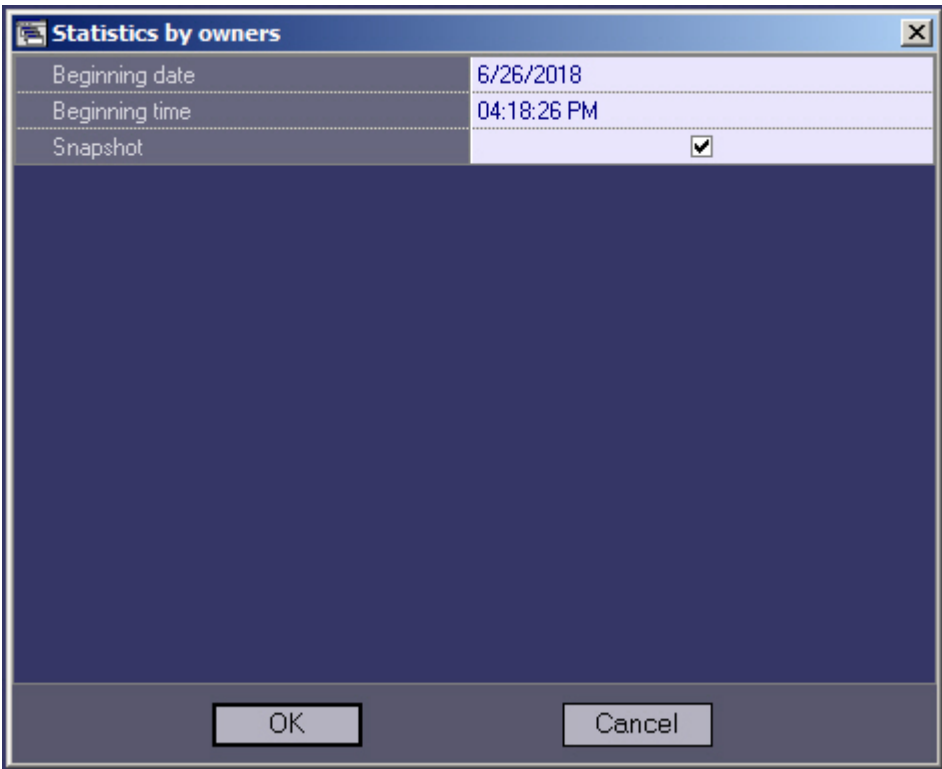

You can set the following report parameters:

1. The time range of the report. Use the **Beginning date** and **Beginning time** fields.
2. **Snapshot**. If you select this check box, the report is created for the specified date and time. Otherwise, the report is created for the entire day specified in the **Beginning date** field.

The following figure shows a sample statistical report by owners.

Report issue date: 6/26/2018 4:18:46 PM

Statistics by owners (from 6/26/2018 4:18:26 PM to 6/26/2018 4:18:27 PM)

№	Owner name	Total objects (total with errors)	General availability factor, %	Unavailability factor in % (number)					
				Cameras	Connection with object	Connection with monitoring agent	Software error	Archive	HDD error
1	Moscow subsidiary	1 (0)	100.0	0.0 (0)	0.0 (0)	0.0 (0)	0.0 (0)	0.0 (0)	0.0 (0)
2	Samara subsidiary	1 (1)	0.0	0.0 (0)	100.0 (1)	0.0 (0)	0.0 (0)	0.0 (0)	0.0 (0)
3	Yakutsk subsidiary	1 (0)	100.0	0.0 (0)	0.0 (0)	0.0 (0)	0.0 (0)	0.0 (0)	0.0 (0)
TOTAL :		3 (1)	66.7	0.0 (0)	33.3 (1)	0.0 (0)	0.0 (0)	0.0 (0)	0.0 (0)

Vehicle LPs report

To start creating a report, click **Vehicle LPs**.



A modal window opens. In this window, you can set the parameters needed to create the report.

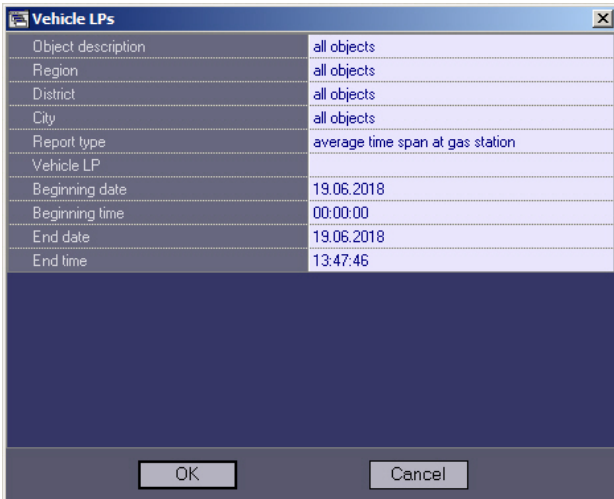

You can set the following report parameters:

1. The time range of the report. Use the **Beginning date**, **Beginning time**, **End date**, and **End time** fields.
2. **Object description**. You can use this field to choose between two report modes:
 1. Report on all the system objects.
 2. Report on one or several system objects.

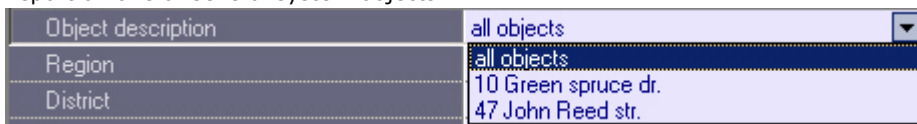

3. **Region**. Select one or more regions.



4. **District**. Select one or more districts.



5. **City**. Select one or more cities.



6. **Report type**:

1. average time span at gas station
2. number of vehicles
3. list of LPs



7. **Vehicle LP** number. With this parameter, you can specify the LP number of the vehicle, the information about which should be included in the report. The LP number can be specified in full or with a mask containing the following symbols:

- % to replace several symbols;
- _ - to replace one symbol.

Note.

For example, if you specify **T4%**, the report includes information on vehicles with LP starting with **T4**.



8. After setup of all parameters, click **OK**. The report is displayed in a separate window.

Special operation mode joint with Auto Intellect



In the special operation mode joint with *Auto Intellect*, *Agent of Control* intercepts the **LP recognized** event and transfers information on this event to the *Server of Control*. This information is NOT visualized as an alarm but is saved in the *Server of Control* database. The **Info on vehicle license plates** button also becomes available to open **License plate search** window (see [Viewing recognized LPs](#)). This allows searching external plates databases.

Interface of the License plates search window

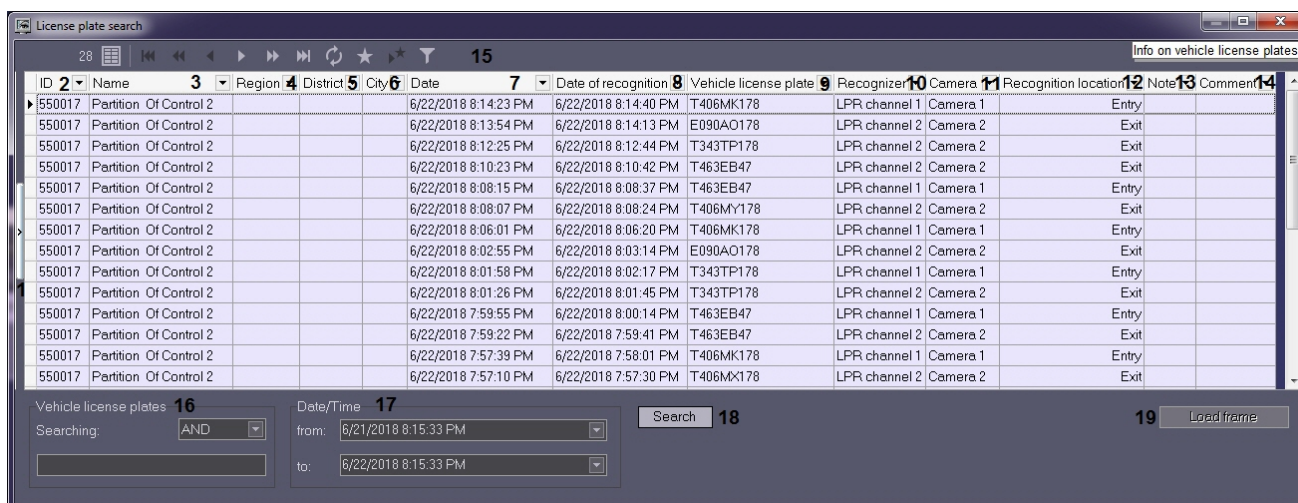
See appearance of the **License plates search** window on the picture below.



Description of the **License plates search** window interface:

1	 <p>The button similar to  (Show inspector Ctrl+I) in the license plates search panel. Opens custom information panel. Information on the selected event is shown in the top of this panel.</p>
2	Unique object ID is shown in the ID column (see Configuring Agent of Control and Configuring Server of Control).
3	Partition of control name is displayed in the Name column.
4	The area where the object is installed is displayed in the Area column.
5	The district where the object is installed is shown in the District column.
6	The city where the object is installed is displayed in the City column.
7	The date of alarm is displayed in the Date column (see also Data loading to the database)
8	Date when the frame from the camera was recognized is shown in the Date of recognition column.
9	Vehicle LP is shown in the Vehicle license plate column.
10	Name of the recognition module is shown in the Recognizer column.
11	Name of the camera from which the frame was received is shown in the Camera column.
12	Recognition point (entrance or exit) is shown in the Recognition location column.

13	Name of the External plates DB object is shown in the Note column.
14	In the Comment column, the additional information for the LP is shown, if it was specified while adding the LP to the External plates DB .
15	License plates search panel (see Interface of the License plates search panel).
16	The Vehicle license plates area is intended to search for LPs by a known LP number or by mask with search conditions.
17	The Date/Time area allows searching events for a specified period of time.
18	Click Search button to run the search.
19	The Load frame button is for downloading the frame on which the LP was recognized.

Interface of the License plates search panel

See appearance of the **License plates search** panel on the picture below.



Description of the buttons on the **License plates search** panel:



(Show inspector Ctrl+I): when this button is pressed, a special area is displayed, at the top of which a brief information about the currently selected record is listed.



(First record): when this button is pressed, the first registered event records are displayed.



(Previous page): when this button is pressed, the previous page with event records is displayed, if present.



(Previous record): when this button is pressed, the previous event record is selected relative to the currently selected record.



(Next record): when this button is pressed, the next event record is selected relative to the currently selected record.



(Next page): when this button is pressed, the next page with event records is displayed, if present.



(Last page): when this button is pressed, the last registered event records are displayed.



(Update data): when this button is pressed, the displayed data are updated.



(Define bookmark): when this button is pressed, the current page with event records is added to the bookmark, which you can access later with the **(Go to bookmark)** button.



(Go to bookmark): when this button is pressed, the page with event records that was previously added to the bookmark is opened.



(Filter editor): when this button is pressed, the **Filter builder** window is opened (see [Custom filter in the Log Panel](#))

Viewing recognized LPs

In order to view details on recognized license plates, click the **Info on vehicle license plates**  button on the **Log panel** or in the **Details** window in the **Monitoring** interface. The **License plates search** window opens.

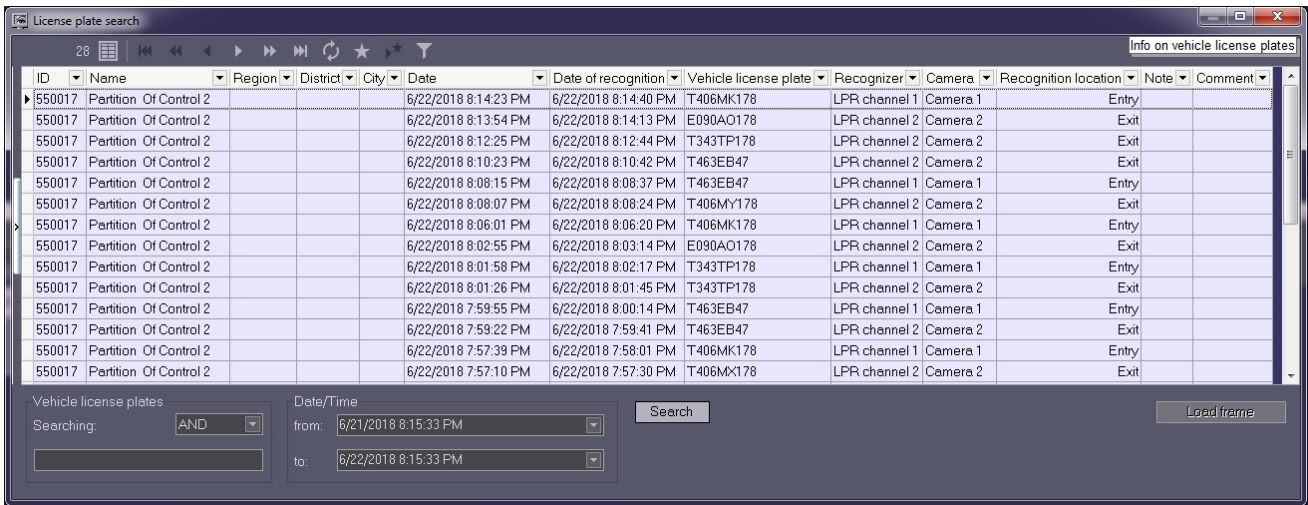

In the Date/Time area in this window, the period to search LPs in can be specified. For this:

1. In the **from:** (1) field set the date and time to start search from.
2. In the **to:** (2) field set the date and time to stop search at.

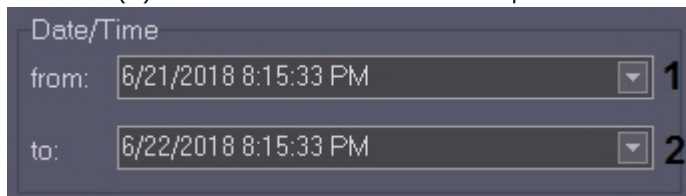

3. Click **Search** (3) to run the search.

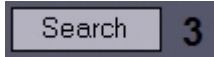

In the **Vehicle license plates** area, the search by a known LP number or by mask with search conditions can be performed. For this:

1. In the **Search operation** field (1) choose the search condition: **AND** or **OR**.
2. In the (2) field enter the fill LP number or use the following mask symbols:

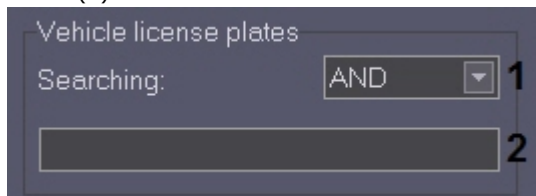

- % - to replace several characters;;
- _ - to replace one character.

Note.

For example, when **T4%** is entered, the report is built for vehicles with LP starting from **T4**.

3. Click **Search** (3) to run the search.

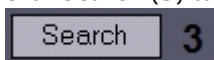

The frame on which the LP number was recognized can be downloaded. For that, select the record in the list and click **Load frame** (1). The frame is downloaded and displayed (2).

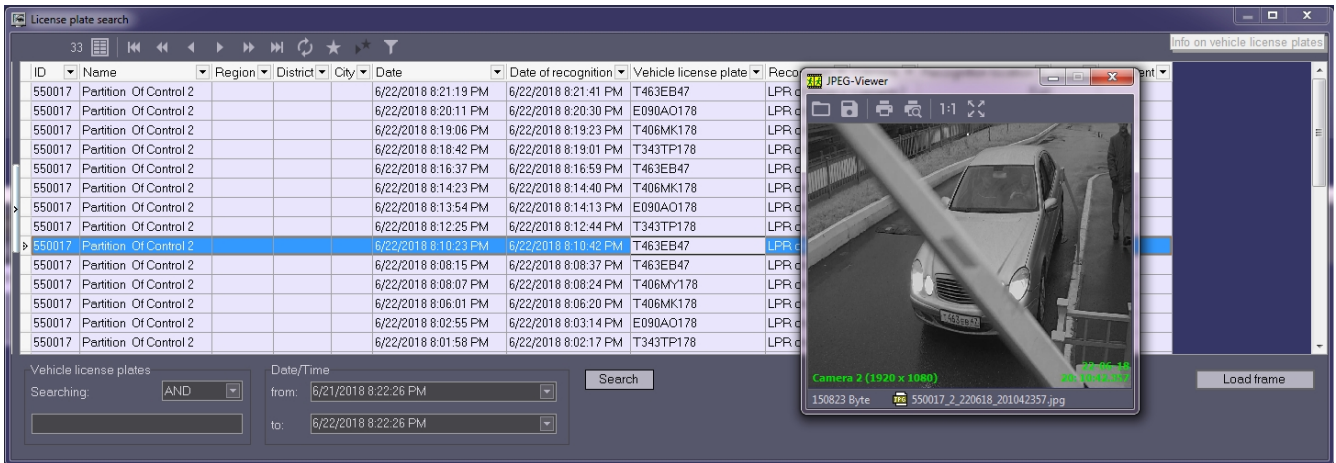

Important!

The **Search in archive** object on the **Interfaces** tab must be created to load frames from the **License plates** search window.

Records with frames already downloaded are highlighted in bold. These frames can be viewed any time by double clicking the record.

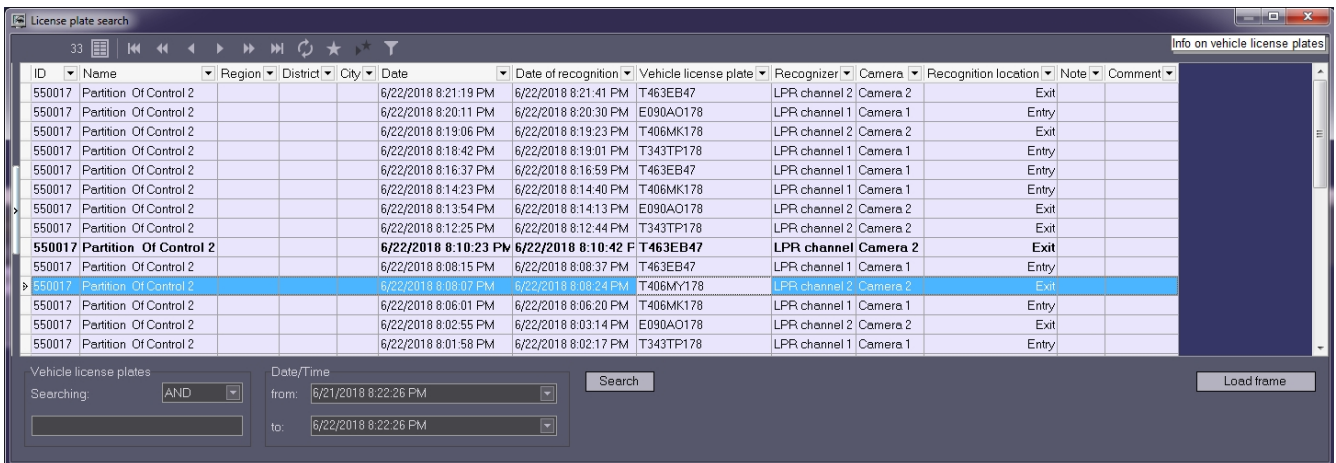

Note.

Information about frames downloading can be found in the **Search in archive** request log.

ID	Object name	Camera	Date and time of requested video clip	Type	Status	Loaded, %	Requested length, sec.	Date and time of planned start	Size, KB	Speed, KBps	Received KB	Xml	Comment
550017	Partition Of Control 2	Camera 2 [2]	6/22/2018 8:10:42:357 PM	Frames	Ready	100%		6/22/2018 8:22:51 PM	147	0	147		

Upon receiving an event about the recognized number, *Server of Control* can search for a number in one or more external databases. An alarm is generated on *Server of Control* if the LP is found in the External DB. The alarm is sent to the *Agent of Control*.

Note.

The **Alarm message window** object is to be created on the **Hardware** tab to visualize the alarm in a pop-up window (see *Alarm message window*).

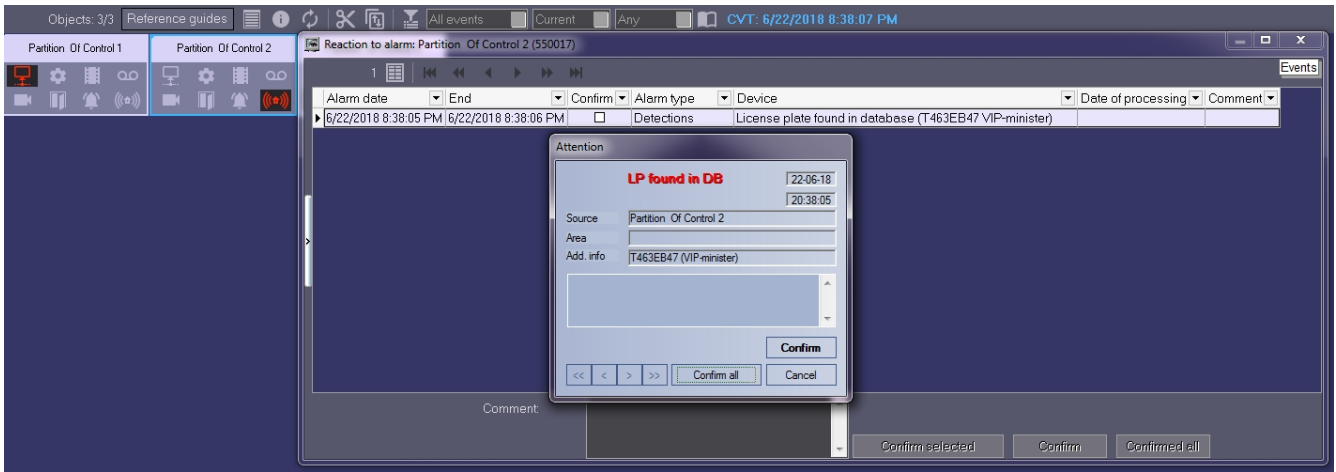

The records of LPs found in an external DB are highlighted in red in the **License plates search** window. Name of the **External plates DB** object is shown in the **Note** column. In the **Comment** column, the additional information for the LP is shown, if it was specified while adding the LP to the **External plates DB**.

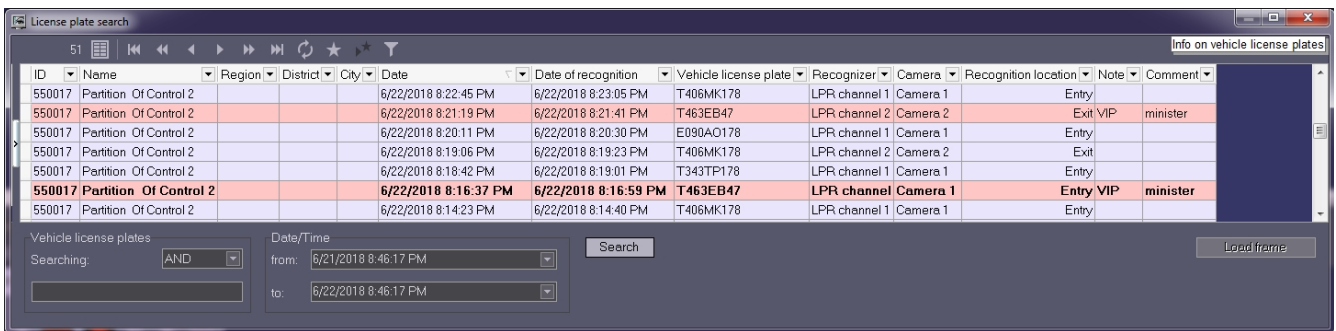

Note.

If connection is lost between *Server of Control* and *Agent of Control*, the *Agent of Control* stores the information on the recognized vehicle LPs locally. When the connection is restored, the *Agent of Control* sends saved LPs to *Server of Control*.

Controlling unregistered objects

Rus

If an object that is not registered in the *Server of Control* settings (*Intellect*, the **Hardware** tab) connects to *Monitoring*, a dialog box opens and shows a warning for the operator. The message box informs about the unregistered object.

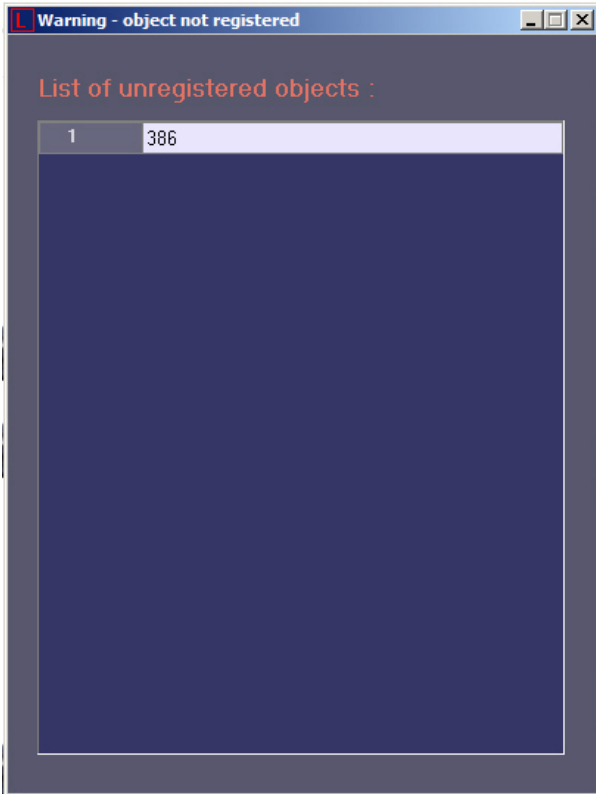

Appendix 1. Data update periods summary

Data loading from database to the interface objects

Rus

Information on Control panel and Log panel is updated every time data is loaded **from** the database. The time of the last download from the database is shown in the CVT field.

Periods of data updating are different for Control panel and Log panel:

1. Control panel.
 1. Data are updated from the database once a minute (by timer).
 2. At receiving of a command from Data loader to forcibly update information, which can appear after a new load to the database.
2. Log panel. Data are updated from the database once a minute (by timer).

To get the latest database information, click the button  (Refresh data). This forces the data to load.

Data loading to the database

Rus

The date of last load of data **to** the database (see section [Moving through the list of alarms](#)) is refreshed when changes in the database appear.

If there is no any change in the database in 5 minutes, the CVT field is forcibly updated and then is updated once a minute. At the same time there will be a gap from the current system time by 5 minutes. After coming of new information from any of the *Agent of Control*, the CVT become equal to the current system time of the computer.

Loading data to the database is performed by the *Data loader for Monitoring* module.

If files with technical information are received from *Agents of Control* (e.g. camera enabled), these files are loaded to the database with a period specified while configuring *Data loader* in the **Loading period** parameter (10 seconds by default). If files with information on alarms are received from *Agents of Control* (e.g. vibration sensor triggered), this information is loaded to the database immediately.

After each load to the database, a message is sent to the **Control panel** interface component to update the information.

If, after receiving files with technical condition, *Server of Control* determines that object state has not changed, then nothing is loaded to the database. This is why the timer is used to forcibly update interfaces (see section [Data loading from database to the interface objects](#)).

In the **Alarm date** field in the interface objects, the time of alarm information load to the database after receiving it from the *Agent of Control* is displayed, not the time of alarm appearing at the site.

Note.

To enable alarm registration with the time it emerged on site, create the `TimeAlarmFromAgent` key in the Windows registry and set it to 1 (see [Registry keys reference guide](#) for more details on the key and the [Working with Windows OS registry](#) section of Intellect software. Administrator's Guide for more details on how to operate registry keys).

Sending data from Agent of Control to Server of Control

Rus

Agent of Control sends to *Server of Control* packages with its technical condition with a period set while setting the **Partition of Control** object at the *Agent of Control* side using the **Ping frequency** parameter (see [Monitoring. Administrator's Guide](#), section [Configuring communication between Agent of Control and Server of Control](#)). The default ping frequency is 2 minutes (120 seconds).

Information on long-term alarms comes to the *Server of Control* from *Agent of Control* together with the information on technical condition, with the ping period.

Information about short-term alarms comes to the *Server of Control* immediately after they have appeared at the *Agent of Control*.

Data transmission scheme

Rus

The picture gives a general scheme of data transferring from *Agent of Control* to *Server of Control*.

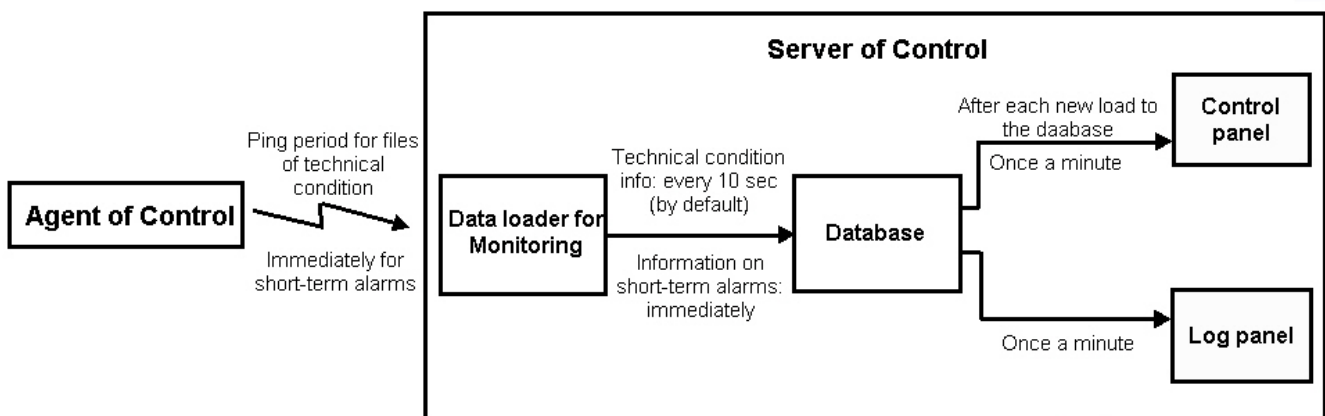

Features of displaying information on short-term and long-term alarms

Rus

Information about long-term alarm can be not recorded into the *Monitoring* database and not displayed in its interfaces in the following cases:

1. If a long-term alarm had started and ended within two polls of *Agent of Control* (within the **Ping frequency** interval, see [Monitoring. Administrator's Guide](#)).
2. If a long-term alarm had started and ended when the connection between *Agent of Control* and *Server of Control* was lost.

When there is no connection with *Server of Control*, the short-term alarms are stored in the "holding" data files on the *Agent of Control*. When connection with *Server of Control* is restored, they are transferred to the *Server of Control*, stored in the *Monitoring* database and displayed in its interfaces.

Agent of Control technical condition data collection periods

Rus

Agent of Control technical condition data collection periods are given below:

1. Information on disk failures (the Disk failure alarm type) and its restoring is updated in the following cases:
 1. at *Agent of Control* startup and then every 15 minutes.
 2. at receiving local message SLAVE|NO_DISC (No disk for archive storage) from Intellect core.
 3. at receiving local message DISC_EXIST (Disk for archive storage found) from Intellect core.
 4. at receiving local message DISC_UNMOUNT (Disk unmounted) from Intellect core.
 5. at receiving local message DISC_MOUNT (Disk mounted) from Intellect core.
2. Information on archive size (the Small archive size alarm type) is updated at *Agent of Control* startup and then every 15 minutes.
3. Information on the computer normal and abnormal restarts is displayed in the interface within 5 minutes.
4. Information on free disk space is updated every 1 hour.
5. *Agent of Control* initiates the connection with *Server of Control* and once in a ping period (2 minutes by default) sends a package with technical data to the *Server of Control*. If *Server of Control* haven't been receiving any data from *Agent of Control* for 6 minutes, the "No connection" error is displayed for such object.
6. The Video.run process status (hangup) is checked at startup of Videosrv.exe module and then every 15 minutes, and besides that each time the Videosrv.exe module reconnects with the *Intellect* software, i.e. if the *Intellect* software was shut down and started again.
7. Availability of running processes "Intellect.exe" and "Video.run" is checked every 10 seconds.