



Installing and Configuring Security System Components Guide

1. Installing and configuring security system components guide. INTRODUCTION	7
2. Installing security system components	7
2.1 Assembly and installation of video surveillance subsystem hardware	7
2.1.1 Installing video capture cards into computer case	8
2.1.2 Installing drivers for video capture cards	10
2.1.3 Testing installation of drivers for video capture cards	16
2.1.4 Testing installation of drivers for video capture cards using the Codereader.exe utility	19
2.1.5 Characteristics of Driver Pack updating for YUAN cards	20
2.2 Installing the expansion card for analog video out	21
2.3 Connecting the hardware performance testing	23
2.3.1 Connecting the Watchdog hardware performance tester	23
2.3.2 Connecting the USB Watchdog hardware performance tester	26
2.4 Connecting Sensor-Relay cards	29
2.4.1 Connecting 4/4 and 16/4 Sensor-Relay cards	29
2.4.2 Connecting 4/4 Sensor-Relay (low profile) cards	35
2.4.3 Connecting SL USBIO (4x4, 16x8 and 24x4) cards	42
2.4.4 Connecting MO USBIO 4x4 cards	46
2.4.5 Connecting Sensor-Relay (Stretch) cards	48
2.4.5.1 Connecting Sensor-Relay cards to Stretch (VRC6004, VRC6008, VRC6416) cards	49
2.4.5.2 Connecting Sensor-Relay cards to Stretch VRC7008L card	50
2.5 Connecting MO USBIO 4x4 external module	52
2.6 Assembling and installing hardware components of audio subsystem	53
2.7 Connecting PTZ devices and control panels	54
2.8 Connecting and configuring network devices	55
3. Configuring security system components in INTELLECT™ software	55
3.1 Configuring video capture cards in INTELLECT™ software	55
3.1.1 Video subsystem configuration	55
3.1.1.1 Creating and configuring the Video Capture Device object	56
3.1.1.2 Creating and configuring the Camera object	60
3.1.1.3 Configuring the analog video output	63
3.1.1.4 Configuring Stretch video capture card	65
3.1.1.5 Configuring HikVision video capture card	67
3.1.2 Audio subsystem configuration	68
3.1.2.1 Creating and configuring the Audio card object	68
3.1.2.2 Creating and configuring the Microphone object	70
3.1.3 Initial configuration wizard	72
3.1.4 Configuring the Watchdog hardware performance tester	74
3.2 Configuring IP devices	76
3.2.1 General information on IP devices	76

3.2.2	Configuring video acquisition from IP devices	77
3.2.3	Configuring audio acquisition from IP devices	77
3.2.4	Camera discovery tool	78
3.2.5	Connecting devices over standard protocols	82
3.2.5.1	Configuring multimedia receipt using RTSP protocol	82
3.2.5.2	Connecting cameras via the GB/T28181 protocol	85
3.2.5.3	Connecting cameras via the ONVIF protocol	87
3.2.5.4	Using General Device drivers	88
3.2.6	Features of IP device configuration	89
3.2.6.1	Features of Beward IP cameras configuration	89
3.2.6.2	Features of Panasonic IP devices (i-Pro series) configuration	89
3.2.6.3	Features of TrendNet IP device configuration	89
3.2.6.4	Features of Pelco Spectra IV IP device configuration	90
3.2.6.5	Features of AEBELL IP device configuration	90
3.2.6.6	Features of Dynacolor IP device configuration	90
3.2.6.7	Features of Stream Labs IP device configuration	90
3.2.6.8	Features of Cisco IP device configuration	91
3.2.6.9	Features of Mobotix IP device configuration	92
3.2.6.10	Characteristics of joint operation of Jassun and Bosch cameras	92
3.2.7	Changing the transport protocol used by IP-device	92
3.2.8	Digest authentication when accessing IP device	93
3.3	Configuring Sensor-Relay devices in INTELLECT™ software	94
3.3.1	Creating and configuring the Relay system object	94
3.3.2	Creating and configuring the Sensor system object	95
3.3.3	Configuring Sensor-Relay expansion cards	97
3.3.3.1	How to configure relay connection	97
3.3.3.2	How to configure sensor connection using 4/4 Sensor-Relay card	100
3.3.3.3	How to configure sensor connection using 16/4 Sensor-Relay card	103
3.3.4	Configuring Sensor-Relay expansion cards (low profile)	106
3.3.4.1	Connecting relays of 4/4 Sensor-Relay expansion cards (low profile)	106
3.3.4.2	Connecting sensors of 4/4 Sensor-Relay expansion cards (low profile)	109
3.3.5	Configuring SL USBIO cards	111
3.3.6	Configuring MO USBIO 4x4 devices	112
3.3.6.1	Connecting relays MO USBIO 4x4	112
3.3.6.2	Connecting sensors MO USBIO 4x4	114
3.3.7	Configuring Sensor-Relay (Stretch) cards	116
3.3.8	Configuring sensors and relays connected via IP devices	117
3.4	Telemetry configuration	118
3.4.1	Use of PTZ devices in the digital video surveillance system	118

3.4.2	Priorities of PTZ control	119
3.4.3	Configuring PTZ devices (telemetry)	121
3.4.3.1	PTZ device setting procedure	122
3.4.3.2	Configuring Server ports and remote workstation to connect PTZ devices	122
3.4.3.3	Configuring PTZ devices in INTELLECT™	124
3.4.4	Configuring Control panel	125
3.4.4.1	Features of BOSCH KBD-Digital or BOSCH KBD-Universal control panel configuration and operation	126
3.4.4.2	Features of Axis T8310 control panel configuration and operation	130
3.4.4.3	Features of Lilin PIH-800III control panel configuration and operation	135
3.4.4.4	Features of Panasonic WV-CU950 control panel configuration and operation	138
3.4.4.5	Features of Samsung SSC-2000 control panel configuration and operation	142
3.4.4.6	Features of Everfocus EKB-200 control panel configuration	143
3.4.4.7	Features of Samsung SPC-7000 control panel configuration	143
3.4.5	Configuring PTZ IP cameras	145
3.4.5.1	Configuring control of PTZ IP camera using the control panel	146
3.4.5.2	Features of Vivotek Panoramic PTZ configuration	146
3.4.6	Telemetry control panel configuration	147
3.4.7	Creating and configuring the Operator query panel for telemetry control	149
3.4.8	Configuring the Monitor for telemetry control	151
3.4.9	Configuring the joystick for telemetry control	151
3.4.9.1	Joystick setting procedure	151
3.4.9.2	Testing joystick functioning	152
3.4.9.3	Assigning commands to joystick buttons for telemetry control	154
3.4.9.3.1	Assigning commands to joystick buttons using Registry Editor	155
3.4.9.3.2	Assigning commands to joystick buttons using the Monitor	157
3.4.10	Configuring the mouse buttons to control PTZ devices	158
4.	Installing and configuring security system components guide. CONCLUSION	160
5.	Appendix 1. Features of video capture card configuration	161
5.1	Drivers for video capture cards integrated into INTELLECT™	161
5.2	Features of video subsystem configuration	162
5.3	Features of audio subsystem configuration	164
6.	Appendix 2. IP device configuration in the Windows OS	167
6.1	Configuration of IP devices by the example of Axis camera	167
6.1.1	Searching for IP devices	167
6.1.2	Assigning network addresses to IP devices	168
6.1.3	How to call the Web Server home page of IP device	173
6.1.4	Configuring network parameters of IP-devices using the Web Server	176
6.2	Features of configuring Axis IP devices	180
6.3	Features of configuring IP devices using the Web interface	181

7. Appendix 3. Installing the Matrix Linux Server and LinuxHub	182
7.1 Introduction	182
7.2 Installing Linux Server (LinuxHub)	184
7.2.1 Connecting and running Linux Server (LinuxHub)	184
7.2.2 Network identification of Linux Server (LinuxHub)	185
7.2.3 Configuring Linux Server for INTELLECT™ operation	188
7.2.4 Configuring LinuxHub for INTELLECT™ operation	191
7.2.4.1 Setting up frame resolution	194
7.3 Web interface of Linux Server (LinuxHub)	195
7.3.1 Access to Web interface	196
7.3.2 Viewing video	197
7.3.3 Monitoring state of rays and relays	197
7.3.4 Monitoring Linux Server (LinuxHub) operability	198
7.3.5 Configuring Linux Server (LinuxHub) network parameters	199
7.3.6 Configuring the Linux Server (LinuxHub) logging	200
7.3.7 Configuring parameters of video stream displaying	201
7.3.8 Setting Linux Server (LinuxHub) security	202
7.3.9 Resetting Linux Server (LinuxHub) configuration	203
7.3.10 Viewing Linux Server (LinuxHub) logs	204
7.3.11 Working with memory dumps	205
7.4 Updating Linux Server (LinuxHub) firmware	206
8. Appendix 4. Technical specifications of video capture cards	207
9. Appendix 5. Video capture cards pins	216
9.1 FS-5 video capture card pins	217
9.2 FS-6 video capture card pins	217
9.3 FS-16(Exp) video capture card pins	218
9.4 FS-8 video capture card pins	219
9.5 WS-7 video capture card pins	220
9.6 SC390N16 (WS-16) video capture card pins	221
9.7 WS-17 video capture card pins	222
9.8 SC3B0N16 (WS216) video capture card pins	223
9.9 SC200Q4 (FS15) video capture card pins	226
9.10 SC300D16 (FX8) video capture card pins	226
9.11 SC300Q16 (FX4) video capture card pins	227
9.12 SC310N16 (FX16) video capture card pins	228
9.13 SC200Q4 Low profile (FS115) video capture card pins	231
9.14 FX116 video capture card pins	231
9.15 FX416 video capture card pins	232
9.16 VRC6004 video capture card pins	233

9.17 VRC6008 video capture card pins	233
9.18 VRC6416 video capture card pins	234
9.19 VRC7008L video capture card pins	235
9.20 VRC6404 HD video capture card pins	236
9.21 SC510N4 (FX HD4) video capture card pins	236
9.22 DS-4016HCI(R) video capture card pins	237
9.23 MS416 video capture card pins	238
9.24 SC230N4 video capture card pins	239
9.25 SC590N4 video capture card pins	239
9.26 SC330Q16 video capture card pins	240
9.27 SC330D16 video capture card pins	241
10. Appendix 6. Electrical and technical specifications of Sensor-Relay cards	241
10.1 Electrical and technical specifications of Sensor-Relay cards	241
10.2 Electrical and technical specifications of 4/4 Sensor-Relay (low profile) cards	242
10.3 Electrical and technical specifications of MO USBIO 4x4 devices	243
10.4 Electrical and technical specifications of SL USBIO (4x4, 16x8 and 24x4) card	243

Installing and configuring security system components guide.

INTRODUCTION

On the page:

- Purpose and structure of the guide
- Purpose of the INTELLECT™ software package

Purpose and structure of the guide

[Installing and configuring security system components guide](#) is a reference and information guide that is designed for system administrators, installation and configuration engineers, users with the rights to administrate *INTELLECT™*-based digital video surveillance and audio surveillance systems.

This guide contains the following information on:

1. how to install security system components.
2. how to configure security system components in the *INTELLECT™* software.
3. appendixes that contain supplemental information on security system components and features of their configuration.

Purpose of the INTELLECT™ software package

The *INTELLECT™* software is designed for the deployment of industrial scalable, flexible (adjustable) integrated security systems, based on the digital video surveillance and audio monitoring systems.

The *INTELLECT™* software possesses the following basic features:

1. Integration of digital video surveillance and audio monitoring systems with the existing data systems, various security equipment, auxiliary software of other developers, using integrated open interfaces of the data exchange.
2. Compatibility with diverse security devices and data systems, in particular, with the fire and security alarm and access control systems, video cameras, data analysis systems and systems for recognition of objects (events) and identification by their images.
3. Single-source registration and processing of events, generation of notifications and controlling response in accordance with the flexibly modified logics.

Ultimately unlimited capabilities for scaling, solution—specific adjustments, re-distribution of resources with changes in the number or quality of tasks in monitoring guarded locations and operating various equipment.

Installing security system components

An *INTELLECT™*-based security system consists of hardware kit that fit the functionality of the basic software kit. This section outlines the procedures for configuring basic hardware components of the security system.

Assembly and installation of video surveillance subsystem hardware

The video surveillance subsystem of the *INTELLECT™* software can include the following hardware components:

1. FS/WS/FX/VRC video capture cards and analogue video cameras connected to them. Information on how to install video capture cards is given in the following chapter.

2. Network video cameras and network video servers connected to the Server via the TCP/IP telecommunication protocols. Installation and configuration procedures for this hardware are outlined in the documentation supplied with the network device.
3. Expansion cards for analogue video signal output that are installed in the video capture cards in order to transmit a video signal to analogue monitors.

Installing video capture cards into computer case

One or more video capture card is included into the kit of *INTELLECT™*-based digital video surveillance system.

FS-5B, FS-6B, FS-6C, FS-8, WS-7, SC200Q4 (FS15), SC200Q4 Low profile (FS115), SC230N4 and DS4016HCI video capture cards are connected to the PCI interface version 2.1 and higher; FS-16, SC390N16 (WS16), SC3B0N16 (WS216), WS-17, SC300D16 (FX8), SC300Q16 (FX4), FX116, VRC6004, VRC6008, VRC7008L, SC590N4, SC330D16 (analogue of SC300D16) and SC330Q16 (analogue of SC300Q16) video capture cards are connected to the PCI-express (PCI-E X1) interface; FX416, MS416, SC310N16 (FX16), SC510N4 (FX HD4), VRC6416 and VRC6404HD video capture cards are connected to the PCI-express (PCI-E X4) interface. Installation procedure of video capture cards resembles the installation procedure of standard PCI or PCI-express (sound, network, etc.) cards.



Note

Standard precautions should be observed while installing the video capture cards into a computer case.

Install video capture cards as follows:

1. Turn the computer off and *disconnect* the *plug* from the mains.
2. Remove the computer case cover.



3. Install the video capture card in a free PCI-E X1 slot of the motherboard. Secure the video capture card with a screw.



Note

Before encasing video capture cards, make sure that your hands are free from static electricity, which can damage computer cards and video capture cards. To prevent damage to the cards, various special antistatic tools may be used (for instance, an antistatic wristband).



Example of FS-6C video capture card installation into a PCI slot.



Example of FS-16 video capture card installation into a PCI-E X1 slot.

4. Set the computer case cover.



5. Connect the interface cable with the numbered BNC-pins to the video capture card.



6. Connect video cameras to the interface cable.



7. Connect the power cord of the computer case to the mains and turn the computer on.

8. While the operating system is loading, new hardware (video capture card) is found and the monitor displays the **Found New Hardware Wizard** dialog box.

If *INTELLECT™* is to be installed on the given computer, then click the **Cancel** button in the **Found New Hardware Wizard** dialog box. In this case, the driver of the video capture card is installed automatically during the *INTELLECT™* software installation.

If *INTELLECT™* has already been installed and a new video capture card needs to be installed, then install the driver of the video capture card(s) using the **Found New Hardware Wizard** application (see [Installing drivers for video capture cards](#) section).

Installation of video capture cards is completed.

Installing drivers for video capture cards

When the video capture card is installed in the computer, the monitor displays the **Found New Hardware** message while the operating system is loading.



As a result the monitor automatically displays the **Found New Hardware Wizard** dialog box.



Note
If *INTELLECT™* is to be installed on the given computer, then click the **Cancel** button in the **Found New Hardware Wizard** dialog box. In this case, the driver of the video capture card is installed automatically during the *INTELLECT™* software installation.

If *INTELLECT™* has already been installed and a new video capture card needs to be installed or a driver needs to be reinstalled, do the following:

Attention!
It is recommended to shutdown antivirus software while installing the driver

1. Select **No, not this time** and click **Next** in the **Found New Hardware Wizard** dialog box.
2. Select one of the following actions:
 - a. Install the software automatically (recommended) – driver search and follow-up installation.
 - b. Install from a list or specific location – enables selecting the necessary driver or a folder for manual driver search.If the **Install the software automatically (recommended)** item is selected, then the description of installation continues with item 6.
3. Select **Install from a list or specific location** and click **Next**.

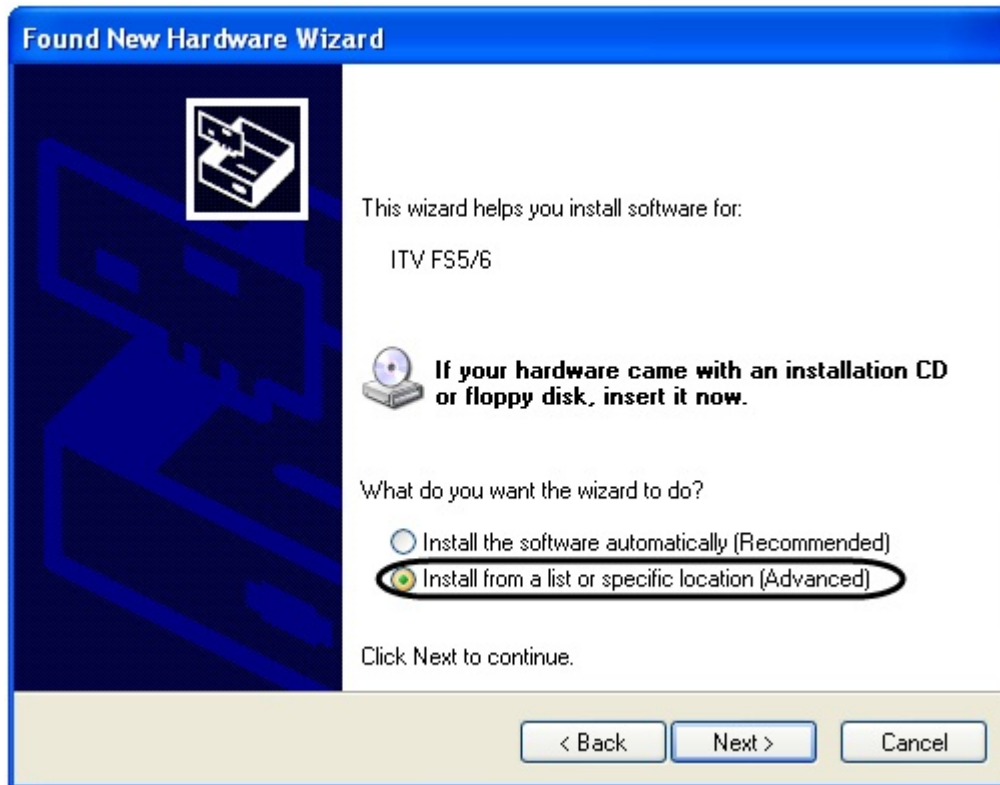

4. Set the **Include this location in the search** checkbox in the search options dialog box and click the **Browse** button. In the **Browse For Folders** box specify the path to the folder that contains drivers for a video capture card and click **OK**.

Note

Drivers for video capture cards are stored in the **Drivers** folder on the installation CD or in the *INTELLECT™* software installation directory. To install drivers for video capture cards select the folder, where the drivers for video capture cards are stored (see [Drivers for video capture cards integrated into the *INTELLECT™* software](#) section).

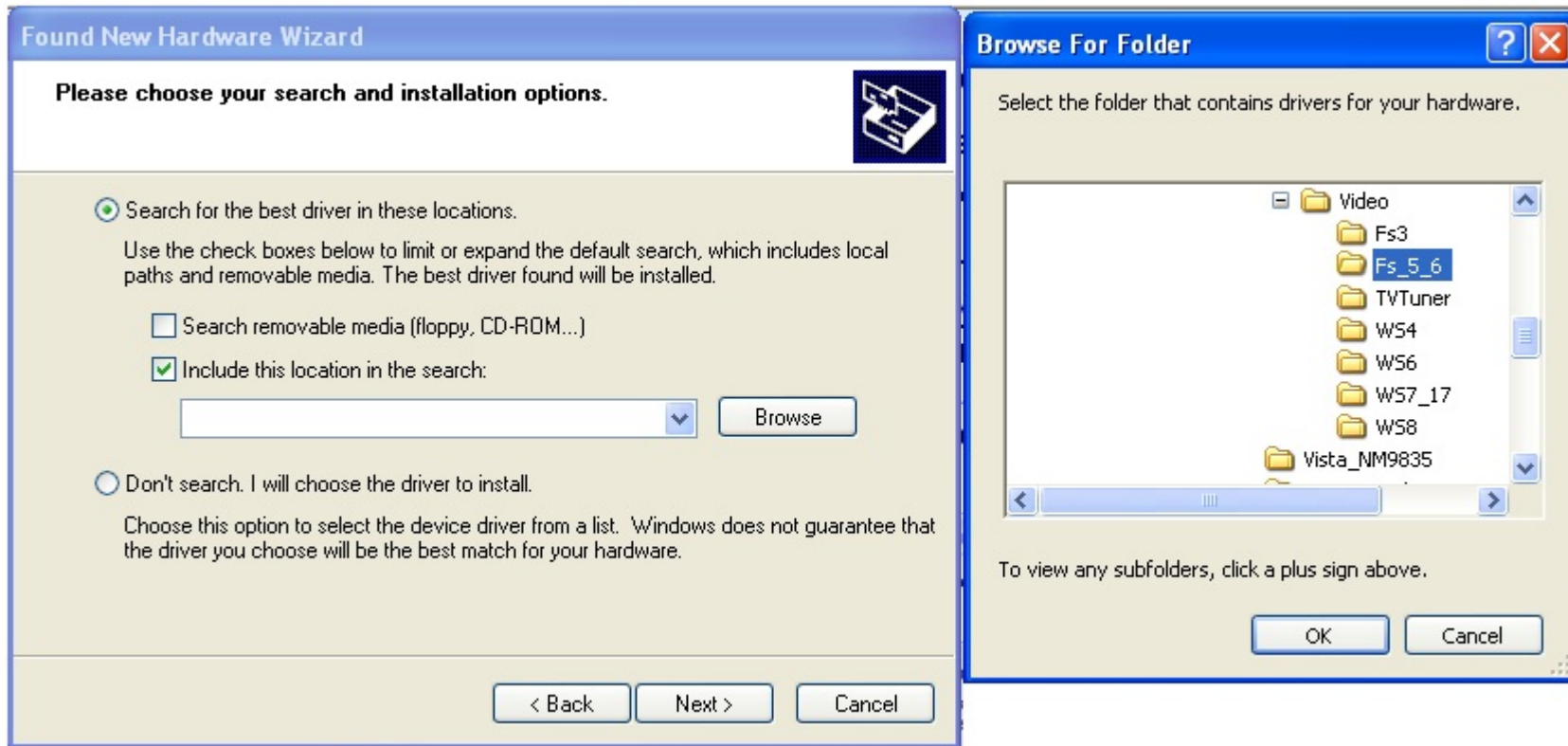

5. After specifying the path to the folder click the **Next** button in order to start installation process.

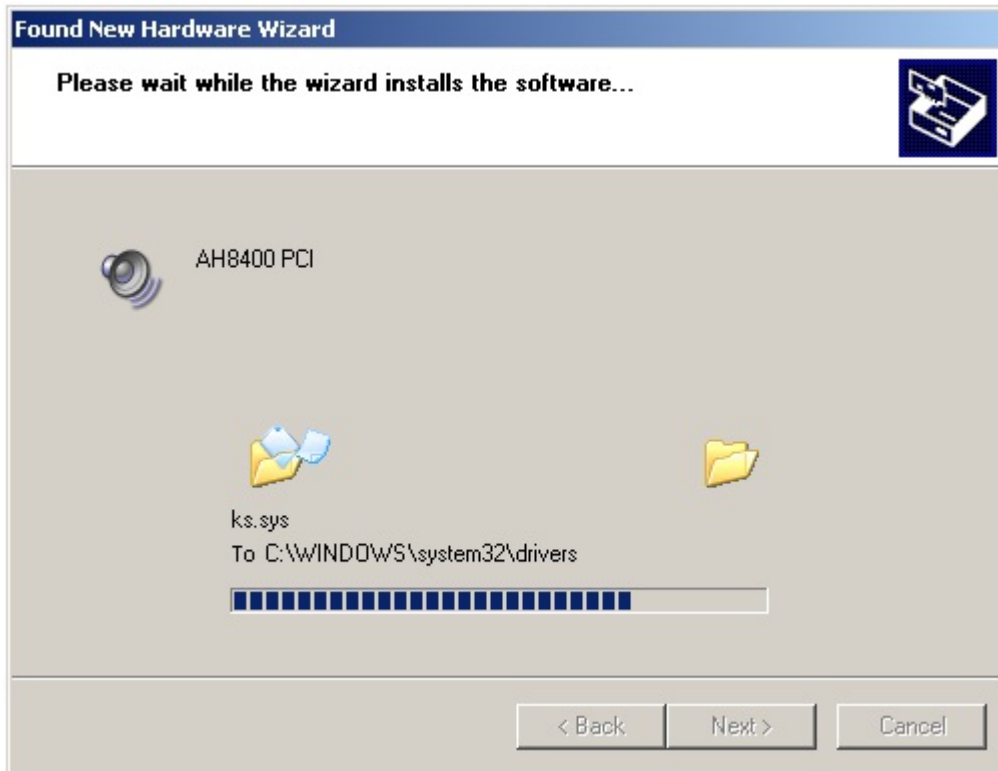

6. Ignore Microsoft notification by clicking the **Continue Anyway** button.



7. To complete installation click the Finish button.



As a result the message **Your new hardware is installed and ready to use** is displayed in the Windows taskbar.

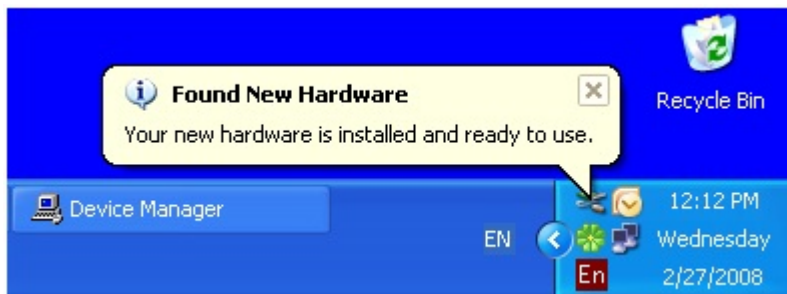

Installation of a driver for video capture card is completed.

Driver installation procedure for one video capture card is repeated in turn required number of times depending on the number of ADCs on the video capture card (e.g., 1 time for FS-5 video capture card, 4 times for FS-6, FS-16, WS-7 video capture cards, 8 times for FS-8 video capture card).

Testing installation of drivers for video capture cards

When installation of the drivers for video capture cards is finished, driver availability in the Windows operating system should be tested with the help of the Device Manager. For this do the following:

1. Open the **System Properties** window by right-clicking the **Computer** icon on the desktop and select **Properties** in the contextual menu.

Note
The **System Properties** window can be opened by clicking **Start=> Control Panel=> System**.



2. In the **System properties** dialog box go to the **Hardware** tab and click the **Device Manager** button.

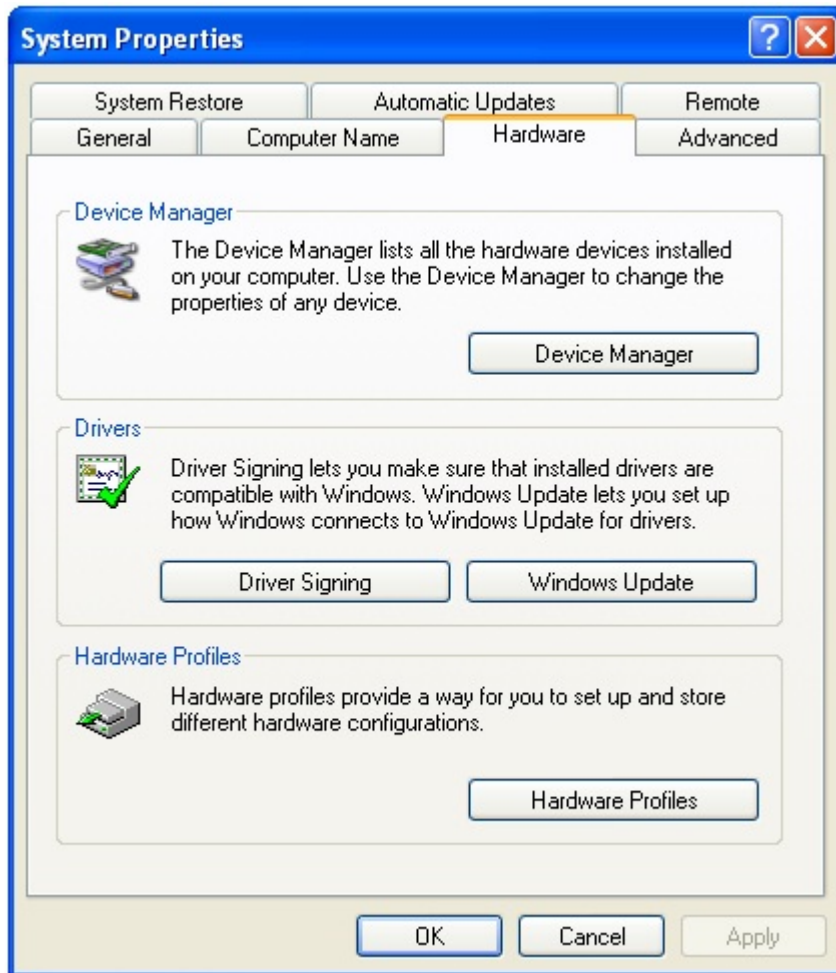

3. Go to **Sound, video and game controllers** item in the Windows hardware tree and check if the displayed list of devices agrees with the types of installed video capture cards.

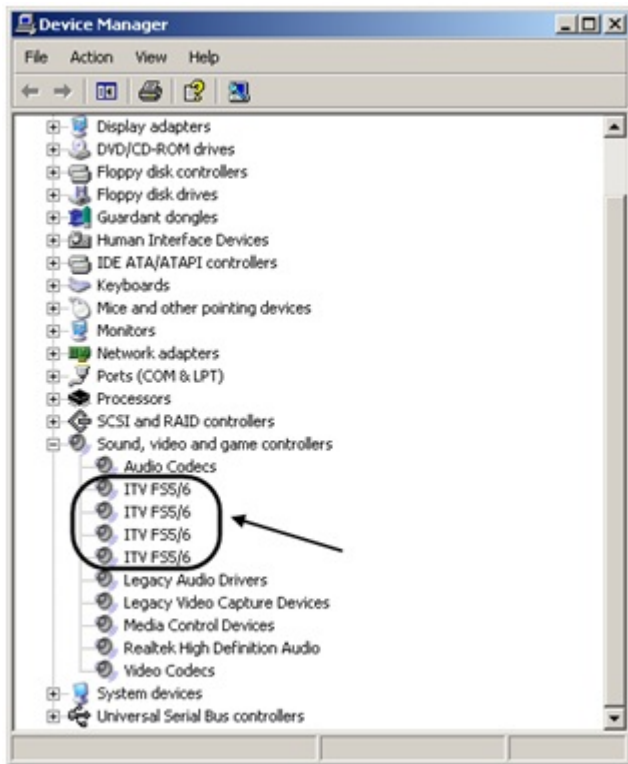

Testing installation of drivers for video capture cards using the Codereader.exe utility

To test installation of drivers for video capture cards use the Codereader.exe utility designed to read the codes of video capture cards. It is bundled with the *INTELLECT™* software.



Note

Some video capture cards (e.g., FX116, FX416 and MS416) are not equipped with a cryptochip. It is impossible to test installation of drivers for these video capture cards using the Codereader.exe utility.

The utility is run from the **Tools** folder of the *INTELLECT™* software installation package. E.g., C:\Program Files\Intellect\Tools\codereader.exe.

The Codereader.exe utility can also be run by selecting **Start All Programs INTELLECT Utilities Code Reader**.

As soon as the utility is run, the monitor displays a window with the codes of video capture cards.

If the drivers for video capture cards are installed correctly, the utility window will display the codes of video capture cards. If there are several embedded ADCs in the video capture card, then the codes will be repeated as many times as there are ADCs in the video capture card.

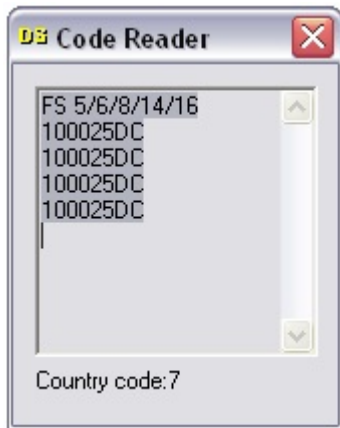

If the Codereader.exe window does not display any code or displays it as "0000", it means that:

1. A video capture card is not installed in the computer.
2. A video capture card is defective.
3. A driver for a video capture card is not installed.
4. Installed driver does not correspond to a video capture card in use.
5. Installed driver for a video capture card fails to perform.
6. A video capture card has no cryptochip (FX116/FX416/MS416).

Check if the video capture card is installed in the computer and re-install drivers for all ADCs of the video capture card. If after re-installation ADC codes still cannot be read by the Codereader.exe utility, then contact your distributor to check the video capture card.

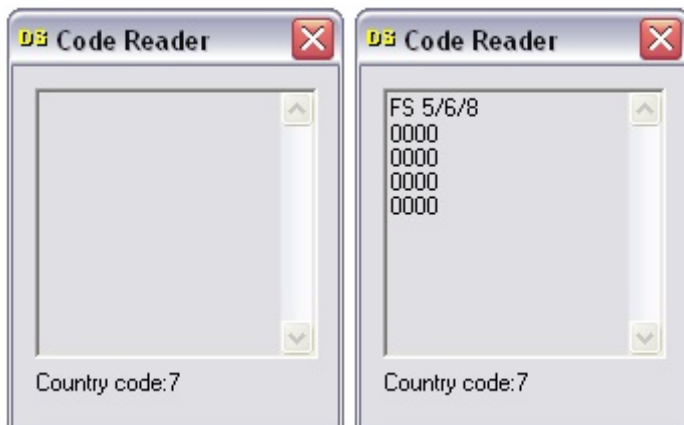

Characteristics of Driver Pack updating for YUAN cards

The following video capture devices are qualified as YUAN cards: SC390N16 (WS16), SC3B0N16 (WS216), SC200Q4 (FS15), SC300Q16 (FX4), SC300D16 (FX8), SC310N16 (FX16), SC200Q4 Low profile (FS115), SC510N4 (FX HD4), SC330Q16 (analogue of SC300Q16) and SC330D16 (analogue of SC300D16).

For these cards updating from DriversPack 3.2.21 and lower to version 3.2.22 and above is performed as follows:

1. Remove installed DriversPack and install a new version or update the installed Driverspack.
2. Repair the Intellect software package (see the [Repairing INTELLECT™ software](#) section in *Administrator's Guide*).

Attention!

The repairing utility is to be run using the login of computer Administrator.

3. Check whether the drivers for video capture card are installed (see the [Testing installation of drivers for video capture cards](#) section).
4. Install the driver if it was not installed (see the [Installing drivers for video capture cards](#) section).

Note.

The YUAN card will not be found by the *Camera discovery tool* after performing actions which are described above. in this case configure video subsystem manually (see the [Video subsystem configuration](#) section).

The card will be found by the *Camera discovery tool* if you install DriversPack and then install the *Intellect* software package.

Installing the expansion card for analog video out

There is a special option for viewing video sequences from surveillance cameras with the analog monitors – analog video out. To activate this option with FS-5, FS-6 and FS-16 video capture cards, the additional card is used – analog video out card.

The analog video out card is used for direct video signal output from one of the cameras connected to the Server to the analog monitor (with no digitization).

The analog video out card has three connectors compatible with FS-5, FS-6 and FS-16 video capture cards.

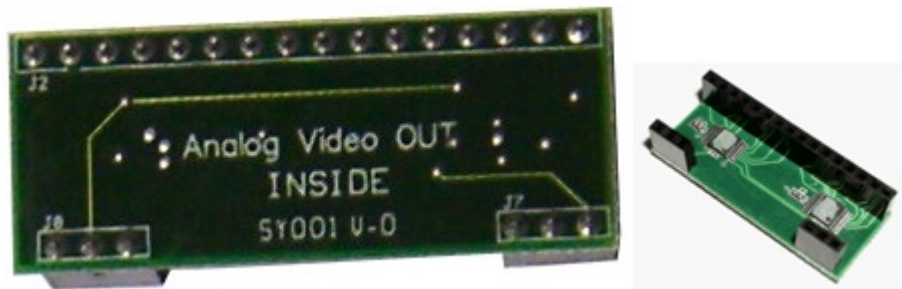

Install the analog video out card as follows:

1. Make sure that the video capture card power supply is off (either the computer with installed video capture card is off or the video capture card is not installed).
2. Install the analog video out card on the video capture card using special connectors on the video capture card.

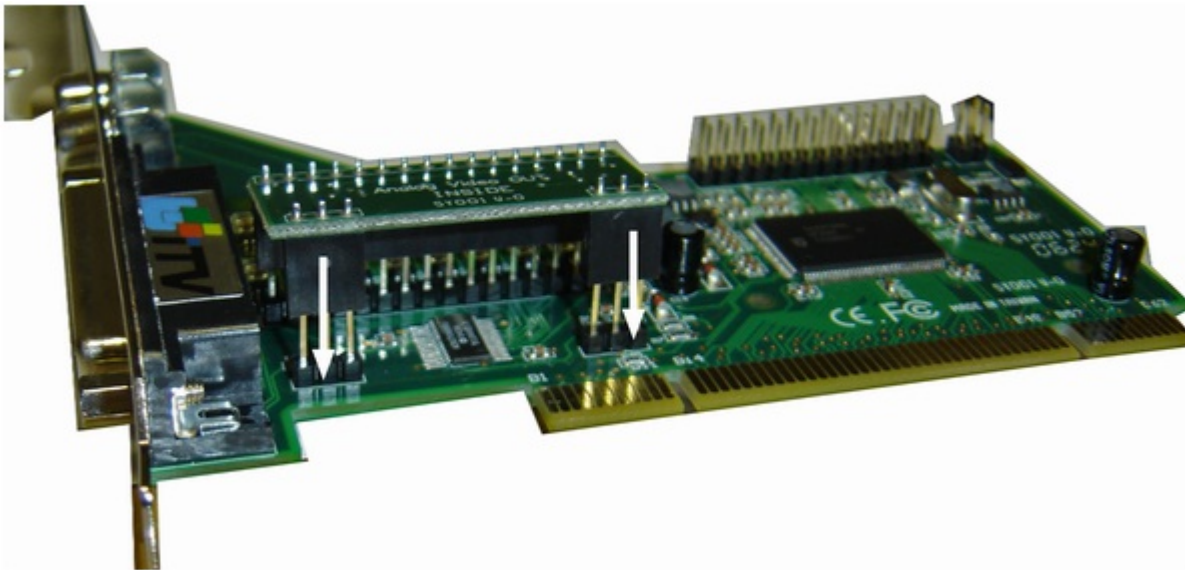
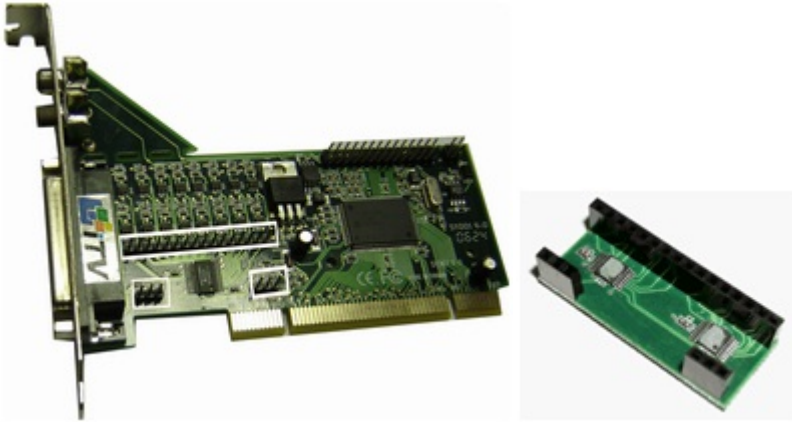

3. Connect the interface cable of the analog monitor to the red BNC connector of the video-in cable connected to the video capture card.

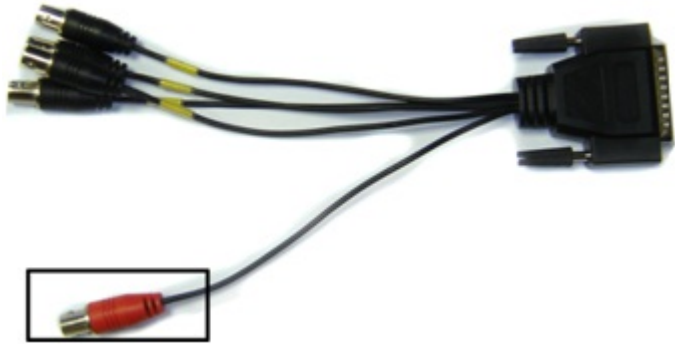

Connecting the hardware performance testing

Hardware performance tester is designed to automatically restart the computer whenever any failure in the Windows OS or basic modules of *INTELLECT™* software occurs.

Hardware performance testing is done in one of two ways:

1. With the help of Watchdog used on servers with installed video capture cards that support the Watchdog hardware testing (see [Appendix 4. Technical specifications of video capture cards](#)).
2. With the help of USB-Watchdog used on servers and clients without installed video capture cards.

Connecting the Watchdog hardware performance tester

In case of the Watchdog hardware performance testing the **Reset** button is connected to the computer motherboard via the video capture card with the help of special Watchdog cable.

Note
The Watchdog cable is optionally bundled with video capture card.

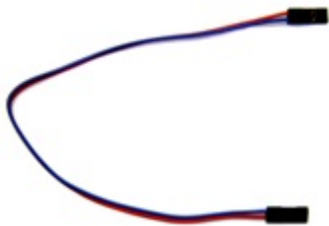

If several video capture cards are installed on the Server, then Watchdog is connected to one card only.

A special four-pin connector or two two-pin connectors are installed on the video capture card to connect the Watchdog cable.

A four-pin connector for connecting the hardware tester of Watchdog pending (by the example of FS-5 video capture card):

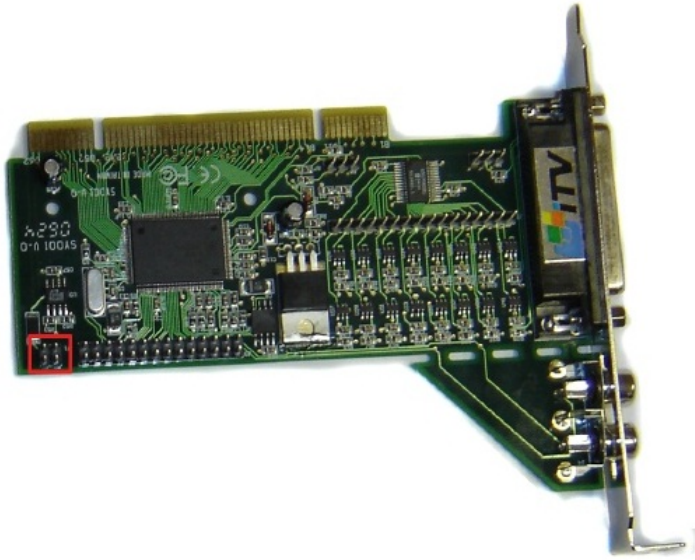

Two two-pin connectors for connecting the hardware tester of Watchdog pending (by the example of SC300Q16 (FX-4) video capture card):

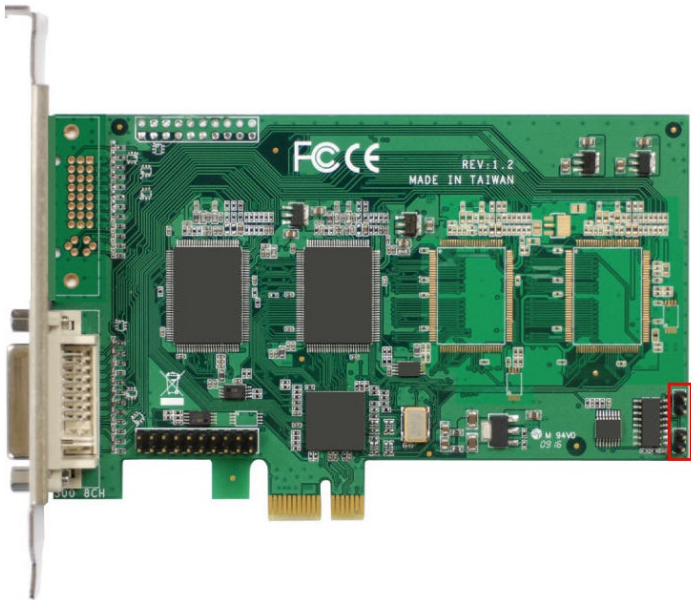

Connect the Watchdog hardware performance tester as follows:

1. Make sure that power of motherboard and video capture card is off.
2. Connect the cable of the **Reset** button to the two-pin or four-pin connector of video capture card with the help of a pair of 1/0 or 2/0 connections. Connection of the Reset button cable to FS-5 video capture card is displayed in the second figure.

Attention!

Cables are to be connected to the video capture card taking into account the positioning of the main wire of four-pin connector. You can connect the Watchdog cable to two-pin connector of FX video capture cards any way without taking into account the positioning of the main wire.

Note

To specify the positioning of the main wire (earth conditioned «-/-») the multimeter may be used in the resistance test mode. In this case the main wire is determined by 0 resistance value between contacts.

Appearance and pinout of four-pin connector of video capture card: 0/0-main wire (earth conditioned «-/-»), 1/0 and 2/0- pairs of contacts for cables connections («+/-», «+/-»):

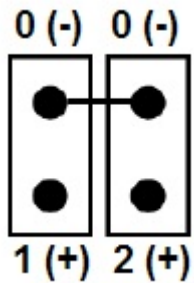

The **Reset** button cable connection to the four-pin connector of FS-5 video capture card:

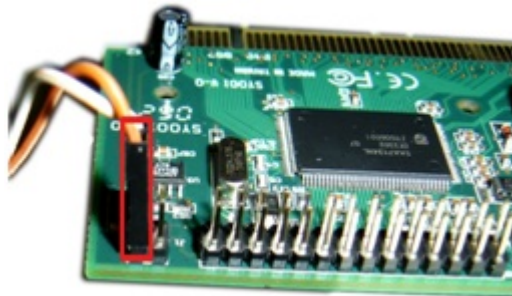

3. Connect the Watchdog cable to the vacant two-pin or four-pin connector of video capture card with the help of vacant pair of contacts (1/0 or 2/0) – see the figure above. The Watchdog cable connection to FS-5 video capture card is exemplified in the figure below:

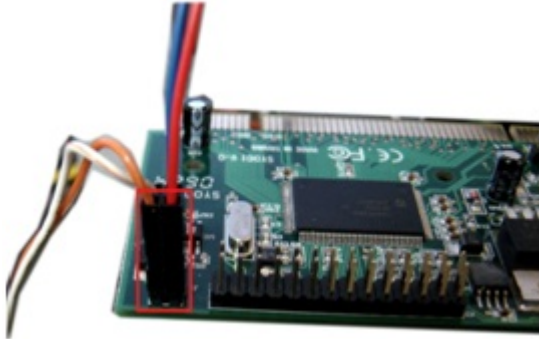

4. Connect the vacant end of the Watchdog cable to the connector on the motherboard for the **Reset** button cable.

Connecting the Watchdog hardware performance tester is completed.

Note
Connecting the Watchdog hardware performance tester is not correct if there is no reboot after pressing the **Reset** button.
If all the steps of connecting are correct, then the Watchdog inoperativeness can be caused by inobservance of polarity while connecting the Watchdog cable to the motherboard. Interchange the cables and reconnect the Watchdog cable to the motherboard.

Note
Program setting of the Watchdog function is necessary to activate the hardware performance tester (see [Configuring the Watchdog hardware performance tester](#) section).

Connecting the USB Watchdog hardware performance tester

In case of the USB Watchdog hardware performance testing the **Reset** button is connected to the computer motherboard via the USB Watchdog device with the help of special Watchdog cable. The appearance of the USB Watchdog device is displayed in the figure:

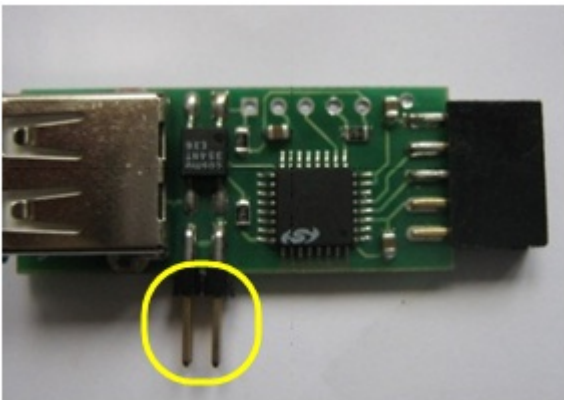

Special four-pin connector is installed on the USB Watchdog device to connect the Watchdog cable.

Connect the USB Watchdog hardware performance tester as follows:

1. Make sure that power of motherboard and video capture card is off.
2. Connect the USB Watchdog device to USB connector on the motherboard.

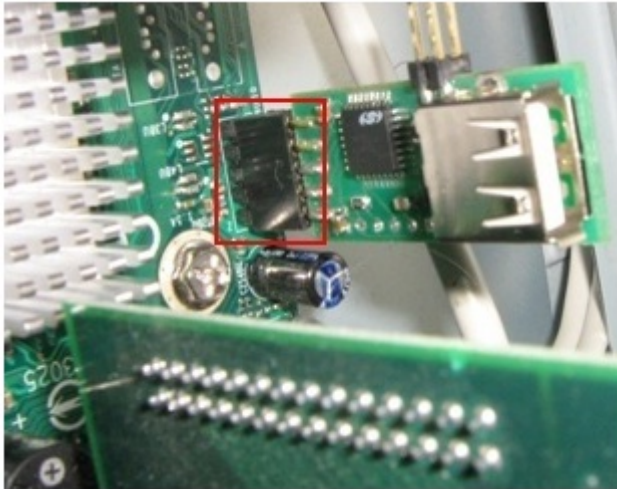

3. Connect the **Reset** button cable to the four-pin connector of the USB Watchdog device with the help of a pair of contacts (1/0 or 2/0). Connecting the **Reset** button cable to the USB Watchdog device is exemplified in the figure.

Attention!

Cables are to be connected to the video capture card taking into account the positioning of the main wire of four-pin connector.

Note

To specify the positioning of the main wire (earth conditioned «-/-») the multimeter may be used in the resistance test mode. In this case the main wire is determined by 0 resistance value between contacts

Appearance and pinout of four-pin connector of the USB Watchdog: 0/0-main wire (earth conditioned «-/-»), 1/0 and 2/0- pairs of contacts for cables connections («+/-», «+/-»):

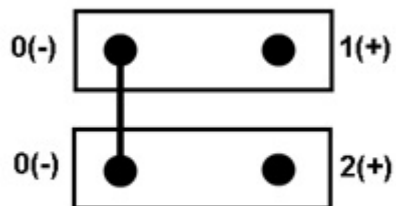

Connection of the cables to four-pin connector of the USB Watchdog device.



4. Connect the Watchdog cable to four-pin connector of the USB Watchdog device with the help of a vacant pair of contacts (1/0, or 2/0) – see the figure above.
5. Connect the vacant end of the Watchdog cable to the connector on the motherboard for the **Reset** button cable.

Connecting the USB Watchdog hardware performance tester is completed.

⚠ Attention!

The USB Watchdog hardware performance tester is activated with the help of the System restart service (see [Activating the hardware control of workability](#) section in [Administrator's Guide](#)).

ℹ Note

Connecting the USB Watchdog hardware performance tester is not correct if there is no reboot after pressing the **Reset** button.

If all the steps of connecting are correct, then the USB Watchdog inoperativeness can be caused by inobservance of polarity while connecting the Watchdog cable to the motherboard. Interchange the cables and reconnect the Watchdog cable to the mother board.

Note
 USB connector on the USB Watchdog may be used for connecting any external USB devices to the computer. Connected USB devices do not influence the USB Watchdog hardware performance tester.

Connecting Sensor-Relay cards

DI/DO card is connected to the video capture card and is used for connecting guard loops (sensors) and relays to the control system - the server with installed *INTELLECT™* software. General information about sensors and relays is given in the table:

Type of device	Description	Functions	Operation conditions	Changes in operation condition	Examples of devices
Sensor	Interface line of external sensor and control system	Informs the control system about changes in sensor status	Closed- logical one Open - logical zero	Opening/closing - when sensor detects the alarm	Annunciators (smoke, heat, window, etc), button
Relay	Interface line of control system and executive device	Changes operation condition of executive device on command from the control system	Closed - logical one Open - logical zero	Opening/closing - on command from the control system.	Annunciators (light, sound, etc.), mechanized gates

Electrical and technical specifications of Sensor-Relay cards are given in [Appendix 6. Electrical and technical specifications of Sensor-Relay cards](#) section.

Connecting 4/4 and 16/4 Sensor-Relay cards

Multichannel digital-to-analogue conversion 4/4 and 16/4 Sensor-Relay cards can be installed on the Server depending on the security system requirements:

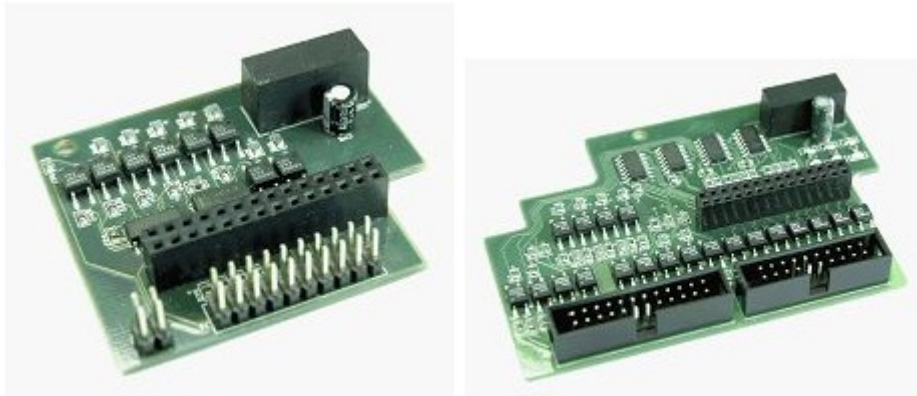

The 4/4 Sensor-Relay cards enable to process the signals from 4 sensors and the 16/4 cards - from 16 sensors. Simultaneously with processing the sensors signals these cards perform digital-analogue conversion and transmit up to 4 control signals to executive devices (relays).

The 4/4 and 16/4 Sensor-Relay cards have power (24V) and grounding terminals and are installed on FS-5, FS-6, FS-16 and FS-8 video capture cards.

Connect Sensor-Relay cards as follows:

1. Make sure that power supply of the video capture card is off.
2. Install the Sensor-Relay card on the video capture card with the help of special connectors.

Connector on the Sensor-Relay card for connecting to the video capture card (by the example of 4/4 and 16/4 Sensor-Relay cards):

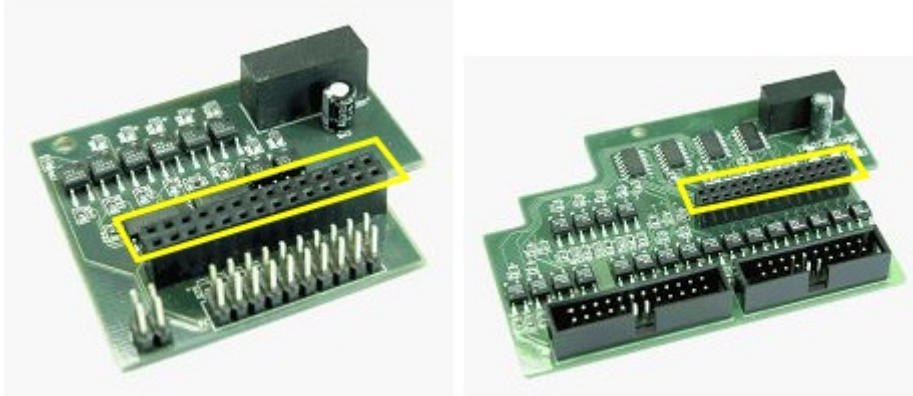

Connector on the video capture card for connecting the Sensor-Relay card (by the example of FS6 video capture card):



Installation of the Sensor-Relay card on the video capture card (by the example of 4/4 and 16/4 Sensor-Relay cards and FS6 video capture card):

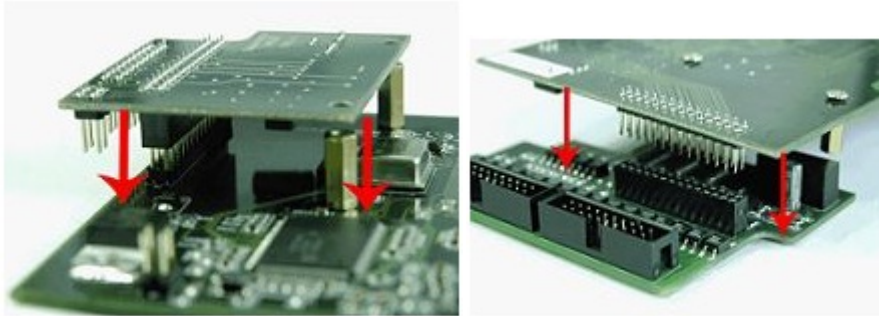

3. Fix the Sensor-Relay card on the video capture card with the help of screws bundled with the distribution kit of the Sensor-Relay card.
4. Connect the interface cable (bundled with the distribution kit of the Sensor-Relay card) to the Sensor-Relay card with the help of special connector:



Note

For interface cable connection the 4/4 Sensor-Relay card has J6 connector, 16/4 Sensor-Relay card has J6 and J7 connectors.



Attention!

The first wire of the interface cable (marked red) is to match the first pin of corresponding connector of the Sensor-Relay card.

Sensor-Relay interface cable:

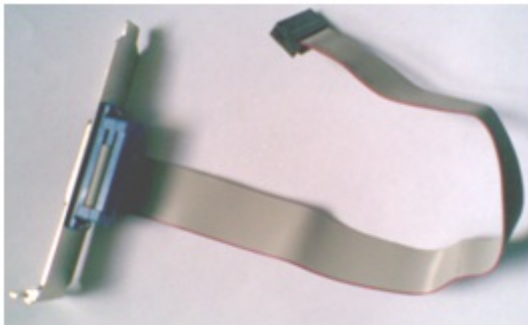

Connectors on the Sensor-Relay card for the interface cable connection (by the example of 4/4 and 16/4 Sensor-Relay cards):

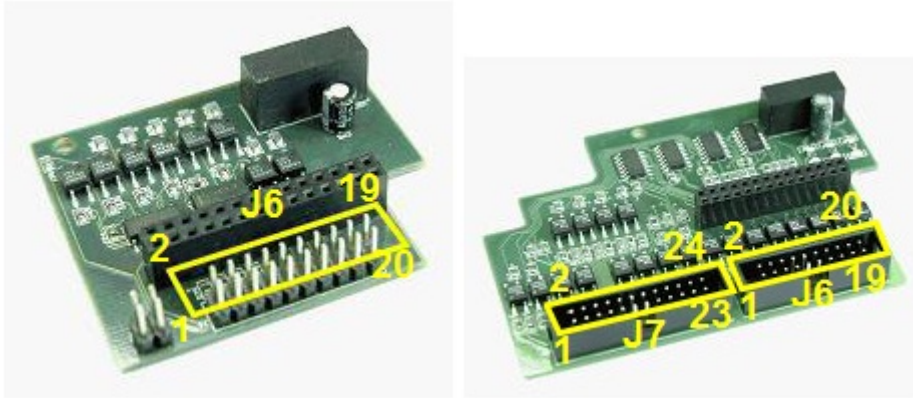

J6 and J7 connector pinout:

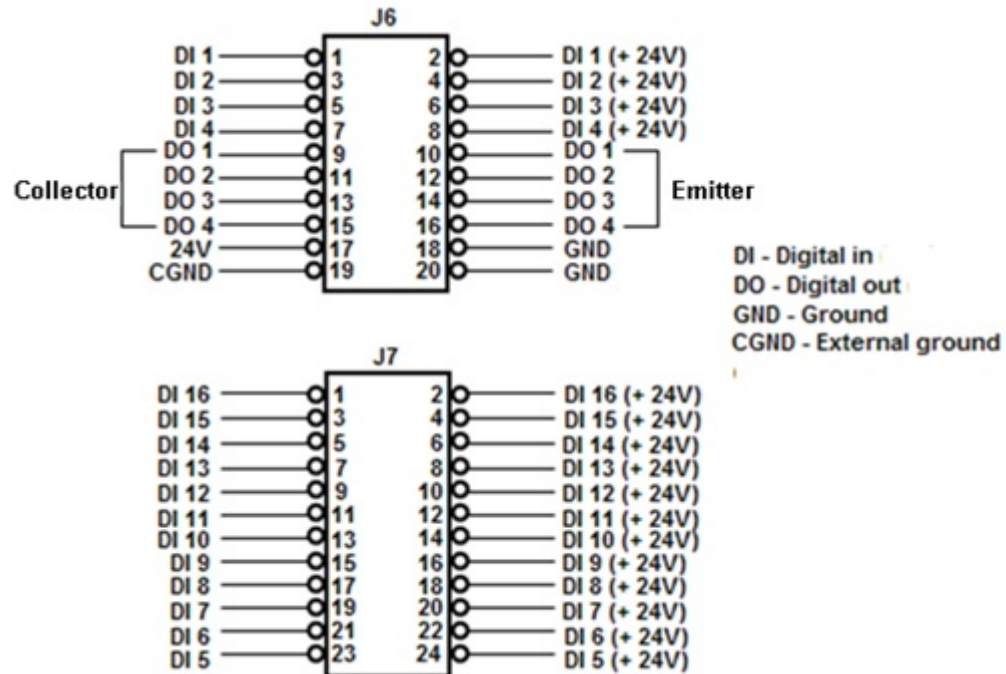

Example of the interface cable connection to the 4/4 Sensor-Relay card:



5. To connect Sensor-Relay, unsolder the connector bundled with the distribution kit of the Sensor-Relay card. Unsoldering is made in accordance with the external connector pinout of the Sensor-Relay interface cable, taking into account power circuit of connected devices.
 External connector pinout of the Sensor-Relay interface cable:

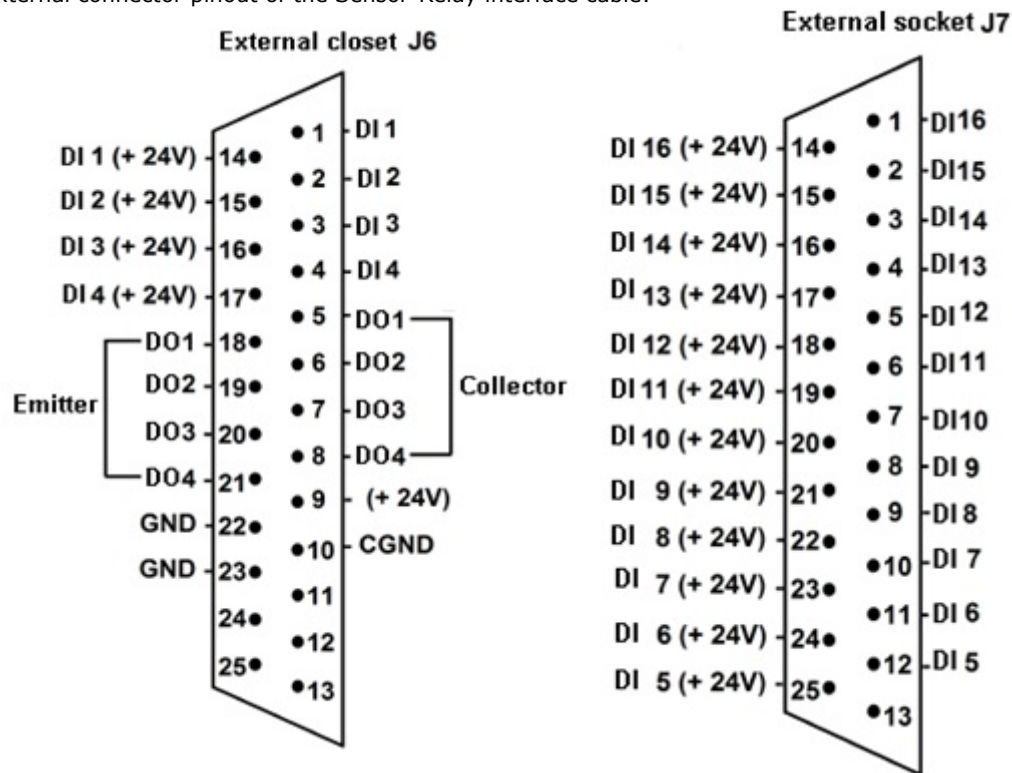

Sensor types and features of their connection:

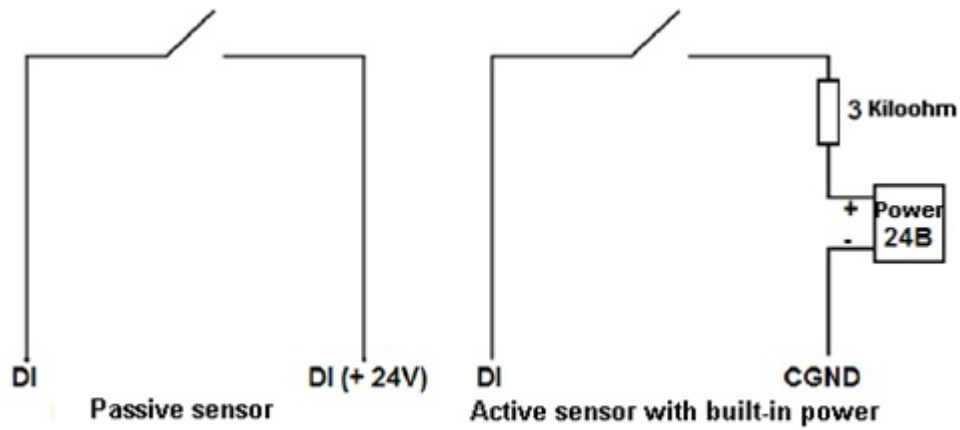

Example of power relay connection (with external power supply):

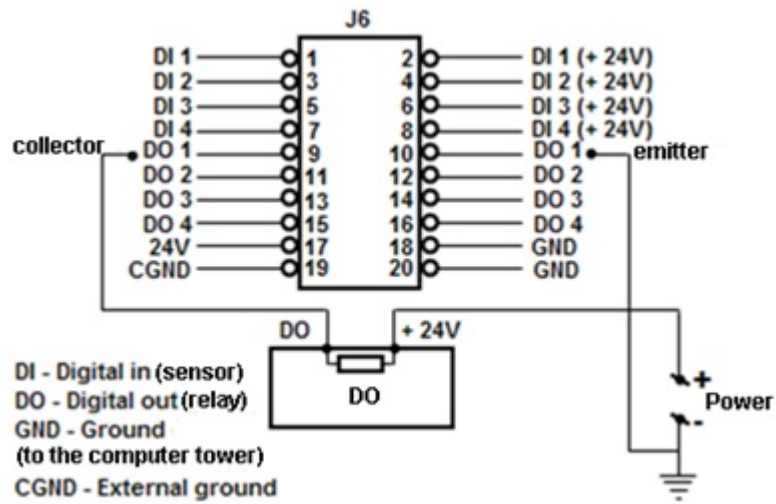

Example of low-power relay (power supply on the card):

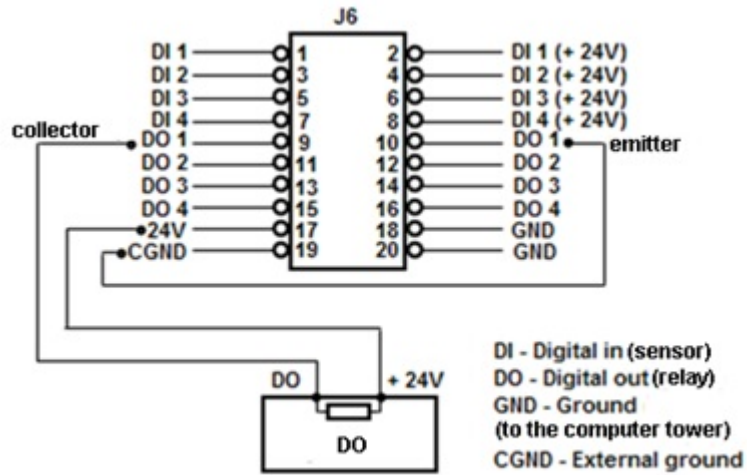

6. Fix the unsoldered connector in the casing bundled with the distribution kit of the Sensor-Relay card.
7. Connect ready-for-use connector to external connector of the Sensor-Relay interface cable in order to connect Sensor-Relay to the Server.

The Sensor-Relay cards are now connected.

Connecting 4/4 Sensor-Relay (low profile) cards

Building security video subsystem with the use of SC200Q4 Low profile (FS115) / SC300Q16 (FX4) / SC300D16 (FX8) / SC310N16 (FX16) / SC230N4 / SC3B0N16 (WS216) / SC590N4 video capture cards one can install 4/4 Sensor-Relay cards (low profile) in order to connect external sensors (DI) and executive devices (DO) to the Server.

4/4 Sensor-Relay (low profile) card appearance is shown in the figure:

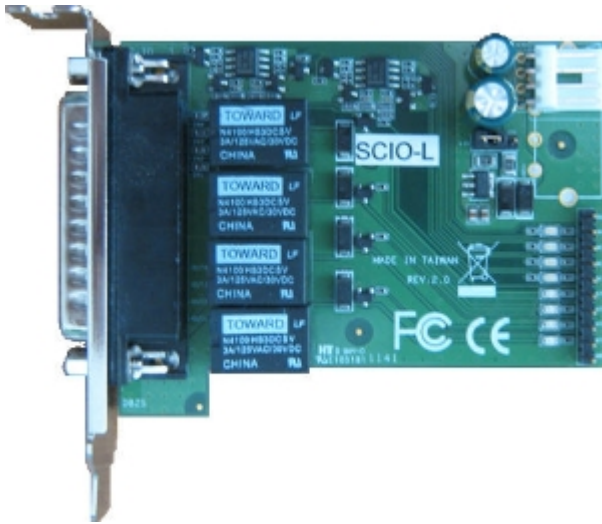

Connect the 4/4 Sensor-Relay (low profile) card as follows:

1. Make sure that the power of computer is off.
2. Connect the 4/4 Sensor-Relay (low profile) card to the video capture card with the help of loop bundled with the distribution kit. The loop is connected to J2 and J3 connectors (see the figures below and [Appendix 5. Video capture cards pins section](#)).

i Note

The loop is to be connected to the first row of J2 connectors. One of the outers is marked red in the figures.

The 4/4 Sensor-Relay card (low profile) can be connected to SC590N4 video capture card both to the first and the second row of J2 connectors.

The figure showing the 4/4 Sensor-Relay (low profile) card connection to SC200Q4 Low profile (FS115) card:

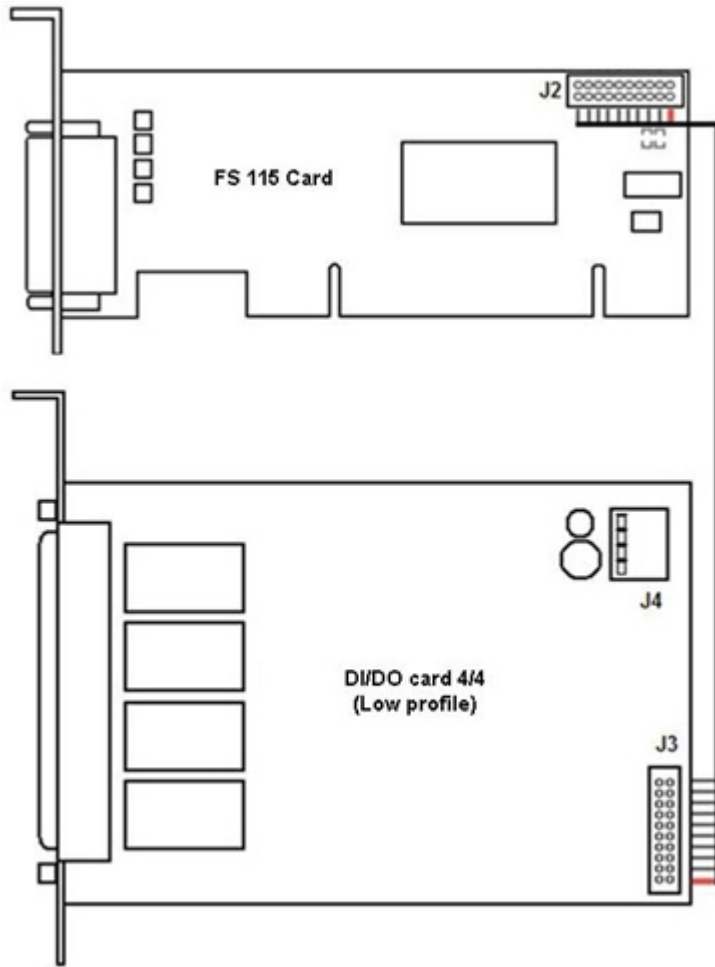

The figure showing the 4/4 Sensor-Relay (low profile) card connection to SC300Q16, SC300D16, SC310N16 (FX4/8/16) cards:

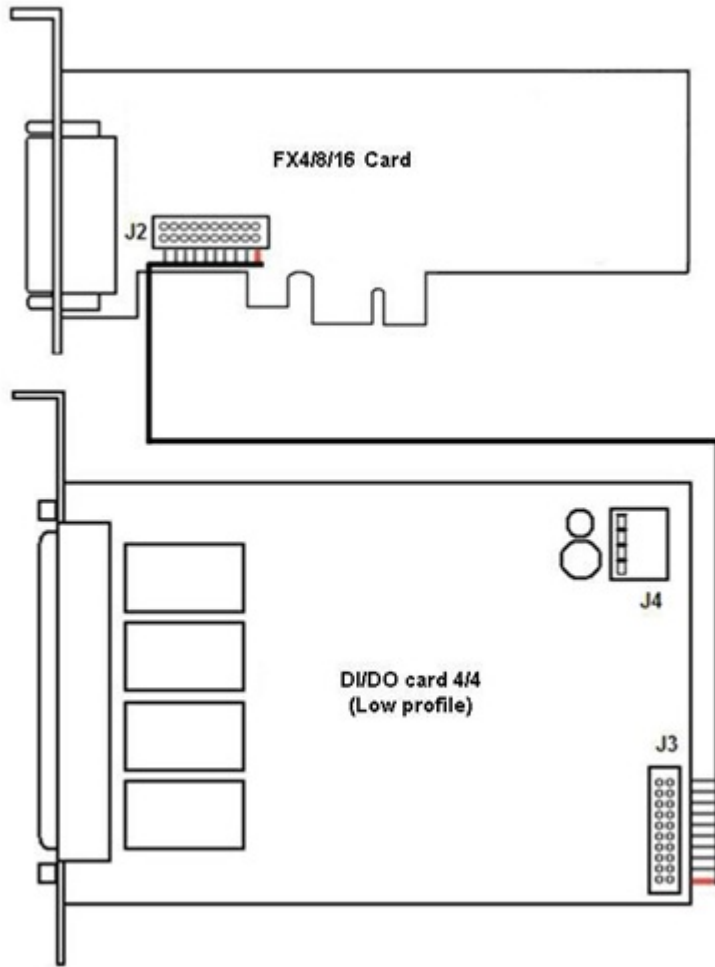

The figure showing the 4/4 Sensor-Relay (low profile) card connection to SC3B0N16 (WS216) card:

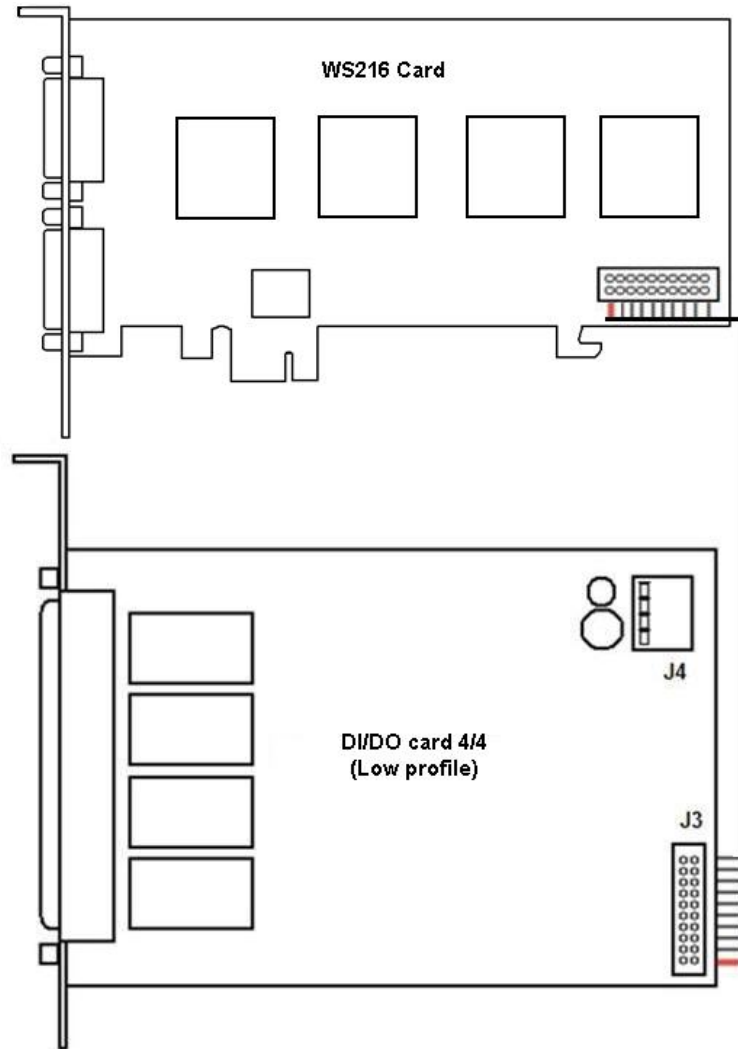

The figure showing the 4/4 Sensor-Relay (low profile) card connection to SC590N4 card:

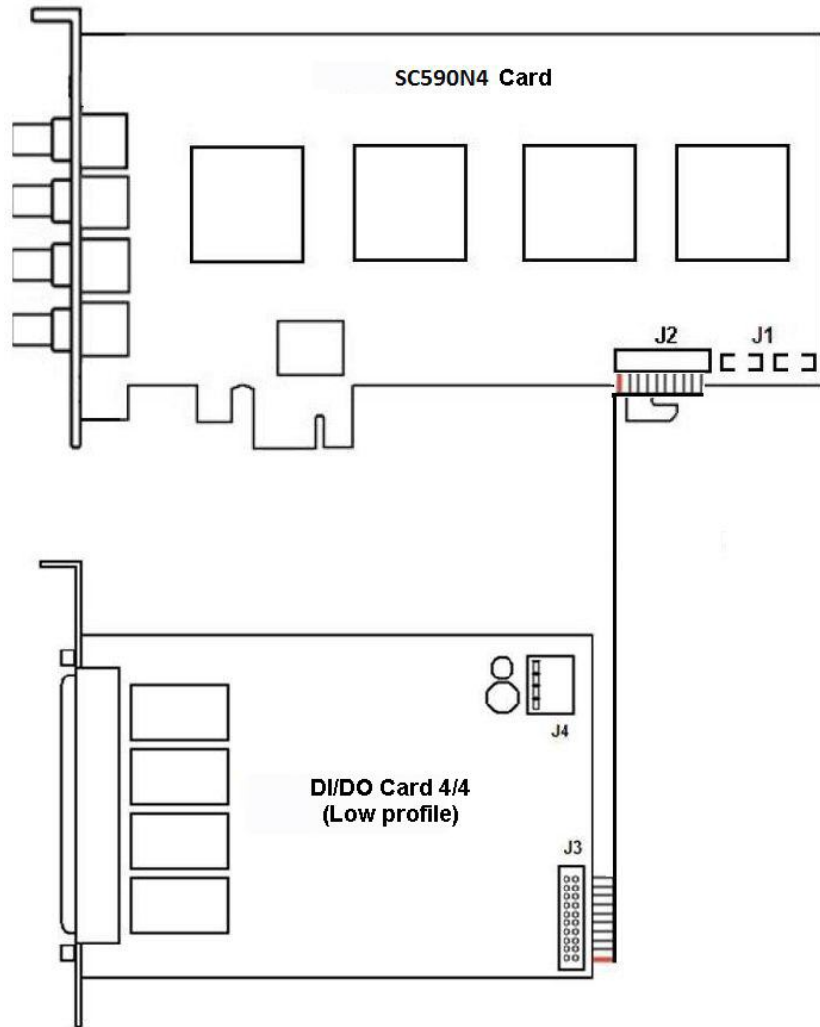

Note. SC590N4 card supports up to 8 sensors and 8 relays as two 4/4 Sensor-Relay (low profile) cards can be connected to the J2 connector simultaneously.

The figure showing the 4/4 Sensor-Relay (low profile) card connection to SC230N4 card:

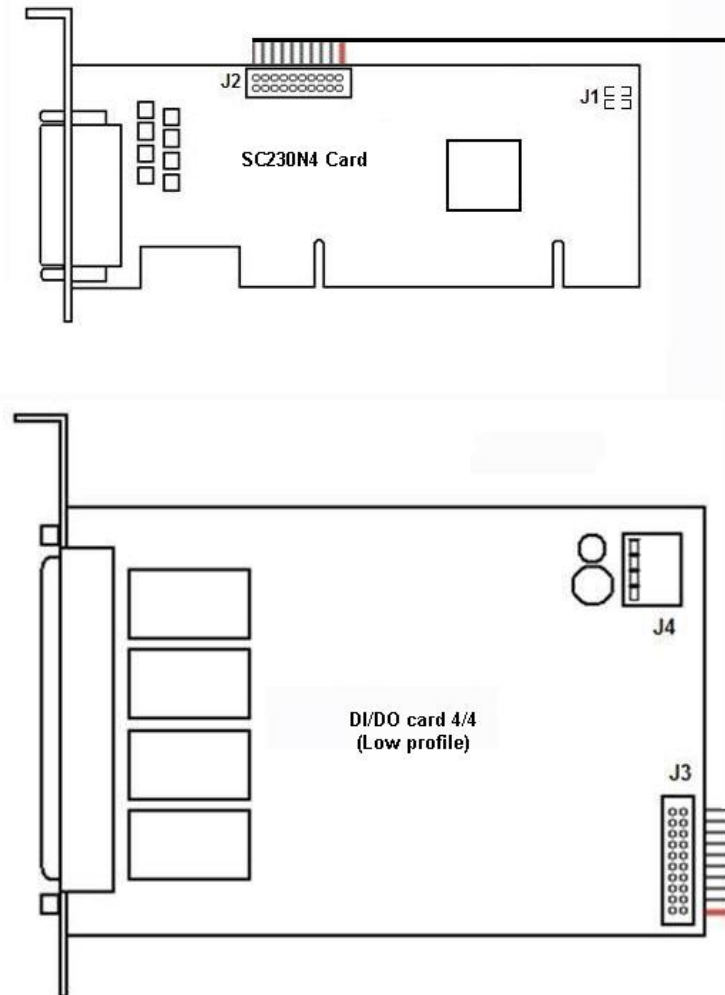

3. Connect the cable of computer PSU (disk drive power supply) to J4 connector of the 4/4 Sensor-Relay (low profile) card.
4. Install the card into vacant computer slot and fix it in the casing with the help of screw.
5. To connect Sensor-Relay, unsolder the connector. Unsoldering is made in accordance with the external connector pinout of the 4/4 Sensor-Relay (low profile) card.

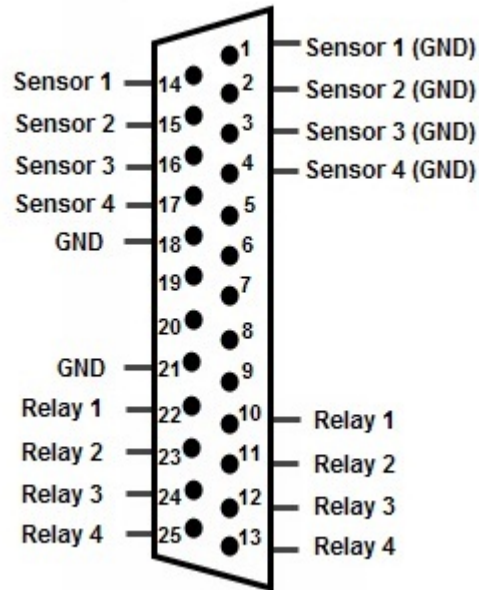

6. Connect the ready-for-use connector to external connector of the 4/4 Sensor-Relay (low profile) card in order to connect sensors and relays to the Server.

Attention!
 For 4/4 Sensor-Relay (low profile) card proper operation it is essentially required to supply video signal on at least one channel of the video capture card connected to the 4/4 Sensor-Relay (low profile) card.

The 4/4 Sensor-Relay (low profile) card is now connected.

Connecting SL USBIO (4x4, 16x8 and 24x4) cards

The SL USBIO card is an interface of external sensors and external executive devices (relays) as a part of video surveillance and fire and security alarm systems.

The figures show appearance of SL USBIO cards:

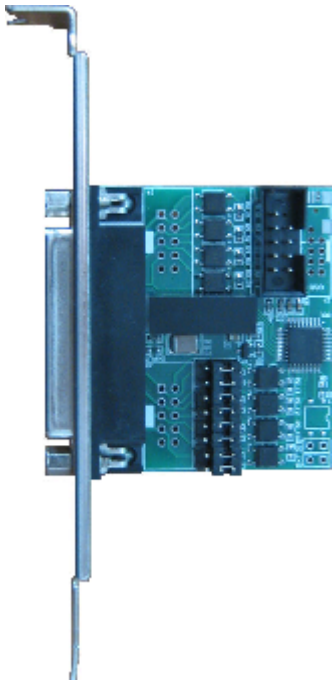

SL USBIO 4x4

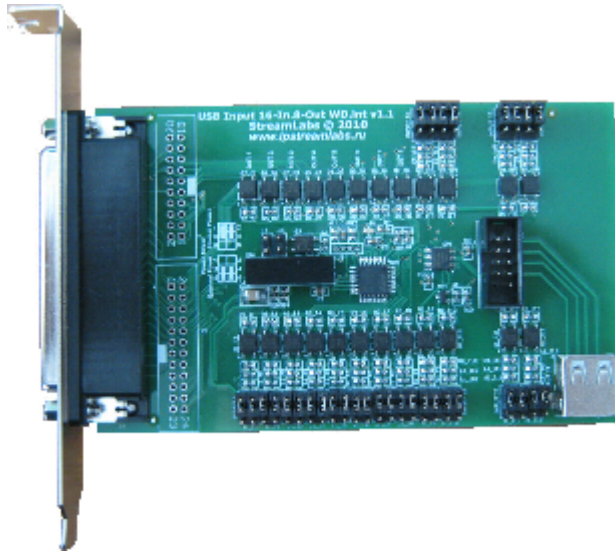

SL USBIO 16x8

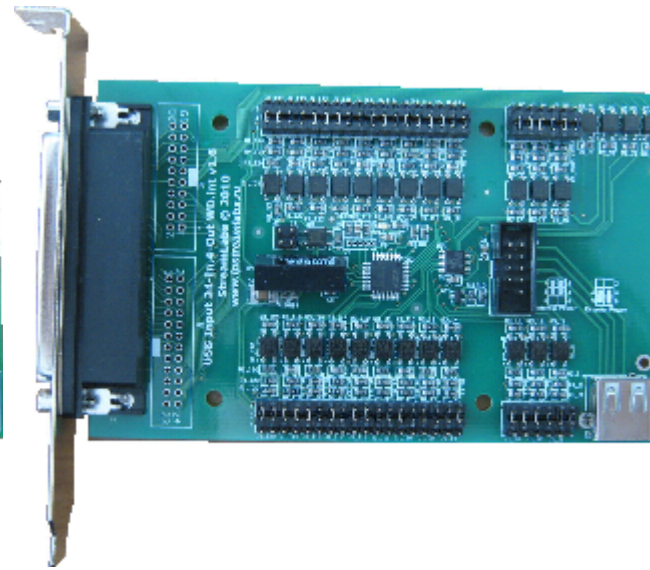

SL USBIO 24x4

The layout of SL USBIO connectors:

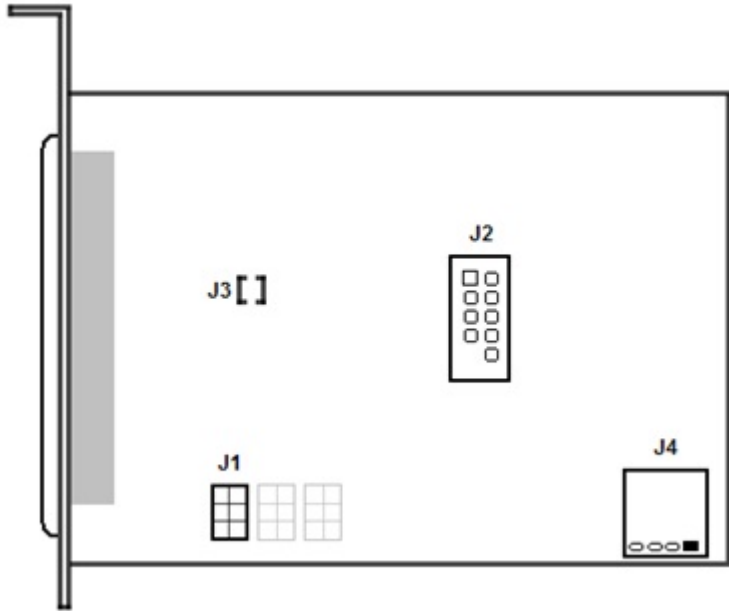

Connect the SL USBIO card to the Server as follows:

1. For each sensor configure the power supply by shifting the jumper in the corresponding **J1** contact set.

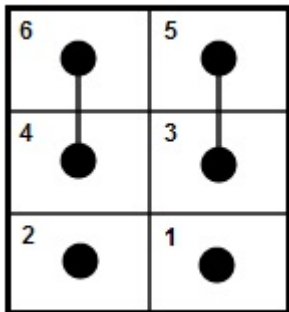

Sensor functions using the power supply in the device

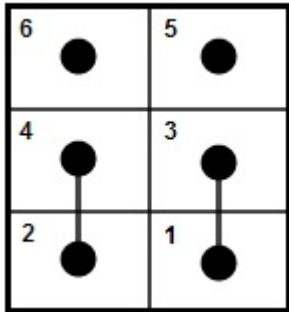

Sensor functions using the external power supply
(polarity of external voltage is not important)

2. Switch the computer power supply off. Remove the system cover.
3. Install the SL USBIO card into a vacant motherboard slot and fix it in the casing.
4. Connect the loop (bundled with the distribution kit) to the **J2** connector and to a vacant USB connector on the motherboard of computer.

Note

There is a special adapter in the delivery package if the SL USBIO 4x4 card is in use and the motherboard has an outsized USB connector or there is no connector for a loop contact. If you do not have the adapter, it is required to acquire one or route the loop leads by yourself taking into account the connector layout on the motherboard and USB connector layout on the SL USBIO 4x4 card (see the figure below):

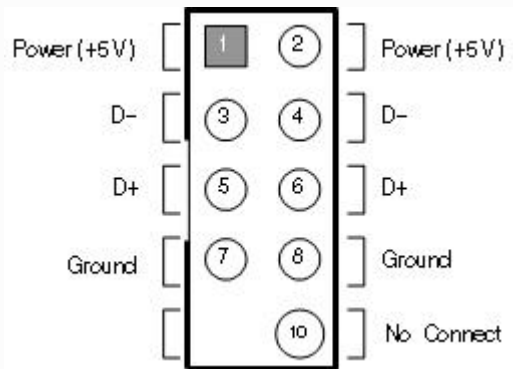

5. To activate the hardware pending check, connect wires to the **J3** connector (see [Connecting the hardware performance testing](#) section).

Note

There is no **J3** connector on the SL USBIO 4x4 card.

Use **J4** port if the connection is to be performed via the external USB port (USB cable of A-A type) or the USB device is to be connected.

Note

There is no **J4** port on the SL USBIO 4x4 card.

6. To connect sensors and relays, unsolder the connector and fix it in the casing bundled with the distribution kit. Unsoldering is made in accordance with the external connector layout (see Appendix 6. Electrical and technical specifications of Sensor-Relay cards).
7. Connect the ready-for-use connector to external connector of the SL USBIO card.

The SL USBIO card is now connected.

Connecting MO USBIO 4x4 cards

The MO USBIO 4x4 card is an interface of external sensors and external executive devices (relays) as a part of video surveillance and fire and security alarm systems.

The figure shows appearance of MO USBIO card.



Note

This card can be bundled as an external module – see the [Connecting MO USBIO 4x4 external module](#) section

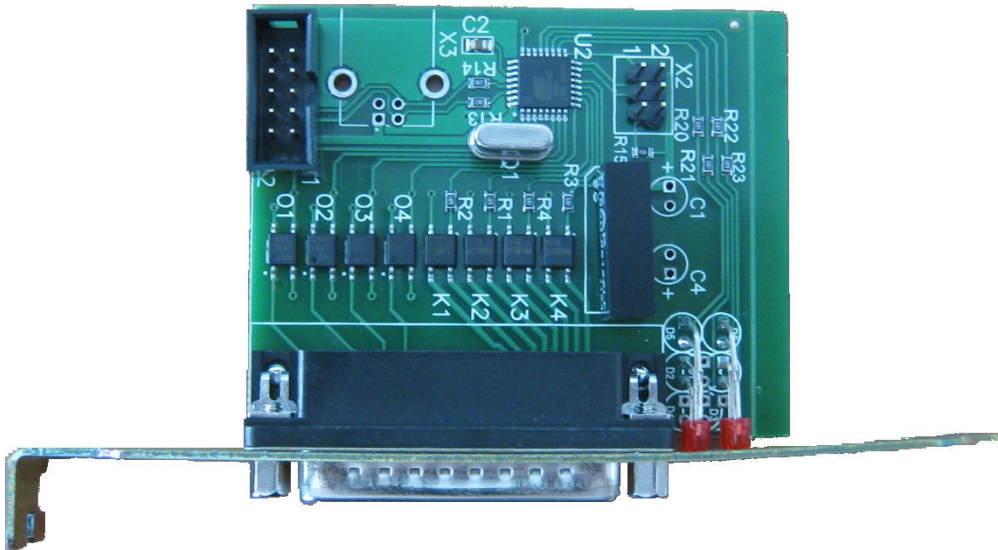

The layout of card connectors:

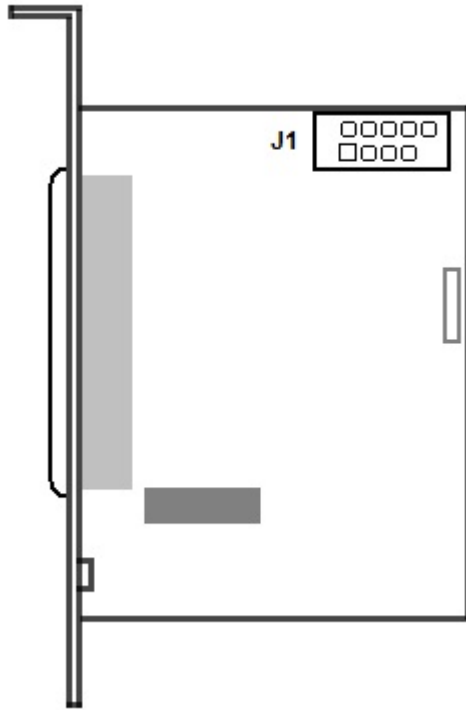

The device is controlled via the USB interface. Electrical and technical specifications of the card are given in the [Electrical and technical specifications of MO USBIO 4x4](#) section.

Connect the MO USBIO 4x4 card to the Server as follows:

1. Switch the computer power supply off. Remove the system cover.
2. Install the MO USBIO 4x4 card into a vacant motherboard slot and fix it in the casing.
3. Connect the loop (bundled with the distribution kit) to the **J1** connector and to a vacant USB connector on the motherboard of computer .
4. To connect sensors and relays unsolder the connector bundled with the distribution kit. Unsoldering is made in accordance with the external connector pinout of the MO USBIO 4x4 card.

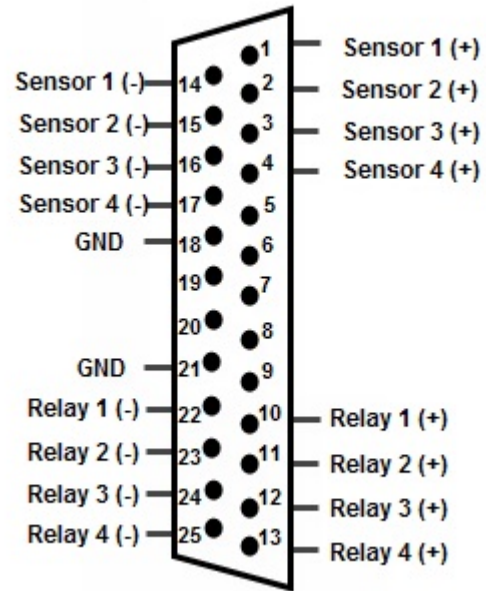

5. Fix the unsoldered connector in the casing bundled with the distribution kit.
6. Connect ready-for-use connector to external connector of the card in order to connect sensors and relays to the Server.

The MO USBIO 4x4 card is now connected.

Connecting Sensor-Relay (Stretch) cards

The figure shows appearance of the Stretch card series 6:

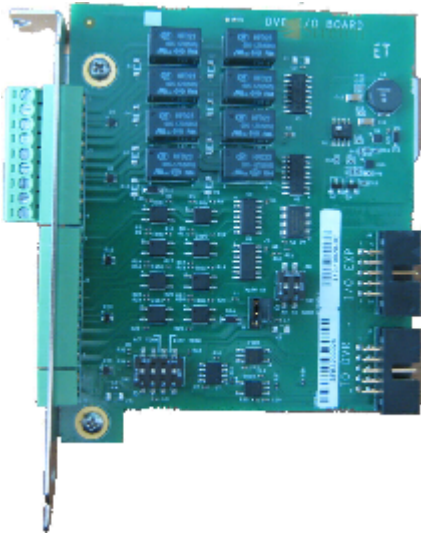

Connecting Sensor-Relay cards to Stretch (VRC6004, VRC6008, VRC6416) cards

Building security video subsystem with the use of Stretch (VRC6004, VRC6008, VRC6416) video capture cards one can install Sensor-Relay cards in order to connect external sensors and executive devices (relays) to the Server.

Connect Sensor-Relay card as follows:

1. Change the SW1 switch on the Sensor-Relay card in accordance with the table.

Sensor-Relay card	SW1 (1)	SW1 (2)
Sensor-Relay card 1	OFF	OFF
Sensor-Relay card 2	ON	OFF

2. If sensors need power supply (active sensors), then set the J6 jumper to 2 and 3 contacts, otherwise – to 1 and 2 contacts (passive sensors).



Note

The SW2 switch is used for the RS485 interface configuration.

3. Make sure that the power of computer is off.
4. Connect the Sensor-Relay card to the video capture card with the help of a loop bundled with the distribution kit. The loop is connected to the J1 and J2 connectors (see [Appendix 5. Video capture cards pins](#) section).

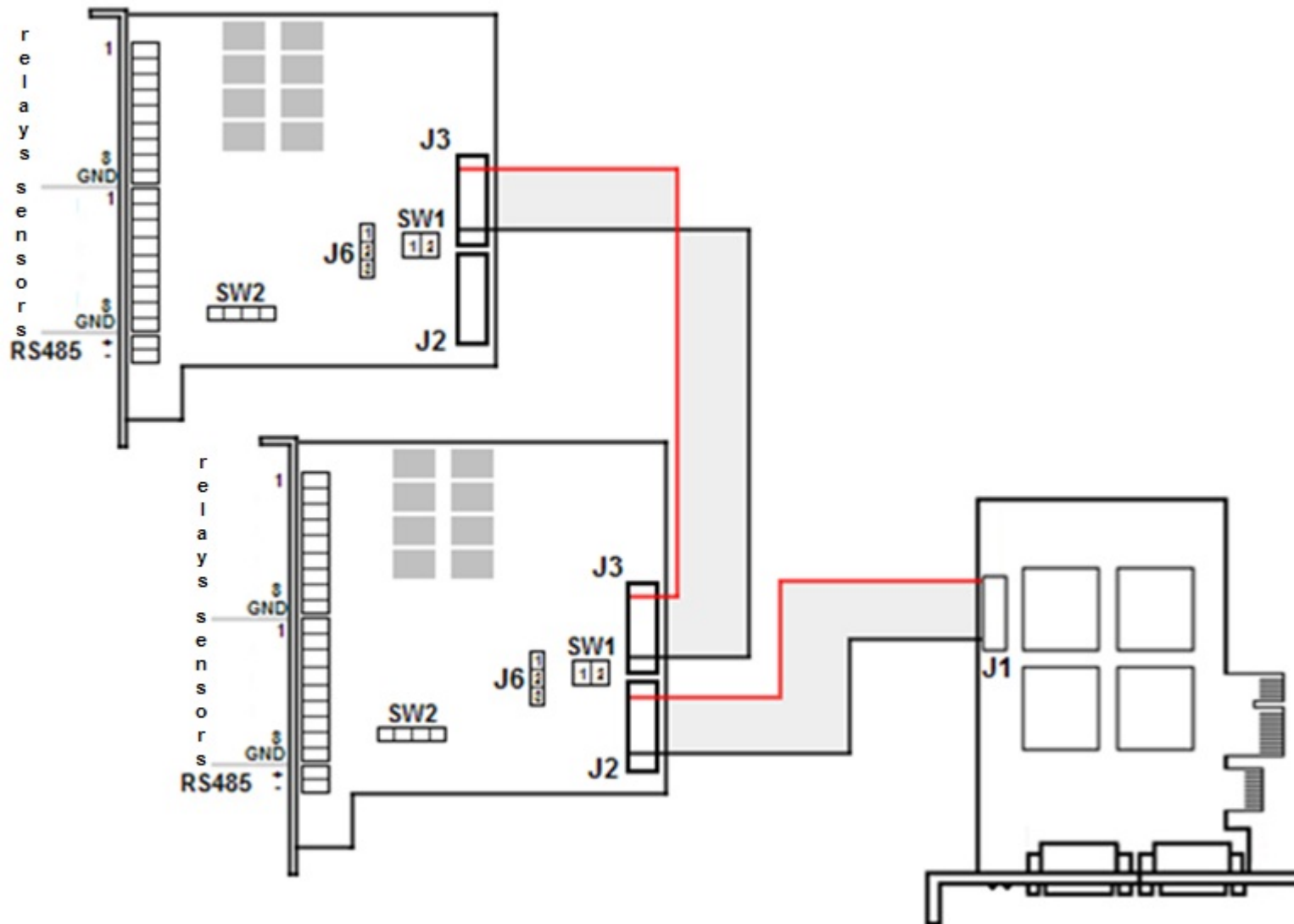

5. If it is necessary connect one more Sensor-Relay card. Connect the loop to the J3 connector on the first and second Sensor-Relay card.
6. Install the Sensor-Relay card into a vacant motherboard slot and fix it in the casing.
7. Connect sensors and relays in accordance with the pinout of external pin of the Sensor-Relay card.

Sensor-Relay card is now connected.

Connecting Sensor-Relay cards to Stretch VRC7008L card

Building security video subsystem with the use of Stratch VRC7008L video capture card one can install Sensor-Relay cards in order to connect external sensors and executive devices (relays) to the Server.

Connect the Sensor-Relay card as follows:

1. If sensors need power supply (active sensors), then set the SW1 jumper to 2 and 3 contacts, otherwise – to 1 and 2 contacts (passive sensors).

Note

The SW2 switch is used for the RS485 interface configuration. If two Sensor-Relay cards are in use, then the RS485 interface is disabled on the second card.

2. Make sure that the power of computer is off.
3. Connect the Sensor-Relay card to the video capture card with the help of a loop bundled with the distribution kit. The loop is connected to the J1 and J2 connectors.

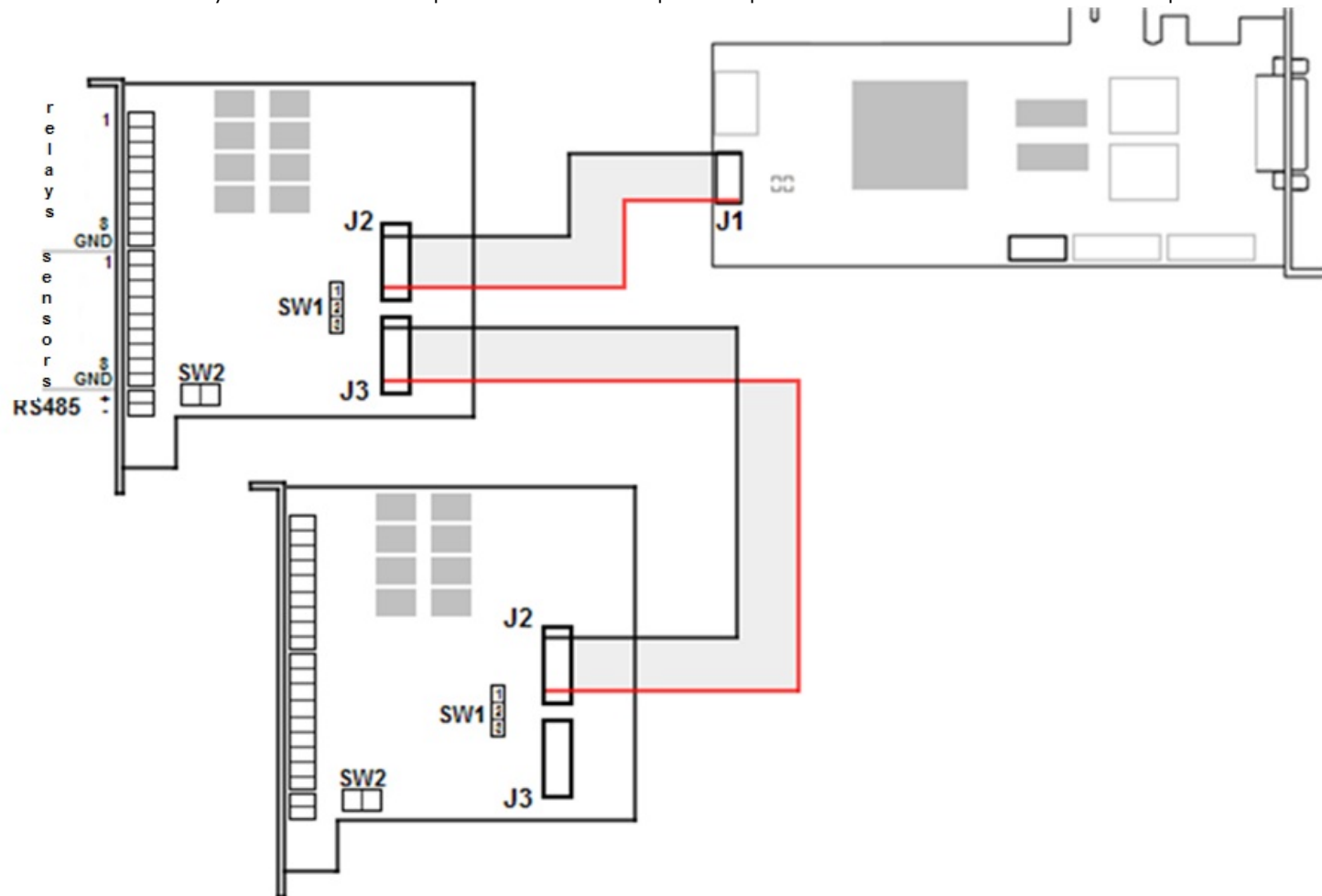

4. If it is necessary connect one more Sensor-Relay card. Connect the loop to the J3 connector on the first and to the J2 connector on the second Sensor-Relay card.
5. Install the Sensor-Relay card into a vacant motherboard slot and fix it in the casing.
6. Connect sensors and relays in accordance with the pinout of external pin of the Sensor-Relay card.

The Sensor-Relay is now connected.

Connecting MO USBIO 4x4 external module

The MO USBIO 4x4 module is an interface for external sensors (sensors) and external executive devices (relays) as a part of video surveillance and fire and security alarm systems.



External module is controlled via the USB interface. Electrical and technical specifications of the module are given in [Electrical and technical specifications of MO USBIO 4x4](#) section.

Configure the MO USBIO 4x4 external module as follows:

1. Connect the MO USBIO 4x4 module to the server via the USB cable included in the distribution kit.
2. To connect sensors and relays, unsolder the connector that is in the distribution kit. Unsoldering is made in accordance with the external connector pinout of the MO USBIO 4x4 module. Depending on the module modification one of the jack pinout shown in figure can be in use.

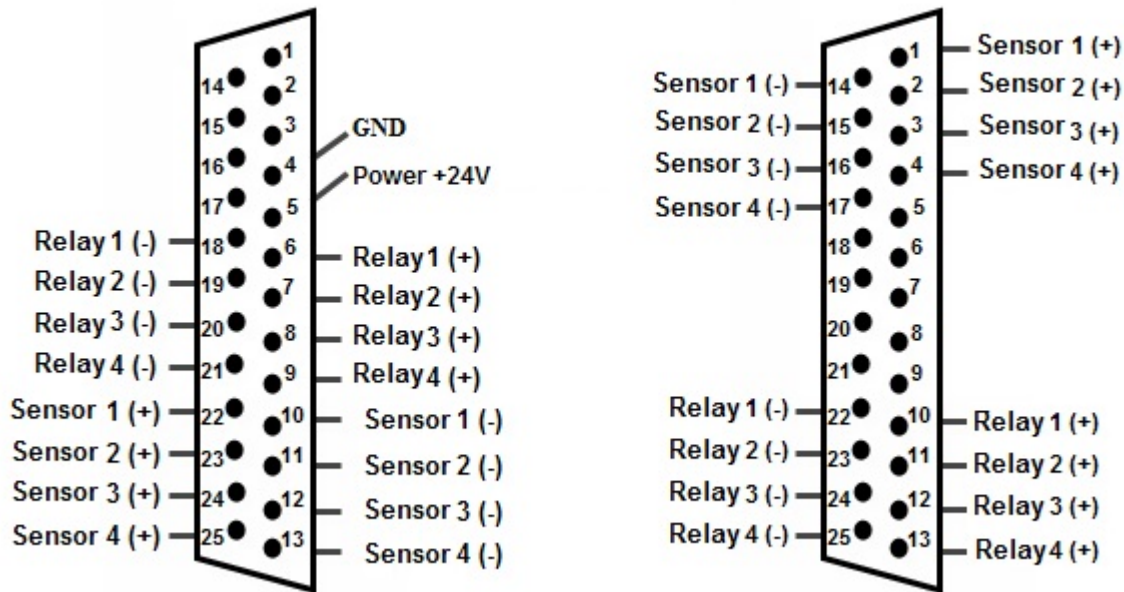

3. Fix the unsoldered connector in the casing in the distribution kit.
4. Connect ready-for-use connector to external connector of the card in order to connect sensors and relays to the Server.

The MO USBIO 4x4 external module configuration is completed.

Assembling and installing hardware components of audio subsystem

On the page:

- Supported audio cards and other audio input devices
- Options for increasing the number of audio input channels when standard audio cards are in use
- Installing audio input devices
- Installing microphones and loud speakers

INTELLECT™ software supports synchro video and audio recording and remote audio monitoring.

To enable operation of the audio subsystem, the Operator Workstation is to be equipped with optional equipment, such as audio cards, microphones, loud speakers and earphones.

Supported audio cards and other audio input devices

The following audio input devices can be used in the audio subsystem:

1. Standard audio cards installed in a computer or integrated into motherboards of computers.
2. Multi-channel audio cards such as Comart Hera, MidiMan Delta and Oikha 9P.
3. Ekholot USB-32, an external module for multi-channel audio signal input (32 channels).
4. Audio input channels of the network devices.
5. Audio input channels of FS/WS cards. As these cards do not have audio output channels for playing back the audio signal, an audio card is to be installed.

Options for increasing the number of audio input channels when standard audio cards are in use

INTELLECT™-based Server can process as many analog audio signals as specified in the license key.

As a rule a standard audio card has only one stereo audio input channel. To increase the number of audio input channels, the following options are offered:

1. Use a stereo audio input channel of a standard sound card as two independent mono-channels.
2. Use audio input channels of video capture cards.
3. Install several standard audio cards on the Server.



Note

Several audio cards of the same type installed within the system may cause conflicts in Windows OS.

4. Use multi-channel audio input cards (special audio cards support up to 16 independent audio input channels).
5. Use Ekholot USB-32, an external module for multi-channel audio signal input (32 channels).

Installing audio input devices

Information on how to install third-party audio cards and the drivers for them, as well as any other devices is given in the documentation bundled with specified equipment.

Sound channels of the network devices do not require any additional installation. The only requirement is that the device supports communication with the Server via the TCP/IP protocol.

Installing microphones and loud speakers

Microphones are to be installed in inaccessible places, ensuring unobstructed receipt of audio signals. Each microphone is connected to an audio card installed in a computer or to an audio connector on a video capture card.

Loud speakers or earphones designed for audio signal receipt are installed in the Operator Workstation. Loud speakers or earphones are connected to the audio output connector of the audio card.

The layouts of connectors for connecting microphones and earphones or loud speakers are given in the documentation bundled with audio cards.

Connectors bundled with a video capture card are used to connect microphones to these video capture cards.

Connecting PTZ devices and control panels



Attention!

Attention! Before one starts using a control panel or a PTZ device it is necessary to read the list of integrated devices and protocols at [AxxonSoft's official website](#). If the connected device is not in the list, then its operation is not guaranteed

PTZ device and control panel are connected to the Server via a vacant serial port (COM) (RS-232 interface).

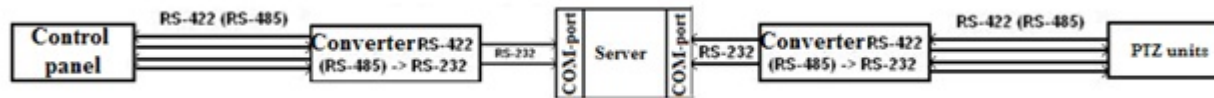

As a rule, PTZ devices use RS-422 or RS-485 interfaces. A PTZ device is connected to a COM port of the Server with RS-232 interface via RS-422 converter (RS-485) -> RS-232.

A PTZ device uses RS-422/RS-485 based on a 4-wires circuit (2 wires for receiving and 2 wires for transmission). To control PTZ devices in INTELLECT™, only 2 wires are used (transmitting data from the Server to the PTZ device). The **T+** and **T-** contacts of the converter are connected to the **R+** and **R-** contacts of the PTZ device.

The control panel is connected via converter RS-422 (RS-485) -> RS-232. Only two wires, connected to the Server, are used to control PTZ devices via control panel in INTELLECT™.

A PTZ device and control panel controlling this PTZ device are to be connected to one Server.

Detailed information on how to connect PTZ devices and control panels is given in the documentation accompanying the corresponding devices and converters. An example of controlling PTZ devices using the control panel is given in the [Telemetry configuration](#) section.

Connecting and configuring network devices

Network devices allow remote video surveillance and audio monitoring using the TCP/IP telecommunication environment.

Network devices can be defined as a self-contained hardware and software modules integrated in the digital video surveillance system using the TCP/IP telecommunication environment. To use network devices, the system requires connection to the telecommunication network using the TCP/IP protocol to interact with other components of the digital video surveillance system.

Network devices for video surveillance and audio monitoring are:

1. network cameras (IP-cameras);
2. various types of network videosevers.

Network cameras are designed for video surveillance and transmission of the digital video signal to the users via the TCP/IP telecommunication environment.



Note

If a network camera is equipped with an analog camera instead of a digital one, then a video signal is at first digitized by an AD converter embedded in the camera and then transmitted to the users via the TCP/IP telecommunication environment.

Network videosevers are connected directly to the analog cameras; they digitize analog video signal and transmit it to users via the TCP/IP telecommunication environment. The users who use analog cameras connected to the network servers can use the same functionality range for the video stream playback and transmission, as the functionality of network cameras.

Network devices are connected to Server network card using the standard RJ-45 connector.

Detailed information on how to connect network devices to Server is given in the documentation for corresponding network devices.

Configuring security system components in INTELLECT™ software

Configuring video capture cards in INTELLECT™ software

Video subsystem configuration

To configure a video subsystem in the *INTELLECT™* software create the **Video Capture Device** objects under which the **Camera** objects are created.

Creating and configuring the Video Capture Device object

Create the **Video Capture Device** object as follows:

1. Go to the **Hardware** tab in the **System settings** dialog box (1).
2. Select **Create object** -> **Video Capture Device** in the context menu of the **Computer** object (2).

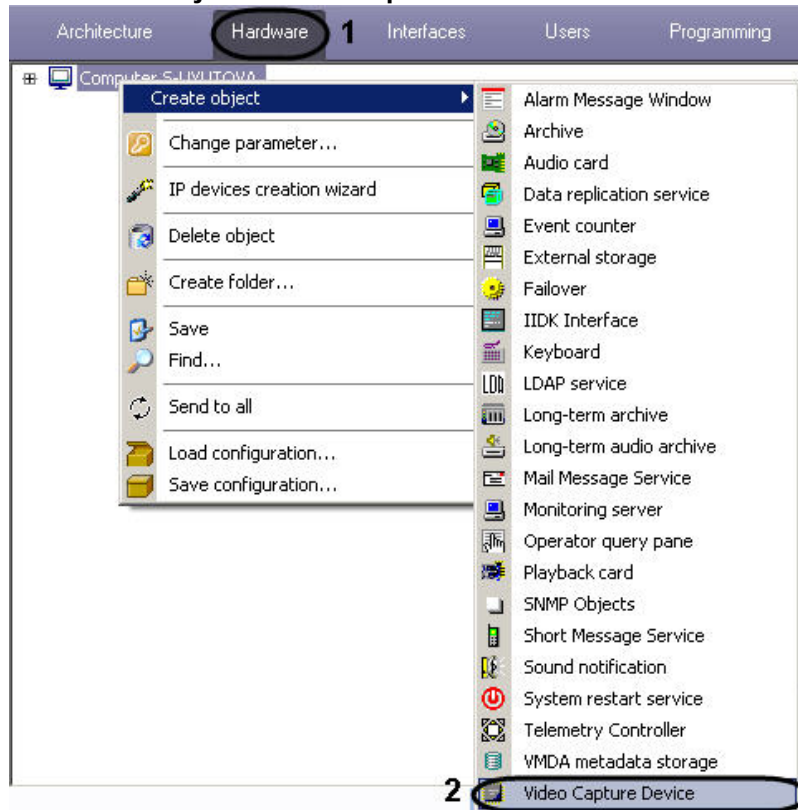

As a result the basic settings toolbar is displayed.

Number

Name

Apply Cancel



Note

Basic settings are set automatically. It is possible to change an ID, object name and parent object.

3. To create the object, click the **Apply** button.
4. Select the created object in the object tree (**1**).

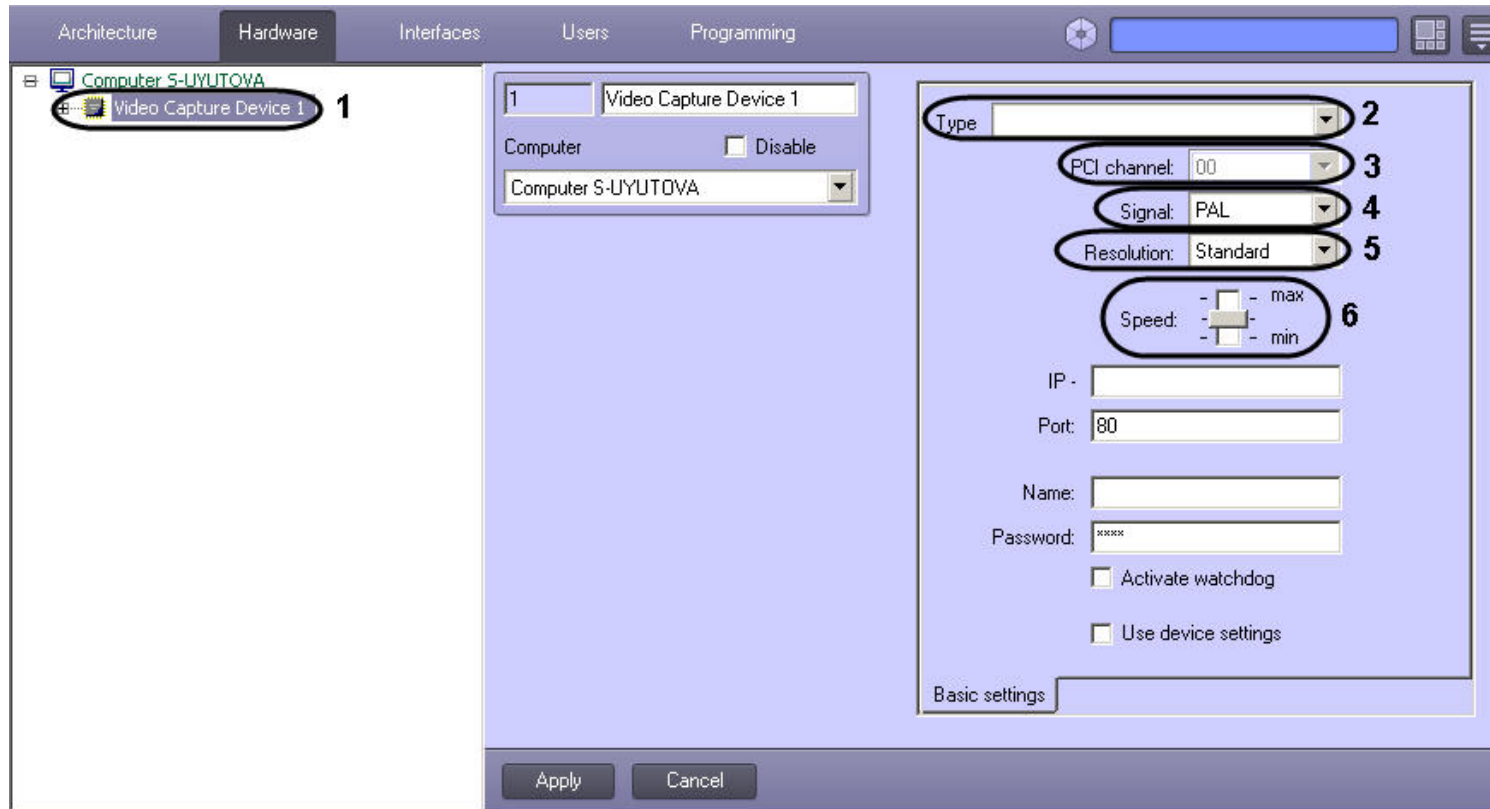

5. Configure the created object.
 - a. In the **Type** list select type of the video capture card installed on the Server (**2**).
 - b. Specify the PCI channel by selecting the value in the **PCI channel** list (**3**). For cards based on one chip model (ADC) and one driver (see [Drivers for video capture cards integrated into the INTELLECT™ software](#) section) there is end-to-end allocation of PCI channels that starts with '00'.



Note

While configuring SC300Q16 (FX4) or SC300D16 (FX8) or SC330Q16 (analogue of SC300Q16) or SC330D16 (analogue of SC300D16) video capture cards, take into account the correlation between the color of BNC video input interface cable and PCI channel specified by *INTELLECT™* software (see [Features of video subsystem configuration](#) section).

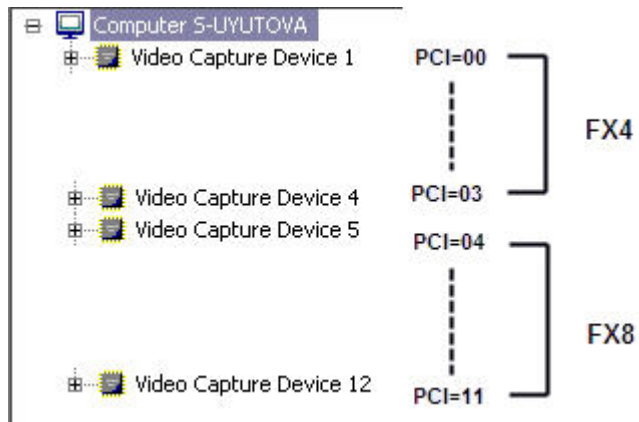

PCI channels allocation for cards based on one chip model (ADC)

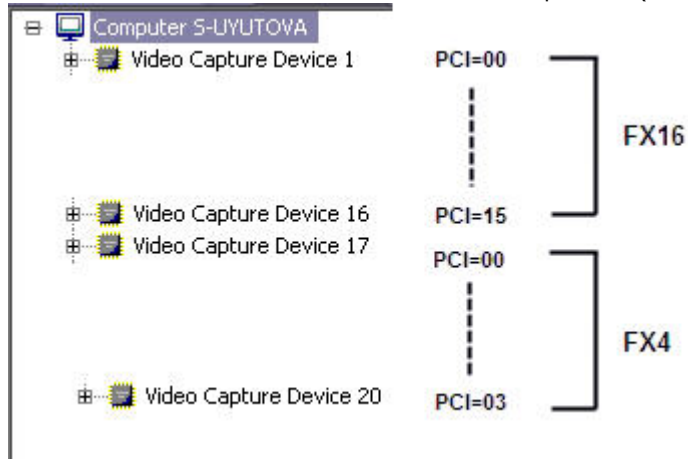

PCI channels allocation for cards based on different chip models (ADC)

- c. In the **Signal** list select the type of video input (PAL or NTSC) (4).



Note

When Stretch VRC 6004, VRC 6008, VRC 6416 and VRC 7008L cards are used, the video input (PAL or NTSC) is selected automatically depending on the camera connected to the card. Change of this parameter does not affect the card operation.



Note

When FX 116/416 cards are used, *INTELLECT™* software is to be restarted after changing the video input format. Otherwise the previous settings are active.

- d. In the **Resolution** list (5) select the **Standard**, **High** or **Full** resolution with which the video signal is captured. This action is to be carried out when WaveHub, LinuxHub or LinuxServer are configured, otherwise this step can be skipped.
- e. Specify allowable frame rate for the card by setting the **Speed** slider into the corresponding position (6).

Value	Description
Max	Maximum allowable sum of video frame rate
Mean	Half of allowable sum of video frame rate
Min	One third of allowable sum of video frame rate

f. Click the **Apply** button to save the changes.

Setting the **Video Capture Device** object is completed.

Attention! Configuration of one physical video capture card requires creation of several **Video Capture Device** objects (see [Features of video subsystem configuration section](#)).

Creating and configuring the Camera object

Create and configure the **Camera** object as follows:

1. Select **Create object** -> **Camera** in the context menu of the **Video Capture Device** object.

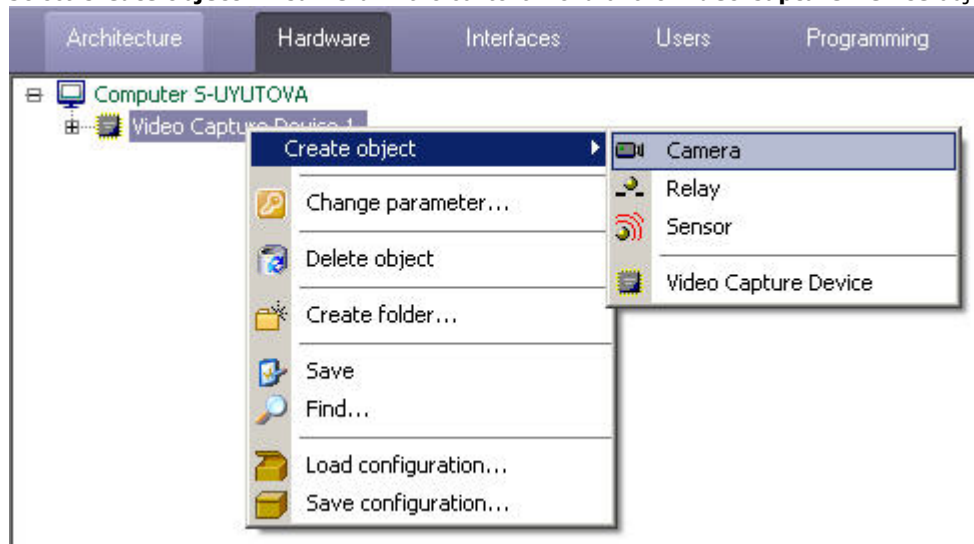

As a result the basic settings toolbar is displayed.

Note Basic settings are specified automatically. It is possible to change an ID, object name and parent object.

The image shows a configuration dialog box with a light blue background. It contains four input fields: 'Number' with the value '1', 'Name' with the value 'Camera 1', 'Region' which is an empty dropdown menu, and 'Video Capture Device' which is a dropdown menu showing 'Video Capture Device 1'. At the bottom of the dialog are two buttons: 'Apply' and 'Cancel'.

2. To create the object, click the **Apply** button.
3. Select the created **Camera** object in the object tree (**1**).

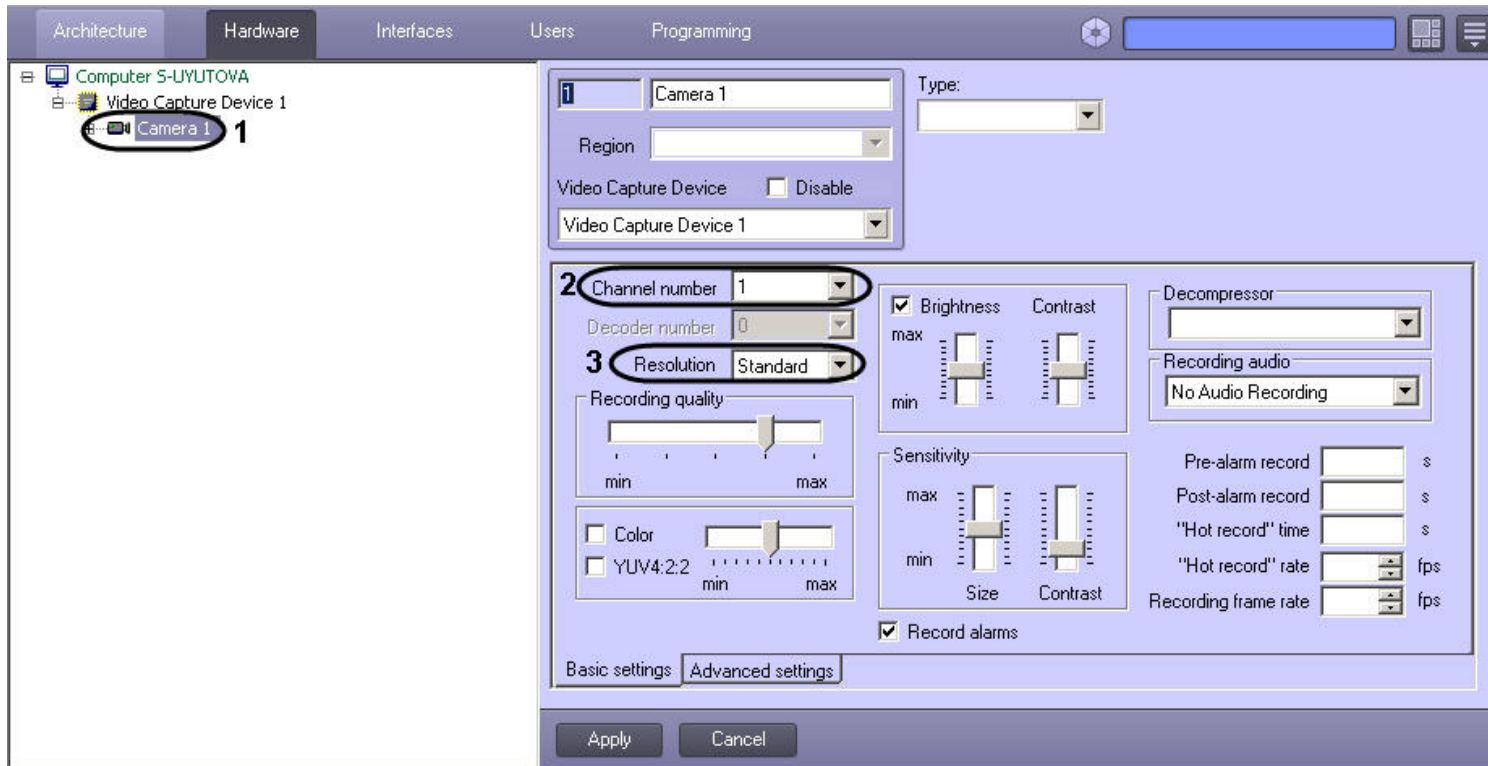

4. Configure the created object.
- In the **Channel number** list (2) select a physical video output of the card to which the camera is connected (see [Features of video subsystem configuration](#) section).

Note
Channel numbers within one Video capture card must not be repeated.

- In the **Resolution** list (3) select the resolution: **Standard** – minimum accepted value for the card, **High** – mean value and **Full** – maximum accepted value with which a video signal is captured.

Note
Resolutions supported by video capture cards are given in [Appendix 4. Technical specifications of video capture cards](#)

Note.
While configuring the video camera which is connected through the SC590N4 video capture card, in the Intellect software the frame resolution is to be set as the resolution set on the video camera. Otherwise, artefacts can appear on the video image.

Note

If Stretch VRC-6404 HD video capture card is in use, then restart Intellect after changing resolution.

- c. Click the **Apply** button to save the changes

Configuring the **Camera** object is completed.

Repeat these actions for all cameras connected to the card.

Note
Number of the **Camera** objects that can be created under **Video capture card** object is specified in [Features of video subsystem configuration](#) section.

Note
Detailed description of all settings of the **Camera** object is given in [Administrator's guide](#)

Configuring the analog video output

Expansion cards are used optionally and they bring out this functionality and installed directly on video capture cards. Intellect software brings out functionality of analog (decompressed and unprocessed) video output to external devices via corresponding BNC connector on video capture card (TV-out) (see [Installing the expansion card for analog video out](#) section).

Video outputting to analog monitor is made directly (without digitization) from one of the video cameras connected to Server.

Note
When configuring Intellect, take into account that outputting of analog video to analog monitor is possible from one camera only.

For video outputting to analog monitor a video capture card is to have an analog video output. An analog video output is integrated into FS-8 video capture cards. An extra analog video output card is to be installed for FS-5, FS-6 and FS-16 cards.

A video signal from any camera on the Server can be output to an analog monitor. By default, a video signal from the camera connected to the same video capture card as a monitor can be output to an analog monitor. To output video signals from any camera connected to any video capture card on the Server, solder analog outputs (interface cables) on all video capture cards on the Server.

Note
When an analog video out card is connected to a video capture card and analog monitor connector to the corresponding BNC-connector on the video capture card, analog video outputting to analog monitor is activated automatically.

Output the video from all cameras installed on the Server and connected to different video capture cards, to one analog monitor (perhaps when analog video outputs of cards installed on the Server are soldered) in `tweaki.exe` utility (Extended Intellect configuration) as follows:

1. Start **tweaki.exe** utility in the **Tools** folder of Intellect installation directory.
2. Select the **Video subsystem** section (1).

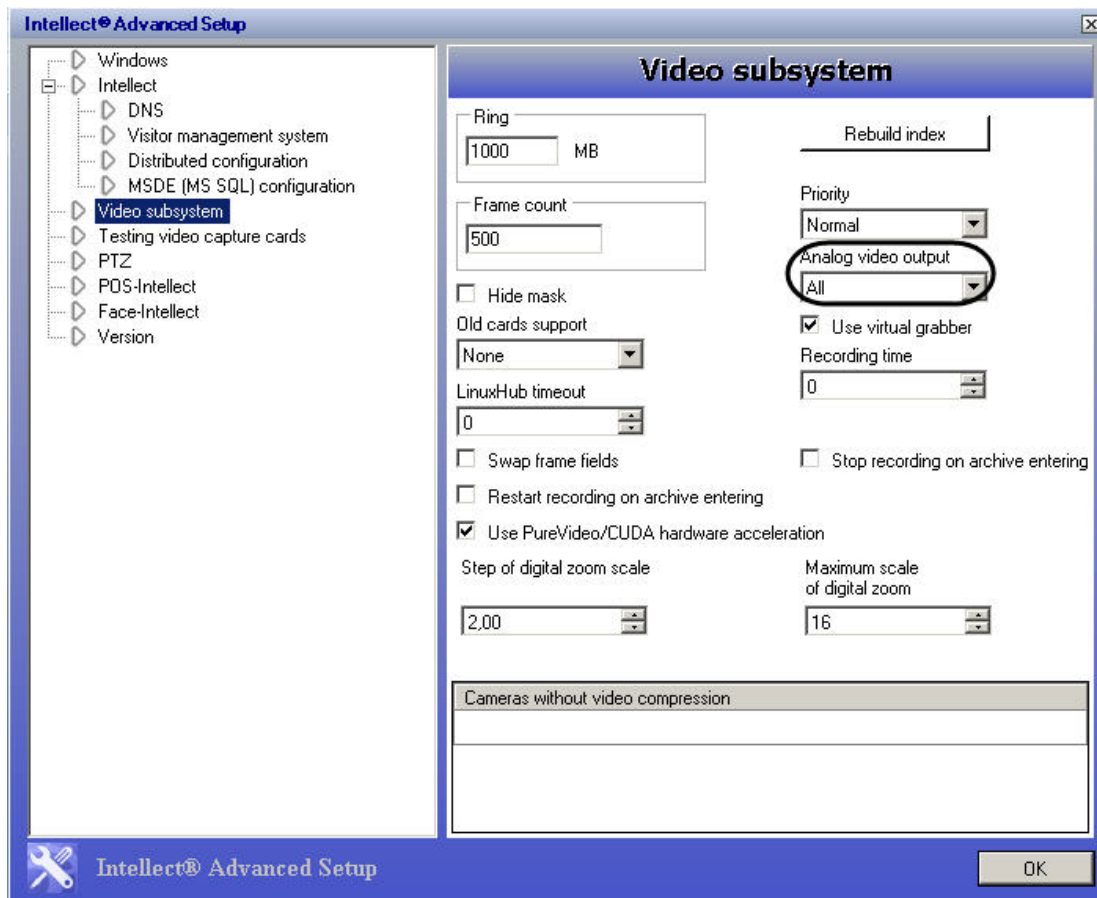

3. In the **Analog video output** list select the **One** item to activate outputting video from cameras connected to different video capture cards to one analog monitor (2). Video commutation (switching) while outputting them to analog monitor is performed only within cameras connected to one video capture. Changing the **Analog video output** parameter enables an extra program video commutator (switch) from all Server cameras connected to different video capture cards.
4. To save changes click the **OK** button.

If several analog cards are used, then the switch between cameras video from which is output to one analog monitor is made via macros and scripts (programs). For example for switching between two cameras one can create macros given in the table.

Macro	Operations			
	Type	Number	Name	Operation
Macro 1	Video capture card			Switch analog video out off 1
	Camera	1	Camera 1	Switch camera to output
Macro 2	Video capture card			Switch analog video out off 1

Camera	2	Camera 2	Switch camera to output
--------	---	----------	-------------------------

Note
Details on how to make macros is given in [Administrator's Guide](#)

Configuring Stretch video capture card

Configure Stretch video capture card as follows:

1. Go to the **Hardware** tab in the **System settings** dialog box.
2. Create the **Video Capture Device** object under the **Computer** object.
3. Select **Stretch (<compressor>)** in the **Type** list on the settings panel of the object. As a result the settings panel is refreshed (**1**).

Note
When the **Stretch(H264SVC)** type is selected:

- a) The number of available channels and speed of data input via them are decreased (see [Appendix 4. Technical specifications of video capture cards](#) section, technical specifications of VRC6004, VRC6008, VRC6416, VRC7008L and VRC6404HD video capture cards).
- b) Some video artifacts appear when the resolution is maximum.
- c) 'h264ffmpegdecoder' decompressor is recommended to be in use. Preferred decompressor is selected on the settings panel of the **Camera** object (see [Administrator's Guide](#)).

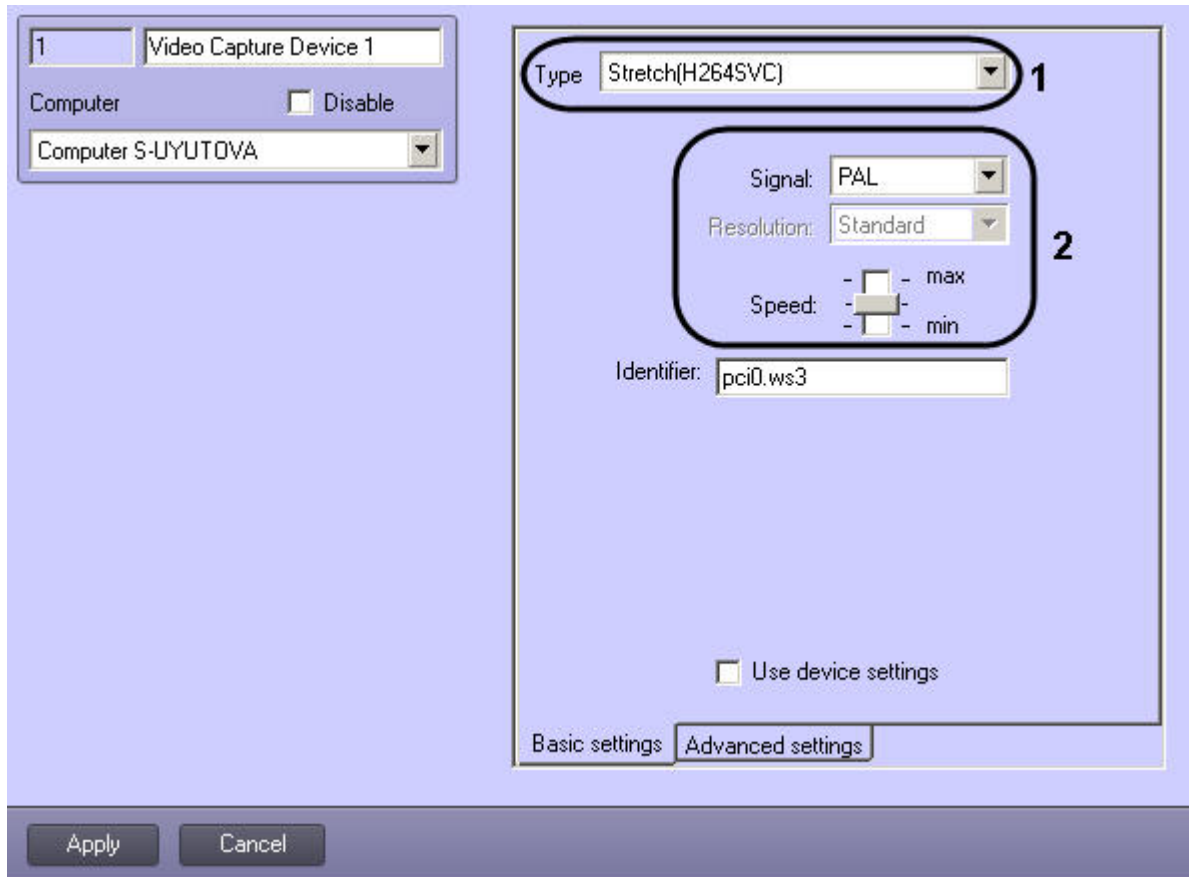

4. Set the values to the basic parameters of the card (2). Detailed description of parameters is given in [Creating and configuring the Video Capture Device object](#) section (see 5.c – 5.e steps).
5. Go to the **Advanced settings** tab (1).

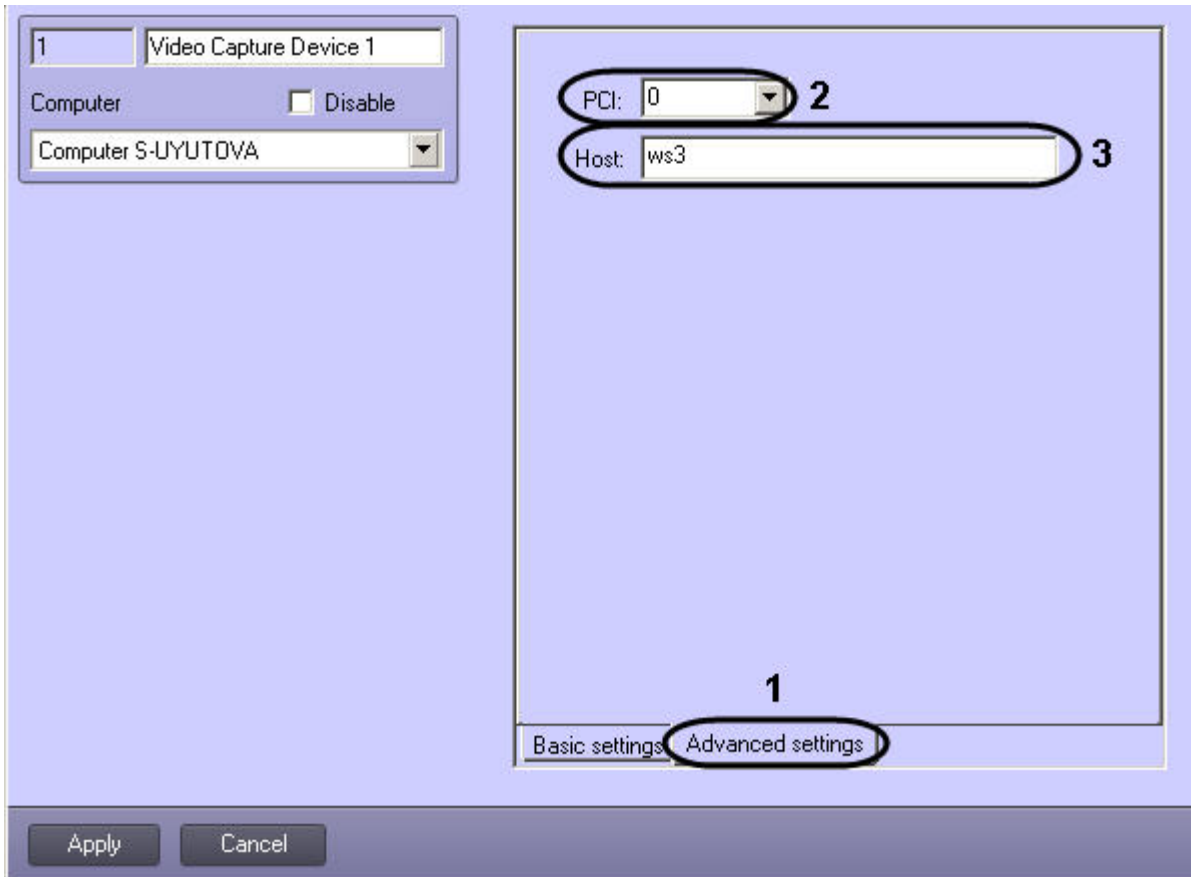

- a. In the **PCI** list select the PCI channel number (**2**). Features of PCI channel allocation are given in [Creating and configuring the Video Capture Device object](#) section (see 5.b step).
 - b. In the **Host** field enter the computer network name (**3**).
6. To save changes click the **Apply** button.
 7. Configure cameras connected to Stretch video capture card (see [Creating and configuring the Camera object](#)).

Configuring Stretch video capture card is completed.



Note

Camera discovery tool can be used to configure Stretch video capture cards in *INTELLECT™* software (see [Camera discovery tool](#) section)

Configuring HikVision video capture card

Configure HikVision video capture card as follows:

1. Go to the **Hardware** tab in the **System settings** dialog box.

2. Create the **Video Capture Device** object under the **Computer** object.
3. Select **HikVision(<compressor>)** in the **Type** list on the settings panel of the object.

Note
Camera discovery tool can be used to configure HikVision video capture cards in *INTELLECT™* software (see *Camera discovery tool* section).

Audio subsystem configuration

In *INTELLECT™* software the audio subsystem is configured with the help of the **Audio card** objects under which the **Microphone** objects (corresponding to connected audio devices) are created.

Creating and configuring the Audio card object

Create and configure the **Audio card** object as follows:

1. Go to the **Hardware** tab in the **System settings** dialog box (1).
2. Select **Create object** -> **Audio card** in the context menu of the **Computer** object (2).



As a result the basic settings toolbar is displayed.

Note
Basic settings are set automatically. It is possible to change an ID, object name and parent object.

Number

Name

3. To create the object click the **Apply** button.
4. Select the created **Audio card** object in the object tree (1).

The screenshot shows the hardware configuration interface with the following elements:

- Object Tree (Left):** A tree view under 'Computer S-UYUTOVA' containing 'Video Capture Device 1' and 'Audio card 1'. The 'Audio card 1' object is circled in red and labeled with a red '1'.
- Configuration Panel (Right):**
 - Number:**
 - Name:**
 - Computer:** Disable
 - Settings:**
 - Board:** (circled in red and labeled with a red '2')
 - Sample rate:** (circled in red and labeled with a red '3')
 - IRQ:**
- Buttons:**

5. Configure the created object.
 - a. In the **Board** list (2) specify the type and PCI channel of the card. Between the **Audio cards** objects there is end-to-end allocation of PCI channels that starts with '0'.
 - b. In the **Sample rate** list select the audio sample rate (3).

 **Important!**

If audio is received from IP device, then the value selected in the **Digitization** dropdown list is ignored. In this case the digitization rate is set in the driver parameters on the **Microphone** settings panel (see [Configuring audio acquisition from IP devices](#)).



Note

Using channels from FS 5\6\16 cards set 8000, 16000 or 32000 sample rates while configuring the LinuxHub audio card. Otherwise there is no guarantee of receiving audio from FS5\6\16 cards.

Set another sample rate if audio is received only from the embedded audio card.



Note

Sample rate for SC510N4 (FX HD4, SA 7160PCI) card (specified in the **Sample rate** list) is to be the same as the sample rate on the video camera. If rate values are not the same then slow-/fast-motion is possible.

- c. Click the **Apply** button to save the changes.
- 6. Configuring the **Audio card** object is completed.

Attention!
To configure one physical video capture card the creation of several **Audio card** objects is required (see [Features of audio subsystem configuration](#) section).

Creating and configuring the Microphone object

Create and configure the **Microphone** object as follows:

- 1. Select **Create object** -> **Microphone** in the context menu of the **Audio card** object.

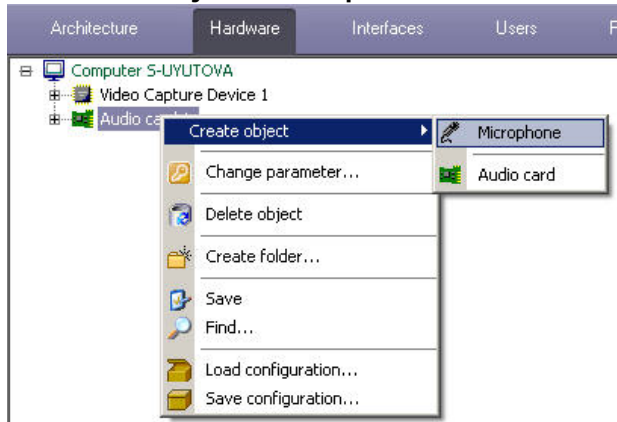

As a result the basic settings toolbar is displayed.



Note

Basic settings are set automatically. It is possible to change an ID, object name and parent object.

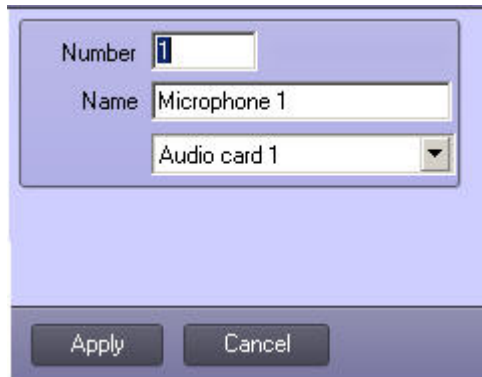

2. To create the object, click the **Apply** button.
3. Select the created **Microphone** object in the object tree (**1**).

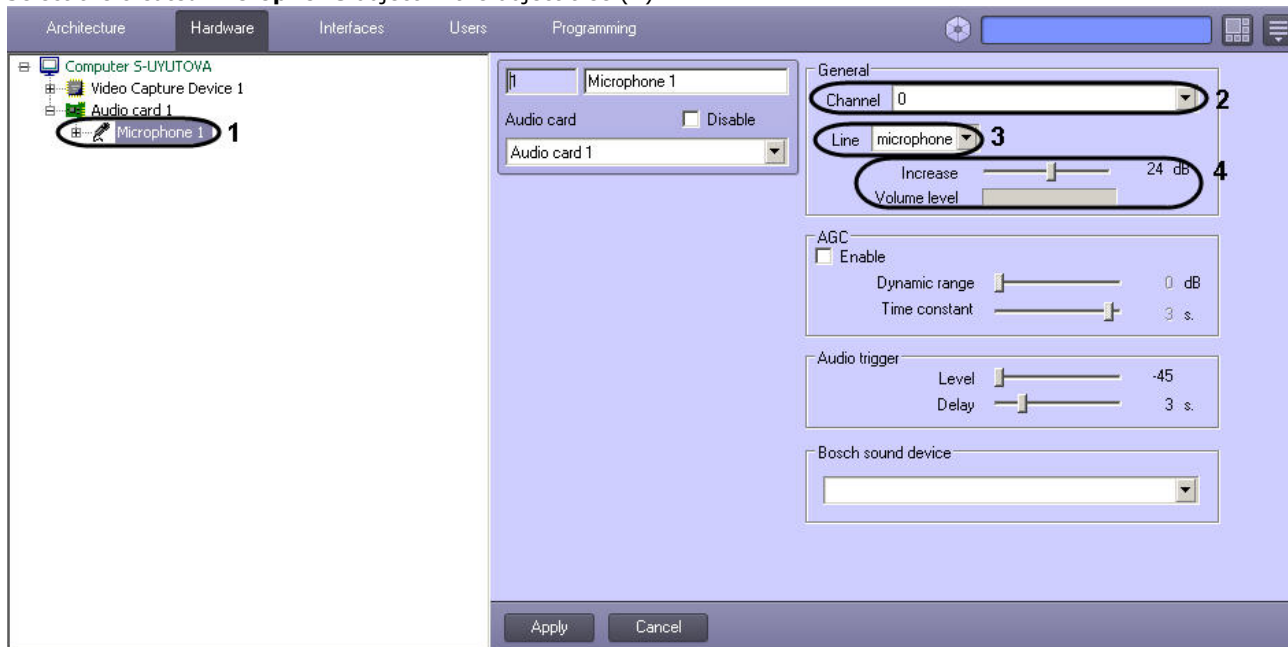

4. Configure the created object.
 - a. In the **Channel** list (**2**) select the channel to which the audio device is connected (see *Features of audio subsystem configuration* section).
 - b. In the **Line** list (**3**) select the device type (microphone, by default).
 - c. Configure the level of sound volume using the **Increase** slider. Sound availability in the specific microphone and the increase value are in the **Volume level** graphic scale (**4**).
 - d. Click the **Apply** button to save the changes.

Configuring the **Microphone** object is completed.

 **Note**
Number of the **Microphone** objects that can be created under one **Audio card** object is specified in [Features of audio subsystem configuration](#) section.

 **Note**
Detailed description of all settings of the **Microphone** object is given in [Administrator's guide](#).

Initial configuration wizard

One can configure video subsystem automatically in *INTELLECT™* software using the initial configuration wizard.

 **Note**
This opportunity is not provided for demo version of *INTELLECT™* software.

 **Attention!**
If the **Video capture card** or **Audio card** has already been created in *INTELLECT™* software, then the initial configuration wizard does not work.

Configure the video subsystem automatically as follows:

1. Go to the **Hardware** tab in the **System settings** dialog box **(1)**.
2. Select the **Computer** object related to the required Server in the object tree in the **Hardware** tab **(2)**.
3. Click the **Initial configuration wizard** button on the settings panel of the selected object **(3)**.

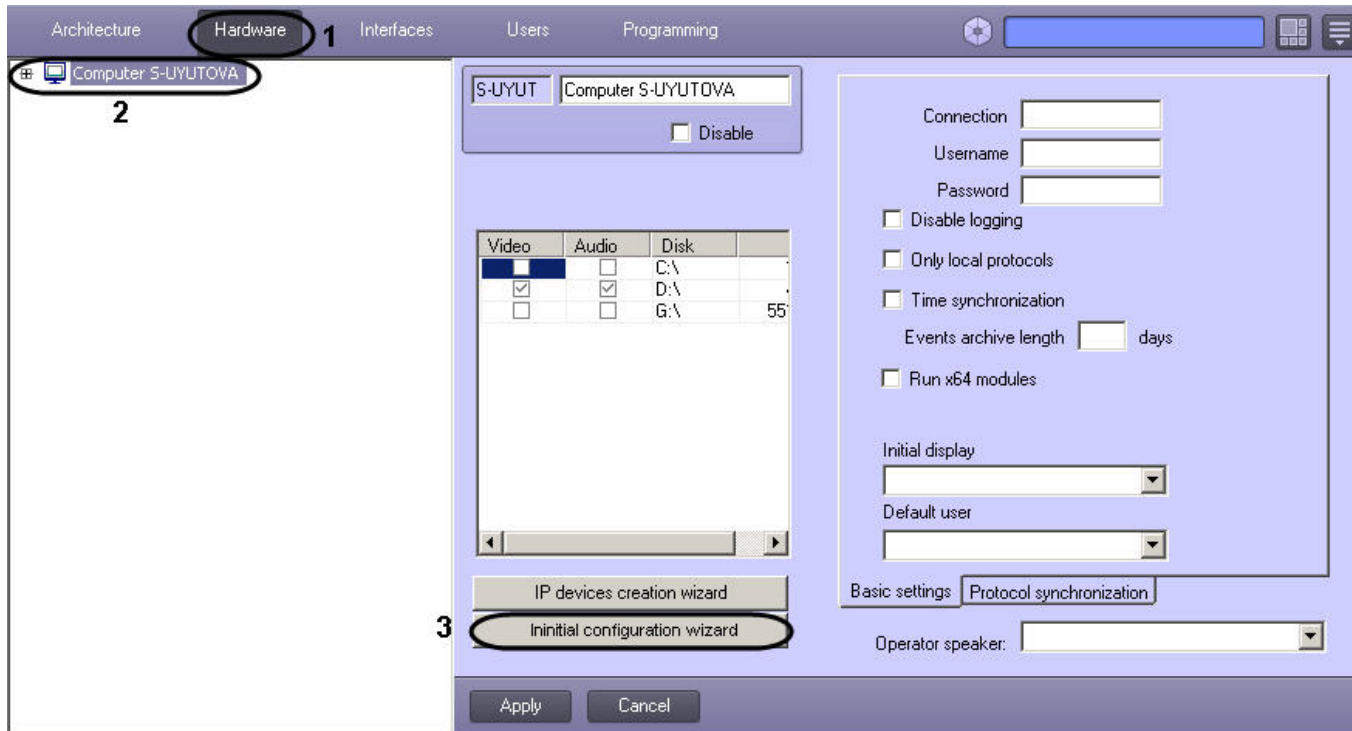

4. The **Creating initial configuration of the video subsystem** window is displayed.

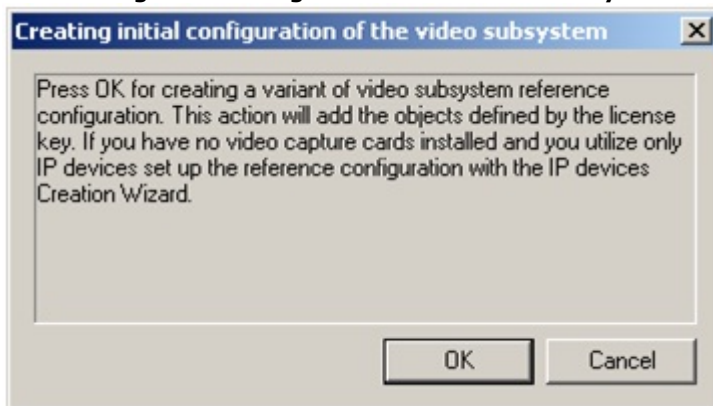

5. To create initial configuration of the video subsystem, click the **OK** button. This action will add objects based on Intellect software key.

6. As a result the created objects are displayed in the object tree.



Note

The following objects are created as a result of initial configuration wizard working:

- The **Video Capture Device** objects (specified in the key) that correspond to the physical video capture cards (for example, 4 **Video Capture Device** objects are created for one FS6/16 video capture card);
- The **Camera** objects - one for each **Video Capture Device** object;
- The **Audio card** object configured to work with a local audio card;
- The **Microphone** objects under the **Audio card** object (the number of the **Microphone** objects is equal to the number of audio channels in the key).

Initial configuration wizard does not create other objects that are given in the key.

The automatic configuration of video subsystem is completed.

Configuring the Watchdog hardware performance tester

Hardware performance tester is used for computer autoreboot in case of the Windows OS or main *Intellect* software modules failure.

INTELLECT™ software allows configuring the Watchdog hardware performance tester when using video capture cards that support this functionality (see [Appendix 4. Technical specifications of video capture cards](#)).

The Watchdog hardware performance tester on the Server with installed video capture cards is configured in 3 stages:

1. Make sure that the Watchdog hardware performance tester is connected correctly (see [Connecting the Watchdog hardware performance tester](#) section).
2. Activate the function of the Watchdog hardware performance tester on the settings panel of the **Video Capture Device** object.
3. Verify the Watchdog hardware performance tester.

Activate and verify the Watchdog hardware performance tester as follows:

1. Go to the **Hardware** tab in the **System settings** dialog box.
2. Set the **Activate watchdog** checkbox on the settings panel of the **Video Capture Device** object corresponding to one ADC on the card to which the Watchdog is connected (**1**)

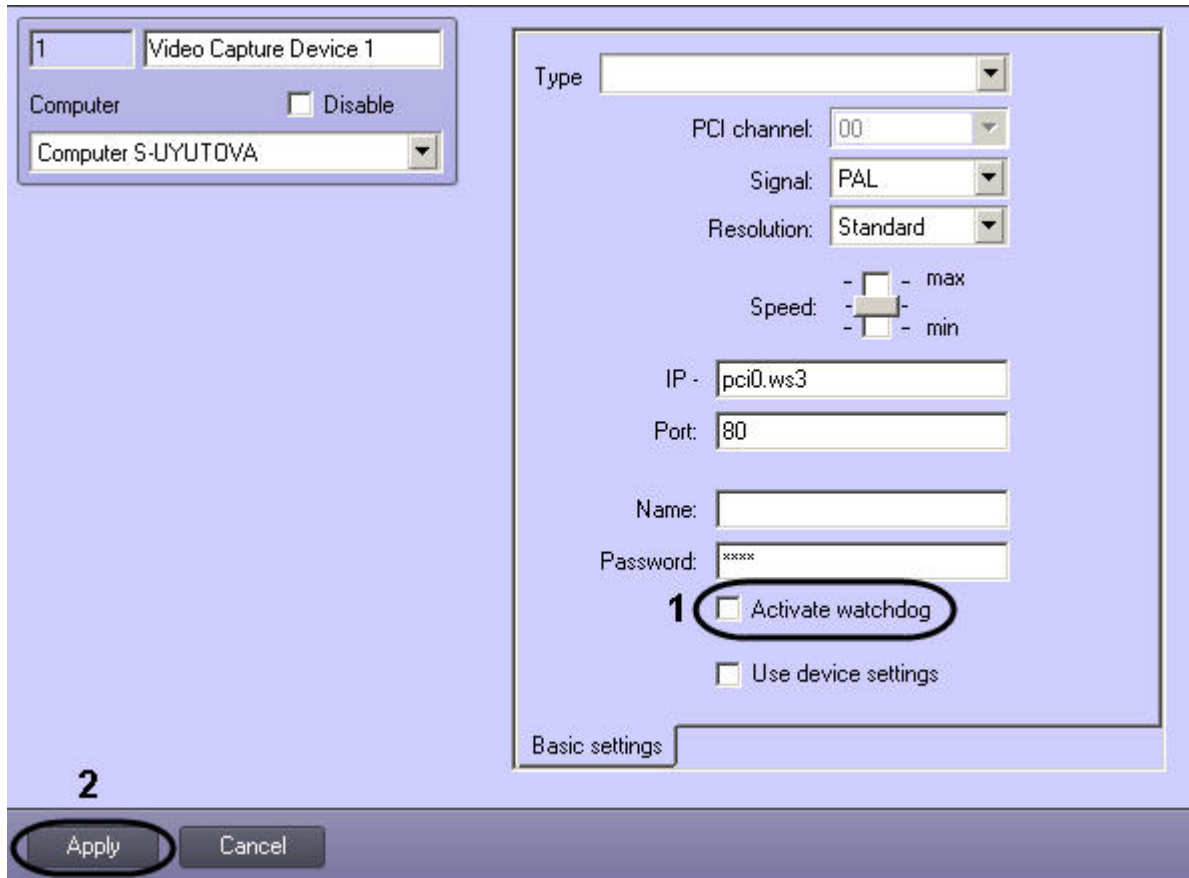

Note

When SC300Q16 (FX4), SC300D16 (FX8) or SC310N16 (FX16) as well as SC330Q16 (analogue of SC300Q16) or SC330D16 (analogue of SC300D16) video capture cards are in use, set the **Activate watchdog** checkbox checked in the settings of every **Video Capture Device** object created for the card to which the Watchdog is connected.

Note

The **07** PCI channel is to be selected for one of the **Video Capture Device** objects corresponding to the ADC of FS8 card for correct operation of the Watchdog hardware performance tester on FS8 video capture card. At the same time the Watchdog hardware performance tester can be activated on the settings panel of any **Video Capture Device** object of FS8 card.

3. To save the changes click the **Apply** button (2).
4. End the **video.run** process using the Windows task manager.

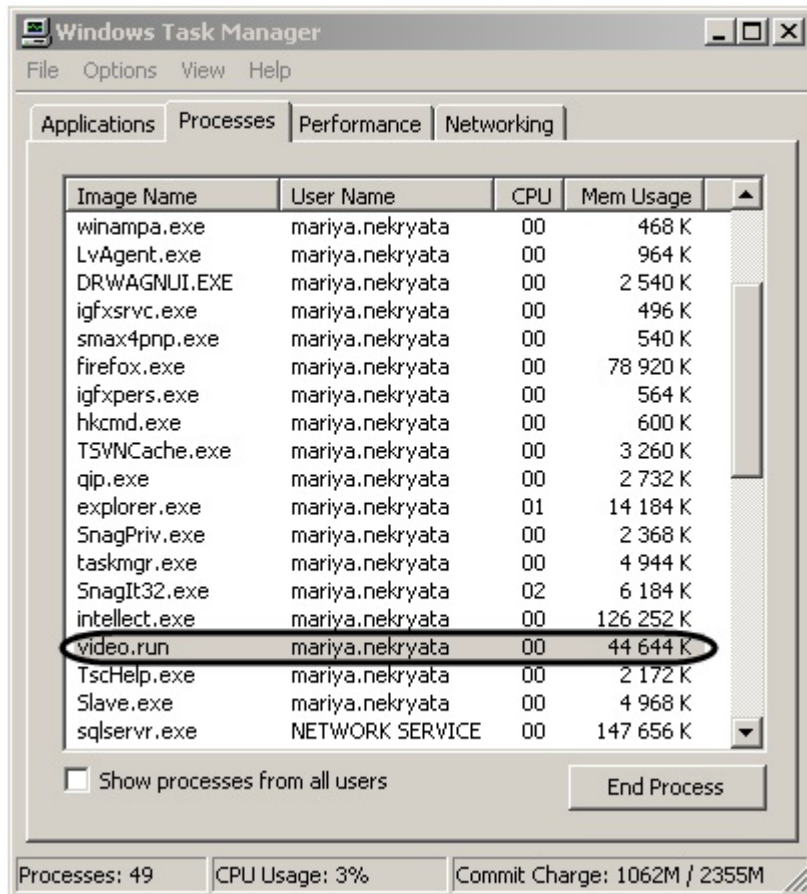

5. If the Watchdog hardware performance tester is connected and configured, then there is Windows reboot.

Note
On SC200Q4 (FS15) and FX video capture cards Windows reboots in several minutes after ending the **video.run** process.

Activation and verification of the Watchdog hardware performance tester is completed.

Configuring IP devices

General information on IP devices

INTELLECT™ software allows receiving, digitizing, processing and playing back the audio and video with the help of IP devices. IP cameras and IP servers can be used as IP devices for receiving, digitizing and processing the video.

IP device is configured with the help of Web server or another software bundled with this device and Intellect configuration.

Process parameters (size, frame rate, frame resolution, brightness, contrast, color saturation and color format) and parameters of video compression are set with the help of Web server or another software bundled with this device.

INTELLECT™ software receives and processes video with the help of detectors as well as records and transmits video from IP devices to remote workstations.

Intellect supports IP devices with dynamic IP address using DynDNS or other services. In these cases specify the address (hostname) given by DynDNS service instead of IP address when configuring IP devices.

Before using IP devices in *INTELLECT™* make sure that process and digitization parameters (codecs) of IP devices installed with the help of Web server are supported by *INTELLECT™*. The list of IP devices compatible with *INTELLECT™* and relevant information about the compatibility is shown on Axxonsoft's website in the 'Integration' section: http://www.axxonsoft.com/integrated_security_solutions/supported_ip.php.

Configuring video acquisition from IP devices

As a rule IP devices allow processing one or more video signals depending on the type of device in use.

Note.
Intellect does not support IP devices over https protocol. To find details about transport protocols, see [Changing the transport protocol used by IP-device](#).

Every IP device used for video input is registered in *INTELLECT™* software by creating and configuring the **Video Capture Device** object. The **Video Capture Device** objects are created in the **Hardware** tab under the **Computer** object. When the **Video Capture Device** objects are created the following parameters are to be set for every IP device:

1. In the **Type** list select IP device and codec used by this device.

Note
Codec is specified in brackets. If the codec is not specified, then MJPEG is set by default.

2. In the **IP address** field specify the assigned network address of IP device. Information on how to assign IP addresses is given in [Assigning network addresses to IP devices](#) section.
3. In the **Port** field specify the port number (TCP/IP) used for video transmission.
4. Specify the corresponding data in the **Name** and **Password** fields to log in Web server of IP device.
5. If the parameters set with the help of Web server or another software of IP device are to be used, then set the **Use device settings** checkbox.

Note
If video camera settings specified with the help of IP device software are not used in *INTELLECT™* software or used partially, then set the **Use device settings** checkbox unchecked and configure a video camera on the settings panel of the **Camera** object.

After logging in *INTELLECT™* the values corresponding to numbers of connection channels of video cameras to IP device are to be given to the **Chanel number** parameters of the **Camera** object.

Note
Set the **1** value for the **Chanel number** parameter when IP camera is configured. Otherwise IP camera is nonworking.

Configuring audio acquisition from IP devices

Every IP device used for audio input is registered in *INTELLECT™* by creating and configuring the **Audio card** object. The **Audio card** objects are created in the **Hardware** tab under the **Computer** object. When creating the **Audio card** objects in the **Board** drop-down list select the value corresponding to the designation of IP audio device followed by its IP-address. This value is available in the drop-down list only if the **Video capture device** object corresponding to the IP-device is created and configured (see [Configuring video](#)

acquisition from IP devices section). Also the **Audio card** and **Video Capture device** objects corresponding to the one IP-device should be created on the basis of the same **Computer** object.



When the **Audio card** is configured restart *INTELLECT™*. Otherwise the audio subsystem (particularly, microphones) can not be configured.

Microphones embedded into or connected to IP devices are registered in *INTELLECT™* by creating the **Microphone** objects under the **Audio card** object. Under one **Audio card** object there are the **Microphone** objects in amount corresponding to the amount of audio input channels and restrictions applied by a license key. Corresponding segment of hardware branch when IP device and one microphone are registered is shown in the figure.



When the **Microphone** object is created, select the channel number of connecting the microphone to audio input device in the **Channel** dropdown list.

Moreover driver parameters can be set in order to acquire audio from IP device. The list of available parameters depends on the device in use and it is shown in the **Driver parameters table on the settings panel of the Microphone object**.

Driver parameters	
Parameter	Value
Codec	G.711
Baud rate	64000
Encrypting	u-law

For instance, audio digitization rate (**Send rate**) can be set like this. The value of the **Digitization** parameter set on the settings panel of the parent **Audio card** object is ignored. Find details on how to select the codec and digitization rate in *Intellect* in [Configuring the digitization devices for audio signals](#) section in [Administrator's Guide](#).

Camera discovery tool

Create IP devices in the *INTELLECT™* software as follows:

1. Go to the **Hardware** tab in the **System settings** dialog box (1).

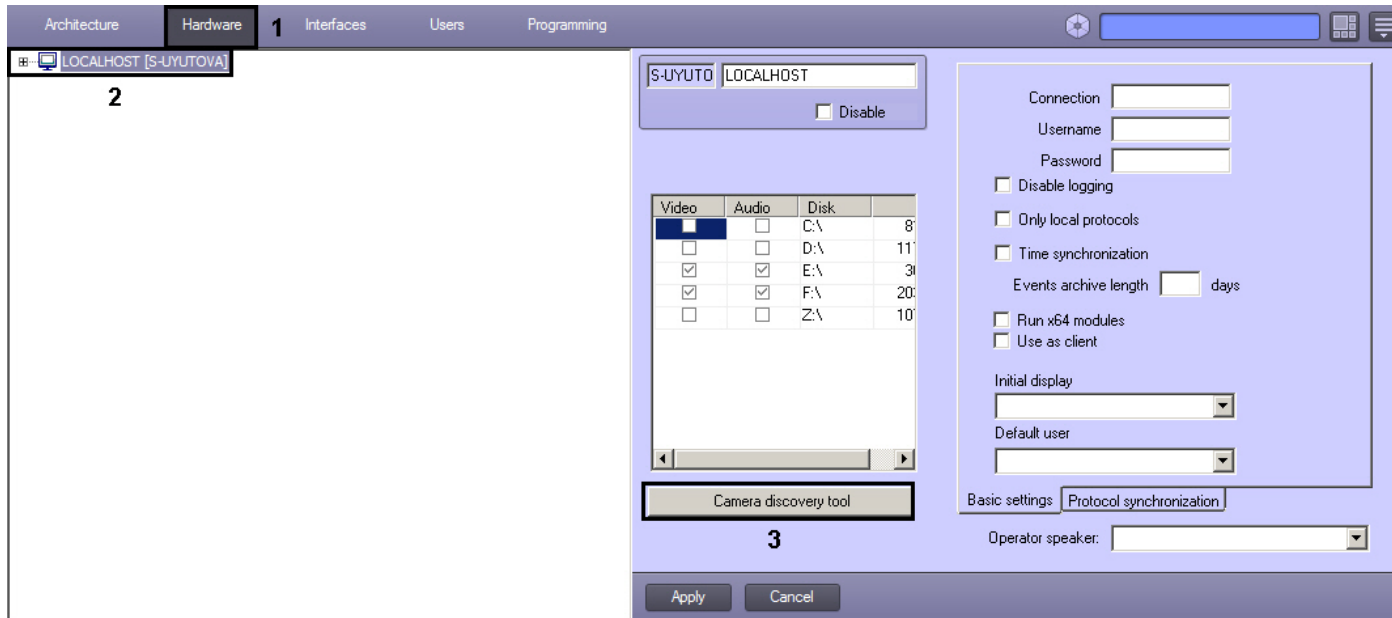

2. In the object tree select the **Camera** object corresponding to the configured Server (**2**).
3. Click **Camera discovery tool** on the setting panel of the selected object (**3**).

As a result the **IP Wizard** window is displayed. Found IP devices are displayed on the top of the window.



Note

The **IP Wizard** window can also be displayed by selecting the **Camera discovery tool** item in the context menu of the **Computer** object.

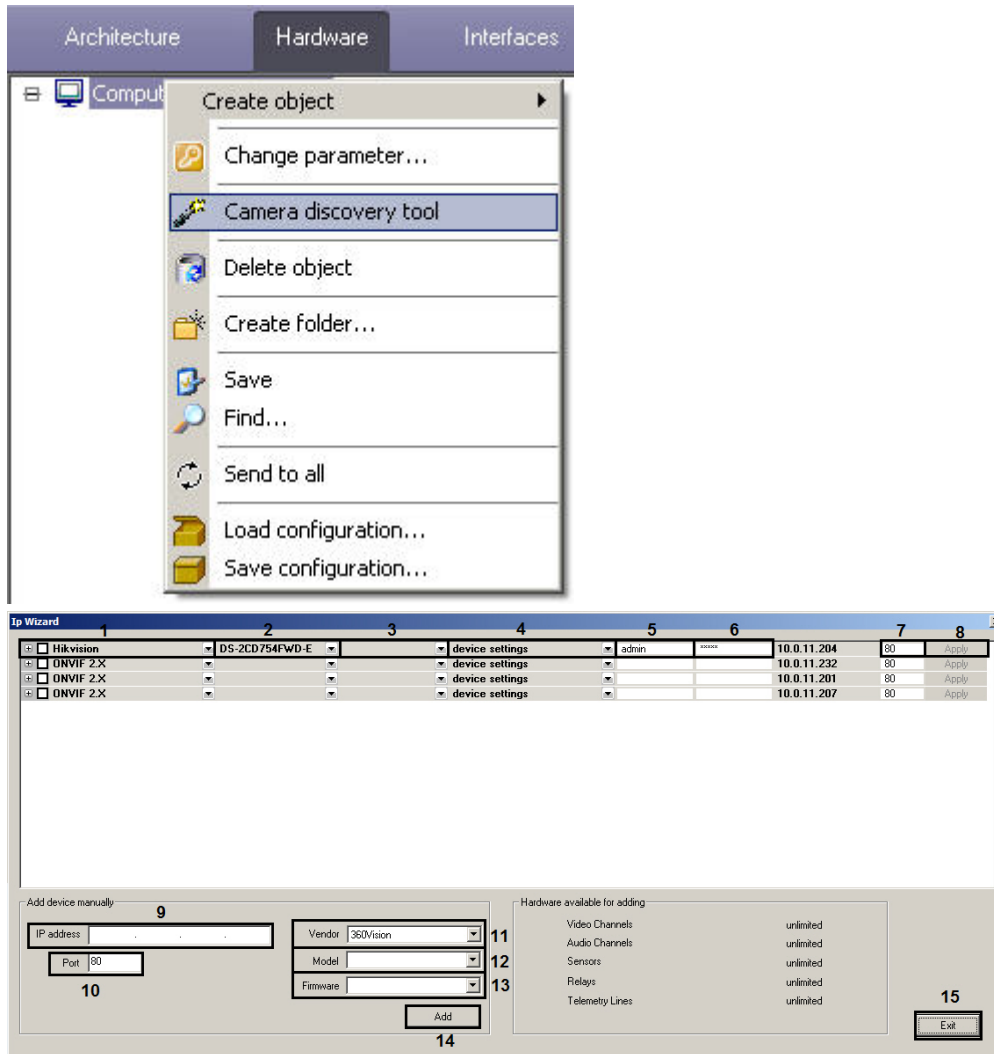

4. Check up the vendor (1) and model (2) for found IP device. Make changes if necessary by opening the corresponding dropdown list and selecting required value.
5. From the drop-down list (3) select settings which should be installed on the IP-device while its adding to the device tree: leave installed **device settings** or apply **video server settings**.
6. Check up the TCP/IP port (6). Specify the required value in the field.
7. Specify the login (4) and password (5) to connect IP device. Login and password are specified in the documentation for connected network device.
8. Select the objects that are to be created under IP device.

Note

The number of objects that can be created under IP device is displayed automatically in the **Hardware available for adding** table.

a. Open the dropdown list of supported IP device by clicking the  button.



Correspondence of object names in IP Wizard to the branches of object tree is in table.

Name of object in IP Wizard	Branch of object tree in <i>INTELLECT</i> [™]
Video channel	The Video Capture Device object -> The Camera object
Audio input	The Audio card object -> The Microphone object
Contact	The Video Capture Device object -> The Sensor object
Executive device	The Video Capture Device object -> The Relay object
Telemetry line	The Telemetry controller object -> The PTZ device object
Audio output	The Playback card object -> The Loudspeaker object

b. Set checkboxes for objects that are to be created.



Note

To create/delete all objects set the checkbox checked/unchecked next to the vendor of IP device.

9. Click the **Apply** button (7).

The selected objects are created automatically in the **Hardware** object tree.



Note

When this manual was written, audio input of DS-4016HCI video capture card had not been integrated with *INTELLECT* yet. So, when this card is added using the **Camera discovery tool**, the **Audio card** and **Microphone** objects are not created.

10. Repeat steps 4-8 for each IP device that is to be created in the system.



Note

To delete the IP-device from the *IP Wizard* window right – click the corresponding line in the table and select the **Delete camera <IP address> from the list** item. To delete the IP-device object or objects created under it from the hardware tree by means of the *IP Wizard*, set the checkboxes unchecked for corresponding objects and click the **Apply** button.

11. If the IP device has not been found, then add it manually.
 - a. Specify the IP address of device in the **IP address** field (**8**).
 - b. Specify the number of TCP/IP port in the **Port** field (**9**).
 - c. Select the vendor of IP device in the **Vendor** dropdown list (**10**).
 - d. Select the model of IP device in the **Model** dropdown list (**11**).
 - e. Click the **Add** button (**12**).
 - f. In the **Firmware** dropdown list select the firmware installed on the IP device (**13**).
As a result The IP device with specified parameters is displayed on the top of the window.
11. To complete the IP device creation repeat steps 6-8.
12. Click the **Exit** button to close the IP Wizard window (**14**).

IP device creation is completed.

Connecting devices over standard protocols

Configuring multimedia receipt using RTSP protocol

To receive multimedia stream from a camera via RTSP protocol, the camera is to support this protocol. Information on RTSP support is in official reference documentation for the camera.

For proper operation of RTSP grabber functionality, make sure that no settings prevent data transmission via RTSP protocol.

 **Note.** To receive the RTSP stream it's required to set the multicast value to the rtsp parameter in the HKEY_LOCAL_MACHINE \SOFTWARE\ITV\Intellect\Video\TransportProtocols registry key for 32-bit system (HKEY_LOCAL_MACHINE \SOFTWARE\Wow6432Node\ITV\Intellect\Video\TransportProtocols for 54-bit) on computer where the **Camera** object is created if RTSP stream is received from the rtsp-server of the *Intellect* software (see [Configuring rtsp Server module](#)). More information about this parameter see in [Changing the transport protocol used by IP-device](#) section.

To receive video via RTSP protocol, do the following:

1. Create the **Video Capture Device** object on the basis of the **Computer** object in the **Hardware** tab of the **System settings** dialog box (1).

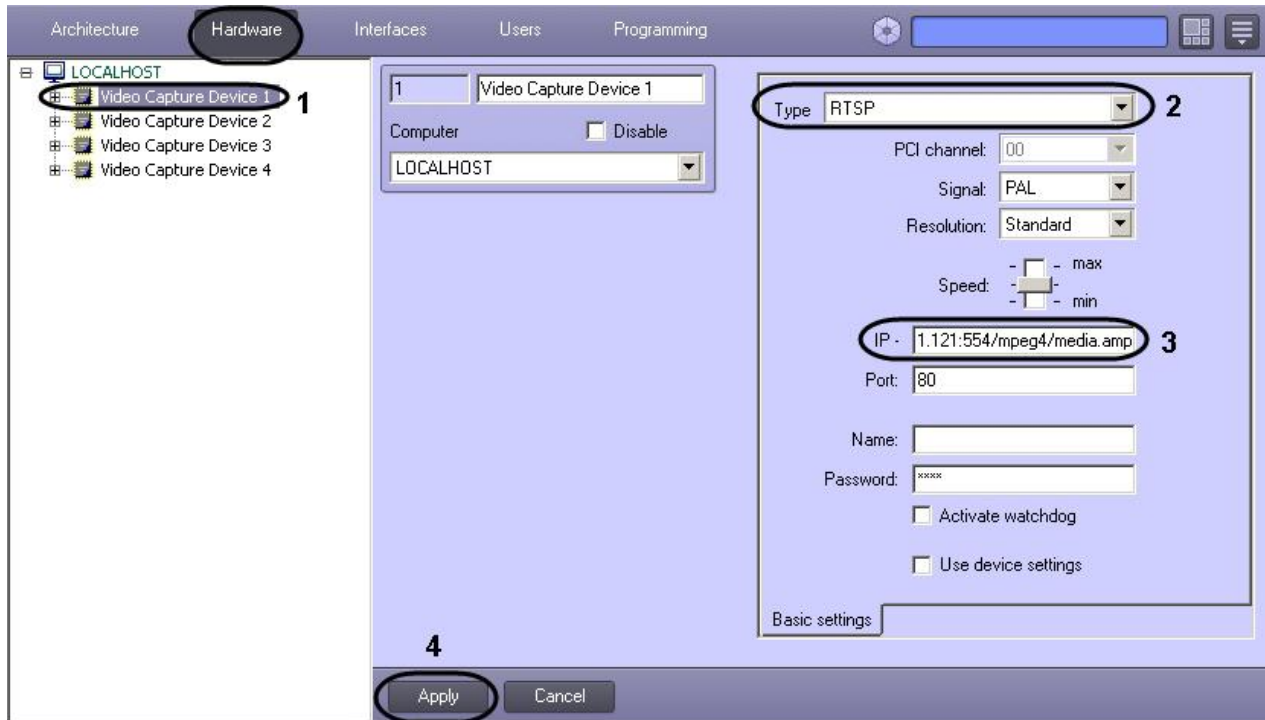

2. Go to the settings panel for the created object.
3. Select the **RTSP** value in the **Type** dropdown list (2).
4. Type-in the address of rtsp-stream in the IP field (3). The length of address is not to be longer than 100 characters.
The format of address depends on camera model and its firmware. It is specified in the technical documentation of the vendor. Generally it looks like this:
rtsp://[<username>:<password>@]<IP address of video source >:<port>/<path_to_stream>

Example 1.
For Axis 210A camera the address of rtsp-stream looks like this: `rtsp://root:password@10.0.11.121:554/mpeg4/media.amp`

Example 2.
The address to access rtsp-stream delivered by rtsp Server of INTELLECT, looks like `rtsp://192.168.0.3:554/1`. When rtsp Server operates in the **Multicast** mode, it cannot be accessed via RTSP grabber.

Receiving multiple streams via the RTSP driver has been implemented in Drivers Pack v. 3.2.28.1518 and over. Maximum 3 streams are supported. RTSP addresses are semi-colon separated in the **IP** field.

Example.
To get video from two streams, specify `rtsp://admin:admin@10.0.26.16/live/h264;rtsp://admin:admin@10.0.26.16/live/mjpeg` in the **IP** field.
To get video from three streams:
`rtsp://admin:admin@10.0.26.16/live/h264;rtsp://admin:admin@10.0.26.16/live/mjpeg;rtsp://admin:admin@10.0.26.16/live/mpeg4`

5. Click the **Apply** button to save the settings of the **Video Capture Device** object (4).
6. Create the **Camera** object on the basis of the **Video Capture Device** object.

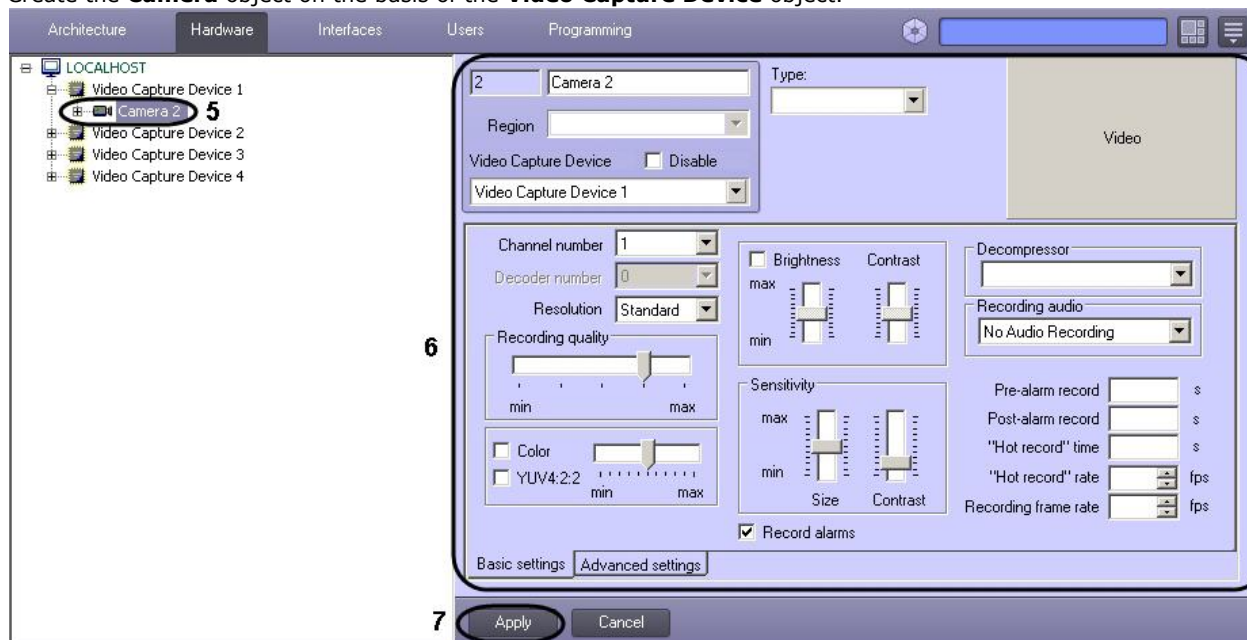

7. Configure the created **Camera** object (5).
8. Click the **Apply** button (6).
9. Click the **Video** button to check if the video is available (7).

If the configuration is correct, video received via RTSP protocol is displayed in the viewing area. Further actions with received video stream are performed using the created **Camera** object.

Video-streaming via RTSP protocol is now configured.

To receive audio stream from a camera, create and configure the **Audio card** and **Microphone** objects for audio received via RTSP protocol. For this select the **RTSP** type of the **Audio card** (see figure and Registration of audio cards and microphones in INTELLECT™ software section).

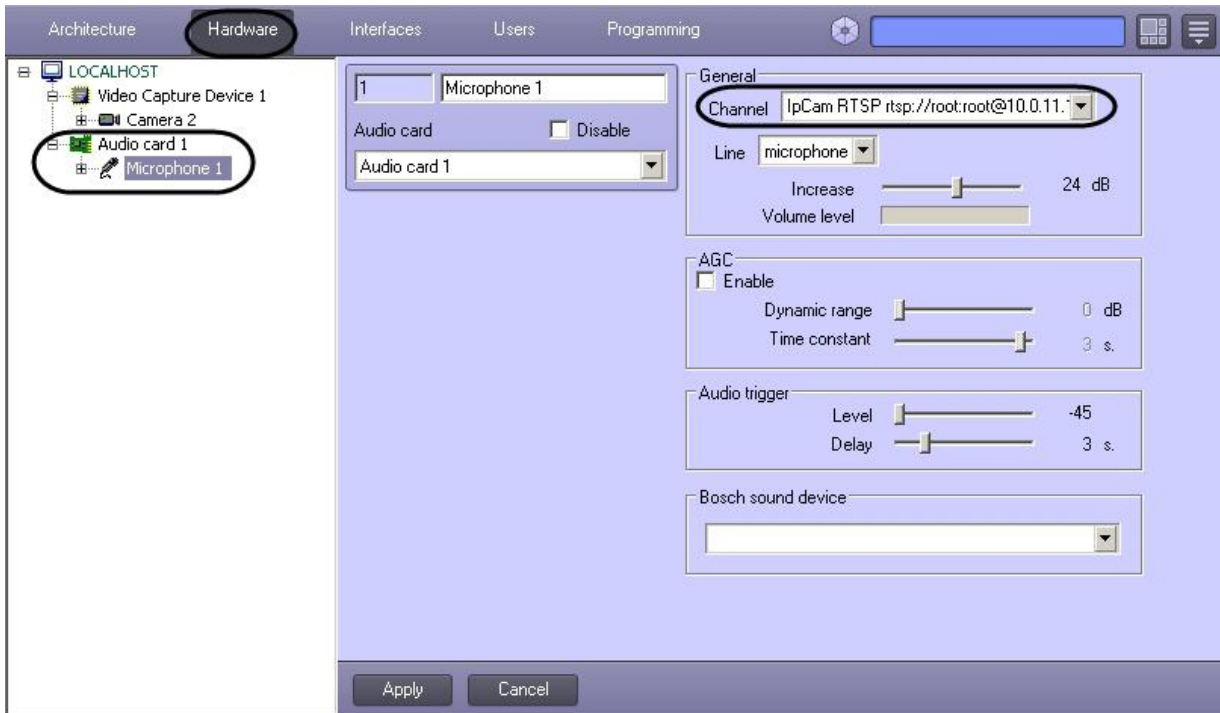

Further actions with received audio stream are performed using the created **Microphone** object.

Connecting cameras via the GB/T28181 protocol

Intellect supports connecting devices via the Chinese standard GB/T28181. As of when this document was written, *Intellect* supports H.264 video and telemetry. For the most up-to-date information on this standard and the features supported in *Intellect*, see the [Documentation Drivers Pack](#).

Note. Configuration of IP devices connected via GB/T28181 is performed through the web interface of the devices. Settings are not sent from *Intellect* to the device.

Before connecting a camera via this protocol to *Intellect*, perform the following steps to configure the device:

1. Set the Server IP to equal the Server's IP address.
2. Set the Server port to 5060.
3. Set the Device ID. The ID should be set on all cameras connected via the GB/T28181 protocol and must be unique.
4. For the device to perform autodiscovery of the Server more quickly, reduce the default value of RefreshRegTime.

Note. The name of this setting may vary on some cameras.

Note.
For telemetry to work correctly, set RefreshRegTime to more than 600.

Attention!
For a camera to work correctly via GB/T28181, it must be on the same LAN as the Server.

Note.
Intellect does not support auto-discovery of devices connected via GB/T28181 and these devices are not added using the Camera discovery tool.

After configuring the device as described earlier, add it to *Intellect* as follows:

1. Go to the **Hardware** tab of the **System settings** dialog box (1).

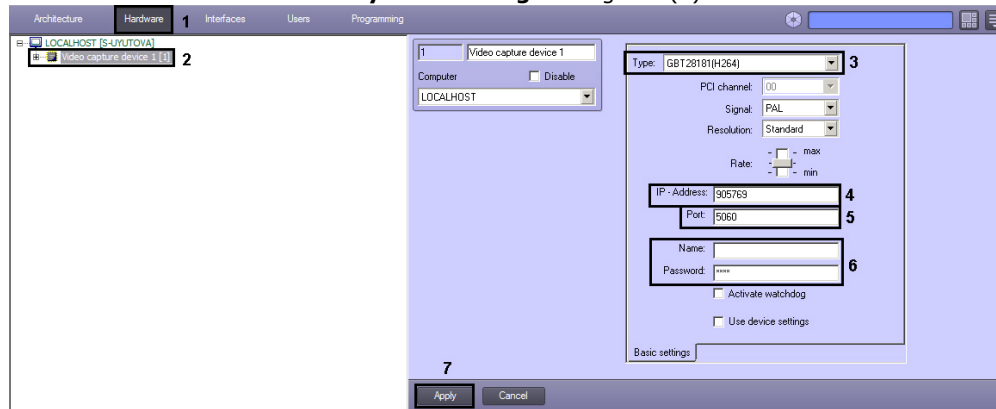

2. Create a **Video Capture Device** object under the **Computer** object (2). The settings panel of the object appears on the right of the **System settings** dialog box.
3. Select the **GBT28181(H.264)** value in the **Type** dropdown list (3).
4. In the **IP** field specify the value of Device ID parameter set during IP device configuration (4).
5. Enter **5060** in the **Port** field (5).
6. Enter the user name and password to connect a device (6).
7. Click the **Apply** button (7).
8. Create a **Camera** object under the **Video Capture Device** object. The settings panel of the object appears on the right of the **System settings** dialog box.

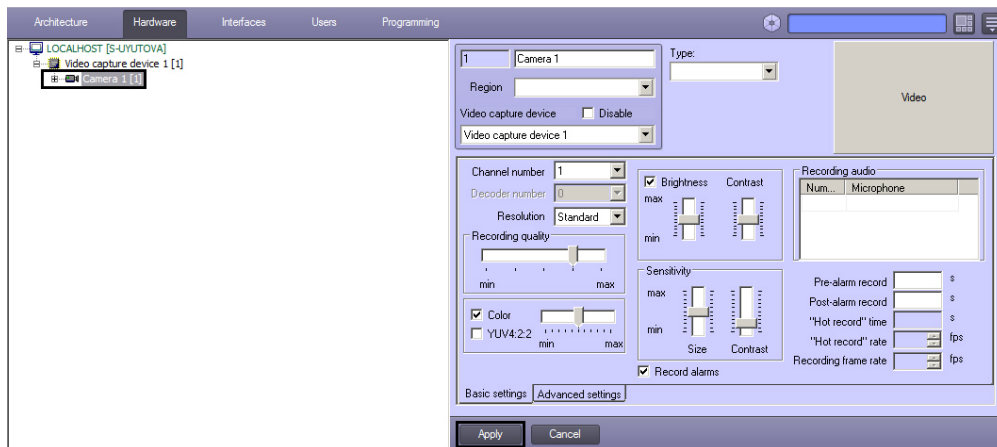

9. Click the **Apply** button.

Further functioning of the device is performed using the created **Camera** object – see [Configuring video subsystem](#) section of [Administrator's Guide](#).

A camera via GB/T28181 protocol is now added.

Connecting cameras via the ONVIF protocol

Intellect supports connecting devices via the ONVIF protocol. Add an ONVIF device in *Intellect* as follows:

1. Open [Camera discovery tool](#).

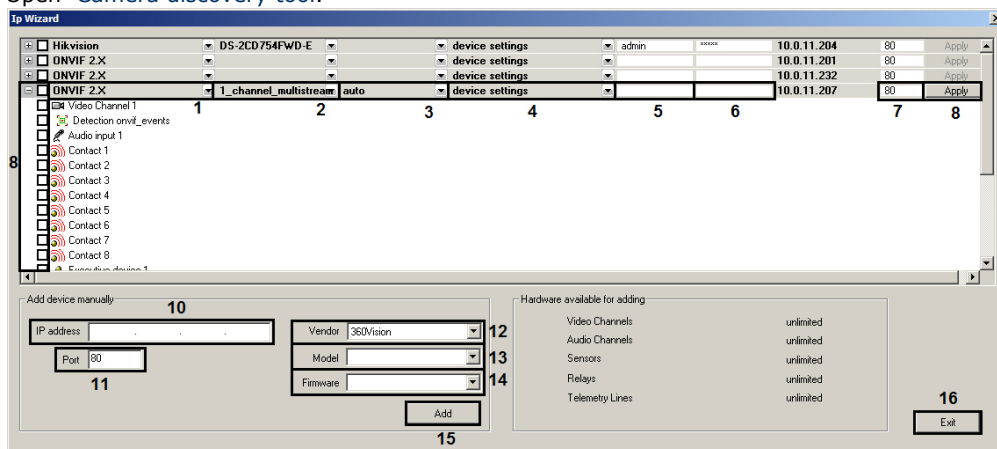

- The discovered ONVIF devices appear in the list. Verify ONVIF or ONVIF 2.X are displayed in the list (1), the correct number of channels for the discovered device is in the list (2) and **auto** (3) in the **Firmware** list. Enter the required value if necessary (by opening the corresponding dropdown list).
- Select **videosever settings** in the dropdown list (4) if settings applied in *Intellect* are to be sent to the camera when it is added or select **device settings** if they are to be in use.
- Enter the user name (5) and password (6) to connect an ONVIF device. The user name and password are given in the documentation for the connected device.
- Verify the TCP/IP port is correct (7). Enter the required value if necessary.

6. Select the objects that are to be created under an ONVIF device by setting the corresponding check boxes checked (8) – see details in [Camera discovery tool](#).
 7. Click the **Apply** button (9).
- The selected objects are automatically created in the object tree in the **Hardware** tab.
8. If an ONVIF device has not been discovered, add it manually.
 - a. Enter the device IP address in the **IP address** field (10).
 - b. Enter TCP/IP port number in the **Port** field (11).
 - c. Select ONVIF or ONVIF 2.X in the **Brand** list (12).



Note.

Select ONVIF 2.X and 1-channel-multistream to use multistream via ONVIF protocol. Video streams of connected ONVIF device are configured in a standard way (see [Configuration of multistream video](#) section of [Administrator's Guide](#)).

- d. Select the number of device channels in the **Model** list (13).
 - e. Select **auto** in the **Firmware** dropdown list (14).
 - f. Click the **Add** button (15).
9. As a result the ONVIF device with specified parameters appears at the top of the window.
 10. To complete creation of ONVIF devices perform steps 2-6 as described above.
 11. Click the **Exit** button to close the **IP Wizard** (16).

An ONVIF device is now created.

Using General Device drivers

General Device is a universal driver that enables AxxonSoft products to work with almost all devices from the relevant manufacturer. General Device drivers are available for Axis, Bosch, Panasonic, Samsung, and Sony IP devices.

Most configuration of General Device-connected cameras is performed via the web interface of the device. A detailed list of supported features is given on the [Documentation Drivers Pack](#) page.

Add a General Device in *Intellect* as follows:

1. Open [Camera discovery tool](#).

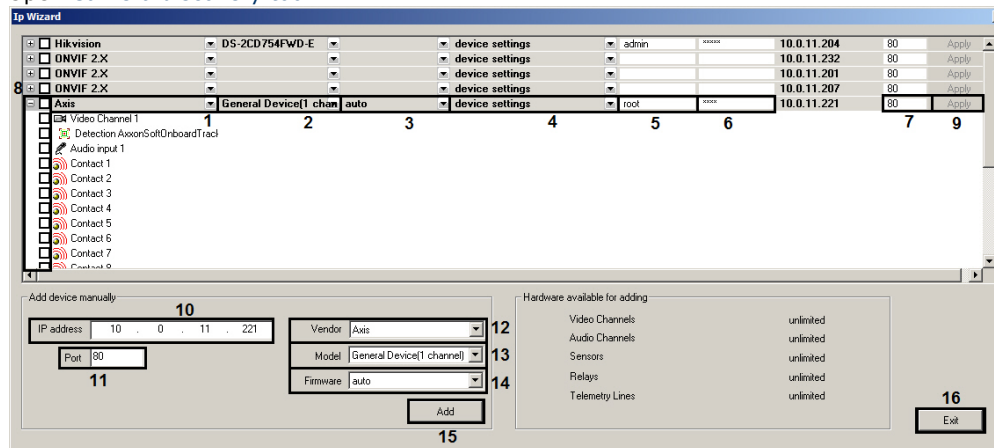

2. The discovered devices appear in the list. Verify the brand has been discovered correctly (1) and make sure that **General Device** is specified in the **Model** list (2) and **auto** (3) in the **Firmware** list. Verify the number of channels on Axis and Bosch devices is correct.

**Note.**

Axis devices are affected by a special restriction: if the user name and password for device access do not equal the default values, the number of channels for the device is not discoverable. Therefore, all non-integrated devices whose user name and password for device access do not equal the default values will be shown in search results as 1-channel General Devices.

3. Select **videosever settings** in the dropdown list (4) if settings applied in *Intellect* are to be sent to the camera when it is added or select **device settings** if they are to be in use.
Keep in mind that settings are changed in the device's web interface.
4. Enter the user name (5) and password (6) to connect an IP device. The user name and password are given in the documentation for the connected device.
5. Verify the TCP/IP port is correct (7). Enter the required value if necessary.
6. Select the objects that are to be created under an IP device by setting the corresponding check boxes checked (8) – see details in [Camera discovery tool](#).
7. Click the **Apply** button (9).
The selected objects are automatically created in the object tree in the **Hardware** tab.
8. If an IP device has not been discovered, add it manually.
 - a. Enter the device IP address in the **IP address** field (10).
 - b. Enter TCP/IP port number in the **Port** field (11).
 - c. Select the brand in the **Brand** list (12).
 - d. In the **Model** field, select **General Device**. For Axis and Bosch devices, select the number of channels on the device (13).
 - e. Select **auto** in the **Firmware** dropdown list (14).
 - f. Click the **Add** button (15).
9. As a result the IP device with specified parameters appears at the top of the window.
10. To complete creation of IP devices perform steps 2-6 as described above.
11. Click the **Exit** button to close the **IP Wizard** (16).

A General Device is now created.

Features of IP device configuration

Features of Beward IP cameras configuration

By default port 80 is set for connecting to IP devices on the settings panel of the **Video Capture Device** object. Enter the **5000** value in the **Port** field to connect to IP device of Beward B-9xx series and B-10xx series (B-975W, B-970, B-915, B2.920, B-1070, B-1014 models and others).

Features of Panasonic IP devices (i-Pro series) configuration

When Panasonic IP-device (i-Pro series) is configured to compress in MPEG4 format, the **Speed** slider controls videodata bitrate on the settings panel of the **Video Capture Device** object. When this parameter is changed, both the speed of video stream and image quality are changed.

**Note**

WV-NP1000\1004, WV-F284, WV-NP240\244, WV-NS202 models and others are IP-devices (i-Pro series).

Video from Panasonic IP device (i-Pro series) is displayed in the **Monitor** interface window with delay from 15 sec to 1 min, depending on the model of the camera.

Features of TrendNet IP device configuration

TrendNet IP device is restarted when one of the following settings is changed on the settings panel of the **Video Capture Device** object and/or **Camera** object:

1. **Speed** parameter(**Video Capture Device**);
2. **Quality** parameter (**Camera**);
3. **Resolution** parameter (**Camera**).

When the changes are saved, video disappears for about 1 min (time depends on the model of the camera) and then it is restored with new parameters.

Note
TrendNet TV-IP312W, TV-IP212W, TV-IP110 and TV-IP410 IP devices are restarted.

Features of Pelco Spectra IV IP device configuration

If Pelco Spectra IV IP device is configured to compress in MPEG4 format, then the **Resolution** dropdown list on the settings panel of the **Camera** object is used for simultaneous configuration of three video signal parameters:

1. **Resolution**;
2. **Speed**;
3. **Compression quality**.

At the same time the **Speed** (**Video Capture Device** object) and **Quality** (**Camera** object) parameters do not interfere with the corresponding parameters of a video signal.

To set maximum quality, resolution and speed select the **Full** or **High** value in the **Resolution** dropdown list on the settings panel of the **Camera** object. The **Standard** value is to be selected to set the lowered compression quality of resolution and speed of video signal.

Features of AEBELL IP device configuration

By default port 80 is set for connecting to IP devices on the settings panel of the **Video Capture Device** object. Specify the **36688** value in the **Port** field to connect to AEBELL BL-E704F IP server.

Features of Dynacolor IP device configuration

Dynacolor DynaHawk ZH-801+ IP device is restarted when one of the following settings is changed on the settings panel of the **Video Capture Device** object and/or **Camera** object:

1. The **Type** parameter (**Video capture device**) – selection of Dynacolor (mjpeg) or Dynacolor (mpeg-4) video stream compression format;
2. The **Speed** parameter (**Video capture device**);
3. The **Quality** parameter (**Camera**);
4. The **Resolution** parameter (**Camera**);

When the changes are saved, video disappears for about 1 min and then it is restored with new parameters.

There can also be no video for about one minute when Intellect is started.

Features of Stream Labs IP device configuration

On the page:

- [Features of Wave Cam M5 camera](#)
- [Features of Wave Server Enterprise hardware internetwork](#)
- [Features of Wave Server WH1501 video server](#)

Note
Detailed description of the given devices can be found at <http://www.ipstreamlabs.ru/products-index.html>

Features of Wave Cam M5 camera

1. Automatic brightness control. In this mode Intellect automatically uses internal algorithm of image's brightness control. This mode is enabled when the **Brightness** slider is set to a minimum position. When there are no special requirements to the image, then this mode of brightness control is recommended.

Note
Brightness can be controlled manually, moving the **Brightness** slider.

2. Video stream frame rate. Wave Cam M5 camera supports two channels of video displaying. When only one video channel is engaged in Intellect, the video stream frame rate is 25 fps. When both channels are engaged, frame rate of video stream for each channel is 12fps.
3. Telemetry. Wave Cam M5 camera is not a PTZ device. One can control some area of an image with the help of video surveillance monitor. While configuring the Telemetry on a Wave Cam M5 camera, do the following:
 - a. Select the protocol of data exchange with a camera - IP-Camera (on the settings panel of the **Telemetry control** object).
 - b. Apply PTZ device to the first video input channel (is set in the **Channel number** list on the settings panel of the **Camera** object).
 - c. Apply telemetry control panel to the first video input channel (is set in the **Channel number** list on the settings panel of the **Camera** object).

Note
The image will move through the second video input channel.

Features of Wave Server Enterprise hardware internetwork

1. Video stream frame rate. When only one camera is connected to Wave Server Enterprise hardware internetwork, the video stream frame rate is 25 fps. When two or more cameras are connected, total frame rate of processed video is 16 fps.

Note
If two video input channels are used, then frame rate of processed video is $16/2=8$ fps. If there are four video input channels, then $16/4=4$ fps

2. Telemetry. Telemetry is performed on an individual card with its own network interface. To configure it, do the following:
 - a. Select the protocol of data exchange with camera with the help of which an analog camera connected to the video server is controlled on the settings panel of the **Telemetry control** object (for example, Pelco-D, Pelco-P, Panasonic-850).
 - b. Create two **Video Capture Device** objects.

Note
For every analog camera connected to Wave Server Enterprise, two **Camera** objects are to be created under different **Video Capture Device** objects for video viewing and telemetry configuration correspondingly.

Features of Wave Server WH1501 video server

Telemetry. When telemetry for Wave Server WH1501 video server is configured, it is necessary to select protocol with the help of which the analog camera connected to the video server is controlled, on the settings panel of the **Telemetry control** object (for example, Pelco-D, Pelco-P, Panasonic-850).

Features of Cisco IP device configuration

Cisco 4500 IP-device supports the following formats of video signal compression:

1. H.264;
2. MJPEG.

While setting the resolution the H.264 format has a higher priority than MJPEG: a possibility to set the resolution for MJPEG exceeding the given for H.264, is not provided.

Priority difference leads to the following effects:

1. After changing the video capture card of the **Cisco(h264)** type for **Cisco(mjpeg)** with standard video resolution, MJPEG video resolution can not be increased;
2. When the video capture card of the **Cisco(mjpeg)** type is changed for **Cisco(h264)** with full video resolution, the resolution will be changed from 704*576 to 1280*720. Resolution 720*576 will be set after return to the **Cisco(mjpeg)** type.

Note
The type of a video capture card is selected in the **Type** dropdown list on the settings panel of the **Video Capture Device** object. Video resolution is set with the use of the same parameter on the settings panel of the **Camera** child object.

Features of Mobotix IP device configuration

Mobotix IP camera supports the following formats of video compression in Intellect:

1. MJPEG;
2. MxPEG.

Audio subsystem of Mobotix IP devices may be used when video is encoded in MxPEG. To choose this format, select the **Mobotix MxPEG** value in the **Type** list on the settings panel of the **Video Capture Device** object.

Note
When the **Mobotix** value is selected, video is received in MJPEG format and audio subsystem functionality of IP device is not performed.

Note
Mobotix IP cameras that support sound are Q24M, D12, M22 and others. Detailed description of these devices can be found at <http://www.mobotix.com>

Note.
If MxPEG codec and MxPEG decompressor are in use, then video can be not displayed in *Intellect*. In this case the value of the MxpegResetCounter registry key should be lowered MxpegResetCounter, specified by default – see [Registry keys reference guide](#).

Characteristics of joint operation of Jassun and Bosch cameras

Some errors can appear while the Bosch camera working if the ActiveX add-on is installed for the Jassun camera.

Note.
This add-on is provided to the installation while entering the camera web-interface.

Changing the transport protocol used by IP-device

INTELLECT™ provides an opportunity to change the transport protocol used by the IP-device. The following types of protocols can be used:

1. **TCP-based protocols.**
This protocol is reliable; safety and reliability of data delivery is provided when used at the network layer of the operating system. On the other hand, this is its fault: the packet loss will cause re-sending the data. This requires substantial additional resources and time in order to determine the loss and send the data again.

Recommended for use:

- a. In busy networks where serious packet loss are possible (caused by the equipment, communication media, etc.).
- b. When the integrity of the picture is more important than speed of response (for example, when recording to the archive).

Not recommended for use:

- a. In the high-bit-rate stream (high fps and resolution, low compression).
- b. For situations where a delay between the true and the observed picture is more important than the loss of a picture (for example, live video).

Some cameras (for example, ArecontVision) have serious FPS limitations when TCP protocol is in use.

2. **UDP-based protocols.**

These protocols are "unreliable", i.e. transport layer does not provide data delivery for them. On the other hand, this protocol provides a fast data transmission and low delay. Also, in case of low losses and high fps the picture is smoother.

Moreover, some UDP protocols, particularly RTP, have packet losses processed at the application layer (i.e., means of application, rather than the OS). This allows using algorithms of adjustment stream width and packet loss processing that are fitted for multimedia transmission. So sometimes these protocols better solve the problem of bad data transmission in networks.

Recommended for use:

- a. In networks with low packet loss (in-door, office network).
- b. For situations where a delay between the true and the observed picture is more important than the loss of a picture (for example, live video).
- c. In the high-bit-rate stream (high fps and resolution, low compression).

Not recommended for use:

- a. In busy networks where serious packet loss are possible (because of the equipment, communication media, etc.).
- b. When the integrity of the picture is more important than speed of response (for example, when recording to the archive).



Note.

INTELLECT™ does not support IP devices over https protocol.

In order to change the transport protocols for IP device, add the following key to the registry:

1. Path: HKEY_LOCAL_MACHINE \SOFTWARE\ITV\Intellect\Video\TransportProtocols (for 64-bit system the path is HKEY_LOCAL_MACHINE\SOFTWARE\Wow6432Node\ITV\Intellect\Video\TransportProtocols). If the path does not exist, then create the corresponding section.
- 2.

Key name: <Driver name>. The driver name, not the name of the IP-device vendor, is used as name of the key. Name of the driver is included in the name of the corresponding ipd-file which is located in the installation directory of Drivers Pack (for example, the file C:\Program Files\Common Files\AxxonSoft\Ipint.DriverPack\3.0.0\Ipint.Axis.ipd for Axis devices). In most cases, the driver name matches the name of the IP-device vendor. To clarify the driver name for the desired vendor contact AxxonSoft technical support.



Note.

If IP-device is connected via RTSP, use the name of the key "RTSP" without quotes, the value is case sensitive.

3. Value: <protocol>. For example, "http" (TCP-based) or "tftp" (UDP-based) for ArecontVision, "tcp" or "udp" for Axis. The key value is case sensitive.



Note.

For some Axis devices it is possible to enable multicast in the device. The IP-device will be the source of broadcasting. Set the "multicast" value to the Axis parameter to enable broadcasting. On the moment of document writing this feature is supported by the following models of Axis cameras: 243SA, 243Q, 241Q, 232D+, 225FD, 221, 216FD and 211A.

4. Key type: string value.

Digest authentication when accessing IP device

Intellect supports safe digest authentication (Digest HTTP authentication) when accessing IP device. To perform this type of authentication it is to be supported by the IP device.

Note.
Information whether the IP device supports digest authentication can be found at the vendor's website.

For Intellect to use the IP device via digest authentication only, one is to add ":" as the last character when adding the IP device manually (by creating the **Camera** object) or using the IP Wizard.

For instance, if the camera access password is *root* and the camera supports digest authentication, then *root: password* is to be specified.

Configuring Sensor-Relay devices in INTELLECT™ software

Creating and configuring the Relay system object

The **Relay** system object is created under the **Video Capture Device** object.

The **Relay** object is created and main parameters are set in the following order:

1. Go to the **Hardware** tab in the settings panel of *INTELLECT™* (1).
2. Create the **Relay** system object under the **Video Capture Device** object or select the corresponding object in the object tree in the **Hardware** tab on the settings panel of *INTELLECT™* (2).

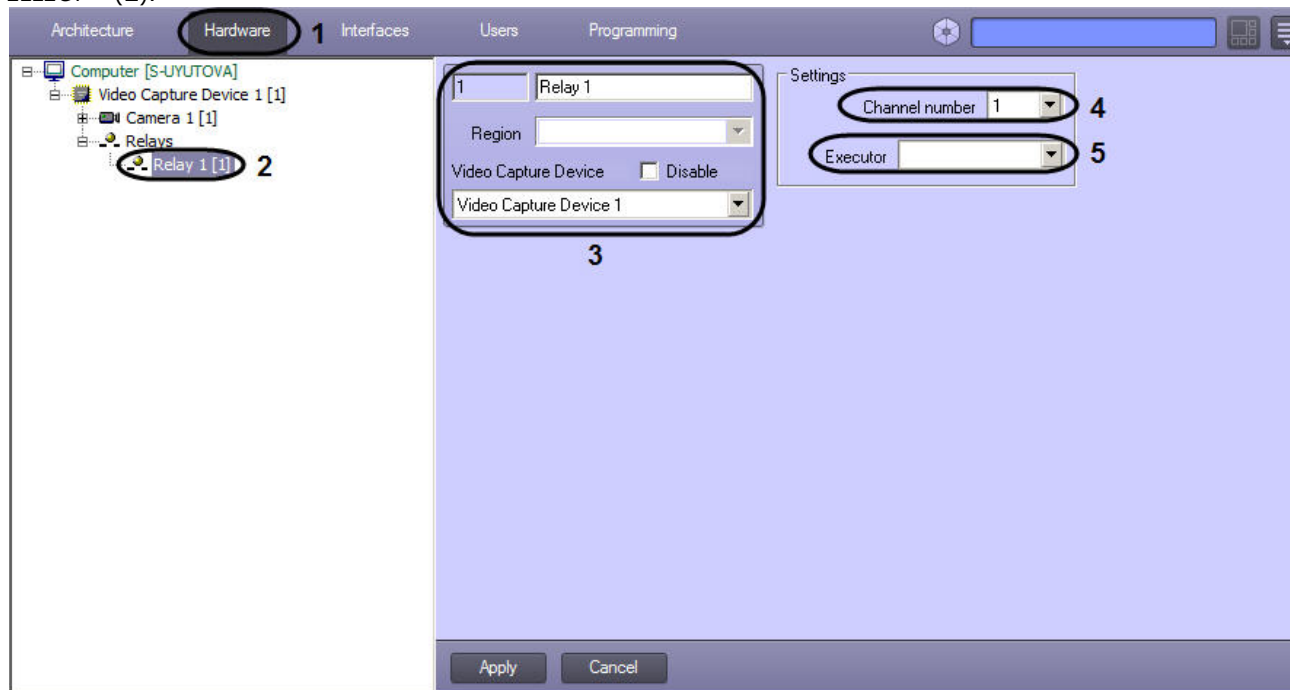

3. Specify the ID and name of the **Relay** object and select the **Video Capture Device** object to become the parent of the **Relay** object (3).

**Note**

If the Sensor-Relay card is used, then specify that video capture card with ADC to which the Sensor-Relay card is connected.

4. Select the **Channel number** matching the number of output connector to which the relay is connected (4).
5. In the **Executor** dropdown list select the type of executive device used as the relay in the guarded area (5).
The **Executor** parameter is used for selecting the icon on the interactive map. This parameter is essential for better perception of information (displayed on the map as object icons) by Operator and for real-time intercepting by Operator if required.
The types of executive devices available for the **Relay** system object are given in table.

Executive device	Description
Light	Icon of the interactive map for the device responding to changes in the illumination in the guarded area
Signal	Icon of the interactive map for the device responding to sound changes in the guarded area
Lock	Icon of the interactive map for the device responding to locking/unlocking a window, door, etc.

6. Click the **Apply** button to save the changes.

Creating and configuring the **Relay** system object is completed.

Creating and configuring the Sensor system object

The **Sensor** system object is created under the **Video Capture Device** object.

The **Sensor** object is created and main parameters are set in the following order:

1. Go to the **Hardware** tab in the settings panel of *INTELLECT™* (1).
2. Create the **Sensor** system object under the **Video Capture Device** object or select the corresponding object in the object tree in the **Hardware** tab on the settings panel of *INTELLECT™* (2).

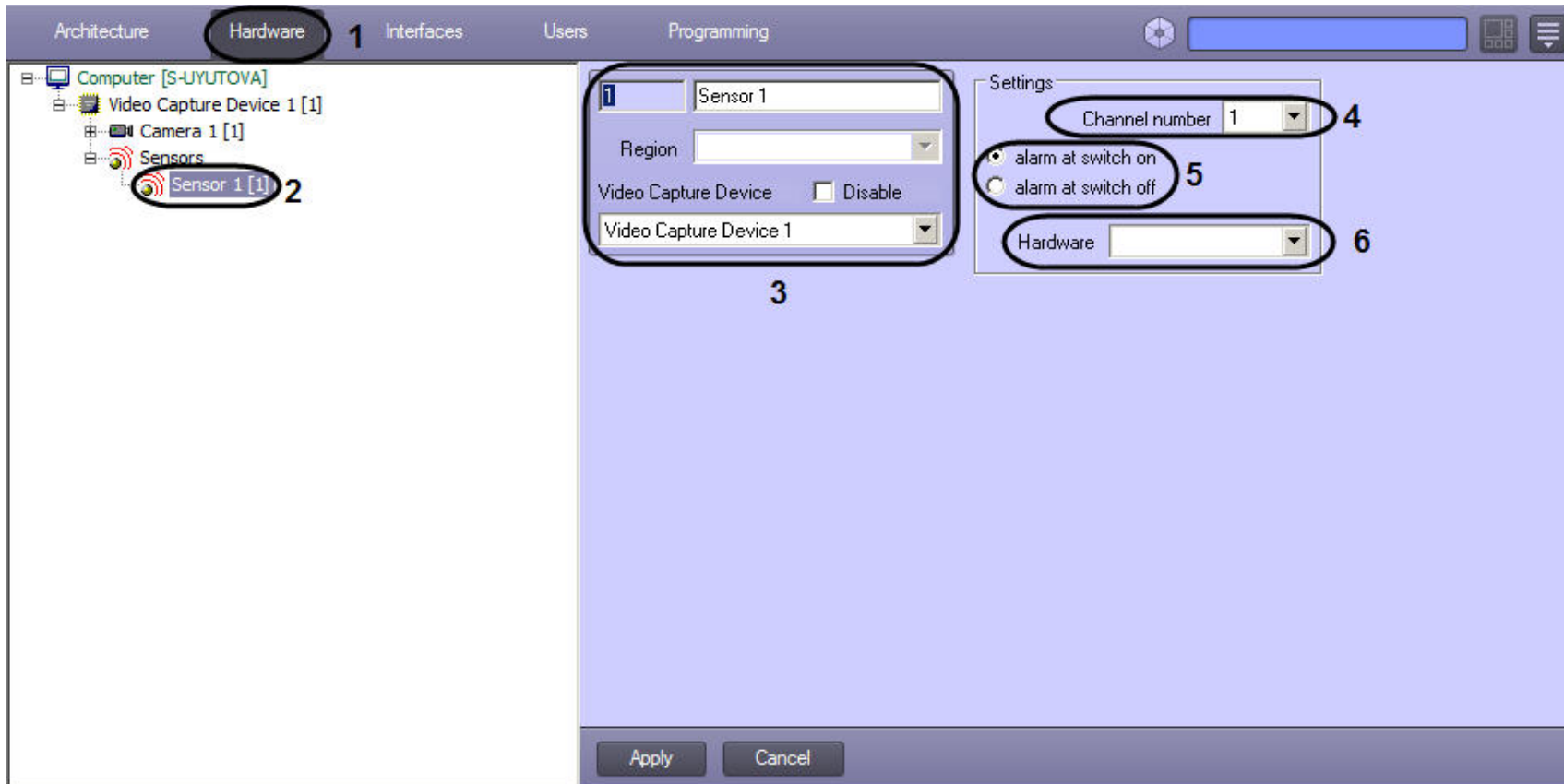

3. Specify the ID and name of the **Sensor** object and select the **Video Capture Device** object to become the parent of the **Sensor** object (3).

Note
If the Sensor-Relay card is used, then specify that video capture card with ADC to which the Sensor-Relay card is connected.

4. Select the channel number matching the number of output connector to which the sensor is connected (4).
5. In the group of switches select the alarm mode: at switch on or at switch off. By default the **alarm at switch on** mode is selected (5).
The executive device corresponding to the **Sensor** system object operates at one of modes: **alarm at switch on** or **alarm at switch off**.

Note
Sensors connected to Panasonic IP-devices (i-Pro series) trigger only at switch off.

When the **alarm at switch off** mode is selected, the normal state of the sensor is open. When the sensor closes, it triggers and the corresponding actions are performed in INTELLECT™.
6. In the **Hardware** dropdown list select the type of executive device used as the detector in the guarded area (6).

The **Hardware** parameter is used for selecting the icon on the interactive map. This parameter is essential for better perception of information (displayed on the map as object icons) by Operator and for real-time intercepting by Operator if required. Types of detectors available for the **Sensor** system object are given in table.

Hardware	Description
Infrared	Icon of the interactive map for the motion detectors
PIR	Icon of the interactive map for the device on the ceiling of the guarded area
Glass	Icon of the interactive map for the device on the window of the guarded area responding when the window is broken
Fire	Icon of the interactive map for the device responding to changes of heat conditions in the guarded area
Window	Icon of the interactive map for the device installed some distance away the window and responding when the window is broken
Smoke	Icon of the interactive map for the device responding to smoke in the guarded area
Reed switch	Icon of the interactive map for the device responding to locking/unlocking a window, door, etc.

7. Click the **Apply** button to save the changes.

When the Sensor is created in the objects tree, it is in the "Armed" state. To change the Sensor state, use a macro (see the [Creating and using macros](#) section) or control the Sensor on the Map (see the [Configuring the interactive map for object state indication and controlling the objects](#) and [Operations with sensors](#) sections). If the Sensor is armed, then at the Sensor switching on / off the "Alarm" event appears depending on the alarm mode setting - see step 5 above. If the Sensor is disarmed, the "Closed" / "Opened" events appear correspondingly.

Creating and configuring the **Sensor** system object is completed.

Configuring Sensor-Relay expansion cards

How to configure relay connection

If relays are connected to the Sensor-Relay card, then up to 4 **Relay** objects can be created under the **Video Capture Device** parent object.

All the **Relay** objects corresponding to relays connected to one Sensor-Relay card are to be created in the **Hardware** object tree under the **Video Capture Device** object corresponding to the video capture card where the Sensor-Relay card is installed.

At least one **Camera** object is to be created under the same **Video Capture device** object for relay to work.

If the Sensor-Relay card is installed on FS-5, FS-6 or FS-16 video capture card, then the **Relay** objects are to be created under any **Video Capture Device** object within the hardware card.

If the Sensor-Relay card is installed on SC3B0N16 (WS216) video capture card, then the **Relay** objects are to be created under the **Video Capture Device** object with **04** value of the PCI-channel.

If the Sensor-Relay card is installed on FS-8 video capture card, then the **Relay** objects are to be created under the **Video Capture Device** object with **07** value of the PCI-channel.

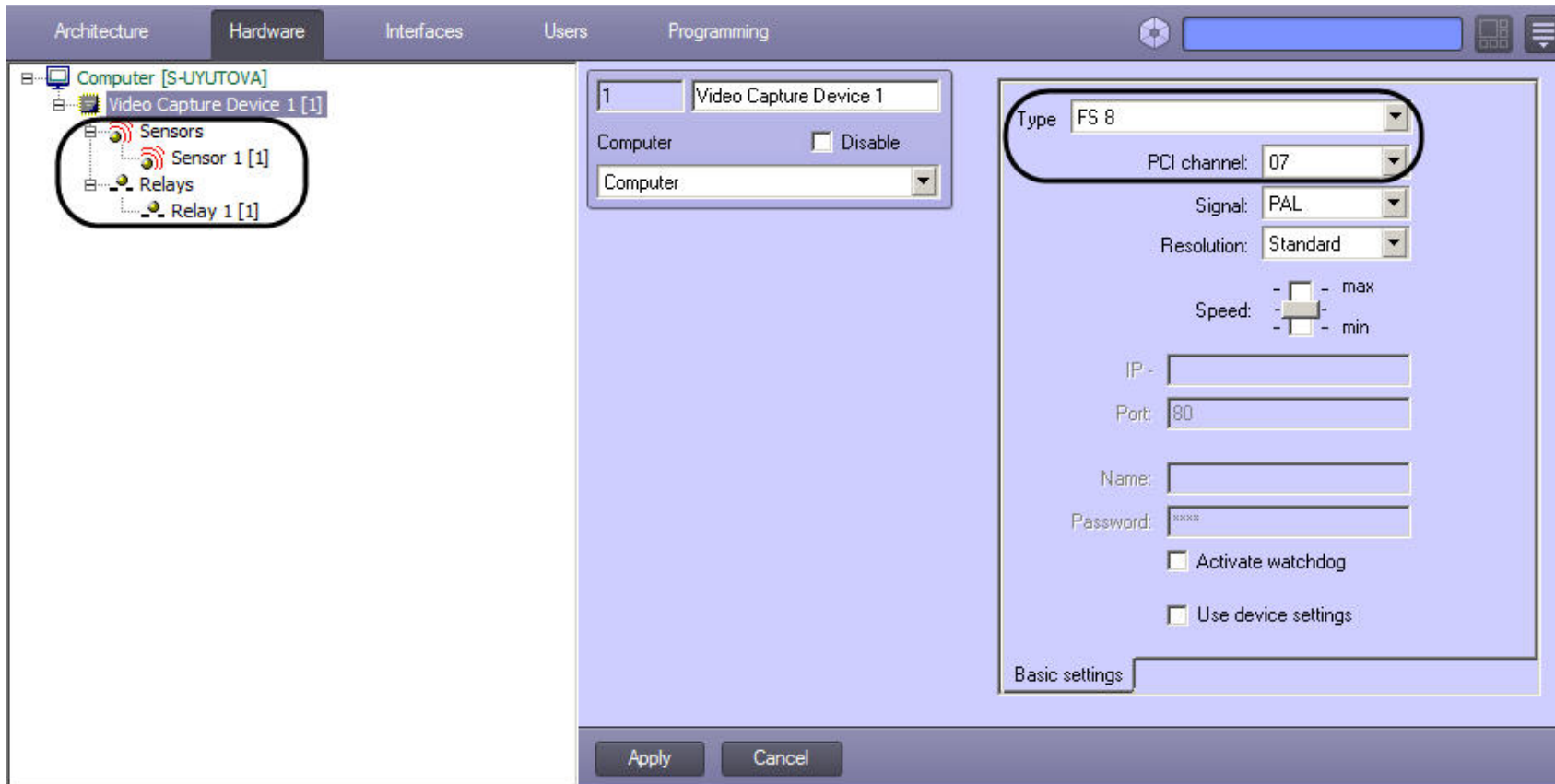

Relay objects can be relocated in the object tree. To change the parent **Video Capture Device** object of the **Relay** objects, change the value of the **Video Capture Device** object on the settings panel of the **Relay** object. The value of this parameter is to correspond to the number of the **Video Capture Device** object (in the object tree) under which the **Relay** object is to be located. If the value of the **Video Capture Device** parameter is changed on the settings panel of the **Relay** object, then the object is moved to the branch of child objects of the corresponding **Video Capture Device** object.

Note
 All **Relay** objects related to one Sensor-Relay card are to be located in child branches under the same **Video Capture Device** object for proper operation of *INTELLECT™*. The **Relay** objects are not to be located under different **Video Capture Device** objects even if these objects represent the same video capture card with the adjustable Sensor-Relay card.

The next figure shows an example of locating the **Relay** objects in the object tree when two FS-6 (or FS-16) video capture cards with 4 relays connected to the first 4/4 (or 16/4) Sensor-Relay card and 2 relays connected to the second one are used.

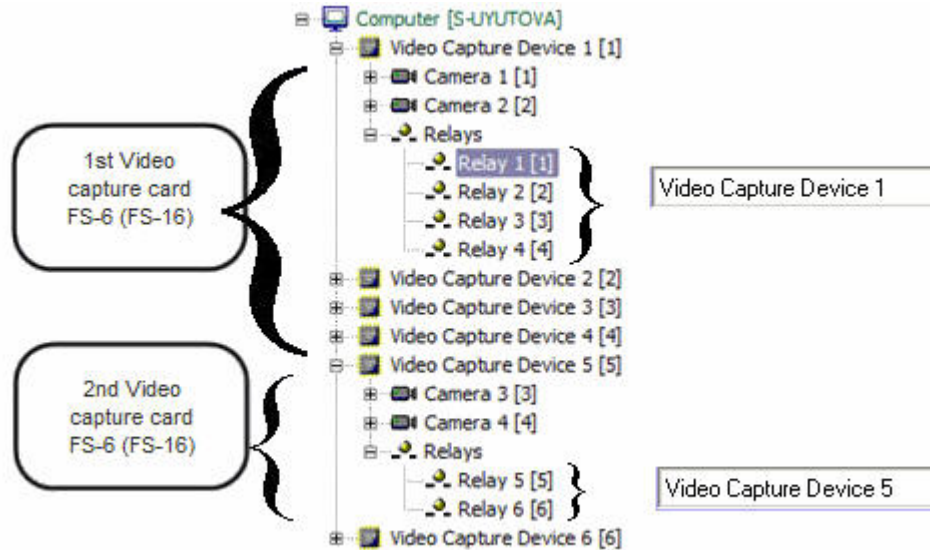

Configuring the **Relay** objects one is to specify the channel numbers of sensor connection to the Sensor-Relay card according to the numbers of the DO pins on the card.

To change the channel numeration, use the **Channel Number** list on the settings panel of the **Relay** object.

The 4/4 and 16/4 Sensor-Relay cards allow connecting up to 4 relay channels according to the license key file.

The figure below shows an example of the channel numeration configuration of 4 relays connected to one 4/4 Sensor-Relay card installed on FS-6 (or FS-16) video capture card (4 ADCs for 4 **Video Capture Device** objects).



Channels of the second 16/4 Sensor-Relay card are numbered 1-4 according to input connectors.

Example of the channel numeration configuration of relays connected on the second (next) 16/4 Sensor-Relay card installed on FS-6 (or FS-16) video capture card (4 ADCs for 4 **Video Capture Device** objects):

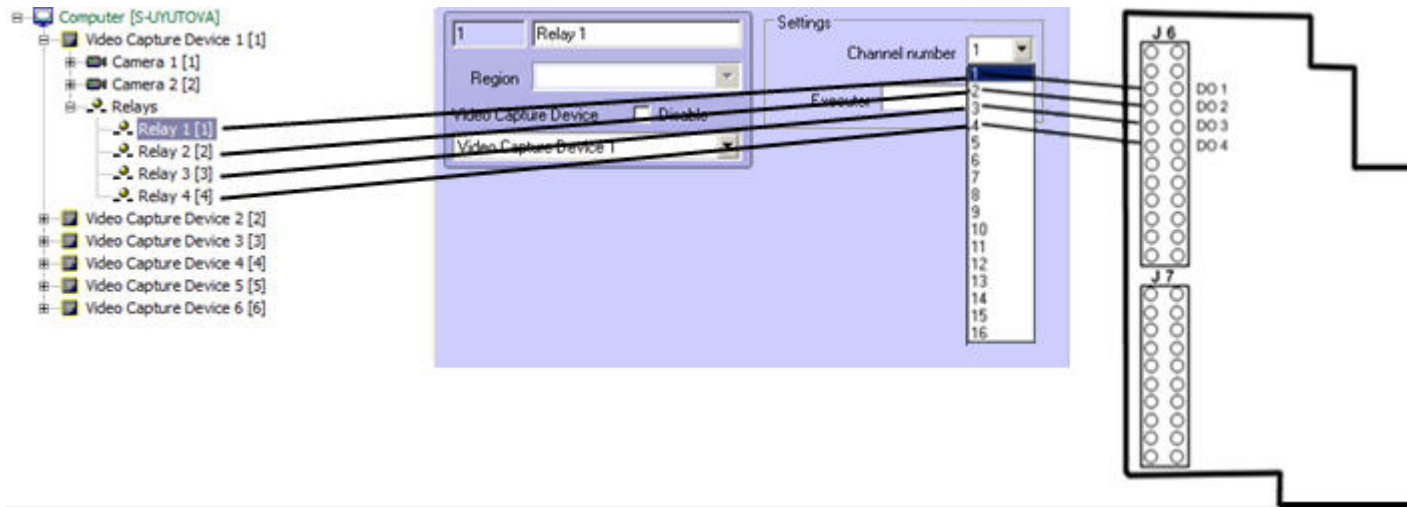

How to configure sensor connection using 4/4 Sensor-Relay card

One can create up to 4 **Sensor** objects under the **Video Capture Device** object when 4/4 Sensor-Relay card is installed.

All the **Sensor** objects corresponding to sensors connected to one 4/4 Sensor-Relay card are to be created in the **Hardware** object tree under the **Video Capture Device** object corresponding to the video capture card where the Sensor-Relay card is installed.

At least one **Camera** object is to be created under the same **Video Capture device** object for sensor to work.

If the Sensor-Relay card is installed on FS-5, FS-6 or FS-16 video capture card, then the **Sensor** objects are to be created under any **Video Capture Device** object within the hardware card.

If the Sensor-Relay card is installed on SC3B0N16 (WS216) video capture card, then the **Sensor** objects are to be created under the **Video Capture Device** object with **00** value of the PCI-channel.

If the Sensor-Relay card is installed on FS-8 video capture card, then the **Sensor** objects are to be created under the **Video Capture Device** object with **07** value of the PCI-channel.

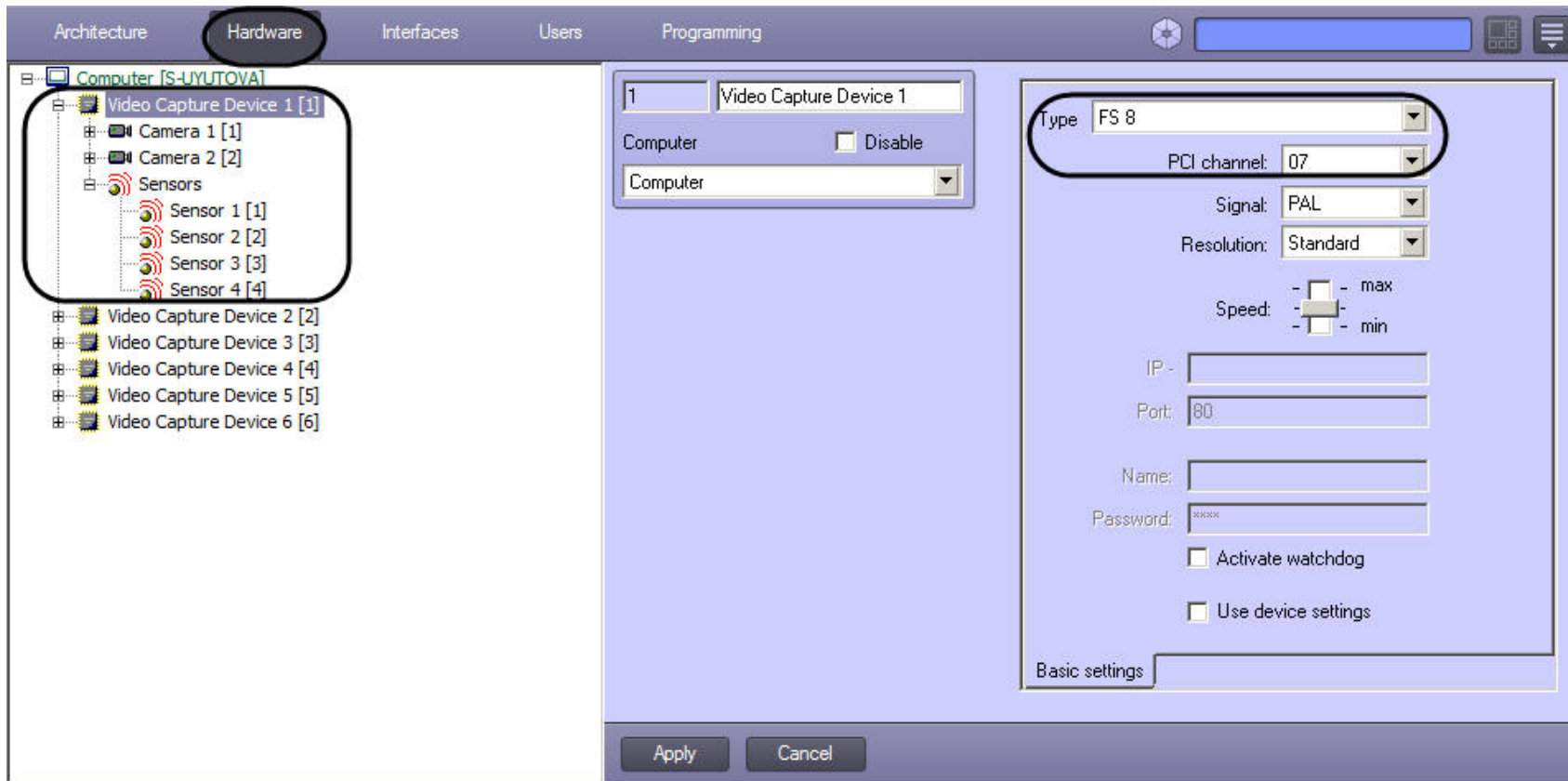

Sensor objects can be relocated in the object tree. To change the parent **Video Capture Device** object of the **Sensor** objects, change the value of the Video Capture Device object on the settings panel of the **Sensor** object. The value of this parameter is to correspond to the number of the **Video Capture Device** object (in the object tree) under which the **Sensor** object is to be located. If the value of the **Video Capture Device** parameter is changed on the settings panel of the **Sensor** object, then the object is relocated to the branch of child objects of the corresponding **Video Capture Device** object.

Note
All **Sensor** objects related to one Sensor-Relay card are to be located in child branches under the same **Video Capture Device** object for proper operation of *INTELLECT™*. The **Sensor** objects are not to be located under different **Video Capture Device** objects even if these objects represent the same video capture card with the adjustable Sensor-Relay card.

The next figure shows an example of locating the **Sensor** objects in the object tree when two FS-6 (or FS-16) video capture cards with 4 sensors connected to the first 4/4 Sensor-Relay card and 2 sensors connected to the second one are used.

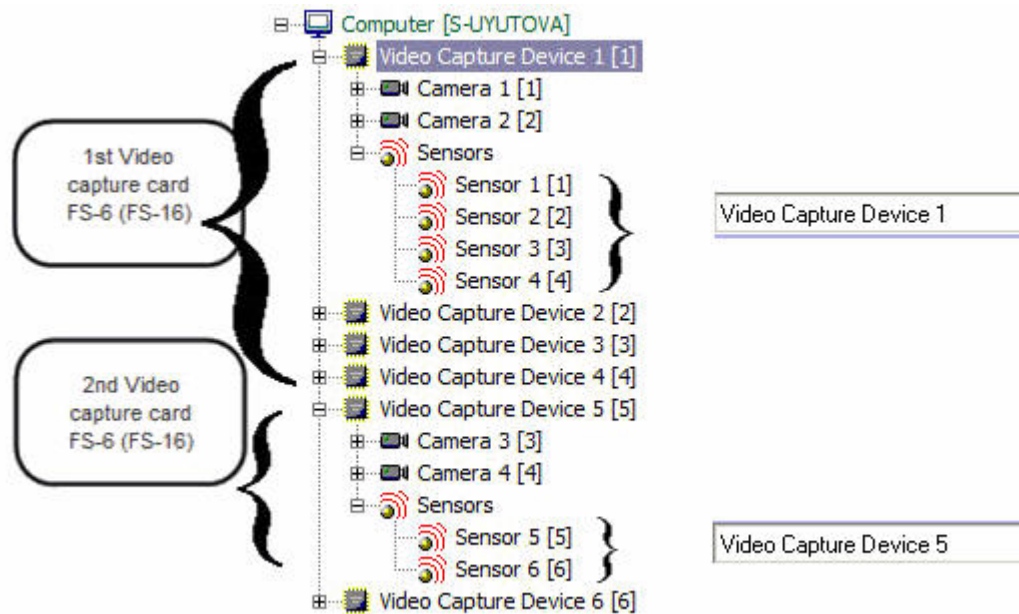

When configuring the **Sensor** objects one is to specify the channel numbers of sensor connection to the Sensor-Relay card according to the numbers of the input connectors.

To change the channel numeration, use the **Channel Number** list on the settings panel of the **Sensor** object.

The 4/4 and 16/4 Sensor-Relay cards allow connecting up to 4 sensor channels according to the license key file.

The next figure shows an example of the channel numeration configuration of 4 sensors connected to one 4/4 Sensor-Relay card installed on FS-6 (or FS-16) video capture card (4 ADCs for 4 **Video Capture Device** objects):

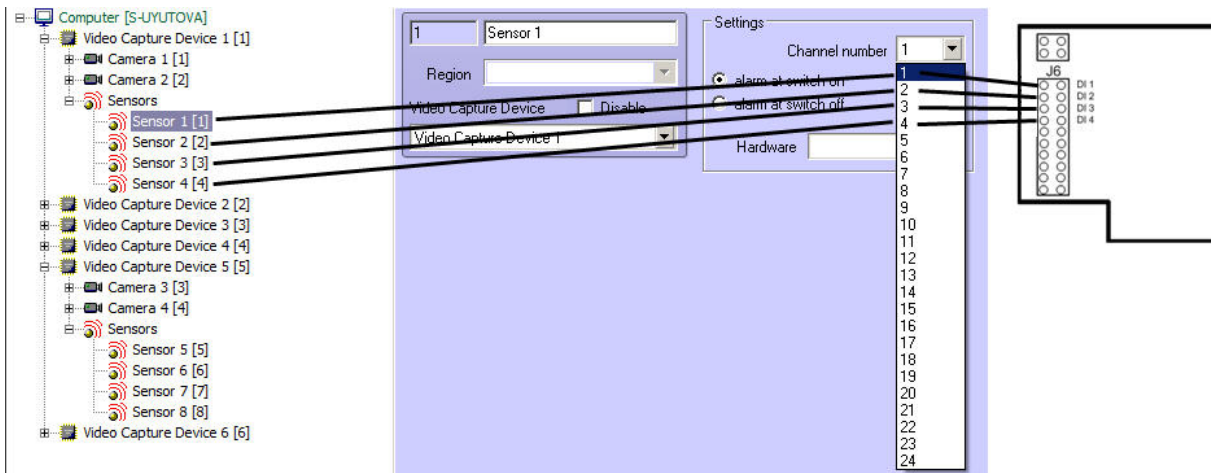

Channels of the second 4/4 Sensor-Relay card are numbered 1-4 according to input connectors.

Example of the channel numeration configuration of sensors connected on the second (next) 4/4 Sensor-Relay card installed on FS-6 (or FS-16) video capture card (4 ADCs for 4 **Video Capture Device** objects):

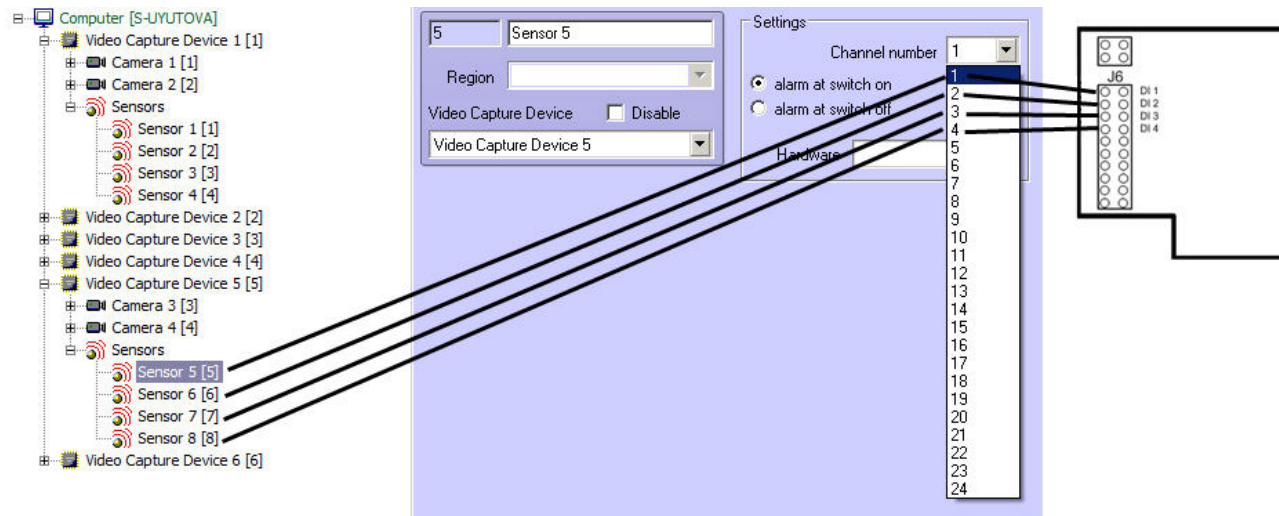

How to configure sensor connection using 16/4 Sensor-Relay card

One can create up to 16 **Sensor** objects under the **Video Capture Device** object when 16/4 Sensor-Relay card is installed.

All the **Sensor** objects corresponding to sensors connected to one 16/4 Sensor-Relay are to be created in the **Hardware** object tree under the **Video Capture Device** object corresponding to the video capture card where the Sensor-Relay card is installed.

At least one **Camera** object is to be created under the same **Video Capture device** object for sensor to work.

If the Sensor-Relay card is installed on FS-5, FS-6 or FS-16 video capture card, then the **Sensor** objects are to be created under any **Video Capture Device** object within the hardware card.

If the Sensor-Relay card is installed on FS-8 video capture card, then the **Sensor** objects are to be created under the **Video Capture Device** object with **07** value of the PCI-channel.

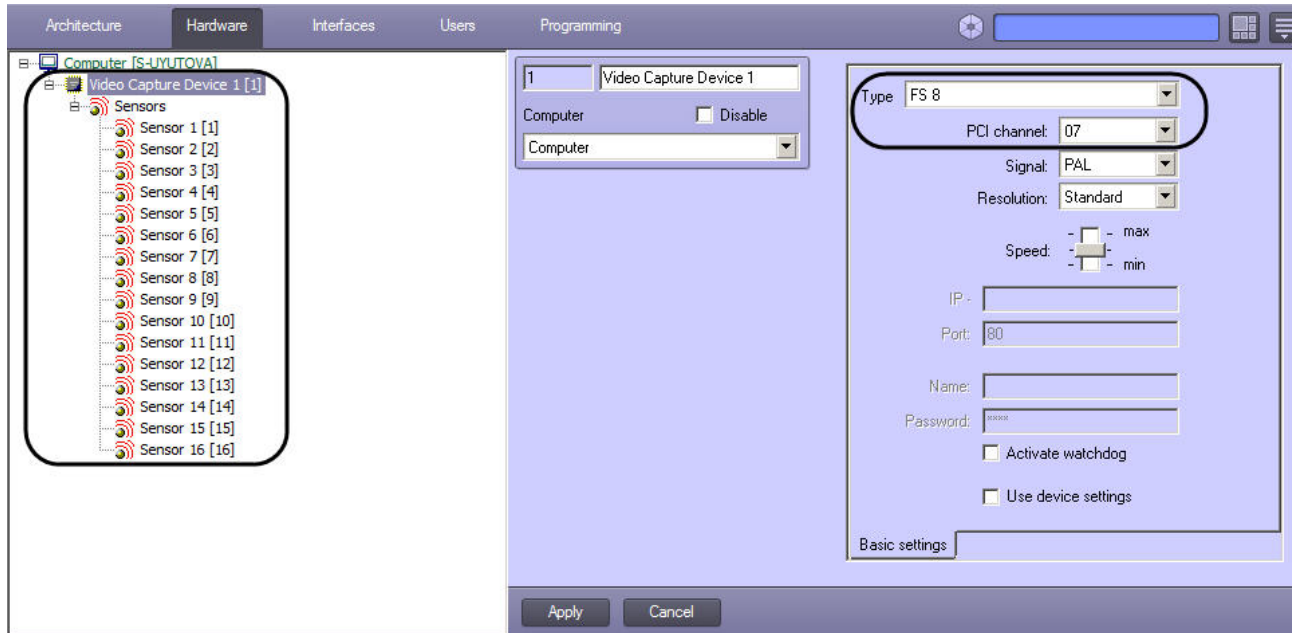

Sensor objects can be relocated in the object tree. To change the parent **Video Capture Device** object of the **Sensor** objects, change the value of the **Video Capture Device** object on the settings panel of the **Sensor** object. The value of this parameter is to correspond to the number of the **Video Capture Device** object (in the object tree) under which the **Sensor** object is to be located. If the value of the **Video Capture Device** parameter is changed on the settings panel of the **Sensor** object, then the object is relocated to the branch of child objects of the corresponding **Video Capture Device** object.

The figure below shows an example of locating the **Sensor** objects in the object tree when two FS-6 (FS-16) video capture cards with 16 sensors connected to the first 16/4 Sensor-Relay card and 2 sensors connected to the second one are used.

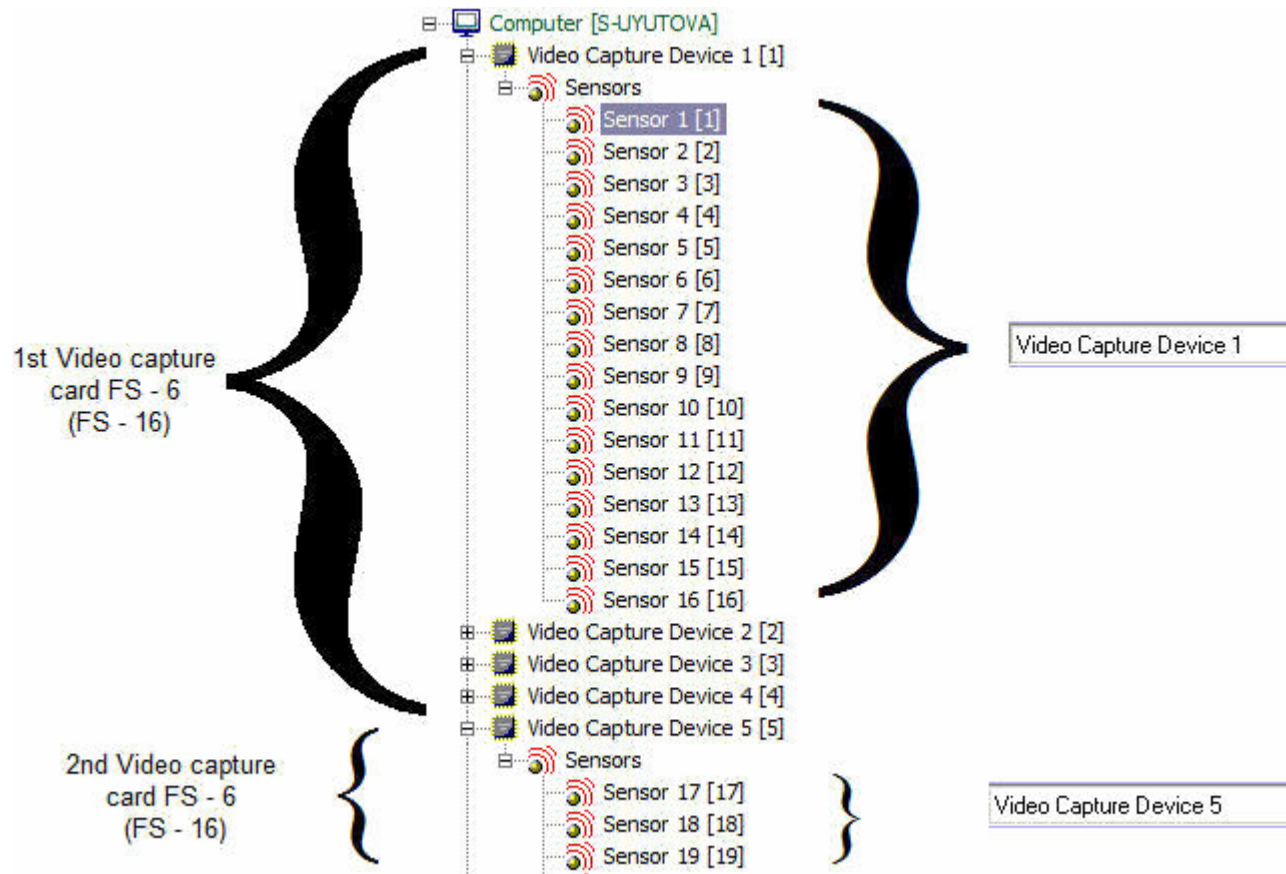

When configuring the **Sensor** objects one is to specify the channel numbers of sensor connection to the Sensor-Relay card according to the numbers of the input connectors.

To change the channel numeration, use the **Channel Number** list on the settings panel of the **Sensor** object.

The 16/4 Sensor-Relay cards allow connecting up to 4 sensor channels according to the license key file.

The figure below shows an example of the channel numeration configuration on the 16/4 Sensor-Relay card installed on FS-6 (or FS-16) video capture card (4 ADCs for 4 **Video Capture Device** objects):

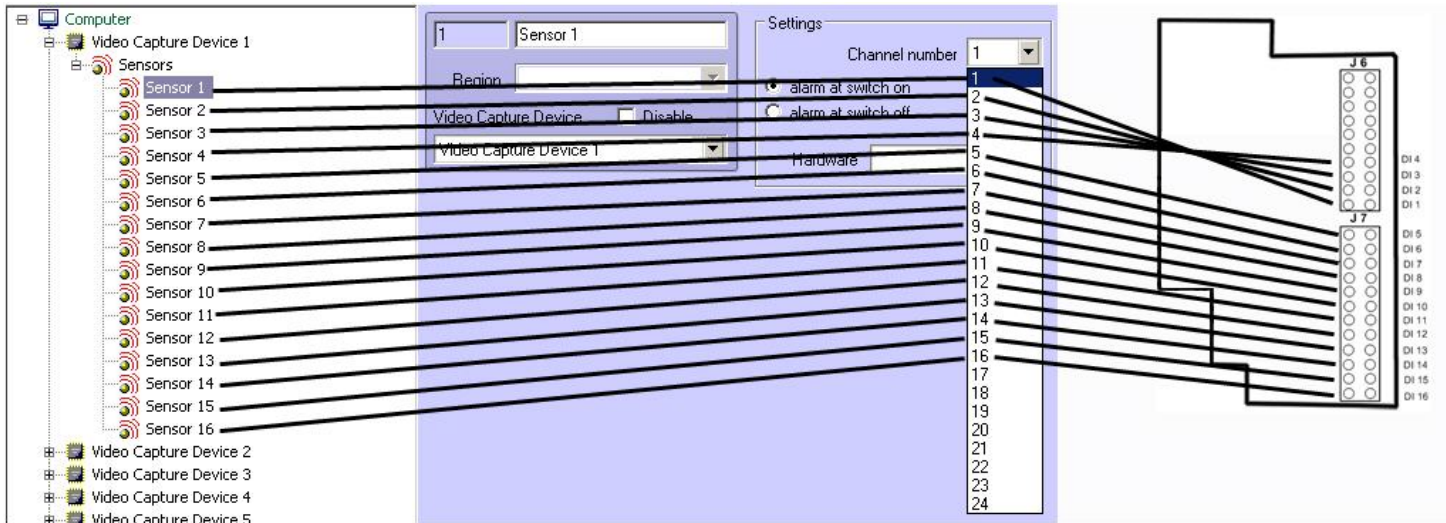

Channels of the second 16/4 Sensor-Relay card are numbered 1-16 according to input connectors.

Example of the channel numeration configuration of sensors connected on the second (next) 16/4 Sensor-Relay card installed on FS-6 (or FS-16) video capture card (4 ADCs for 4 **Video Capture Device** objects):

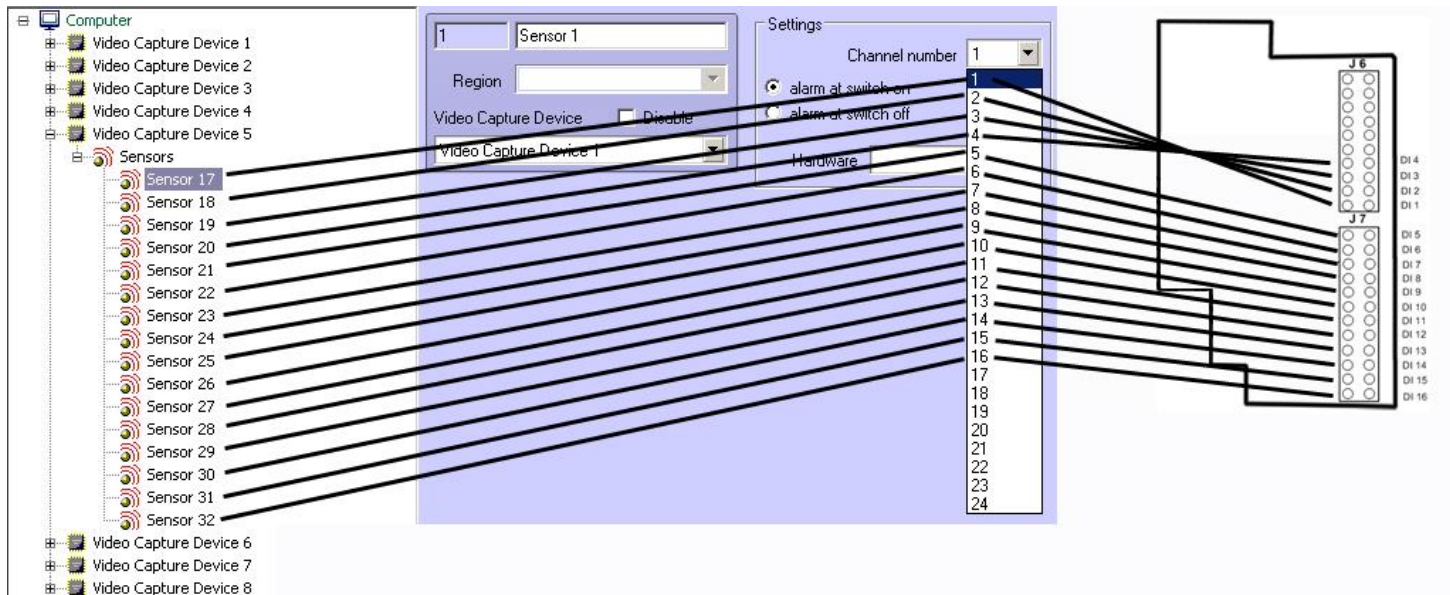

Configuring Sensor-Relay expansion cards (low profile)

Connecting relays of 4/4 Sensor-Relay expansion cards (low profile)

Depending on what video capture card is in use, the **Relay** objects corresponding to relays connected to 4/4 Sensor-Relay card (low profile) are created under the **Video Capture Device** objects of one of the following types: **SC200Q4 Low profile (FS 115)**, **SC300Q16 (FX 4)**, **SC300D16 (FX 8)**, **SC310N16 (FX 16)**, **SC3B0N16 (WS 216)**, **SC230N4** and **SC590N4**.

At least one **Camera** object is to be created under the same **Video Capture device** object for relay to work.

The **Relay** objects are to be created under the **Video Capture Device** object that has the first PCI channel. E.g., when building security video subsystem with the use of two SC300Q16 (FX4) and two Sensor-Relay cards (low profile) the **Relay** objects are to be created under the **Video Capture Device** objects with **00** (for the first SC300Q16 (FX4) card) and **04** (for the second SC300Q16 (FX4) card) values of PCI channels.

If the 4/4 Sensor-Relay card (low profile) is installed on SC3B0N16 (WS216) video capture card, then the **Relay** objects are to be created under the **Video Capture Device** object with **04** value of the PCI-channel.

For SC310N16 (FX16) video capture card the **Relay** objects can be created under the **Video Capture Device** object with 00 or 08 value of PCI channel. Working channel is discovered experimentally.

For SC230N4 video capture card the **Relay** objects are to be created under the **Video Capture Device** object with 03 value of PCI channel.

For SC590N4 card **Relay** objects can be created under the **Video Capture Device** object with number of PCI-channel equal to **01** (see [Connecting 4/4 Sensor-Relay \(low profile\) cards](#) section for Sensor-Relay cards connected to low contacts of J2 connector of CS590N4 card) and to **03** (for Sensor-Relay card connected to top contacts of J2 connector of SC590N4 card). If the SC590N4 card is in use do not create not more than 4 **Relay** objects for one **Video Capture Device** object.

 **Note**
Number of PCI channels (number of the **Video Capture Device** objects) for all types of cards is given in [Features of video subsystem configuration](#) section.

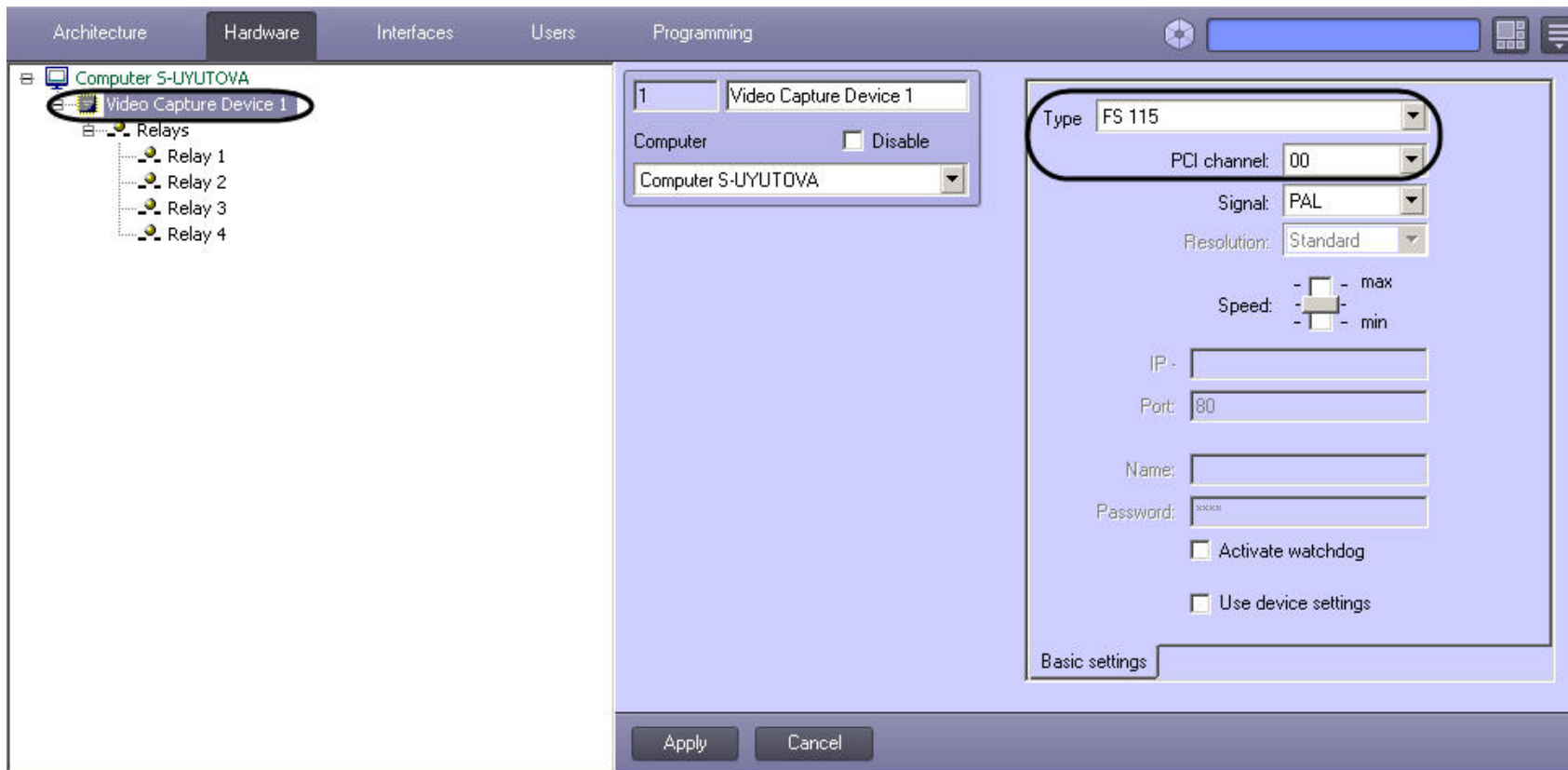

One can create up to 4 **Relay** objects under the **Video Capture Device** object. When configuring the **Relay** objects one is to specify the channel numbers of relay connection to 4/4 Sensor-Relay card (low profile) according to external pinout of the card.

To change the channel numeration, use the **Channel Number** list on the settings panel of the **Relay** object.

4/4 Sensor-Relay card (low profile) allows connecting up to 4 relay channels according to the license key file.

The figure below shows an example of the channel numeration configuration of 4 relays connected to one 4/4 Sensor-Relay card (low profile).

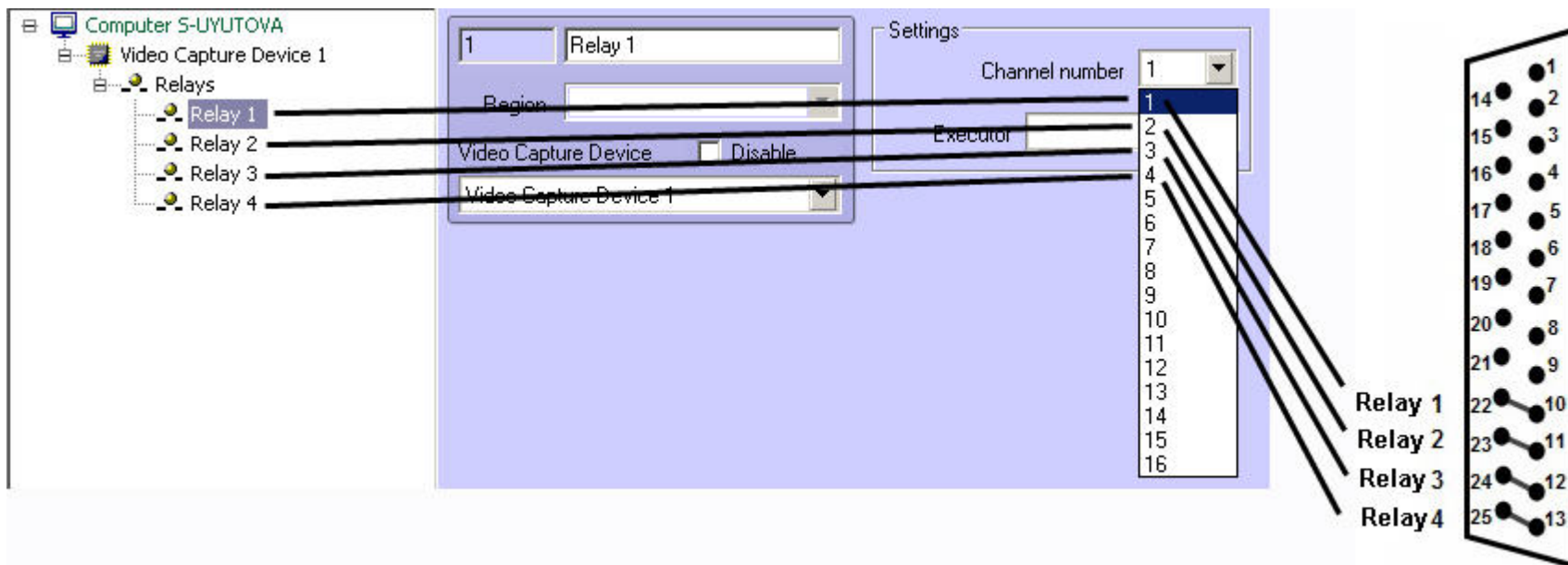

Channels of the second 4/4 Sensor-Relay card (low profile) are numbered 1-4.

Connecting sensors of 4/4 Sensor-Relay expansion cards (low profile)

Depending on what video capture card is in use, the **Sensor** objects corresponding to sensors connected to 4/4 Sensor-Relay card (low profile) are created under the **Video Capture Device** objects of one of the following types: **SC200Q4 Low profile (FS 115)**, **SC300Q16 (FX 4)**, **SC300D16 (FX 8)**, **SC310N16 (FX 16)**, **SC3B0N16 (WS 216)**, **SC230N4** and **SC590N4**.

At least one **Camera** object is to be created under the same **Video Capture device** object for sensor to work.

The **Sensor** objects are to be created under the **Video Capture Device** object that has the first PCI channel. E.g., building security video subsystem with the use of two SC300Q16 (FX4) and two Sensor-Relay cards (low profile) the **Sensor** objects are to be created under the **Video Capture Device** objects with 00 (for the first SC300Q16 (FX4) card) and 04 (for the second SC300Q16 (FX4) card) values of PCI channels.

If the Sensor-Relay card (low profile) is installed on SC3B0N16 (WS216) video capture card, then the **Sensor** objects are to be created under the **Video Capture Device** object with 00 value of the PCI-channel.

For SC310N16 (FX16) video capture card the **Sensor** objects can be created under the **Video Capture Device** object with 00 or 08 value of PCI channel. Working channel is discovered experimentally.

For SC230N4 video capture card the **Sensor** objects are to be created under the **Video Capture Device** object with 03 value of the PCI channel.

For the SC590N4 card the **Sensor** objects can be created under the **Video Capture Device** with number of PCI-channel that equals 00 (see [Connecting 4/4 Sensor-Relay \(low profile\) cards](#) section for Sensor-Relay card connected to low contacts of J2 connector of CS590N4 card) and 02 (for *DI/DO* card connected to top contacts of J2 connector of SC590N4 card). If the SC590N4 card is in use, do not create more than 4 **Sensors** objects for one **Video Capture Device**.

Note Number of PCI channels (number of the **Video Capture Device** objects) for all types of cards is given in Features of video subsystem configuration section.



One can create up to 4 **Sensor** objects under the **Video Capture Device** object. When configuring the **Sensor** objects one is to specify the channel numbers of sensor connection to 4/4 Sensor-Relay card (low profile). 4/4 Sensor-Relay card (low profile) allows connecting up to 4 sensor channels according to the license key file.

To change the channel numeration, use the **Channel Number** list on the settings panel of the **Sensor** object.

Channels are numbered according to external pinout of the card. The figure below shows an example of the channel numeration configuration of 4 sensors connected to one

4/4 Sensor-Relay card (low profile).

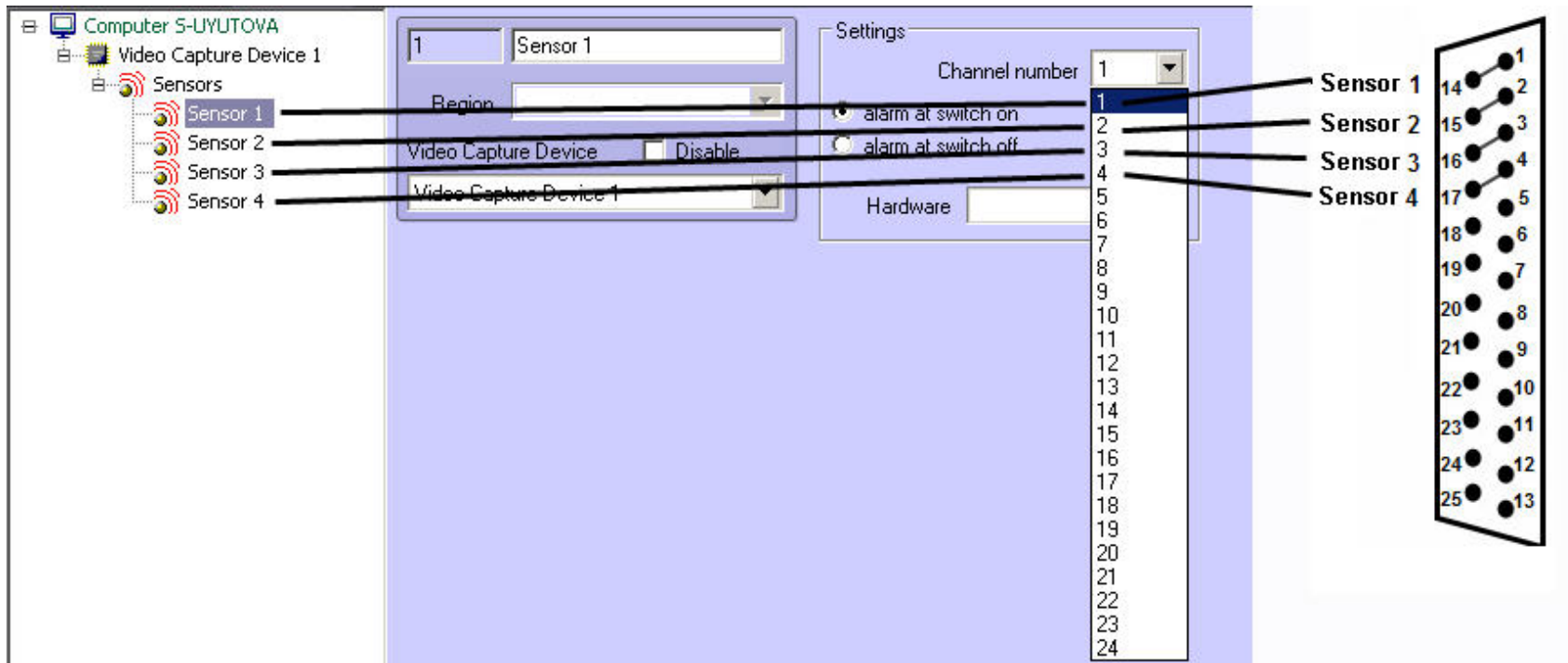

Channels of the second 4/4 Sensor-Relay card (low profile) are numbered 1-4.

Configuring SL USBIO cards

On the page:

- [Connecting relays](#)
- [Connecting sensors](#)

Connecting relays

The **Relay** objects corresponding to relays connected to SL USBIO (4x4, 16x8 and 24x4) card are created under the **Video Capture Device** objects of the **SL USBio** type.

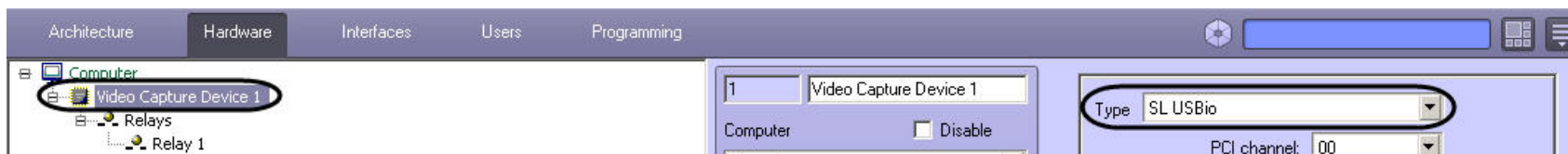

When configuring the **Relay** objects one is to specify the channel numbers of relay connection to the card. Channels are numbered according to external pinout of the card (see Appendix 6. Electrical and technical specifications of Sensor-Relay cards).

To change the channel numeration, use the **Channel Number** list on the settings panel of the **Relay** object.

Connecting sensors

The **Sensor** objects corresponding to sensors connected to SL USBIO (4x4, 16x8 and 24x4) card are created under the **Video Capture Device** objects of the **SL USBio** type.



When configuring the **Sensor** objects one is to specify the channel numbers of sensor connection to the card. Channels are numbered according to external pinout of the card (see Appendix 6. Electrical and technical specifications of Sensor-Relay cards).

To change the channel numeration, use the **Channel Number** list on the settings panel of the **Sensor** object.

Configuring MO USBIO 4x4 devices

Connecting relays MO USBIO 4x4

The **Relay** objects corresponding to relays connected to MO USBIO 4x4 device are created under the **Video Capture Device** objects of the **MO USBio** type. One can create up to 4 **Relay** objects under the **Video Capture Device** object.

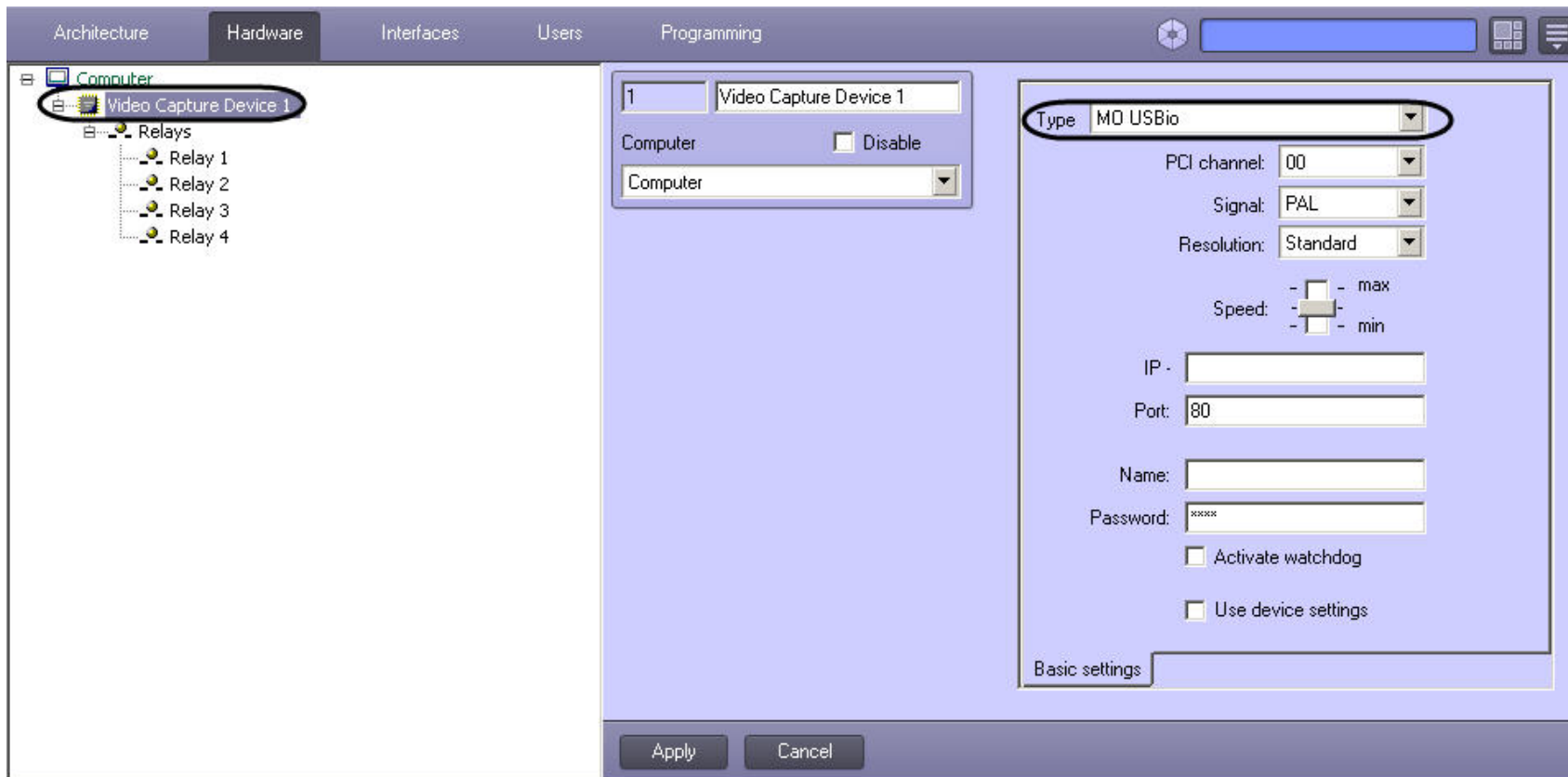

Note
One is to specify the number of PCI channel that is not used by another object.

When configuring the **Relay** objects one is to specify the channel numbers of relay connection to MO USBIO 4x4 device. Channels are numbered according to external pinout of the device (see [Connecting MO USBIO 4x4 external module](#) or [Connecting MO USBIO 4x4 cards](#) sections).

To change the channel numeration, use the **Channel Number** list on the settings panel of the **Relay** object.

MO USBIO 4x4 device allows connecting up to 4 relay channels according to the license key file.

The figure below shows an example of the channel numeration configuration of 4 relays connected to one MO USBIO 4x4 device.

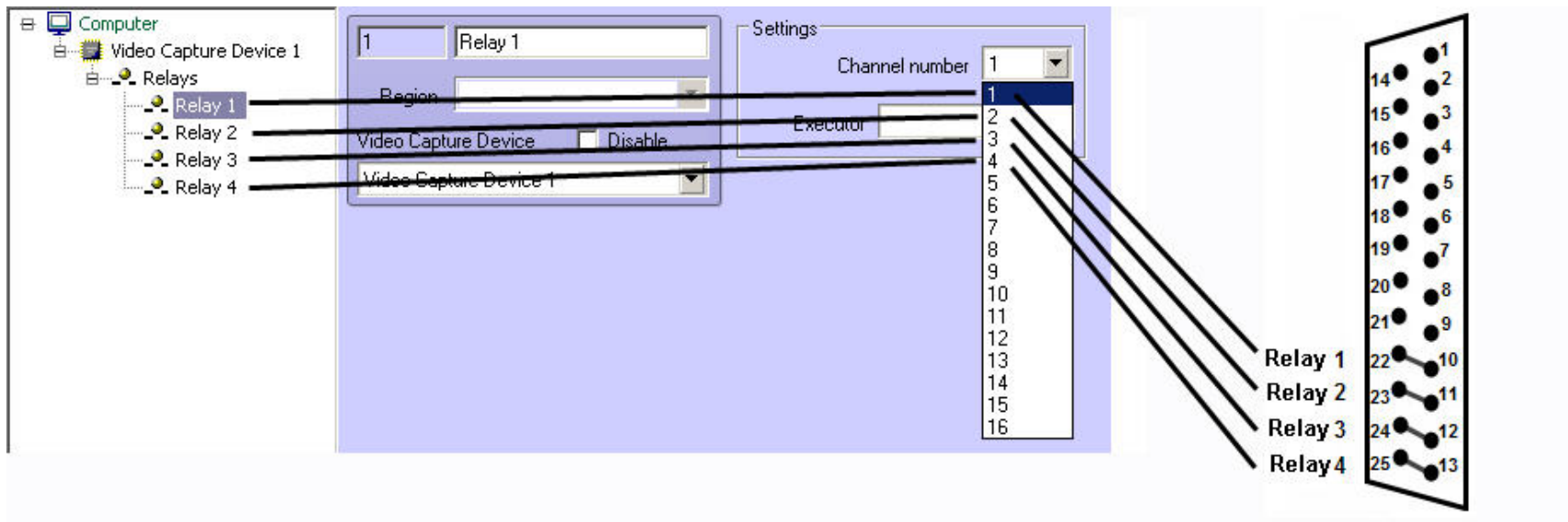

The channels of the second (next) device are numbered 1-4.

Connecting sensors MO USBIO 4x4

The **Sensor** objects corresponding to sensors connected to MO USBIO 4x4 device are created under the **Video Capture Device** objects of the **MO USBio** type. One can create up to 4 **Sensor** objects under the **Video Capture Device** object.

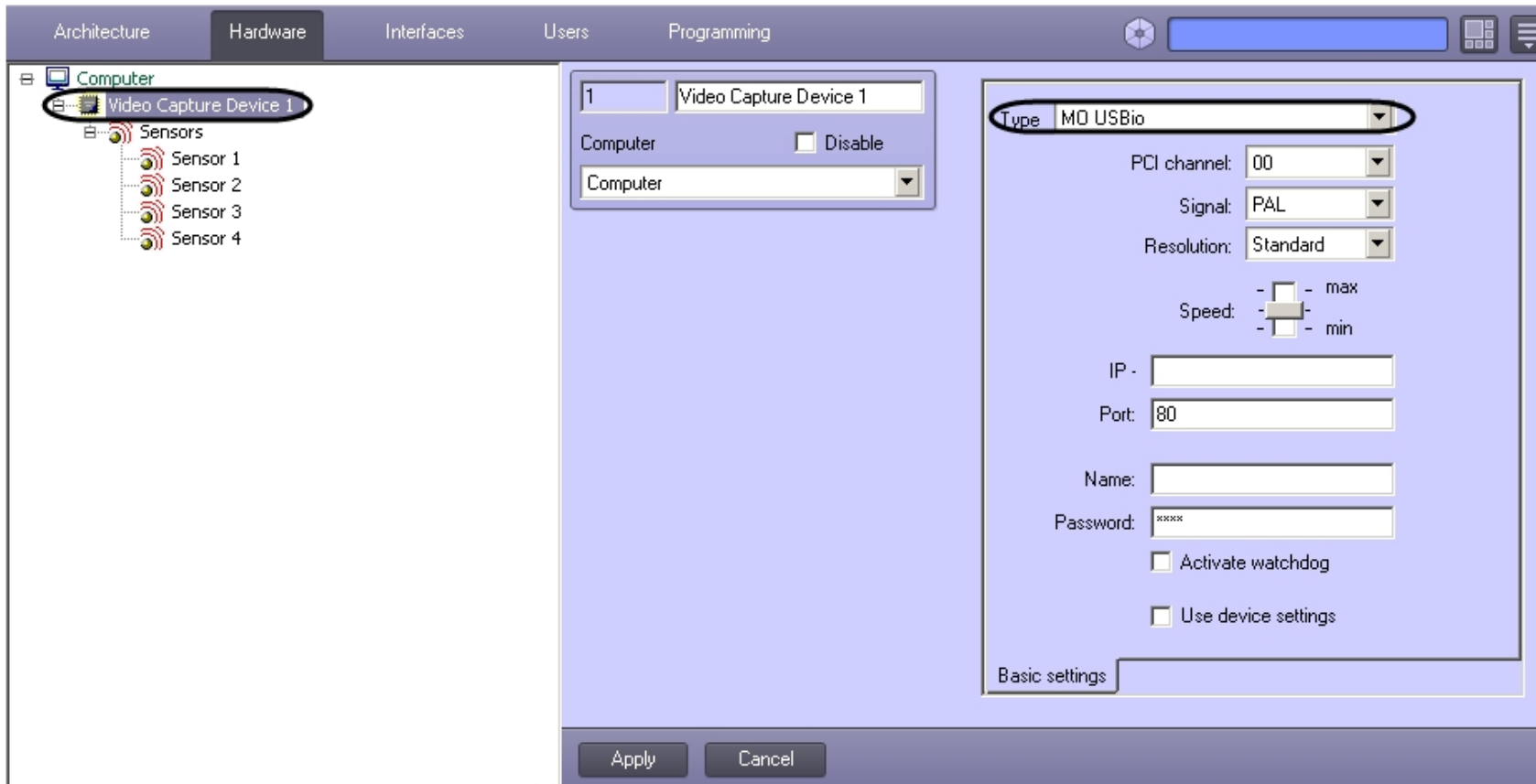

Note
One is to specify the number of PCI channel that is not used by another object.

When configuring the **Sensor** objects one is to specify the channel numbers of sensor connection to MO USBIO 4x4 device. Channels are numbered according to external pinout of the device (see [Connecting MO USBIO 4x4 external module](#) or [Connecting MO USBIO 4x4 cards](#) sections).

To change the channel numeration, use the **Channel Number** list on the settings panel of the **Sensor** object.

MO USBIO 4x4 device allows connecting up to 4 sensor channels according to the license key file.

The figure below shows an example of the channel numeration configuration of 4 sensors connected to one MO USBIO 4x4 device.

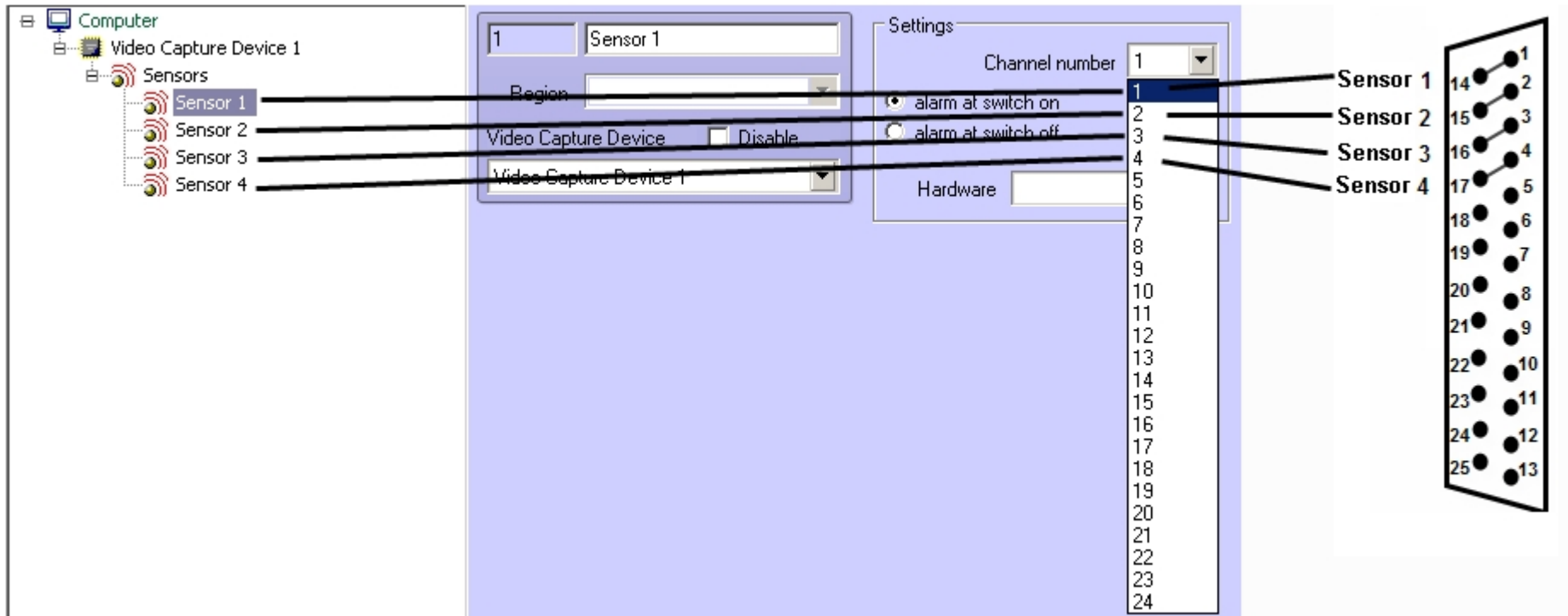

The channels of the second (next) device are numbered 1-4.

Configuring Sensor-Relay (Stretch) cards

On the page:

- [Connecting relays](#)
- [Connecting sensors](#)

Connecting relays

One can connect up to 8 executive devices (relays) to one Sensor-Relay (Stretch) card.

The **Relay** objects corresponding to relays connected to Sensor-Relay (Stretch) card are created under the **Video Capture Device** objects of the **Stretch** type.

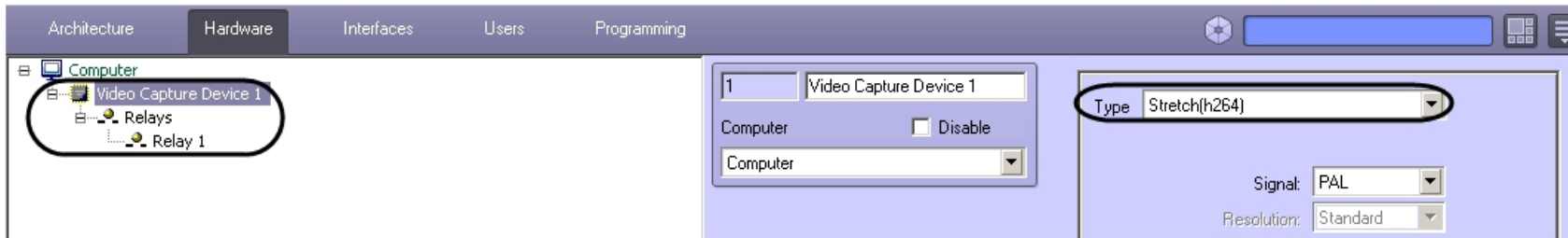

When configuring the **Relay** objects one is to specify the channel numbers of relay connection to the card. Channels are numbered according to external pinout of the card (see [Connecting Sensor-Relay \(Stretch\) cards](#) section).

To change the channel numeration, use the **Channel Number** list on the settings panel of the **Relay** object.

Connecting sensors

One can connect up to 8 sensors to one Sensor-Relay (Stretch) card.

The **Sensor** objects corresponding to sensors connected to Sensor-Relay (Stretch) card are created under the **Video Capture Device** objects of the **Stretch** type.

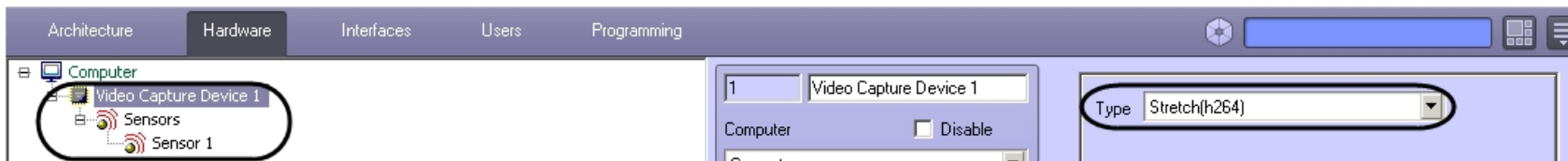

When configuring the **Sensor** objects one is to specify the channel numbers of sensor connection to the card. Channels are numbered according to external pinout of the card (see [Connecting Sensor-Relay \(Stretch\) cards](#) section).

To change the channel numeration, use the **Channel Number** list on the settings panel of the **Sensor** object.

Configuring sensors and relays connected via IP devices

If relays are connected to the Server via IP devices, then select the corresponding type of IP device on the settings panel of the **Video Capture Device** object; set IP address, name and password in order to connect to camera (see [Configuring IP devices](#) section).

Note
If relays are connected to the Server via Bosh IP device, then specify the **service** value in the **Name** field. With another value the functionality of the relay is not performed on the Server.

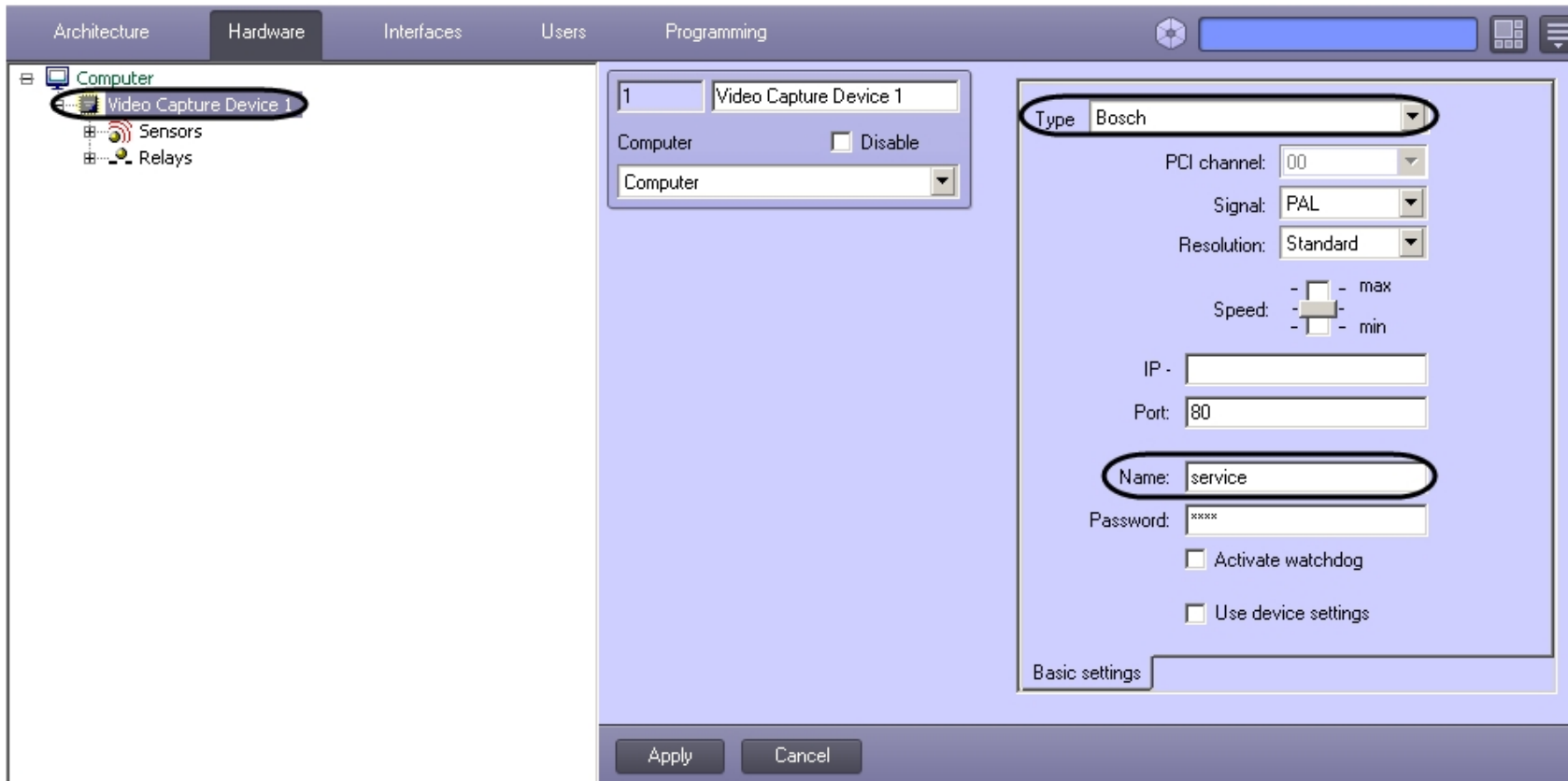

If Smartec STS-IPT-880 IP server is in use, then sensors are to be connected to those channels for which the **Camera** objects are created. Channel with N number corresponds to 2 sensor channels with 2N-1 and 2N numbers.

Note
Smartec STS-IPT-880 IP Server supports up to 8 video channels and 16 sensors (2 sensors for each channel).

To connect each pair of sensors create the **Camera** object with **N** channel number, then create two **Sensor** objects with 2N-1 and 2N channel numbers. The **Camera** and **Sensor** objects are created under one **Video Capture Device** object of the **Smartec** type. If sensors are connected via inactive video channel (no **Camera** object), then the functionality of sensors is not performed on the Server.

To implement the functionality of sensors connected via AEBELL BL-E704F IP server disable the **Auto Work Plan** mode. This mode is enabled/disabled via Web interface of IP server or in the dialog box of the **Network DVR Monitor System** utility (see the reference documentation on IP server).

Telemetry configuration

Use of PTZ devices in the digital video surveillance system

PTZ devices in the digital video surveillance system are used to widen the video surveillance zone by mechanical rotating of the video camera.

The following interface elements of the *INTELLECT™* software control the PTZ devices:

1. Surveillance monitor;
2. Telemetry control;
3. Telemetry control panel.

PTZ device is controlled with the help of the following:

1. Mouse and standard keyboard (when using **Surveillance monitor** and **Telemetry control panel** interface objects).
2. Custom devices used for telemetry control, like telemetry remote control and joystick.

To manage simultaneous use of PTZ devices by different users, priorities of PTZ devices control must be set up for the following interface objects:

1. Surveillance monitor;
2. Telemetry control;
3. Telemetry control panel.

Priorities of PTZ control

The **PTZ control** or **Priority** parameter (depending on the type of the object) gives the privileges to control PTZ devices when several interface objects are used or several users control the same PTZ device simultaneously.

To configure interface objects used for PTZ control the value of PTZ control priority is to be selected in the list.

The **PTZ control** parameter is set for the following objects:

1. Surveillance monitor;
2. Telemetry control;
3. Telemetry control panel.



Note

The priority of PTZ control with joystick equals the priority of PTZ control with **Surveillance monitor** and mouse.

Priority parameter of PTZ control can be:

1. Control is forbidden (Forbidden). This item forbids PTZ control.
2. Low (Low priority). PTZ control is the last in the queue after the "normal" and "high" priorities. It is the lowest in the queue in PTZ control.
3. Normal (Normal priority). PTZ is controlled after the device with "high" priority. It is higher in the queue in PTZ control than any device with "low" priority.
4. High (High priority). This item is set as first in the queue in PTZ control. It is the highest in the PTZ control queue.

Contextual menu of selecting the PTZ control priority for the **Monitor** interface object is called **PTZ control** and consists of **Forbidden**, **Low priority**, **Normal priority** and **High priority** items:

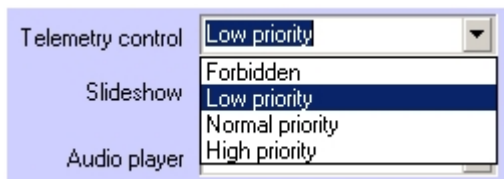

The panel for selecting the PTZ control priority for the **Telemetry control panel** interface object and **Telemetry remote control** system object is called **Priority** and consists of **Forbidden**, **Low priority**, **Normal priority** and **High priority** items:

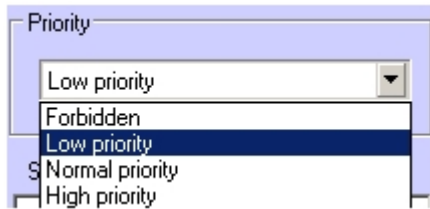

If the same PTZ device is controlled from several workstations with the interface objects of the same type with the same PTZ control priority, then the following rules apply:

1. Any user can control a PTZ device when it is not controlled by another user with the interface of the same control priority.
2. If a user who controls interface object with a higher priority delegates control to a user who controls interface object with a lower priority, then this procedure is delayed. The priority delay time is set with the help of the tweaki.exe utility (Intellect Advanced Setup).

To change the priority delay time using the tweaki.exe utility, do the following:

1. Run the tweaki.exe utility in the **Tools** folder of the INTELLECT™ software installation directory.
2. Select the **PTZ** section (**1**).

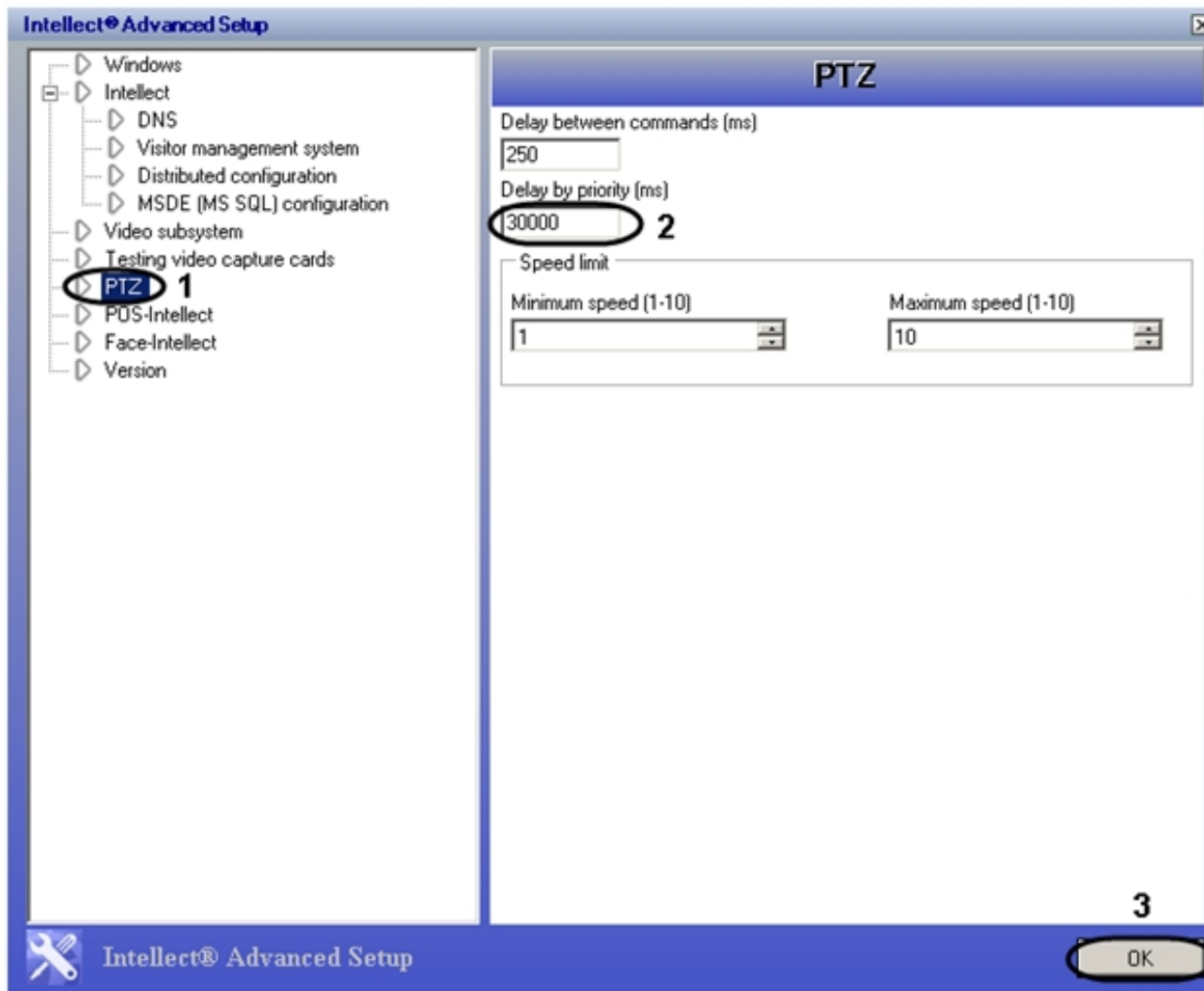

3. Specify the value of PTZ control priority delay in the **Delay by priority (ms)** field (2). The delay parameter is given in milliseconds. The default value is 30000.
4. Click the **OK** button to save the changes (3).

Note When the objects are configured with variable PTZ priority controls it is recommended to assign different PTZ control priorities to different system objects (object types). If different system objects have the same PTZ control priority, problems may occur in operation, especially in controlling the PTZ devices.

Configuring PTZ devices (telemetry)

PTZ device setting procedure

PTZ device configuration in the *INTELLECT™* software consists of creation and configuration of system objects corresponding to the PTZ module, and user interface for PTZ device operation.

The user interface for PTZ device operation is represented by the following interface objects:

1. **Telemetry control panel**;
2. **Operator query panel**;
3. **Video Monitor**.

Here is PTZ device setting procedure:

1. Configure Server ports to connect PTZ devices (see [Configuring Server ports and remote workstation to connect PTZ devices](#)).
2. Configure PTZ devices (see [Configuring PTZ devices in INTELLECT™](#)).
3. Configure **Control panel** (see [Configuring Control panel](#)).
4. Configure **Telemetry control panel** (see [Telemetry control panel configuration](#)).
5. Configure **Operator query panel** for telemetry control (PTZ devices of certain type) (see [Creating and configuring the Operator query panel for telemetry control](#)).
6. Configure **Video Monitor** to control PTZ device with the help of mouse or joystick (see [Configuring the Monitor for telemetry control](#)).
7. Configure the joystick for PTZ control (see [Configuring the joystick for telemetry control](#)).
8. Configure the mouse buttons to control PTZ device (see [Configuring the mouse buttons to control PTZ devices](#)).

Configuring Server ports and remote workstation to connect PTZ devices

PTZ devices are connected to the Server serial ports (COM). *INTELLECT™* allows connecting the required number of PTZ devices on demand.

Data exchange with a PTZ device is performed via the serial port (COM) in accordance with a specialized protocol. Each type of PTZ devices has its own exchange protocol. Only one exchange protocol can be selected for data exchange via the serial port (COM). Therefore only one type of PTZ devices can be connected to one serial port (COM).

Several serial ports (COM) are configured one after another. Each type of serial ports (COM), used to connect the PTZ device, has the corresponding **Telemetry Controller** object created and configured in the **Hardware** tab of the **System settings** dialog box.

To configure the serial port (COM) used for connecting PTZ devices of the same type, do the following:

1. Go to the **Hardware** tab in the **System settings** dialog box (1).
2. Create the **Telemetry Controller** system object under the **Computer** object or select the corresponding object in the object tree in the **Hardware** tab of the **System settings** dialog box (2).

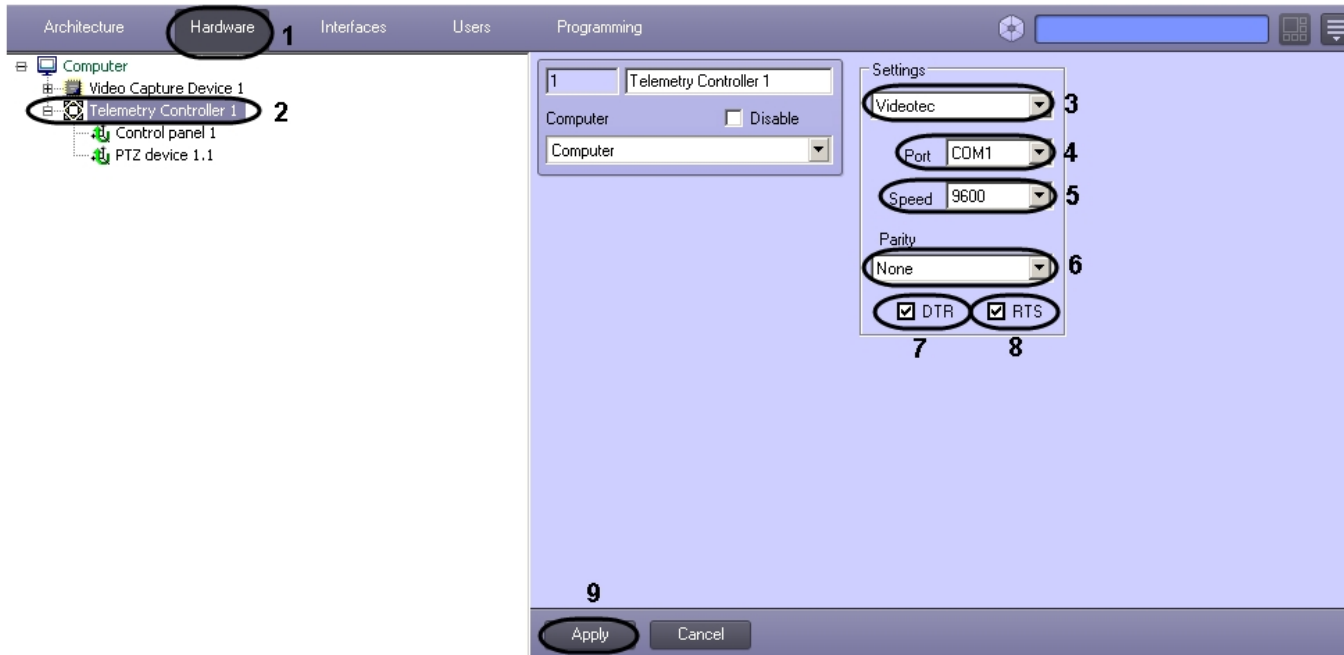

3. When the **Telemetry Controller** object is created, enter the ID, the name of the object and select the Server to the COM port of which the PTZ device is connected.
4. Select the protocol of data exchange with PTZ device in the list. The names of data exchange protocol in this list correspond to the names of PTZ types (3).
5. Select the serial port (COM) number in the **Port** list (4).

Important!
 The port is to be selected only if the PTZ device is connected to the computer COM port. Otherwise, if PTZ control is to be performed on the IP device, select an empty value. PTZ control commands will be sent via the device driver and the RS-485 or RS-232 network address will be set on the settings panel of the **PTZ device** object (see [Configuring PTZ devices in INTELLECT™](#)).

Note.
 If OKO telemetry system is in use, select the NM port number in the **Port** drop-down list (4).

6. Change the data exchange speed if necessary (5).

Note
 Take into account that the data exchange speed via the COM port is specified by the vendor of PTZ device. The speed of data exchange with the PTZ device via the COM port must be the same as speed specified by the vendor.

Note
 If you need to change the COM port settings, change the relevant COM port settings in the Windows OS (information on how to configure COM port in the Windows OS can be found in [Appendix 4. Technical specifications of video capture cards](#)).

7. Change the parity check parameters for the data exchange if necessary (6).
8. If PTZ devices are passive (i.e. with no power supply), the power supply of the PTZ devices must be activated via the DTR or RTS outputs of the COM port by setting the **DTR** or **RTS** checkboxes checked (7,8).
9. To save the changes click the **Apply** button (9).

Configuring PTZ devices in INTELLECT™

The number of PTZ devices connected to the Server is specified in the license key bundled with *INTELLECT™* distribution kit.

Every PTZ device has the corresponding **PTZ device** system object in *INTELLECT™*. The **PTZ device** object is a child object to the **Telemetry Controller** object.

PTZ device configuration involves selection of the camera equipped with a PTZ device and setting PTZ MAC addresses.

Several PTZ devices are configured one after another.

To configure PTZ devices do the following:

1. Go to the **Hardware** tab in the setting panel of *INTELLECT™* (1).
2. Create a **PTZ device** object under the **Telemetry controller** object or select the relevant object in the object tree in the **Hardware** tab of the **System settings** dialog box (2).

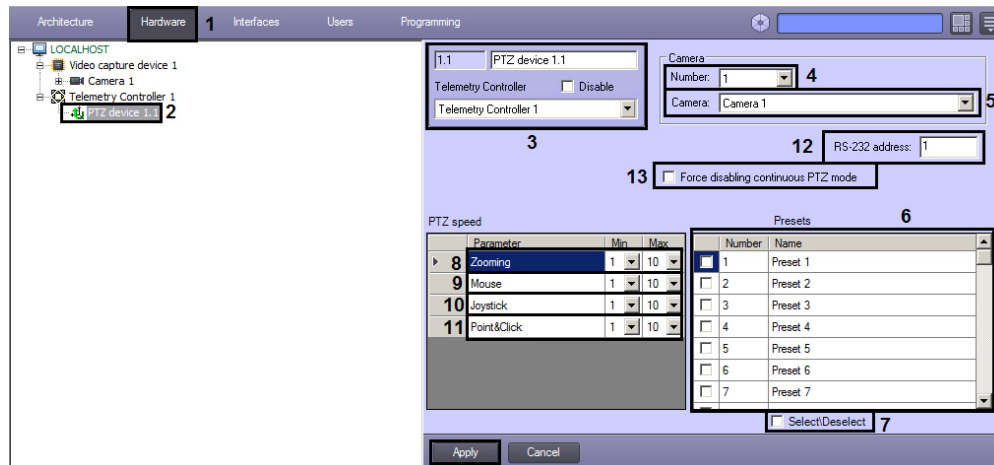

3. Specify the ID, the name of the **PTZ device** object and select the **Telemetry controller** object to which the PTZ device is connected (3).
4. Select the ID of the camera equipped with a PTZ device (4).
5. Select the name of the camera equipped with a PTZ device (5).

Note
Specify either the video camera ID or its name.

6. In the **Presets** table set checkboxes checked next to the names of presets that are to be displayed on **Telemetry control panel** (see [Telemetry control panel configuration section](#)). Change the preset's name if necessary (6).

Note
In order to select all presets or cancel this operation, use the **Select/Deselect** checkbox (7).

7. Set minimal and maximal speed of optical zoom in standard units for PTZ device in the **Zooming speed** group (8).

8. Set minimal and maximal rotation speed in standard units for PTZ device while mouse control from the Monitor in the **Mouse** group (9).
9. Set minimal and maximal rotation speed while joystick control in the **Joystick** group (10)
10. Set minimal and maximal rotation speed of PTZ device in direction of mouse click (Point&Click) in standard units for PTZ device in the **Point&Click** group (11).
11. Specify the MAC address of the PTZ device in the **RS-232 address** field. The PTZ MAC address corresponds to the address set on the PTZ device with the help of jumpers or configured while programming the PTZ device in the the bundled software (12).
12. If the continuous PTZ mode (Continuous Mode) is to be disabled, set the **Force disabling continuous PTZ mode** checkbox checked (13).



Note.

If the checkbox is set unchecked, then the continuous PTZ mode is automatically enabled for the PTZ devices that support it.

13. To save the changes click the **Apply** button (14).

Configuring Control panel

A telemetry control panel is used to control PTZ devices. The **Control panel** system object is used for the telemetry control panel hardware device registration in INTELLECT™.

To register and configure the **Control panel** object, do the following:

1. Go to the **Hardware** tab in the **System settings** dialog box (1).
2. Create the **Control panel** system object under the **Telemetry Controller** object or select the relevant object in the **Hardware** tab of the **System settings** dialog box (2).



Attention!

If control panel is connected using the USB interface, then all settings related to COM-port are ignored by system. In this case go to step 8.

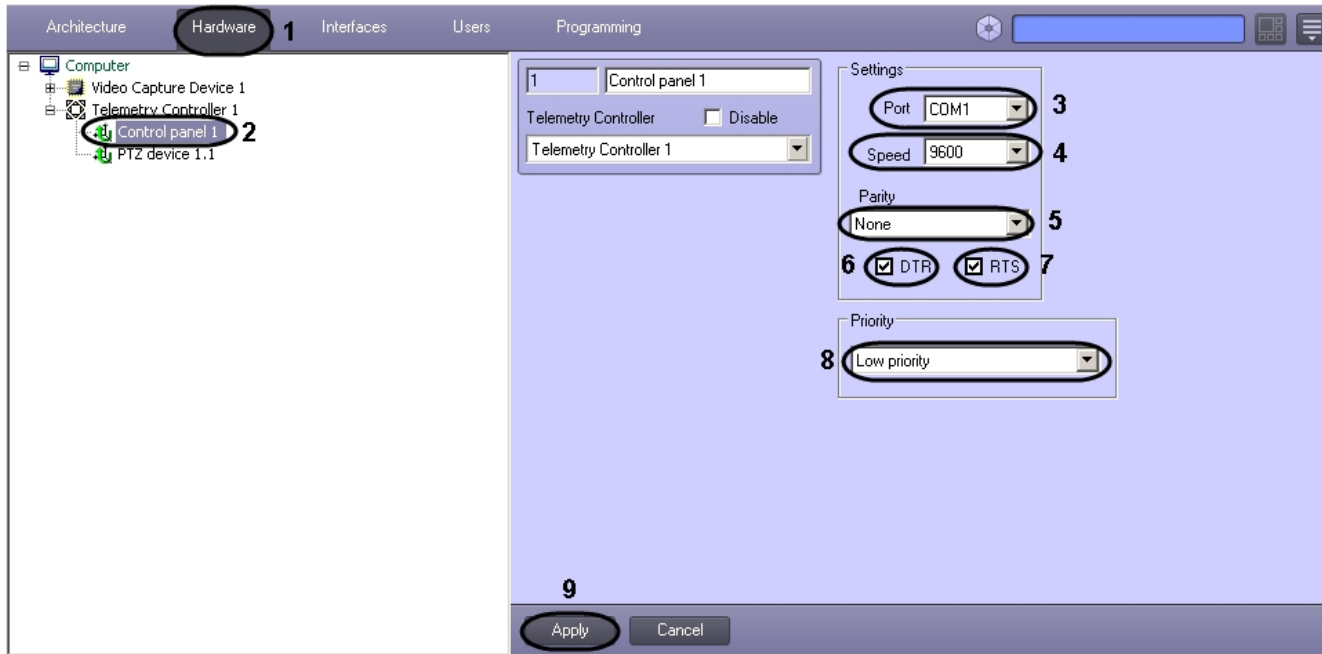

3. Specify the ID, the name of the **Control panel** object and select the **Telemetry controller** object to which the PTZ device is connected.
4. Select the COM port number in the **Port** list in order to connect the **Control panel** device (3).

Note
The Control panel is connected to the COM port different from that to which the PTZ device is connected. Therefore another COM port number must be specified on the settings panel of the parent (for the **Control panel** object) **Telemetry Controller** object.

5. Specify the speed of data exchange between the computer and the telemetry control panel device if necessary (4).
6. Specify parity check parameters for the data exchange if necessary (5).
7. If the telemetry control panel device is passive (i.e. with no independent power supply), the power supply is to be activated via the DTR or RTS outputs of the COM port by setting the **DTR** or **RTS** check boxes (6,7).

Note
The COM port speed and parity settings of the parent Telemetry controller object do not relate to the similar settings of the **Control panel** object as they refer to another COM port.

Note
The **Speed** and **Parity** settings must be the same as the COM port settings in the Windows OS.

8. Change the PTZ device control priority for the telemetry control panel device, select the relevant item in the **Priority** list (8).
9. To save the changes click the **Apply** button (9).

Features of BOSCH KBD-Digital or BOSCH KBD-Universal control panel configuration and operation

On the page:

- [Configuring BOSCH KBD-Digital or BOSCH KBD-Universal control panel in INTELLECT™](#)
- [Features of BOSCH KBD-Digital or BOSCH KBD-Universal control panel operation in INTELLECT™](#)
- [Example of JScript script](#)

Configuring BOSCH KBD-Digital or BOSCH KBD-Universal control panel in INTELLECT™

Configure BOSCH KBD-Digital or BOSCH KBD-Universal control panel in *INTELLECT™* as follows:

1. Create the **Telemetry Controller** object.
2. Configure the **Telemetry Controller** object as follows:

The screenshot shows a configuration window for a Telemetry Controller. On the left, there is a tab labeled '1' and a text field containing 'Telemetry Controller 1'. Below this, there is a 'Computer' label with a 'Disable' checkbox and a dropdown menu currently showing 'Computer'. On the right, a 'Settings' panel contains several configuration options: a dropdown menu for 'Bosch-IntuiKey', a 'Port' dropdown menu set to 'COM1', a 'Speed' dropdown menu set to '19200', a 'Parity' dropdown menu set to 'None', and two checked checkboxes for 'DTR' and 'RTS'. At the bottom of the window, there are 'Apply' and 'Cancel' buttons.

- a. Set the **Bosch-IntuiKey** interface protocol.
- b. Select the COM port in the **Port** list.

- c. Set **19200** value to the **Speed** parameter.
 - d. Set the **None** value for the **Parity** parameter.
 - e. Set the **DTR** and **RTS** checkboxes checked.
3. Create the **Control panel** system object under the **Telemetry Controller** object.
 4. Configure the **Control panel** object as described in [Configuring Control panel](#) section.

BOSCH KBD-Digital or BOSCH KBD-Universal control panel is now configured in *INTELLECT™*.

Features of BOSCH KBD-Digital or BOSCH KBD-Universal control panel operation in INTELLECT™

 **Attention!**
Before you start using BOSCH KBD-Digital or BOSCH KBD-Universal control panel in *INTELLECT™*, switch it to the **Terminal mode**. For this press the **Prod** key and select **Terminal** on the monitor.

 **Note**
Detailed information on BOSCH KBD-Digital or BOSCH KBD-Universal control panel is given in official reference documentation on this device.

When the key is pressed on BOSCH KBD-Digital or BOSCH KBD-Universal control panel there is **Key is pressed** or **Key is released** message in *INTELLECT™*.

Event	Message	Parameter	Description
KEY_PRESSED	Key pressed	param0	Code of pressed key
KEY_RELEASED	Key released	param0	Code of released key

In the comments to these events the code (param0) of pressed and released key is specified.

 **Note**
With long key pressing (more than 500 milliseconds) the **Key is pressed** event is repeated with 100 milliseconds interval. Releasing the key one **Key is released** message is received.

Key codes of BOSCH KBD-Digital or BOSCH KBD-Universal control panel:

Key	Key code	Key	Key code
SOFTKEY 1L	0x01	4	0x34
SOFTKEY 2L	0x02	5	0x35
SOFTKEY 3L	0x03	6	0x36
SOFTKEY 4L	0x04	7	0x37
SOFTKEY 5L	0x05	8	0x38
SOFTKEY 6L	0x06	9	0x39
SOFTKEY 7L	0x07	MONITOR	0x20
SOFTKEY 1R	0x08	PRODUCT	0x21

SOFTKEY 2R	0x09	CLEAR	0x22
SOFTKEY 3R	0x0A	IRISA	0x23
SOFTKEY 4R	0x0B	IRISB	0x24
SOFTKEY 5R	0x0C	ACK	0x25
SOFTKEY 6R	0x0D	ENTER	0x26
SOFTKEY 7R	0x0E	SHOT	0x27
0	0x30	FOCUSA	0x28
1	0x31	FOCUSB	0x29
2	0x32	0 + 1	0x81
3	0x33	MONITOR + CLEAR	0x82

The following special features are available for *BOSCH KBD-Digital* or *BOSCH KBD-Universal* control panel:

1. **Paint figure** (set by **Figure**, **Type of painting**, **Paint figure**, **original Y-coordinate**, **end Y-coordinate**, **original X-coordinate**, **end X-coordinate** and **Screen**).
2. **Clear screen** (set by **Screen** parameter).
3. **Type text** (set by **X-coordinate**, **Y-coordinate**, **Coding**, **Style**, **Screen** and **Text** parameters).



Note

Bold text is displayed only on the status display.

Example of JScript script

[bosch.txt](#) and [bosch_menu.txt](#) files are available when clicking the links.

[bosch_menu.txt](#) file consists of Jscript script that, when initiated by macro, displays the menu on the *BOSCH KBD-Digital* or *BOSCH KBD-Universal* telemetry control panel. This menu shows the correspondence of *keys of BOSCH KBD-Digital* or *BOSCH KBD-Universal* control panels to the actions they perform. This script is to be run just once.

[bosch.txt](#) file consists of Jscript script that assigns actions to *keys of BOSCH KBD-Digital* or *BOSCH KBD-Universal* control panels as follows:

Key	Code (denary)	Code (hexadecimal)	Action
SOFTKEY 1L	1	0x01	Display 1 wideo surveillance window on the monitor
SOFTKEY 2L	2	0x02	Display 4 wideo surveillance windows on the monitor
SOFTKEY 3L	3	0x03	Display 9 wideo surveillance windows on the monitor
SOFTKEY 4L	4	0x04	Display all wideo surveillance windows
SOFTKEY 5L	5	0x05	Rewind
SOFTKEY 6L	6	0x06	Playback
SOFTKEY 7L	7	0x07	Go to the archive playback mode
SOFTKEY 1R	8	0x08	Export frame

SOFTKEY 2R	9	0x09	Print frame
SOFTKEY 3R	10	0x0A	Run macro 2
SOFTKEY 4R	11	0x0B	Run macro 3
SOFTKEY 5R	12	0x0C	Forward wind
SOFTKEY 6R	13	0x0D	Stop playback
SOFTKEY 7R	14	0x0E	Go to the video surveillance mode
MONITOR	32	0x20	Specify monitor ID
ACK	37	0x25	Display menu (run macro 1)
ENTER	38	0x26	Specify camera ID
SHOT	39	0x27	Go to preset

Example of how to use script.

Task: to display camera 2 on the monitor 1 and go to preset 3.



Note.

Preset 3 is to be saved, for example using the [PTZ control with Universal PTZ control panel](#).

1. Click the 1 button, then click the MONITOR button. The information about current monitor number is displayed on the display of the control panel.
2. Click the 2 button on the control panel, then click the ENTER button. As a result camera 2 is displayed on the monitor 1, and information about current camera number is displayed on the display of the control panel.
3. Click the 3 button on the control panel, then click the STOP button. As a result camera 2 switches to preset 3, and information about current preset number is displayed on the display of the control panel.

Features of Axis T8310 control panel configuration and operation

On the page:

- [Configuring Axis T8310 control panel in INTELLECT™](#)
- [Features of Axis T8310 control panel operation in INTELLECT™](#)
- [Example of script in JScript](#)

Configuring Axis T8310 control panel in INTELLECT™

Configure Axis T8310 control panel in *INTELLECT™* as follows:

1. Create the **Telemetry controller** object.
2. Configure the **Telemetry controller** object as follows:

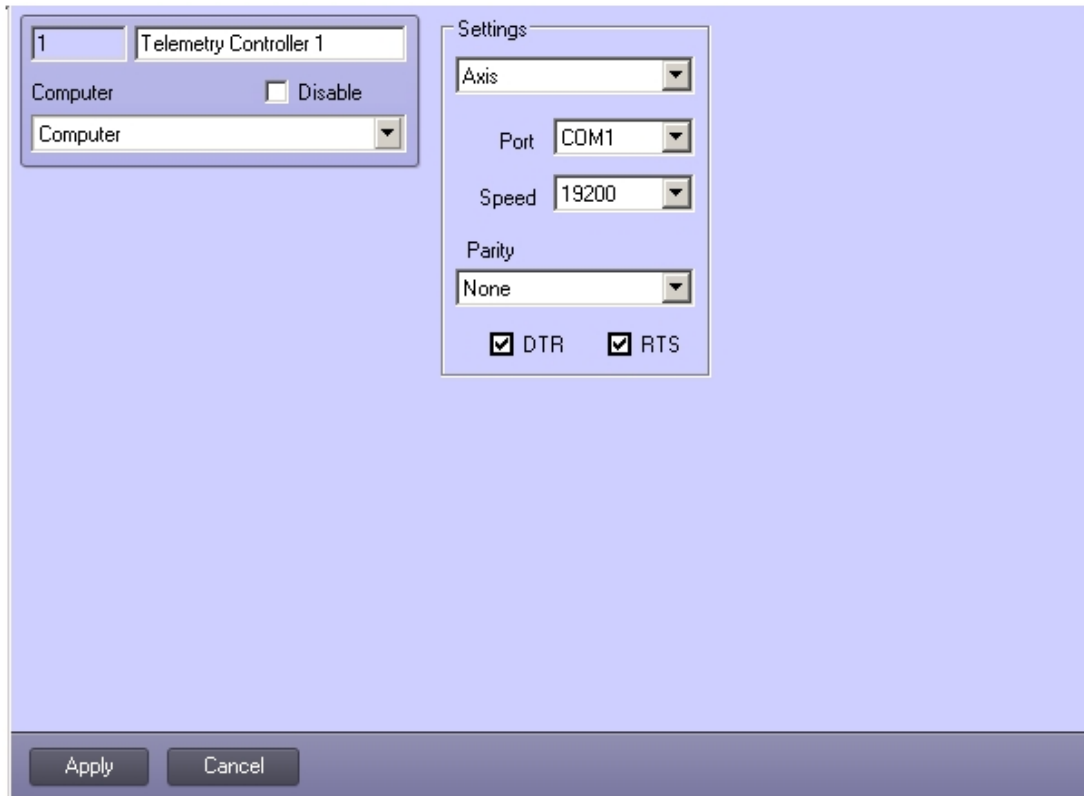

- a. Set the **Axis** interface protocol.
- b. Other settings of this object are ignored by system because the control panel of *Axis T8310* telemetry is connected to the Server using USB interface.
3. Create the **Control panel** system object under the **Telemetry controller** object.
4. Configure the **Control panel** object as described in [Configuring Control panel](#) section.

Axis T8310 control panel is now configured in INTELLECT™.

Features of Axis T8310 control panel operation in INTELLECT™



Note

Detailed information on Axis T8310 control panel is given in official reference documentation on this device

Pressing the key on Axis T8310 control panel there is **Key is pressed** or **Key is released** message in *INTELLECT™*.

AXIS T8310 control panel is a modular system that consists of three devices:

1. AXIS T8311 joystick. This device has functionality of an ordinary joystick and it is configured in the standard way (see [Configuring the joystick for telemetry control](#) section). The device also has 6 hot keys.

**Note.**

By default the image zooms out if z axis is rotated right (in clockwise order) and zooms in if z axis is rotated left (counterclockwise) while the telemetry is controlled in the Monitor using Axis 8311 joystick.

2. AXIS T8312 keyboard has 10 hot keys and 12 programmed keys.
3. AXIS T8313 Jog Dial has 6 hot keys and a navigation wheel.

If complete AXIS T8310 control panel is used, then modules are connected to each other via AXIS T8312 keyboard (USB hub).

Functions of control panel related to pressing keys can be performed with the help of following:

1. scripts in JScript (see details on how to create scripts in [Programming Guide \(JScript\)](#));
2. programs in internal language in INTELLECT;
3. macros (see details in [Administrator's Guide, Creating and using macros](#) section).







Pressing the key on the keyboard of AXIS T8310 control panel in *INTELLECT™* there is **Key is pressed** or **Key is released** message.

Description of 'Key is pressed' and 'Key is released' messages:

Event	Message	Parameter	Description	Value range
KEY_PRESSED	Key pressed	param0	Code of pressed key	0..21
		device	Device with pressed key.	0 - AXIS T8312 main keyboard, 1 - AXIS T8313 keyboard
KEY_RELEASED	Key pressed	param0	Code of released key	0..21
		device	Device with released key	0 - AXIS T8312 main keyboard, 1 - AXIS T8313 Jog Dial

The **Cotrol panel** object (TELEMETRY_EXT) is the issuer of these events. In the comment to these events the code of pressed and released key is specified.

Key codes of AXIS T8312 control panel:

Key	Key code	Key	Key code
0	0	Alt	11
1	1		12
2	2		13
3	3		14
4	4		15
5	5		16
6	6	F1	17
7	7	F2	18
8	8	F3	19
9	9	F4	20
	10	F5	21

When the position of AXIS T8313 joystick is changed then there is the **Position is changed** message.

Description of **Position is changed** message:

Event	Message	Parameter	Description	Value range
MOVED	Position changed	param0	Offset value	JogDial -1.. 1; shuttle -7..7
		device	'AXIS T8313' type of control-gear	0 – JogDial, 1 – shuttle



The following special features are available for AXIS T8310 control panel:

1. Switch on relay (set by **Relay identifier** parameter). This command allows switching on the light on the key with light (12-16).
2. Switch off relay (set by **Relay identifier** parameter). This command allows switching off the light on the key with light (12-16).



Example of script in JScript

The [link](#) provides the file containing the script on JScript, which allows assigning actions to the keys of the AXIS T8310 telemetry control panel as follows:

Axis T8312

Key	Action
F1	1-CAM layout
F2	4-CAM layout
F3	9-CAM layout
F4	16-CAM layout
F5	25-CAM layout
	Monitor ID
	Camera ID
	Go to preset
	not used
	Save preset
	Switch between live-view & archive
Alt	not used

Axis T8313

Key	Action
	standart controls
[L]	export frame
[R]	export arch
	Outer control = increase/decrease camera surveillance window size Inner control = next/previous

Usage example:

1. To activate Camera 3 on Monitor 12 do the following:

a. Press 12 then  .

b. Press 3 then  .

2. To go to preset #2 do the following:

a. Press 2 then  .

Features of Lilin PIH-800III control panel configuration and operation

On the page:

- [Configuring Lilin PIH-800III telemetry control panel](#)
- [Using Lilin PIH-800III telemetry control panel](#)

Configuring Lilin PIH-800III telemetry control panel

Configure the *Lilin PIH-800III* telemetry control panel in the *Intellect* as follows:

1. Create the **Telemetry controller** object.
 - a. Configure the **Telemetry controller** object as follows:

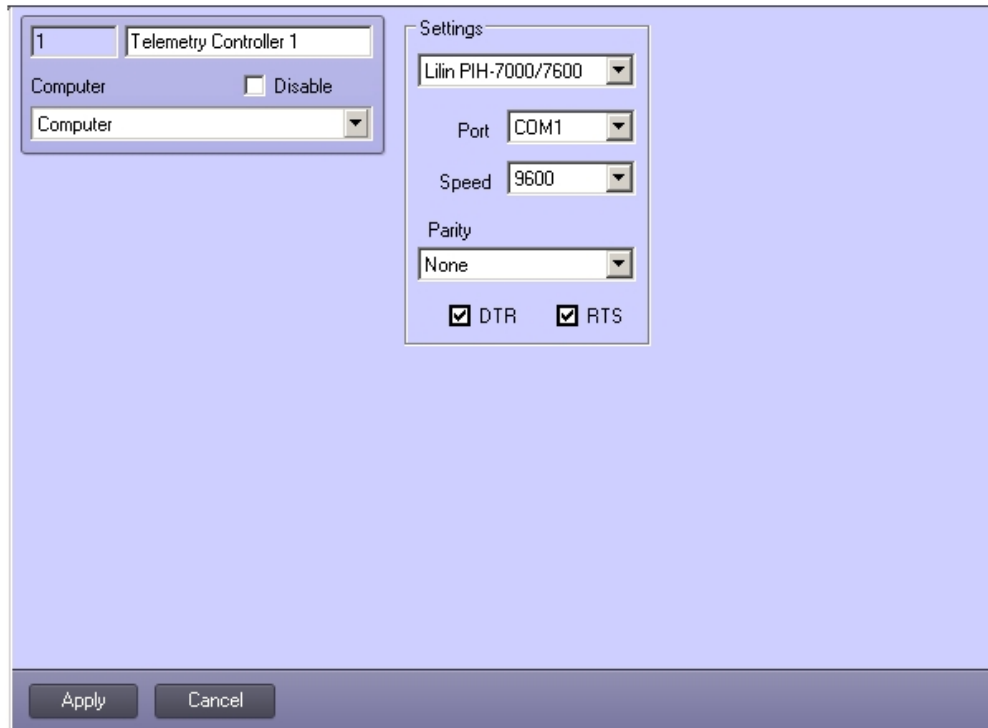

- b. Specify the **Lilin PIH-7000/7600** communication protocol.



Note.

In order to transmit directly data to Lilin cameras connected via a serial port, select the **Lilin PIH-7000/7600 Direct** communication protocol. However, the full functionality of these cameras can be used, even what is not supported by *Intellect*.

- c. In the **Port** list specify the number of the serial (COM) port for connecting to the telemetry controller.
 d. Specify **9600** value for the **Speed** parameter.
 e. Specify **None** value for the **Parity** parameter.
 f. Set the **DTR** and **RTS** checkboxes checked.
2. Create the **Control panel** object under the **Telemetry controller** object.
 3. Configure the **Control panel** object as described in [Telemetry control panel configuration](#) section.

Lilin PIH-800III telemetry control panel is now configured in *Intellect*.

Using Lilin PIH-800III telemetry control panel

Some of *Lilin PIH-800III* telemetry control panel's keys correspond to standard functions in *Intellect*.



Note.

The functionality of these keys is also described in the reference documentation on *Lilin PIH-800III* control panel.

Key	Function
ZOOM IN / ZOOM OUT	Increases/decreases the size of the image
FOCUS FAR / FOCUS NEAR	Increases/decreases the focal distance of the lens
IRIS O / IRIS C	Opens/closes the aperture
AUTOFOCUS	Sets the focal distance of the lens automatically
AUTOIRIS	Automatically selects the position of the aperture
AUTOPAN	Switches the pan head to auto-pan mode; or switches a dome camera to auto-patrol mode
PRESET	Switches to a preset; saves a preset
PRESET 1/2/3/4	Switches to preset 1/2/3/4

Some of *Lilin PIH-800III* control panel's keys can be used through the KEY_PRESSED event. *Intellect* receives the **KEY_PRESSED** event when these keys are pressed on Lilin PIH-800III telemetry control panel's keyboard.

Event	Message	Parameter	Description
KEY_PRESSED	A key was pressed	param0	Code the key that was pressed

The source of this event is the **Control panel** object (TELEMETRY_EXT). The event's documentation indicates the code of the key that was pressed (param0). The key code for entering a number (1, 2, or 4 digits) is equal to the number entered. A four-byte hexadecimal code is used for function keys.

Key	Code	Hexadecimal code
ESC	1769472	0x001B0000
LIGHT	655360	0x000A0000
CTRL1	851969	0x001A0000
CTRL2	851970	0x00090000
CLR	3604480	0x00370000
ENT	3538944	0x00360000
WIPER	786432	0x000C0000
SPRAY	720896	0x000B0000

No messages are sent to *Intellect* when the F1-F4, MON and CAM keys are pressed.

Control panel functions associated with the execution of actions in *Intellect* when events arrive from the control panel can be implemented using the following resources:

1. Scripts written in the JScript programming language (see [Programming Guide \(JScript\)](#) for more information on how to create scripts);

2. programs written in internal programming language in *Intellect*;
3. macros (see [Creating and using macros in Administrator's Guide](#) for more information).

Features of Panasonic WV-CU950 control panel configuration and operation

On the page:

- [Configuring Panasonic WV-CU950 control panel in INTELLECT™](#)
- [Features of Panasonic WV-CU950 control panel operation in INTELLECT™](#)
- [Example of JScript script](#)

Configuring Panasonic WV-CU950 control panel in INTELLECT™

Panasonic WV-CU950 control panel is connected using 4-wired version of RS-485 interface. Before connecting Panasonic WV-CU950 control panel, make sure that the MODE switches are set to the position corresponding to connection via RS-485 protocol: switches number 1 and number 5 are to be set to ON, the rest to OFF. See details on how to set switches in the reference documentation.

Configure Panasonic WV-CU950 control panel in *INTELLECT™* as follows:

1. Create the **Telemetry controller** object.
2. Configure the **Telemetry controller** object as follows:

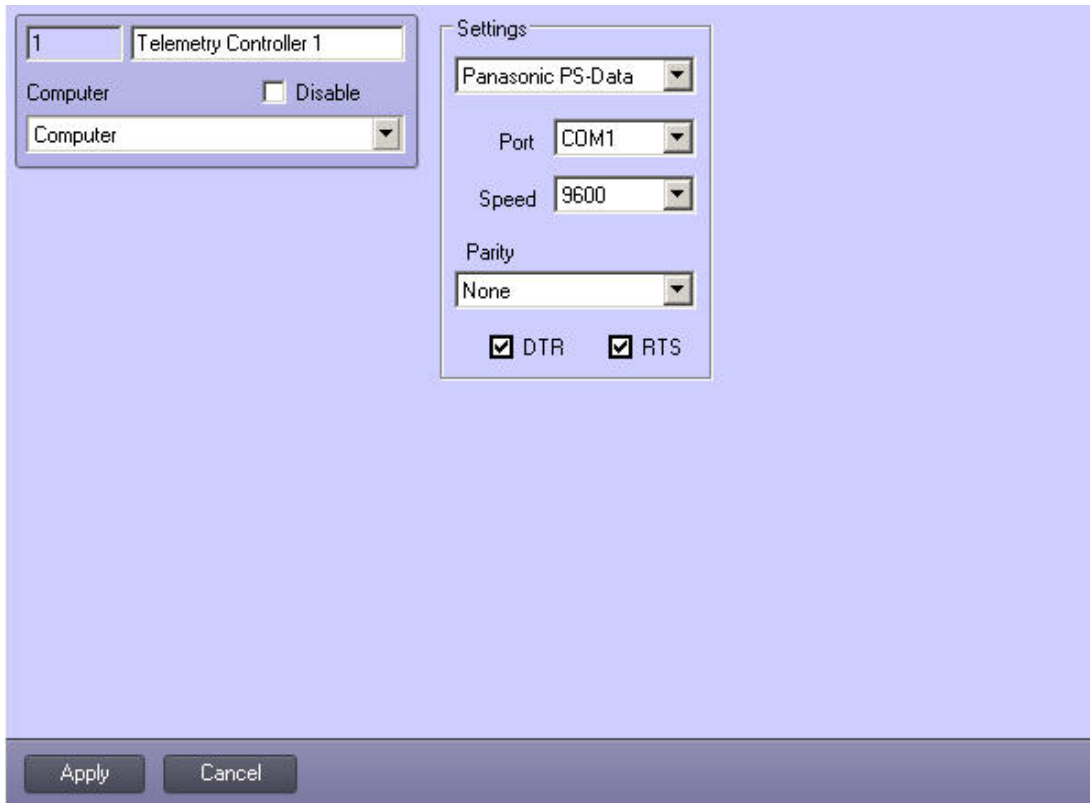

- a. Set the **Panasonic PS-Data** interface protocol.
 - b. Select the COM port in the **Port** list.
 - c. Set **19200** value for the **Speed** parameter.
 - d. Set the **None** value for the **Parity** parameter.
 - e. Set the **DTR** and **RTS** checkboxes checked.
3. Create the **Control panel** system object under the **Telemetry controller** object.
 4. Configure the **Control panel** object as described in [Configuring Control panel](#) section.

Panasonic WV-CU950 control panel is now configured in *INTELLECT™*.

Features of Panasonic WV-CU950 control panel operation in INTELLECT™

Pressing the key on Panasonic WV-CU950 control panel there is **Key pressed** or **Key released** message in *INTELLECT™*.

Description of 'Key pressed' and 'Key released' messages:

Event	Message	Parameter	Description
KEY_PRESSED	Key pressed	param0	Code of pressed key
KEY_RELEASED	Key released	param0	Code of released key

The **Cotrol panel** object (TELEMETRY_EXT) is the source of these events. In the comment to these events the code of pressed and released key is specified.

Key codes of Panasonic WV-CU950 control panel:

Key	Key code	Key	Key code
1	'1'	30	'T'
2	'2'	31	'U'
3	'3'	32	'V'
4	'4'	33	'W'
5	'5'	34	'X'
6	'6'	35	'Y'
7	'7'	36	'Z'
8	'8'	37	'a'
9	'9'	38	'b'
10	'0'	39	'c'
11	'A'	40	'd'
12	'B'	41	'e'
13	'C'	42	'f'
14	'D'	43	'g'
15	'E'	44	'h'
16	'F'	45	'i'
17	'G'	46	'j'
18	'H'	47	'k'
19	'I'	48	'l'
20	'J'	49	'm'
21	'K'	50	'n'
22	'L'	51	'o'
23	'M'	52	'p'
24	'N'	53	'q'
25	'O'	54	'r'
26	'P'	55	's'
27	'Q'	56	't'

28	'R'	57	'u'
29	'S'		

When the position of Panasonic WV-CU950 joystick is changed, then there is the **Position changed** message.

Description of Position changed message:

Event	Message	Parameter	Description	Value range
MOVED	Position changed	param0	Offset value	JogDial -1.. 1; shuttle -6..6
		device	Type of control-gear	0 – JogDial, 1 – shuttle

Functions of control panel related to pressing keys can be performed with the help of following:

1. scripts in JScript (see details on how to create scripts in [Programming Guide \(JScript\)](#));
2. programs in internal language in Intellect;
3. macros (see details in [Administrator's Guide, Creating and using macros](#) section).

The following special features are available for Panasonic WV-CU950 control panel using macros:

1. **Clear screen** – allows clearing the device screen.
2. **Type text** (set by Y coordinate, Text and Indication parameters) – displaying text with certain position and indication on the device screen.
3. **Set alarm** (set by Audio alarm parameter). Set alarm signal type.
4. **Switch on relay** (set by Relay identifier parameter). This command allows switching on the indicator.
5. **Switch off relay** (set by Relay identifier parameter). This command allows switching off the indicator.
6. **Reboot** (set by Reboot type parameter). Allows rebooting the device immediately or after a time period.

Example of JScript script

The file with JScript can be found [here](#). It allows assigning actions to Panasonic WV-CU950 control panel keys:

Key	Function
K	Continuous playback/pause
J	Stop playback
I	Switch to the archive playback mode/view live video mode
N	Clear control panel display
n	Enter key emulation
A	Set the Video surveillance monitor ID
B	Set the camera ID
D	Go to the preset

F	Record preset
i	Layout with 1 camera
j	Layout with 4 cameras
k	Layout with 9 cameras
l	Layout with 16 cameras
Shifting wheel of rotary control	Rewind/fast forward playback
Shifting frame-by-frame wheel	Maximize/minimize the Surveillance window

Features of Samsung SSC-2000 control panel configuration and operation

Configure Samsung SSC-2000 telemetry control panel in *Intellect* as follows:

1. Create the **Telemetry controller** object.
 - a. Configure the **Telemetry controller** object as follows:

The screenshot shows a configuration window for a 'Telemetry Controller' object. The object name is 'Telemetry Controller 1'. Under the 'Settings' section, the following values are configured:

- Protocol: Samsung
- Port: COM1
- Speed: 9600
- Parity: None
- DTR:
- RTS:

 The window also includes a 'Computer' dropdown set to 'Computer' and a 'Disable' checkbox which is unchecked. 'Apply' and 'Cancel' buttons are located at the bottom of the dialog.

- b. Specify the **Samsung** communication protocol.
- c. In the **Port** list, select the number of the serial (COM) port for connecting to the telemetry controller.
- d. Specify **9600** value for the **Speed** parameter.
- e. Specify **None** value for the **Parity** parameter.
- f. Set the **DTR** and **RTS** checkboxes checked.

2. Create the **Control panel** object under the **Telemetry controller** object.
3. Configure the **Control panel** object as described in [Telemetry control panel configuration](#) section.

Samsung SSC-2000 telemetry control panel is now configured in *Intellect*.

Features of Everfocus EKB-200 control panel configuration

Configure *Everfocus EKB-200* telemetry control panel in *Intellect* as follows:

1. Create the **Telemetry control panel** object.

Note.
You can leave default settings of the **Telemetry control panel** object.

2. Create the **Control panel** object.
3. Select **Everfocus EKB-200** in the **Port** field (1).

The screenshot shows a configuration window for a control panel. The window title is "Control panel 1" with a small "1" in the top right corner. On the left, there is a "Telemetry Controller" section with a "Disable" checkbox and a dropdown menu currently showing "Telemetry Controller 1". On the right, there is a "Settings" section. The "Port" dropdown menu is set to "EverFocus EKB200" and is highlighted with a red box and a "1" next to it. Below "Port" are "Rate" (set to 9600) and "Parity" (set to None) dropdown menus. There are two checked checkboxes: "DTR" and "RTS". Below these is a "Priority" section with a dropdown menu set to "Low priority". At the bottom of the window, there is a "2" and two buttons: "Apply" and "Cancel".

Note.
As the control panel is connected to the computer via USB, then you can leave default **Speed**, **Parity**, **DTR** and **RTS** settings.

4. To apply the changes click the **Apply** button (2).

Everfocus EKB-200 telemetry control panel is now configured.

Features of Samsung SPC-7000 control panel configuration

On the page:

- [Configuring Samsung SPC-7000 control panel](#)
- [Example of script in JScript](#)

Configuring Samsung SPC-7000 control panel

Configure *Samsung SPC-7000* telemetry control panel in *Intellect* as follows:

1. Create the **Telemetry control panel** object.

Note. You can leave default settings of the **Telemetry control panel** object.

2. Create the **Control panel** object.

The screenshot displays the configuration window for a control panel. On the left, the object name is 'Control panel 1' and the 'Telemetry Controller' is set to 'Telemetry Controller 1'. The 'Settings' section on the right includes: 'Port' set to 'Samsung SPC 7000', 'Rate' set to '9600', 'Parity' set to 'None', and both 'DTR' and 'RTS' checkboxes checked. The 'Priority' is set to 'Low priority'. At the bottom of the window, there are 'Apply' and 'Cancel' buttons.

3. Select **Samsung SPC-7000** in the **Port** field (1).

Note.

As the control panel is connected to the computer via USB, then you can leave default **Speed, Parity, DTR** and **RTS** settings.

- To apply the changes click the **Apply** button (2).

Samsung SPC-7000 panel is now configured.

Example of script in JScript

The [link](#) provides the file containing the script on JScript, which allows assigning actions to the keys of the *Samsung SPC-7000* telemetry control panel as in the manufacturer's manual.

Configuring PTZ IP cameras

Configuration of PTZ IP cameras differs from that of other PTZ devices.

PTZ IP cameras are connected via the local net via the TCP/IP transport protocol. Uniform communication protocol is used for all PTZ IP cameras.

Configure the **Telemetry Controller** object as follows:

- Go to the **Hardware** tab in the **System settings** dialog box (1).
- Create the **Telemetry Controller** system object under the **Computer** object or select the relevant object in the **Hardware** tab of the **System settings** dialog box (2).

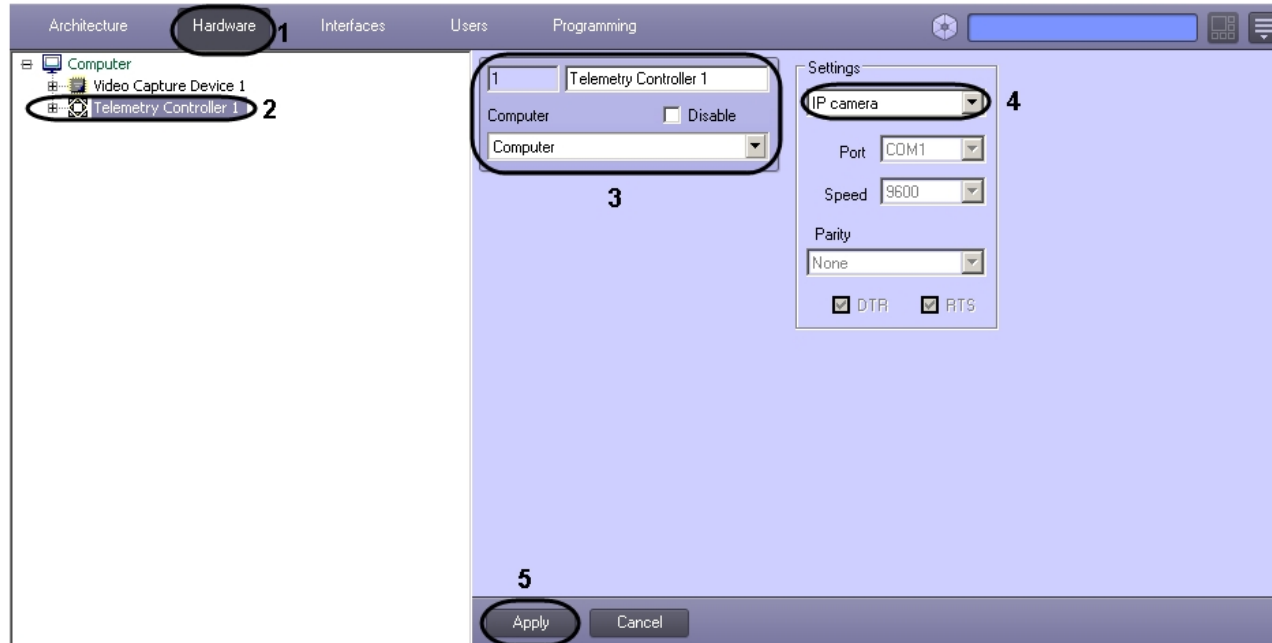

- Specify the ID, the name of the **Telemetry Controller** object and select the Server connected with the PTZ device (3).
- Select the data exchange protocol in the list. To use TCP/IP protocol for the data exchange with a PTZ IP camera, select **IP camera** as the protocol (4).

Note

When the **IP camera** item is selected on the **Settings** panel of the **Telemetry Controller** object, the other settings cannot be changed.

**Note**

If **Bosch VG5 AutoDome 700 Series** camera is in use, select the **Bosch-Autodome 1.0** protocol, for **Bosch VG4 AutoDome** and **Bosch VG5 AutoDome 800 Series** cameras select **Bosch-Autodome 4.0**.

5. To save all the changes click the **Apply** button (5).

**Note**

The **PTZ device** object configuration for PTZ IP camera control is the same as for control over PTZ devices when they are connected via the Server's COM port.

Configuring control of PTZ IP camera using the control panel

To control the PTZ IP camera using the control panel connected via COM-port create two **Telemetry controller** objects:



1. With the **Control panel** child object. Configure the **Telemetry controller** object depending on connected control panel as described in the corresponding section, see [Configuring Control panel](#).
2. With the **PTZ device** child object. Configure the **Telemetry controller** as described in the [Configuring PTZ IP cameras](#) section, and configure the **PTZ device** child object as described in the [Configuring PTZ devices in INTELLECT™](#) section.

Features of Vivotek Panoramic PTZ configuration

Vivotek Panoramic PTZ functional supports Vivotek SF8172 and Vivotek SF 8172V fish-eye cameras and Vivotek SD8362E PTZ camera.

Information on how to install these cameras and configure connection between them for proper operation of Vivotek Panoramic PTZ functional is given in the official documentation that is available on the Vivotek's web-site: <http://www.vivotek.com/panoramic%20ptz/>

For Vivotek Panoramic PTZ functional operation in the object tree create and configure the following objects corresponding to connected cameras:

1. Two **Video Capture Device** objects (information on how to configure these objects is in the [Configuring video acquisition from IP devices](#) section).
2. Two **Camera** objects under the **Video Capture Device** objects corresponding to connected cameras.
3. Two **Telemetry controller** objects (information on how to configure these objects is in the [Configuring PTZ IP cameras](#) section).
4. Two **PTZ device** objects under the **Telemetry controller** objects, corresponding to created cameras (information on how to configure these objects is in the [Configuring PTZ devices in INTELLECT™](#) section).



It is also required to configure **Monitor** and **Telemetry control panel** interface objects to control PTZ devices (see [Configuring the Monitor for telemetry control](#) and [Telemetry control panel configuration](#) sections).

When all required objects are configured, telemetry control on Fish-eye cameras using AreaZoom and Point&Click functions are available (detailed information on how to use these functions is given in the [Mouse PTZ control](#) section of [Operator's Guide](#) document).

Telemetry control panel configuration

Telemetry control panel is an interface object for PTZ device control. The telemetry panel interface is the same for all PTZ devices.

Create and configure the Telemetry control panel as follows:

1. Go to the **Interfaces** tab in the **System settings** dialog box (**1**).
2. Create the **Telemetry control panel** object under the **Display** object or select the relevant object in the **Interfaces** tab of the **System settings** dialog box (**2**).

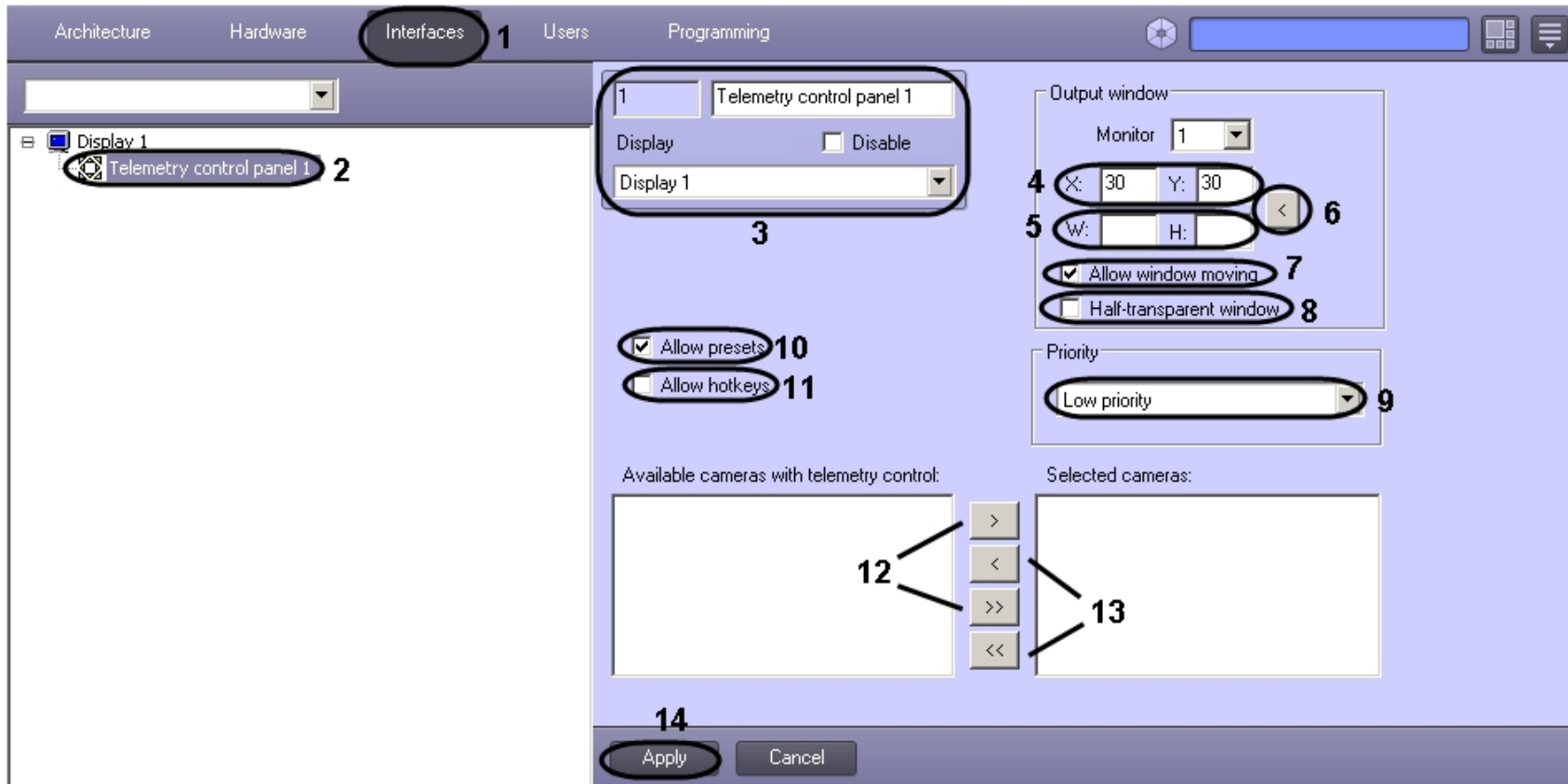

3. Specify the ID, the name of the **Telemetry control panel** object and select the **Display** object under which the **Telemetry control panel** object is created (3).
4. Change the **X** and **Y** coordinates of the telemetry panel position on the screen in the relevant fields. The **X** and **Y** values correspond to the screen coordinates of the top left corner of the telemetry control panel, and are shown as percentage of the horizontal and vertical screen sizes correspondingly (4).
5. Specify the dimensions of the **Telemetry control panel** interface object: the **W** (window width) and **H** (window height). Dimensions are shown as percentage of the horizontal and vertical screen sizes correspondingly (5).

Note

The < button (6) is used for automatic input of the current object coordinates specified by the user when using the **Telemetry control panel**.

6. By default, the telemetry control panel can be dragged over the screen. To fix the telemetry control panel position, set the **Allow window moving** checkbox unchecked (7).
7. By default, the telemetry panel is opaque. To display interface objects on the same screen with the telemetry control panel, set the **Half-transparent** checkbox (8).
8. If it is necessary to change the PTZ control priority via the **Telemetry control panel**, select the relevant item in the **Priority** list (9).
9. By default, the Operator is allowed to save the presets of PTZ device (presets of the camera position). To save presets, use the digital buttons on the **Presets** panel. To forbid the Operator to save the presets, set the **Allow presets** checkbox unchecked (10).
10. Set the **Allow hotkeys** checkbox checked if it is necessary to control PTZ device via the keyboard (11).
11. Move the names of the cameras equipped with PTZ devices to the **Selected cameras** list. These cameras will be controlled by the **Telemetry control panel** object. You can move the selected cameras in turn, if you click the one-arrow button or move all cameras if you click the two-arrow button (12).
12. Move the camera names from the **Selected cameras** list to the **Available cameras with telemetry control** list. These cameras will not be controlled by the **Telemetry**

control panel object. To move the selected cameras in turn, click the one-arrow button; to move all cameras, click the two-arrow button (13).

13. To save the changes click the **Apply** button (14).

Creating and configuring the Operator query panel for telemetry control

INTELLECT™ provides the PTZ control option using the **Operator query panel** interface object. The **Operator query panel** interface object is an individual user dialog box with the relevant elements to control a certain type of PTZ device.

The unique control panel is designed by the PTZ device vendor and is bundled with the PTZ software. The files of the unique PTZ control panels are stored in the **Program** folder of the *INTELLECT™* installation directory.

Create and configure the **Operator query panel** as follows:

1. Open the **Programming** tab in the **System settings** dialog box (1).
2. Create a **Macro** object under the **Macros** object in the **Programming** tab (2). Specify the object's ID and name.



Note

The **Macro** object is necessary to refer to *INTELLECT™* core and to display the **Operator query panel** on the screen.

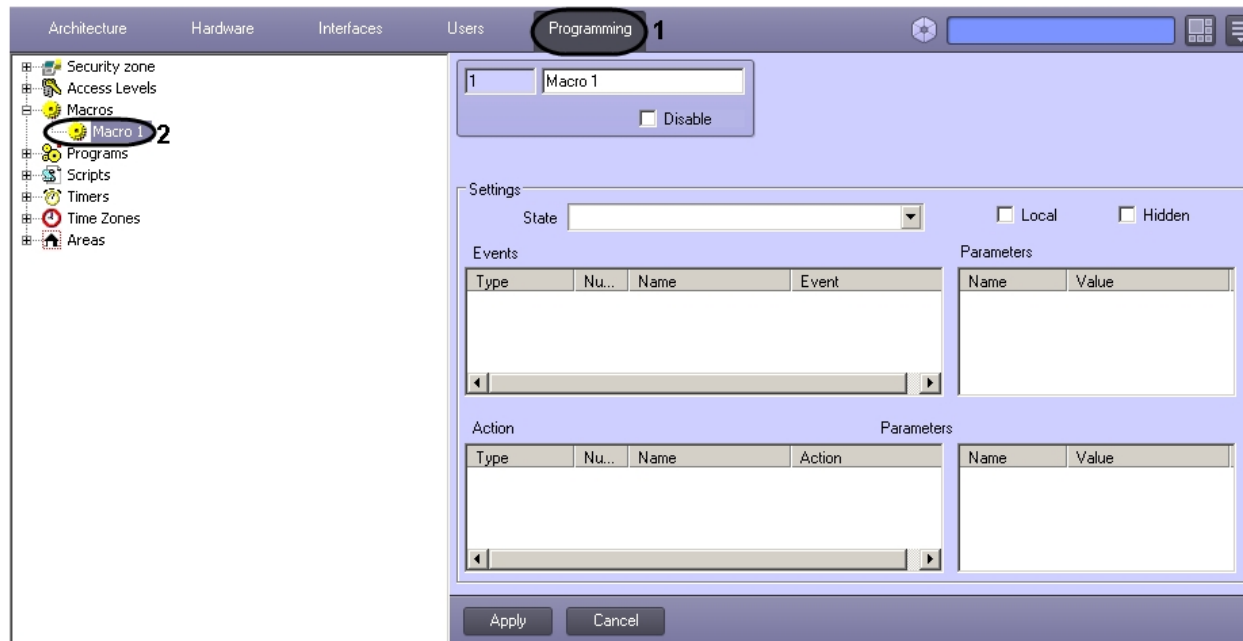

3. Open the **Hardware** tab in the **System settings** dialog box (3).
4. Create the **Operator query panel** object under the **Computer** object in the **Hardware** tab (4).

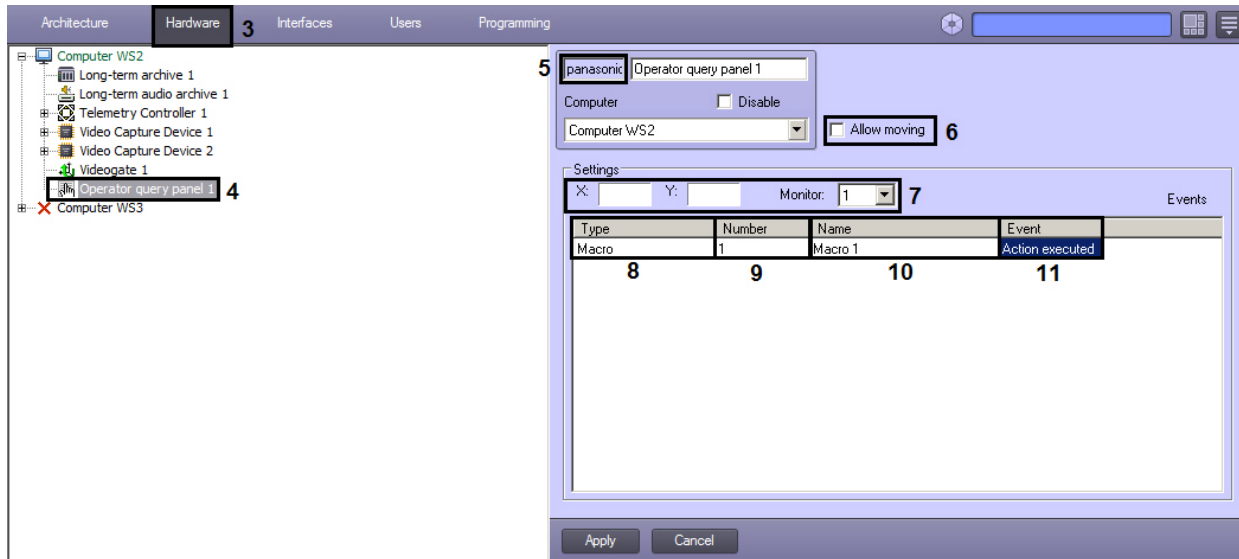

5. Specify the file name (without extension) of the dialog box, used for PTZ device control, in the ID field (5). The necessary files are stored in the **program** folder of the **INTELLEC T™** installation directory.

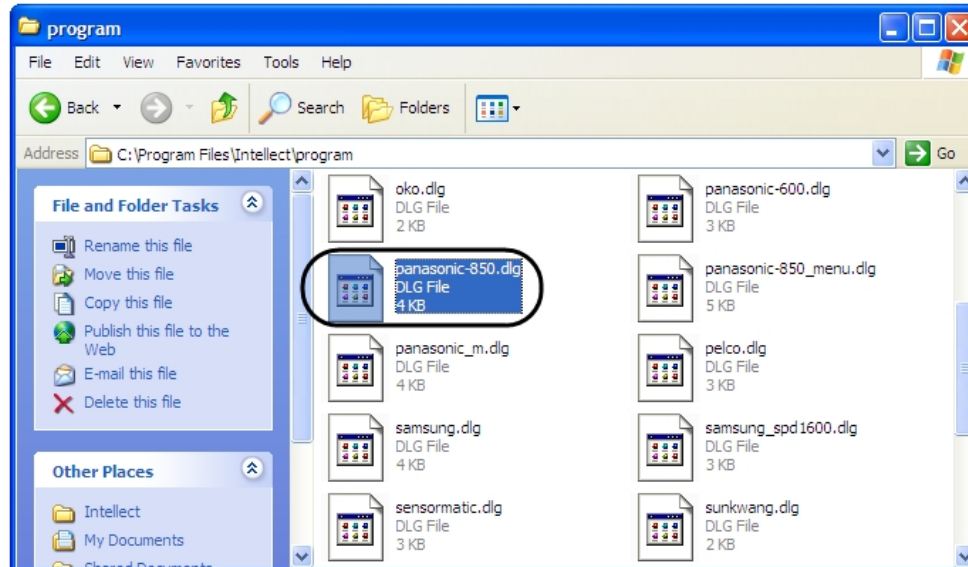

6. To activate the moving option for the **Operator query panel** object, set the **Allow moving** checkbox checked (6).
7. Specify the **X** and **Y** coordinates of the **Operator query panel** position on the screen in the relevant fields. The **X** and **Y** settings correspond to the screen coordinates of the top left corner of the **Operator query panel** and are shown as percentage of the horizontal and vertical screen sizes correspondingly (7).
8. Select the type of the **Macro** objects in the list of objects and events (8).
9. Specify the ID of the **Macro** object, created to call up the **Operator query panel** (9).

10. The name of selected **Macro** object is automatically displayed in the **Name** column (10).
11. Select the **Action executed** item in the list of possible events (11).
12. To save the changes click the **Apply** button (12).

Configuring the Monitor for telemetry control

INTELLECT™ provides the PTZ control option using the Monitor windows that correspond to the cameras equipped with PTZ devices. In this case the PTZ device is controlled by the mouse using the viewing tiles of PTZ cameras.

PTZ control function via the viewing tiles corresponding to the cameras equipped with PTZ devices, is always enabled and can't be disabled. To access PTZ control via the viewing tile, do the following:

1. On conditions that the equipment is functional, configure the **PTZ device** object related to the selected PTZ device.
2. Select the PTZ control priority for the viewing tile in the settings of the **Monitor** object.

Additional configuration of telemetry control option is not required.

Configuring the joystick for telemetry control

Joystick setting procedure

If the joystick is connected to the Server and configured in Windows OS, then *INTELLECT™* automatically activates the joystick telemetry control option. The option is valid for all PTZ devices connected to the Server and configured in *INTELLECT™*.

Generally the joystick configuration contains the following stages:

1. Testing joystick handle functioning in *INTELLECT™*. This procedure is described in the [Testing joystick functioning](#) section. Configuration of issuing the command to PTZ devices using the joystick keys. For configuration instructions see the [Assigning commands to joystick buttons for telemetry control](#) section.
Testing joystick keys functioning in *INTELLECT™*. The procedure is similar to testing joystick handle functioning. For a detailed description see the [Testing joystick functioning](#) section.

The following functions are available by default and do not require additional configuration:

1. Rotation of cameras equipped with PTZ devices is performed by inclining the joystick handle;

Note

Joystick threshold corresponds to the **Joystick Threshold** string parameter and is set in the HKLM\SOFTWARE\ITV\Intellect\Telemetry register of the Windows OS. By default Joystick Threshold=1, this parameter can possess values from 0 and more. The bigger the value, the less sensitive the joystick is, the best value is selected empirically.

2. Zooming option is performed by turning a joystick handle around its vertical axis.

The zooming option is available only for joysticks with Z axis, for example Axis 295. This axis is formed by joystick handle's angles of rotation.

Z axis is enabled by default and corresponds to the value of **Zenable=1** string parameter in the HKLM\SOFTWARE\ITV\INTELLECT\Telemetry register of the Windows OS.

Attention!

The coordinate of joystick Z axis is to be automatically zeroized after every zooming for proper telemetry control. Otherwise Z axis is to be disabled by setting the Zenable=0 parameter in the HKLM\SOFTWARE\ITV\INTELLECT\Telemetry section.

**Note**

Z axis is to be disabled when the Logitech USB joystick is used.

Testing joystick functioning

Before configuring and using a joystick to control PTZ devices, test its functioning in *INTELLECT™*.

To test the joystick functioning in *INTELLECT™*, do the following:

1. Make sure that PTZ devices are connected, configured and operate properly in *INTELLECT™*.
2. Display the video surveillance monitor on the screen.
3. Check if cameras equipped with PTZ devices are displayed on the video surveillance monitor. If not, change the layout of viewing tiles.
4. Activate the selected viewing tile by left clicking it.
5. Display the telemetry module debug window. To display the telemetry module debug window, double click with the left button upon the window icon in the notification zone of the Windows OS menu.



6. As a result the telemetry module debug window is displayed.

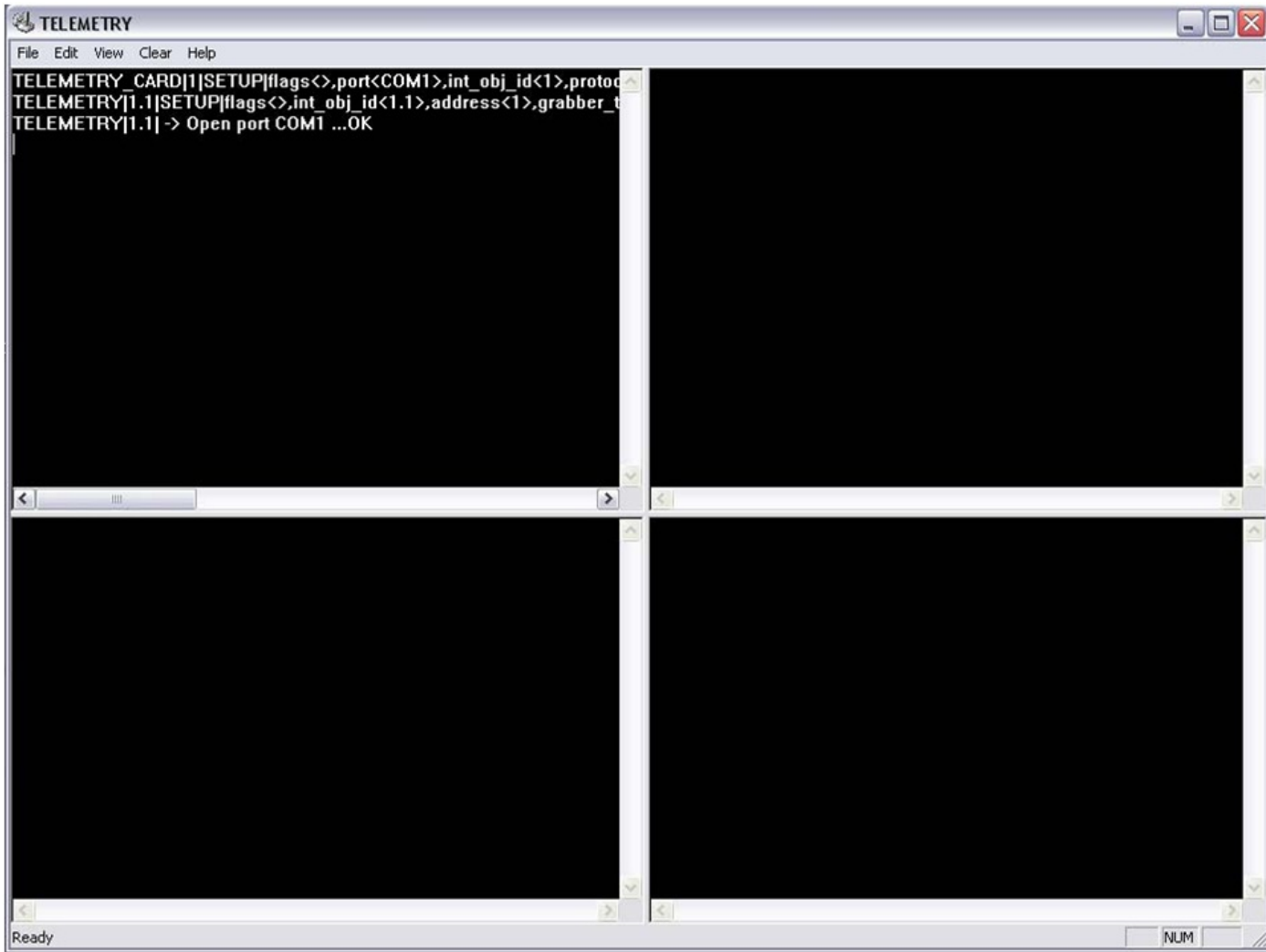

7. To test the joystick handle functioning, rotate it in different directions.
8. To test the joystick buttons functioning, push them in turn.
9. If the joystick operates properly, the relevant commands are displayed in the debug window.

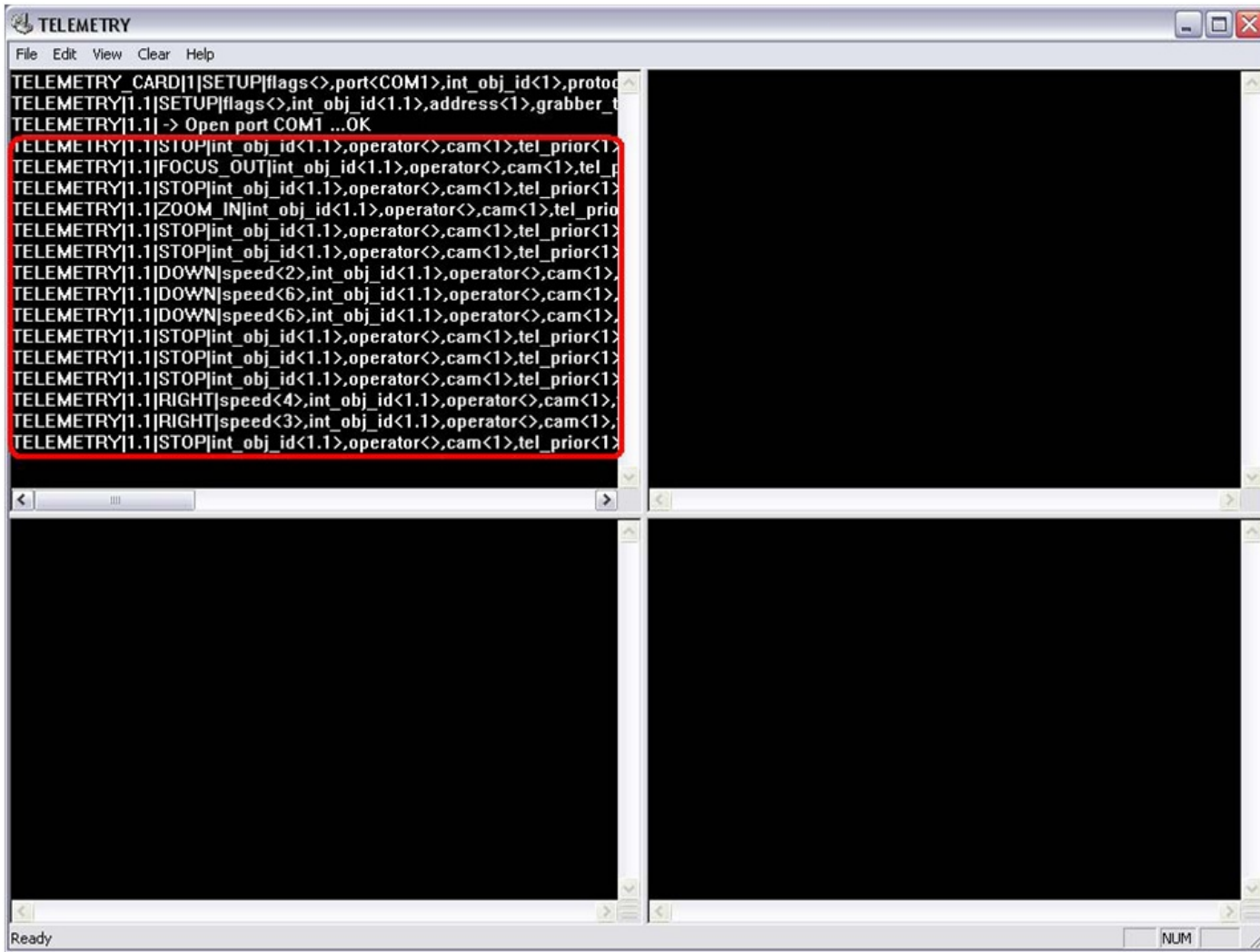

10. If there are no commands in the debug windows, then the joystick does not operate in *INTELLECT™*. Check its connection to the computer and its data exchange driver settings in the Windows OS.

The joystick functioning is now tested.

Assigning commands to joystick buttons for telemetry control

Certain commands can be assigned to the joystick buttons in order to issue default commands to PTZ devices.

This feature is available for USB joysticks only and not related to telemetry control panels.

To assign the commands to joystick buttons, do one of the following:

1. Edit the Windows OS registry (see [Assigning commands to joystick buttons using Registry Editor](#)).
2. Set up the Monitor (see [Assigning commands to joystick buttons using the Monitor](#)).

Note. Some PTZ devices do not react to commands issued by the joystick buttons used for video camera rotation. In this case you can rotate a video camera using a joystick handle.

Note. The **Patrol stop** macro acts only after the **Patrol** macro. I.e. if you run the **Patrol** macro, restart *Intellect* and then try to run the **Patrol stop** macro, the latter one will not be run.

Assigning commands to joystick buttons using Registry Editor

Here is a short list of actions that are to be performed in order to configure the joystick buttons. Detailed information on how to use the Windows OS registry can be found in the [Appendix 3. Relevant information on using Windows operating system section of Administrator's Guide](#).

Assign commands to the joystick buttons in the Windows OS registry as follows:

1. Open the **TELEMETRY** folder of the **HKEY_LOCAL_MACHINE -> SOFTWARE -> ITV -> Intellect** registry branch (**HKEY_LOCAL_MACHINE -> SOFTWARE -> Wow6432 Node -> ITV -> Intellect** for 64-bit system).
2. Add a string parameter to the **TELEMETRY** folder.
3. Assign the name to the string parameter, identical to the number of the joystick button in the Windows OS.

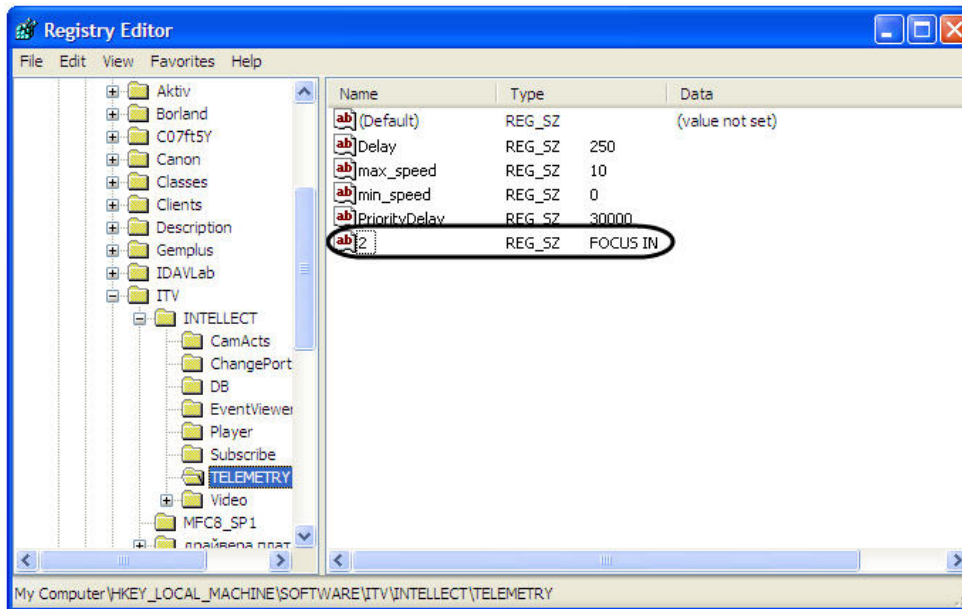

**Note.**

To define the numbers of the joystick buttons in the Windows OS, use the **Game devices** application.

- Assign the value to the string parameter, identical to the name of the command executed by the PTZ device in INTELLECT™ (the value is to be entered in uppercase). Available commands in INTELLECT™ are listed in the table below:

Symbol	Command
AUTOFOCUS_ON	Activate the autofocusing option.
AUTOPAN_END_P	Set the autopan endpoint.
AUTOPAN_START	Start the autopan.
AUTOPAN_START_P	Set the autopan start point.
AUTOPAN_STOP	Stop the autopan.
CLEAR_PRESET	Clear the selected preset.
D2OFF	Disable additional dynamic settings for Panasonic PTZ cameras for improving an analog video signal.
D2ON	Enable additional dynamic settings for Panasonic PTZ cameras for improving an analog video signal.
DOWN	Rotate the camera lens down.
FOCUS_IN	Focusing the image in.
FOCUS_OUT	Focusing the image out.
FOCUS_STOP	Stop focusing the image in/out.
GO_PRESET.N	Rotate the video camera to the position set in N preset.
HOME	Rotate the video camera to the initial (home) position.
IRIS_CLOSE	Close the iris diaphragm.
IRIS_OPEN	Open the iris diaphragm.
IRIS_STOP	Stop the iris diaphragm.
LEFT	Rotate the camera lens left.
LEFT_DOWN	Rotate the camera lens left and down.
LEFT_UP	Rotate the camera lens left and up.
PATROL_LEARN	Start the programming procedure of patrolling by learning the video camera behavior.
PATROL_PLAY	Start patrolling.
PATROL_STOP	Stop patrolling.

RIGHT	Rotate the camera lens right.
RIGHT_DOWN	Rotate the camera lens right and down.
RIGHT_UP	Rotate the camera lens right and up.
SET_PRESET	Save the current position of the video camera in the selected preset.
STOP	Stop the the camera lens rotation.
UP	Rotate the camera lens up.

Repeat steps 2-4 for each joystick button to which the command is to be assigned.

Joystick buttons are now configured.

Assigning commands to joystick buttons using the Monitor

The default commands assigned to joystick buttons are presented in the table below:

Button	Default command
1	Optical zoom in
2	Optical zoom out
3	Focus +
4	Focus -
5	Enable auto focus
6	Not specified
7	Open diaphragm
8	Close diaphragm
9	Not specified
10	Not specified

Assign commands to joystick buttons using the Monitor as follows:

1. Go to the **Interfaces** tab (1).

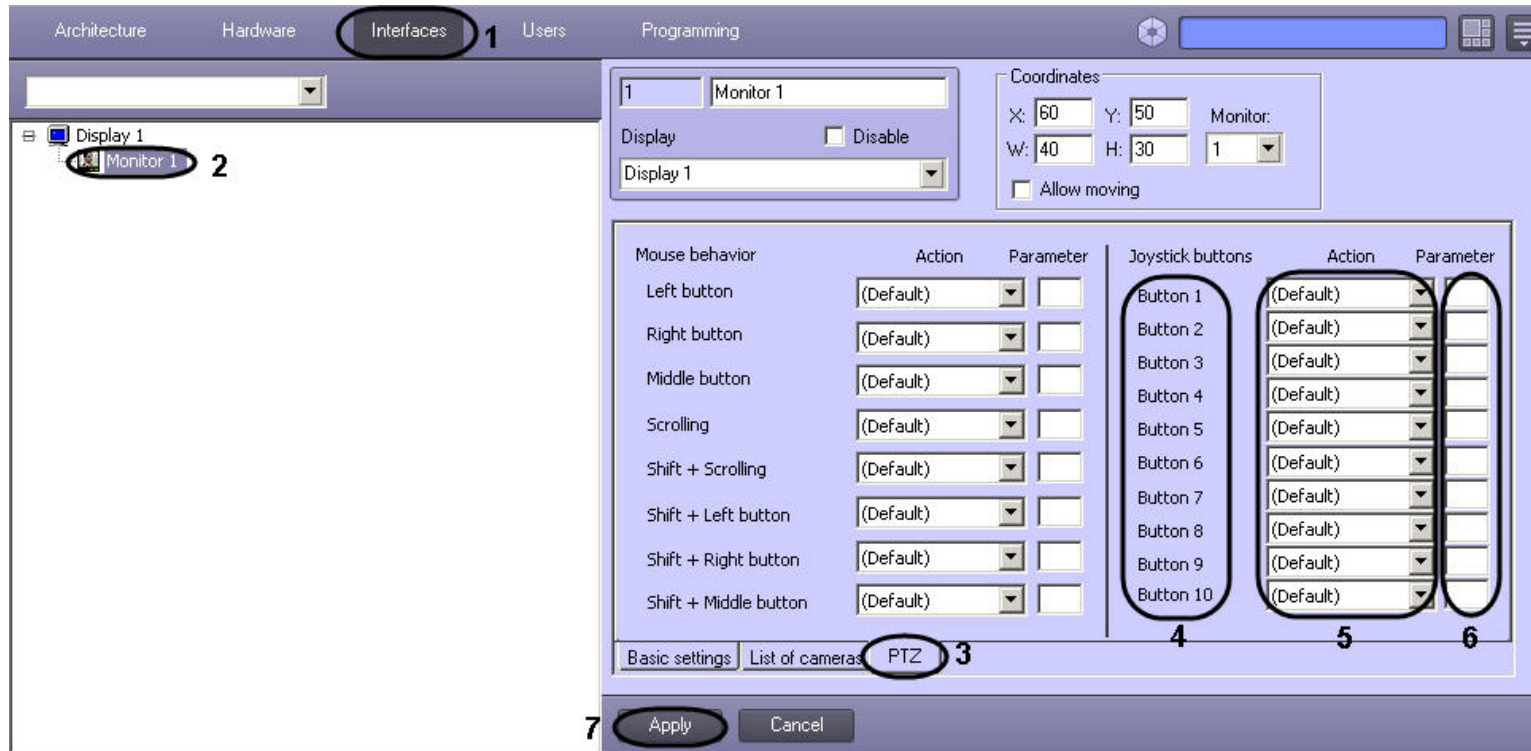

2. Go to settings panel of the **Monitor** object which is in use to display video from the camera to which the PTZ device is assigned (2).
3. Go to the **PTZ** tab (3).
4. Joystick buttons are listed in the **Joystick buttons** column (4). Buttons numeration depends on the joystick model and is described in the reference documentation.
5. In the **Action** dropdown list select a reaction of the **PTZ device** object next to the required button. This reaction will be performed when clicking the button (5).
6. In case of the selected reaction requires specifying the parameter, e.g. preset number or speed, specify the value of this parameter in the **Parameter** field (6).
7. To save changes click the **Apply** button (7).

Note. Settings of the Monitor from which controlling is performed are in use if different actions are assigned to one button in several Monitors.

Joystick buttons are now configured.

Configuring the mouse buttons to control PTZ devices

It is possible to change commands of telemetry control for mouse buttons in *Intellect*.

Default actions assigned to mouse buttons and to buttons combinations are presented in the table below.

Note.

In Intellect 4.9.5 and later versions the PTZ control mechanism has been changed.

New control features are used by default and their description is given in the **New default action** column. If the previous PTZ control features are to be used, then set 0 value for the TelemetryMouseAlternative registry key – see [Registry keys reference guide](#).

Button/button combination	Old default action	New default action
Left button	Optical zoom in	-
Right button	Optical zoom out	-
Middle button	Auto changing of video camera objective orientation to the area on which the mouse button click was performed (Point&Click)	
Scrolling	Digital zoom	Optical zoom
Shift+Scrolling	Digital zoom	
Shift+Left button	Focus In	
Shift+Right button	Focus Out	
Shift+Middle button	Auto changing of video camera objective orientation to the area on which the mouse button click was performed (Point&Click)	

 **Note.**
See more info in [Mouse PTZ control](#) section.

Assign actions to mouse buttons as follows:

1. Go to the **Interfaces** tab of the **System settings** dialog box (1).

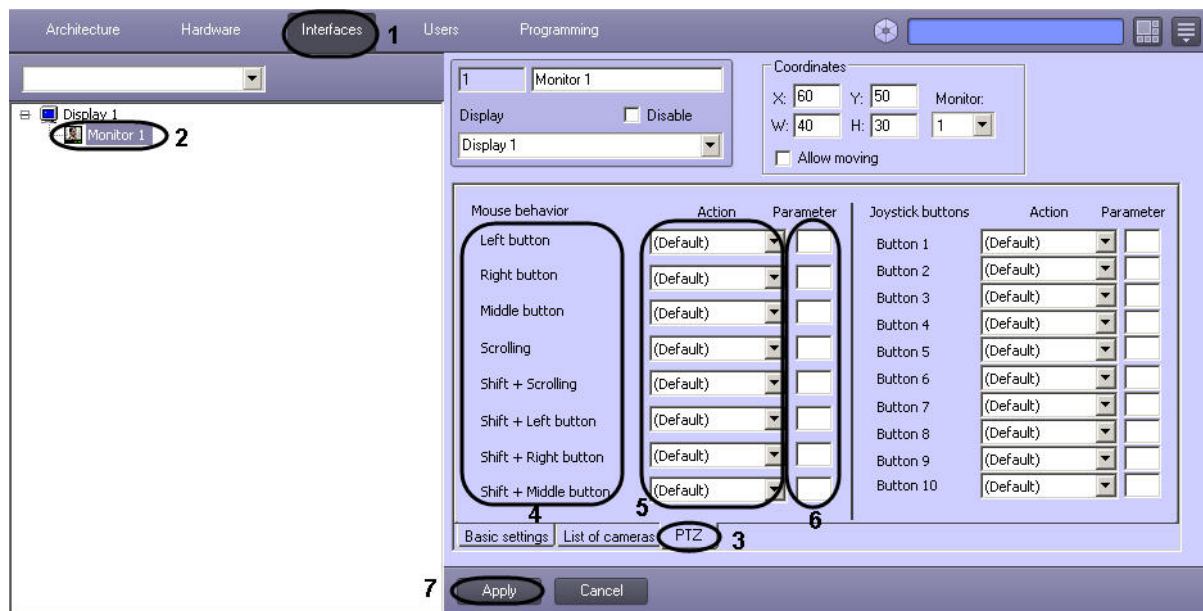

2. Go to settings panel of the **Monitor** object which is used to display video from the camera with which the PTZ device is connected (2).
3. Go to the **PTZ** tab (3).
4. Buttons and button combinations to which it is possible to assign telemetry commands are listed in the **Mouse behaviour** column (4).
5. In the **Action** dropdown list select the reaction of **PTZ device** object next to the required button. The reaction will be performed while clicking this button (5).
6. If the selected reaction requires specifying the parameter, e.g. preset number or speed, specify the value of this parameter in the **Parameter** field (6).
7. To save changes click the **Apply** button (7).

Note. Settings of the Monitor from which controlling is performed are in use if different actions are assigned to one button in several Monitors.

Mouse buttons are now configured.

Installing and configuring security system components guide.

CONCLUSION

More detailed information on the Intellect software package is presented in the documents titled:

1. [Operator's Guide](#);
2. [Programming Guide \(JScript\)](#).
3. [Administrator's Guide](#);

If while operating the given software product you have faced difficulties and problems, you are welcome to contact us. However before addressing us, we kindly ask you to answer the following questions:

1. What is the problem?

2. When did the problem occur and what had happened before it occurred?
3. Which conditions gave rise to the problem?

Remember, that the more detailed and precise information you give us, the faster our experts will resolve your problem.

We are striving to improve the quality of our products, and hence welcome any proposals and suggestions how to improve our software and documentation.

Please send your comments or requests concerning this Guide to the AxxonSoft Training and documentation development division at (documentation@itv.ru).

Appendix 1. Features of video capture card configuration

Drivers for video capture cards integrated into INTELLECT™

Drivers for video capture cards integrated into *INTELLECT™* are stored in the **Drivers** folder of the *INTELLECT™* installation directory (e.g., C:\Program Files\Intellect\Drivers). Structure of the **Drivers** folder is given in table.

Directory	Drivers for video capture cards	Platform supported
ITV\Fs5_6_8_16	FS5, FS6, FS8, FS16, FX2	x32, x64
ITV\FX116_416	FX116, FX416, MS416	x32, x64
ITV\Ws6	WS6	x32
ITV\Ws7	WS7, WS17	x32
TUAN\TW6802	SC200Q4 (FS15), SC200Q4 Low profile (FS115), SC300Q16 (FX4), SC300D16 (FX8), SC230N4, SC330Q16 (analogue of SC300Q16)*, SC330D16 (analogue of SC300D16)*	x32, x64
TUAN\CX2581	SC310N16 (FX16)	x32, x64
TUAN\AH8400	SC390N16 (WS16)	x32, x64
TUAN\TW5864	SC3B0N16 (WS216)	x32, x64
TUAN\SA7160	SC510N4 (FX HD4)	x32, x64
TUAN\TW2809	SC590N4	x32, x64

* The SC330Q16 and SC330D16 cards have the TW6816 microchip, however it is shown as TW6802 in the device manager.

Note
Drivers for Stretch (VRC6004, VRC6008, VRC6416, VRC7008L and VRC6404HD) video capture cards are stored in the **C:\Program Files\Common Files\AxxonSoft\Drivers\Stretch\x86** directory (**C:\Program Files (x86)\Common Files\AxxonSoft\Drivers\Stretch\x64** for 64-bit system).

Note
Drivers for HikVision DS-4016HCI(R) video capture card are stored in the **C:\Program Files\Common Files\AxxonSoft\Drivers\HikvisionBoard\x86** directory (**C:\Pro**

Features of video subsystem configuration

Features of video subsystem configuration are given in the table below:

Video capture device	Number of the Video capture device objects for one physical card	Maximum number of the Camera objects for one Video capture device object	Allocation of channel numbers between the Camera objects	Number of the Camera objects (in live mode) for the Video capture device object
FS5	1	16	1-16 (for each physical card)	1
FS6	4	4	1-16 (for each physical card)	1
FS16	4	4	1-16 (for each physical card)	1
FS8	8	2	1-16 (for each physical card)	1
FX2	2	4	1-8 (for each physical card)	1
SC200Q4 (FS15)	1	4	1-4 (for each physical card)	1
SC200Q4 Low profile (FS115)	1	4	1-4 (for each physical card)	1
SC230N4	4	1	randomly	1
SC300Q16 (FX4)**	4	4	1-4 (for each Video capture card object)	1
SC300D16 (FX8)**	8	2	1-2 (for each Video capture card object)	1
SC310N16 (FX16)	16	1	randomly	1
WS6	4	1	randomly	1
WS7	4	1	randomly	1
SC390N16 (WS16)	16	1	randomly	1
WS17	4	1	randomly	1
SC3B0N16 (WS216)	16	1	randomly	1
FX116***	1	16	1-16 (for each physical card)	8
FX416	1	16	1-16 (for each physical card)	16
MS416	1	16	1-16 (for each physical card)	16

Stretch (VRC6004)	1	4	1-4 (for each physical card)	4
Stretch (VRC6008)	1	8	1-8 (for each physical card)	8
Stretch (VRC6416)	1	16	1-16 (for each physical card)	16
Stretch (VRC7008L)	1	8	1-8 (for each physical card)	8
Stretch (VRC6404HD)	1	4	1-4 (for each physical card)	4
DS4016HCI(R)	1	16	1-16 (for each physical card)	16
SC510N4 (FX HD4)*	4	1	randomly	1
SC590N4	4	1	randomly	4
SC330Q16	4	4	1-4 (for each Video capture card object)	1
SC330D16	8	2	1-2 (for each Video capture card object)	1

*PCI channels are to be allocated between the **Video capture device** objects created for SC510N4 (FX HD4) video capture card, taking into account the numbers of external HDMI connectors indicated on the card.

** When a video subsystem is built using SC300Q16 (FX4) or SC300D16 (FX8) or SC330Q16 (analogue of SC300Q16) or SC330D16 (analogue of SC300D16) video capture card, take into account that each color of BNC video input of interface cable conforms with a certain PCI channel specified in the settings of the Video capture device object.

Value of PCI channel	Colour of BNC video input
00	Blue
01	Green
02	Yellow
03	Black
2nd interface cable	
04	Blue
05	Green
06	Yellow
07	Black

For example, if one SC300Q16 (FX4) video capture card is used and video cameras are connected to blue BNC video inputs, then the **Camera** objects under the **Video capture device** object correspond to these video cameras (with 00 value for PCI channel) in *INTELLECT™*.

 **Attention!** Specify the **min** value to the **Speed** parameter in the settings panel of the **Video Capture Device** object if more than 8 cameras are connected to FX116 card (see the [The Settings panel of the Video Capture Device object](#) section of the [Administrator's Guide](#) document). This value corresponds to 8 fps in the PAL format. Otherwise noise (distortions) on video can occur.

Features of audio subsystem configuration

Features of audio subsystem configuration are given in the table below:

Video capture device	Number of the Audio card objects for one physical card	Maximum number of the Microphone objects for one Audio card object	Allocation of channel numbers between the Microphone objects under one Audio card object
FS5 (FS 6)	1	2	#0 - #1
FS6 (FS 6)	4	2	#0 - #1
FS16 (FS 6)	4	2	#0 - #1
FS8 (FS 8)	8	2	#0 - #1
FX2 (FS 6)	2	2	#0 - #1
SC200Q4 (FS15, TW6802 PCI, Analog WaveIn)	1	1	only #0
SC200Q4 Low profile (FS115)	1	1	only #0
SC230N4	4	1	only #0
SC300Q16 (FX4, TW6802 PCI, Analog WaveIn)	4	1	only #0
SC300D16 (FX8, TW6802 PCI, Analog WaveIn)***	8	1	only #0
SC310N16 (FX16, CX2581 PCI, Analog WaveIn)	16	1	only #0
WS6 (WS 6)	4	2	#0 - #1
WS7 (WS 7)	4	2	#0 - #1
SC390N16 (WS16, AH8400 PCI, Analog WaveIn)	16	1	only #0
WS17 (WS 7)	4	2	#0 - #1
SC3B0N16 (WS216, TW5864 PCI, Analog WaveIn)	16	1	only #0
FX116 (SLFXR)	1	16	#0 - #15

FX416 (SLFXR)	1	16	#0 - #15
MS416(SLMSR)	1	32	#0 - #31
Stretch (VRC6008)	1	8	#0 - #7
Stretch (VRC6416)	1	16	#0 - #15
Stretch (VRC7008L)	1	8	#0 - #7
SC510N4 (FX HD4, SA7160 PCI, Analog WaveIn)*	4	1	only #0
SC590N4**	4	1	#0 - #1
SC330Q16	4	1	only #0
SC330D16	8	1	only #0

* PCI channels are to be allocated between the **Audio card** objects created for SC510N4 (FX HD4) video capture card, taking into account the numbers of external HDMI connectors indicated on the card.

** Audio input is performed via both SDI connectors and analog inputs. **Either** SDI or analog input can be used at the same time for each card. #0 channel corresponds to the SDI, and #1 – to the analog input. Therefore, it is possible to simultaneously connect audio to the card via either 4 SDIs, or 3 SDIs and one analog input, or 2 SDIs and 2 analog inputs.

Restart the *Intellect* to apply settings.

*** FS8 video capture card allows capturing 16 audio channels with digitization quality up to 32 kHz. Eight right (#1) channels are used to connect to external DB9-M connector.

Pinout of an audio port of FS8 card:

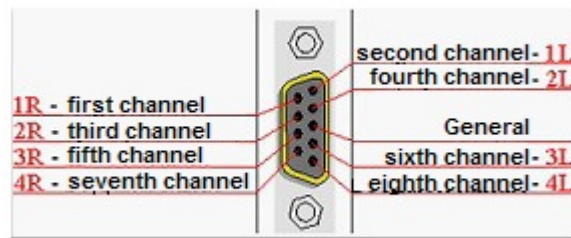

Eight left (#0) channels are used to connect to internal 6-pin connector using 8-channel audio cable. FS8 card with an audio cable:

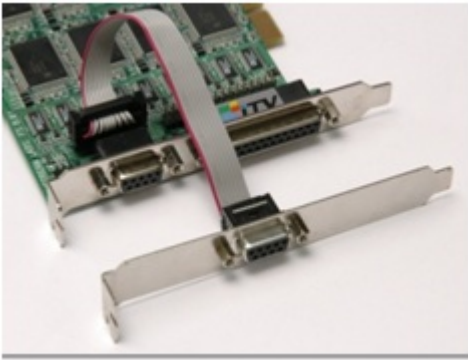

Pinout of an audio port of an audio cable:

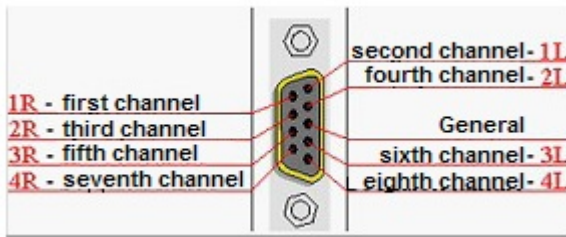

Optionally there is an adapter for DB9-M connector (audio input port on FS8 card) with 8 RCA-F connectors that make audio source connection easier.

⚠ Attention! Signs on audio cable connectors do not conform with numbers of card channels. Right channels are performed in DB9 connector, left channels are performed in DB9 cable.

Channels in DB9 connector:

Sign on audio cable connector	Number of a card channel
1R	1R
2R	3R
3R	5R
4R	7R
1L	2R
2L	4R
3L	6R

4L	8R
----	----

Channels in DB9 cable:

Sign on audio cable connector	Number of a card channel
1R	1L
2R	3L
3R	5L
4R	7L
1L	2L
2L	4L
3L	6L
4L	8L

Appendix 2. IP device configuration in the Windows OS

Configuration of IP devices by the example of Axis camera

IP-devices in Windows OS are configured with the software bundled with the network module.

To configure the IP device in Windows OS, the following software bundled with the device is in use:

1. software bundled with the network device package. This software allows:
 - a. searching for the network devices connected to the local network computers.
 - b. assigning initial IP addresses (without routing).



Note

An initial IP-address is required to enable access to the home pages of the devices installed on the embedded Web Servers.

2. The Web Server module of the network device. This module contains home pages of all connected network devices. The Web Server module allows:
 - a. configuring network devices taking into account routing.
 - b. configuring operation modes of the network devices with video and audio signals.
 - c. playing back video from the network devices in the standard Web-browser mode.

Searching for IP devices

The software package consists of various software including different utilities designed to search for the network devices of the same type connected to the local network computers.

IPUtility.exe utility is used to search for connected network cameras when Axis cameras are in use. IPUtility.exe utility is bundled with Axis cameras and is stored in the Axis installation software directory.

To search for Axis IP cameras connected to the local network computers, using the IPUtility.exe utility, do the following:

1. Select **Search** on the IPUtility.exe tools panel.

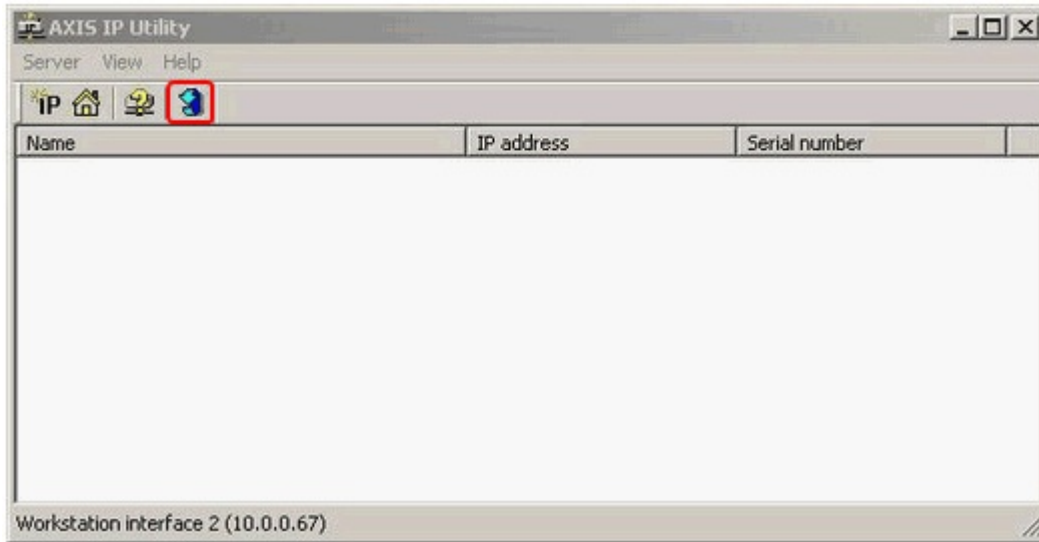

The search for Axis IP cameras starts as soon as the **Search** button is clicked.

2. The list of Axis IP cameras available in the local network is displayed in the IPUtility.exe window.

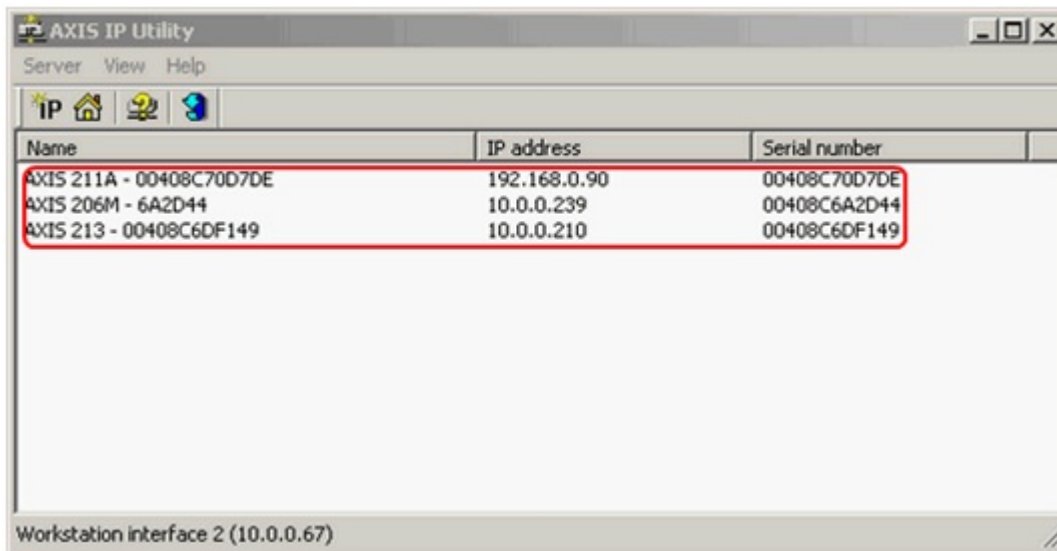

Assigning network addresses to IP devices

To ensure correct operation of the network devices within the local video surveillance system, their IP addresses are to be configured correctly. IP addresses are configured using the utilities bundled with the software kit.

Before assigning an IP address to the Axis network camera, do the following:

1. Make sure that the Axis network camera is connected to the mains and correctly connected to the telecommunication network.
2. Get a unique IP address from the network Administrator.
3. Make sure that the device displays its own MAC address correctly. The MAC address of Axis cameras is the same as the serial number of the camera.

Note
The examples below use a computer with 192.168.0.1 IP address, whereas an Axis camera is installed to 192.168.0.90 IP address. The MAC address for an Axis camera is 00408C70D7DE. The addresses given as an example are not to be used; always consult your network Administrator before assigning an IP address.

Note
Selecting an IP address to be assigned to an IP camera, keep in mind that the initial IP address of the camera connected for the first time is to correspond to the same subnetwork as the IP address of computer. Later on, if required, the IP address can be modified using the Web Server of the device.

To assign an IP address to the Axis network camera, do the following:

1. Check that the IP address to be assigned to the Axis network camera is not used by any other devices.
The IP address in Windows OS is checked using the command line. To display the command line on the monitor select the **Run** command in the **Start** menu.

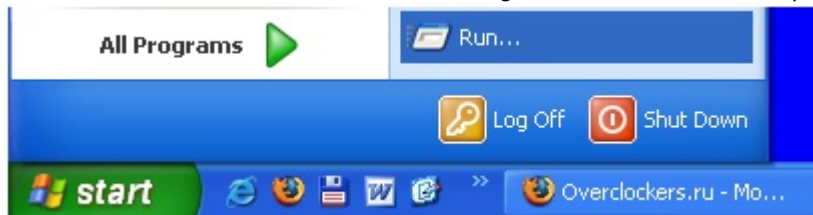

Now type the **cmd** command in the **Open** field of the **Run** dialog box and click the **OK** button to approve the entry.

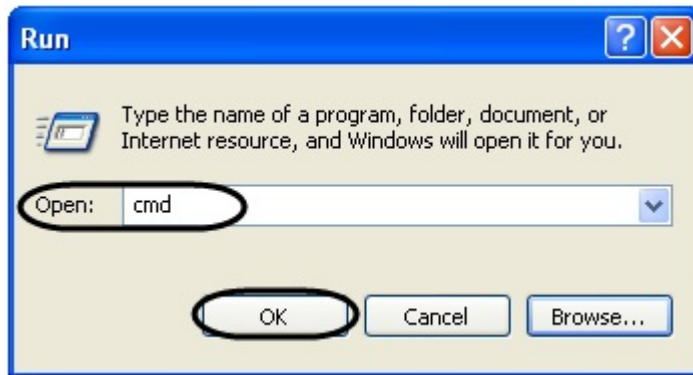

As a result the command line is displayed on the screen.

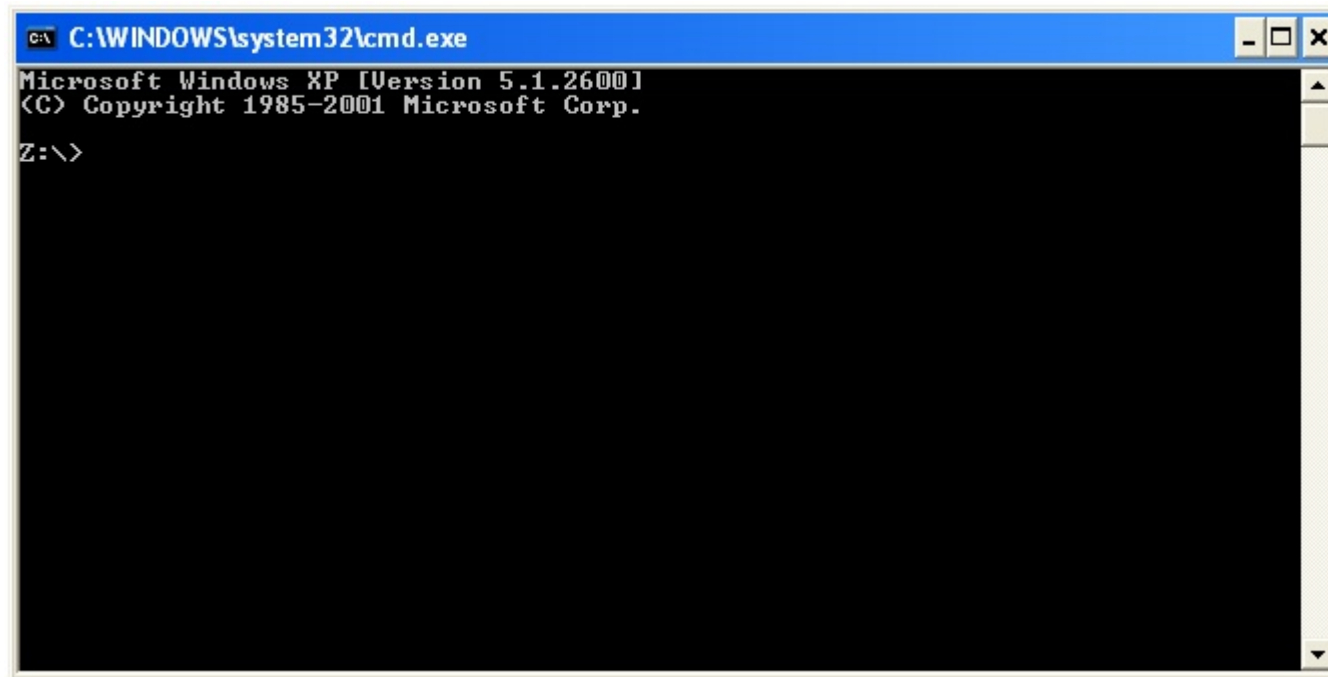

To check the selected IP address type the **ping 192.168.0.90** command in the command line. If the given IP address does not belong to any other device, then there is the **Request timed out** message on the screen.

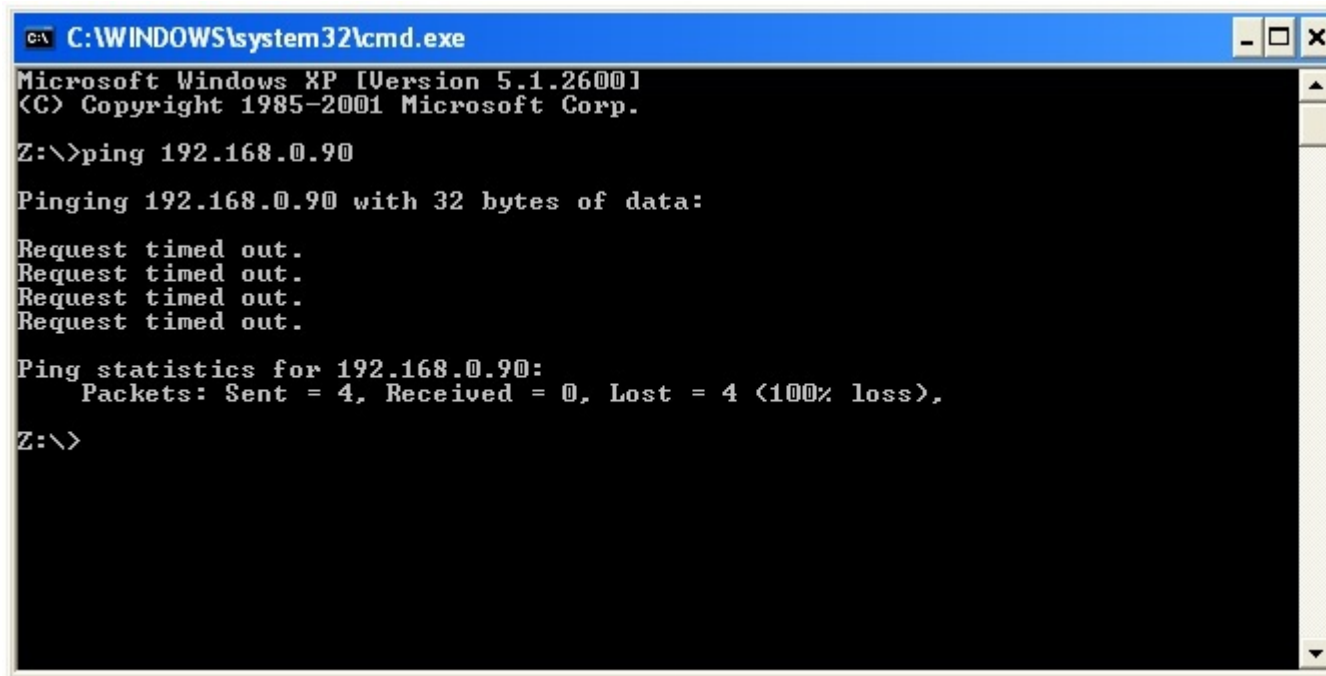

```
C:\WINDOWS\system32\cmd.exe
Microsoft Windows XP [Version 5.1.2600]
(C) Copyright 1985-2001 Microsoft Corp.

Z:\>ping 192.168.0.90

Pinging 192.168.0.90 with 32 bytes of data:

Request timed out.
Request timed out.
Request timed out.
Request timed out.

Ping statistics for 192.168.0.90:
    Packets: Sent = 4, Received = 0, Lost = 4 (100% loss),

Z:\>
```

2. Assign the required IP address to the Axis camera. Assign the selected IP address as follows:
 - a. Start the **IPUtility.exe** utility.
 - b. Start searching for all Axis IP cameras (see [Searching for IP devices](#) section).
 - c. Highlight the line containing the required IP camera in the list of Axis IP cameras connected to the local network.
 - d. Select the **Set IP Address** item in the **Server** dropdown list in the main menu of the **IPUtility.exe** utility.

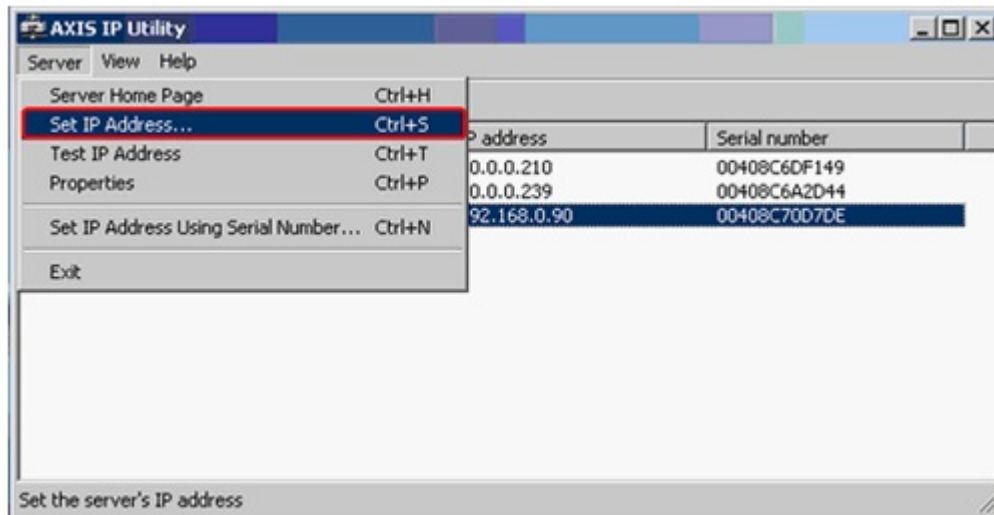

e. Type the required IP address on the **Set IP Address** panel.

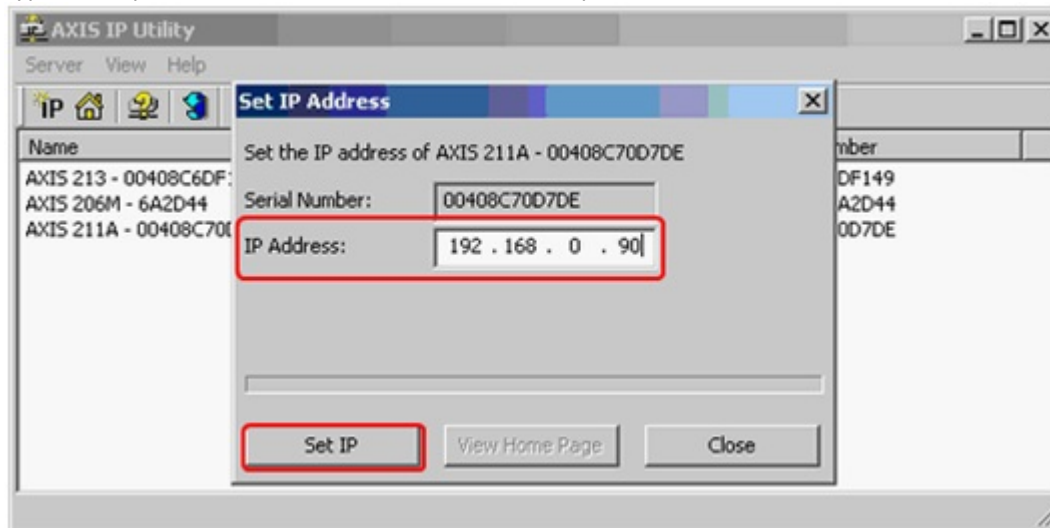

f. Confirm the IP address assigned to the Axis network camera by clicking the **Set IP** button.

As soon as the above operations are done, IP address settings of the network device are enabled.

Note
To prevent possible failures of the camera, check the assigned IP address again.

3. Check the IP address assigned to the Axis network camera.

Note

The IP address is checked with the use of the command line (see the 1st item of this instruction). If the IP address is set correctly, then following message is displayed in the command line window in reply to the **ping 192.168.0.90** command:

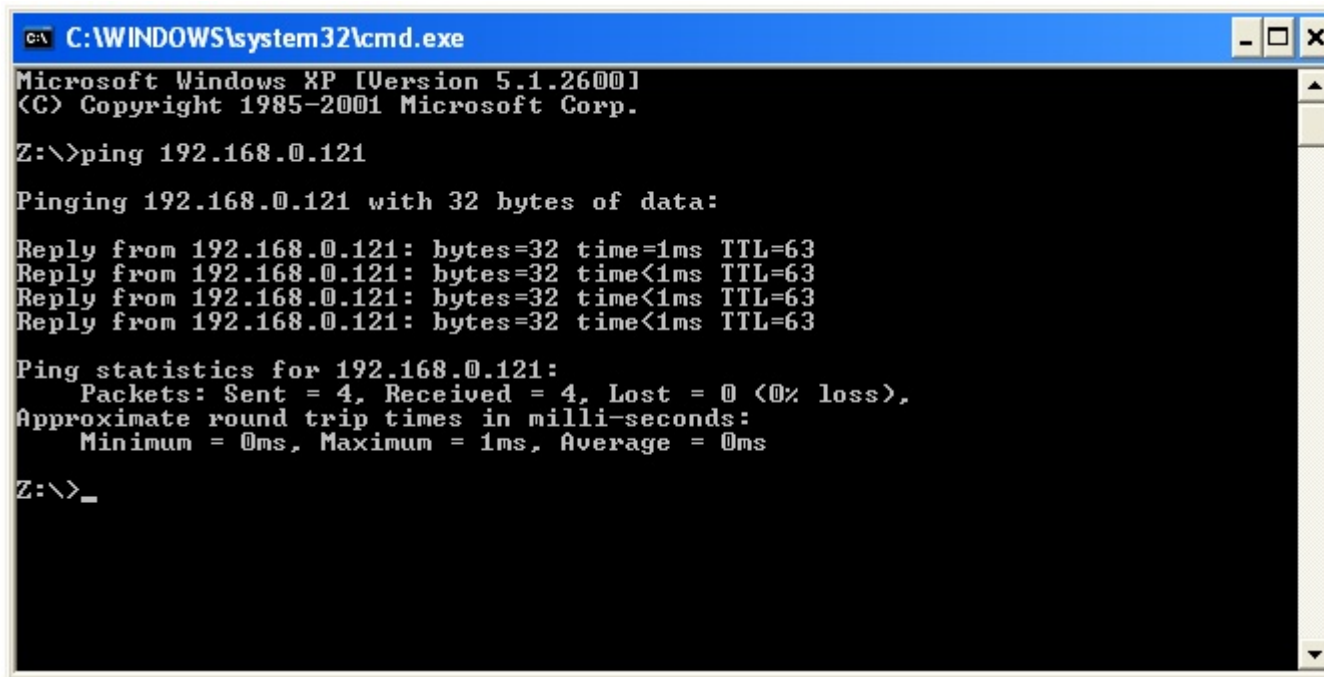

```
C:\WINDOWS\system32\cmd.exe
Microsoft Windows XP [Version 5.1.2600]
(C) Copyright 1985-2001 Microsoft Corp.

Z:\>ping 192.168.0.121

Pinging 192.168.0.121 with 32 bytes of data:

Reply from 192.168.0.121: bytes=32 time=1ms TTL=63
Reply from 192.168.0.121: bytes=32 time<1ms TTL=63
Reply from 192.168.0.121: bytes=32 time<1ms TTL=63
Reply from 192.168.0.121: bytes=32 time<1ms TTL=63

Ping statistics for 192.168.0.121:
    Packets: Sent = 4, Received = 4, Lost = 0 (0% loss),
    Approximate round trip times in milli-seconds:
        Minimum = 0ms, Maximum = 1ms, Average = 0ms

Z:\>_
```

The IP address is now assigned to the Axis camera. If assignment of the IP-address to the Axis camera is successful, then proceed to the network configuration of the device using the embedded Web Server.

How to call the Web Server home page of IP device

The home page of a network device is automatically created on the Web Server of the network device as soon as the IP address is assigned to the device using the IPUtility.exe utility (see [Assigning network addresses to IP devices](#) section).

Webpage of IP device can be downloaded in two ways:

1. Specify address manually. For this:
 - a. Start Internet Explorer.
 - b. Type the address in the **Address** line: `http://assigned IP-address` (for instance, `http://192.168.0.90`) and click the **Enter** key.

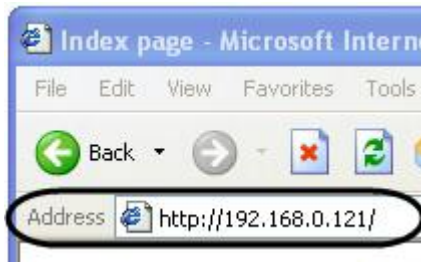

c. Type a user name and password to access the home page of the network device. The data specified in the **User name** and **Password** fields can be found in the documentation to the add-on network device.

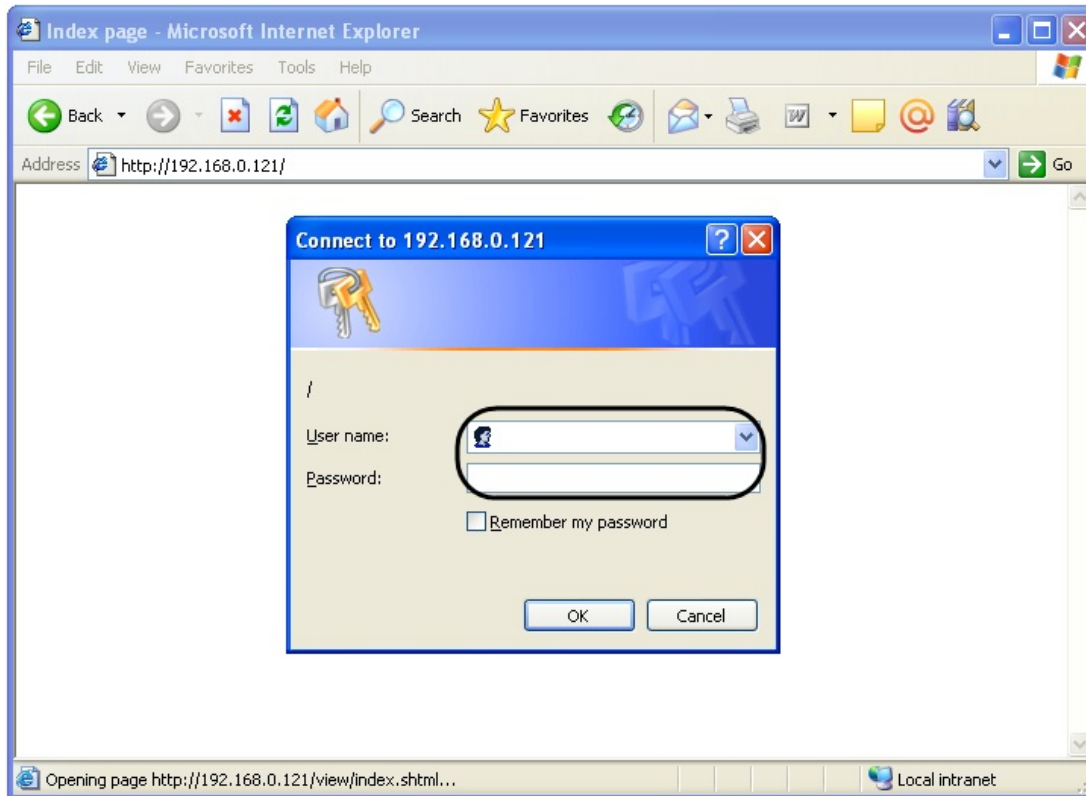

d. Click the **OK** button after specifying the user name and password.
2. On the settings panel of the **Camera** object corresponding to the IP device. Holding Shift click the **Video** button on the settings panel of the object.

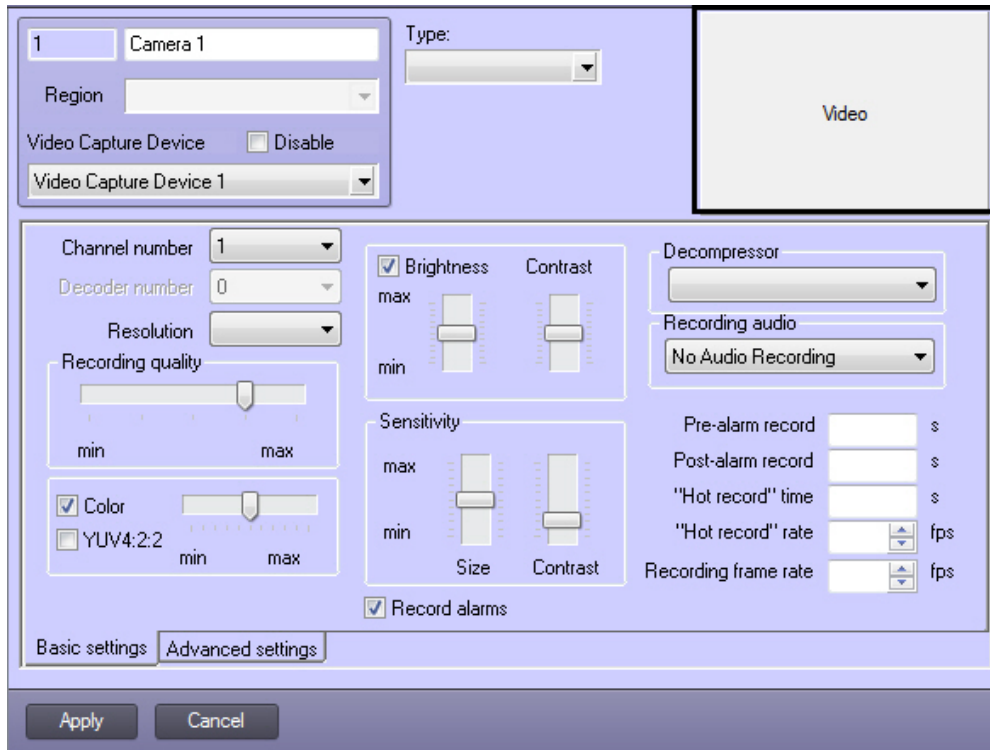

A webpage of *Web server* of IP device appears in the default browser.

If Drivers Pack cannot provide connection string to *Web server* of IP device, then Web server is attempted to be accessed at <http://login:password@camera-ip/>.



Note.

This feature is not available if Internet Explorer is the default browser.
The feature is supported by Axis and Bosch cameras.

The screen displays the viewing tile of the IP camera if a network camera is in use or one of the analog cameras connected to the network Server, if the network Server is in use.

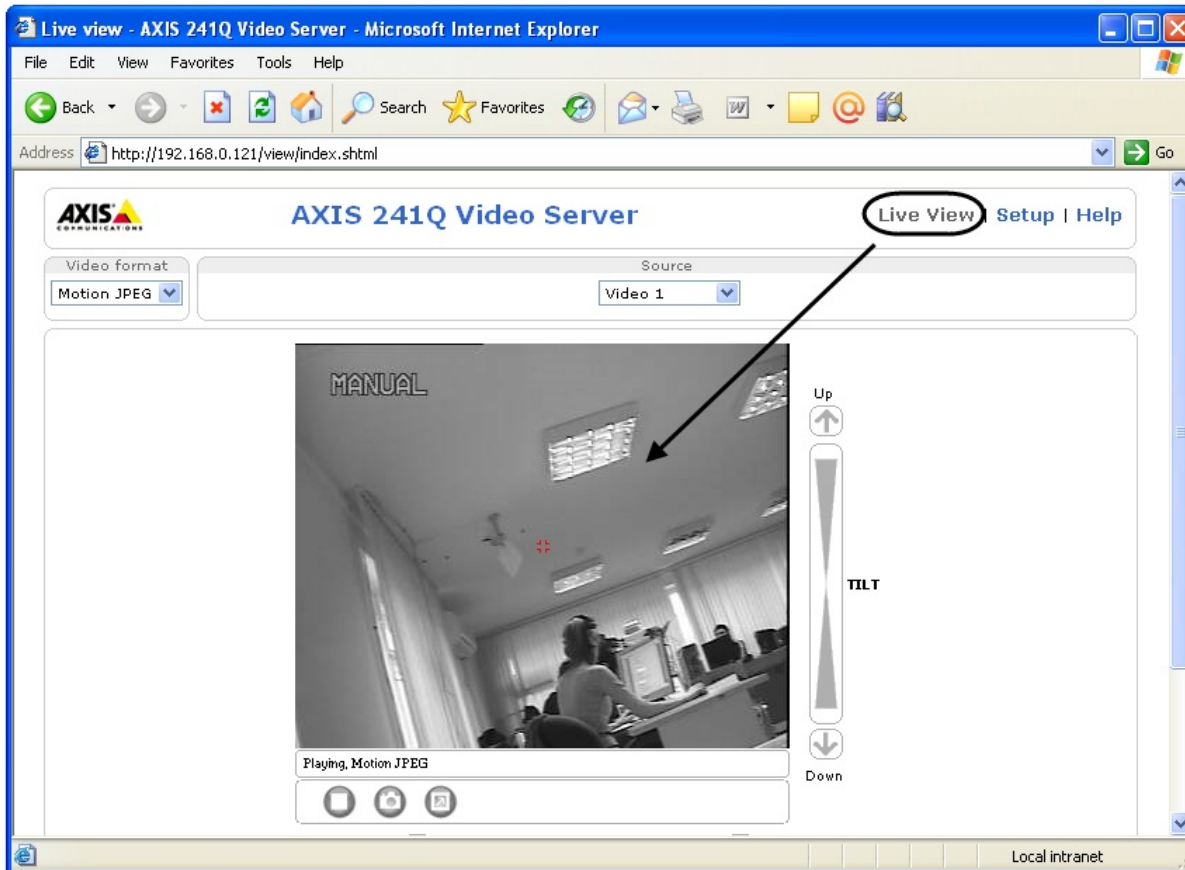

Note
If an IP camera gives no image, then check if the IP address is assigned correctly (see [Assigning network addresses to IP devices](#) section).

Configuring network parameters of IP-devices using the Web Server

Network parameters of the IP devices are configured using the interface of the embedded Web Server of the network device.

Note
Configuration of the network parameters of IP devices using the Web Server is a compulsory procedure.

To configure IP devices when working in the local network that is either equipped or non-equipped with the routers, do the following:

1. Start Internet Explorer.

2. Open the home page of the network device (see [How to call the Web Server home page of IP device section](#)).
3. Open the **Setup** section in the Web Server feature menu of the Web browser home page.



4. Select the **TCP/IP** tab in the **Setup** section.
Specify the **IP address**, **Subnet mask** and **Default router** in the given tab. To confirm the settings click the **Save** button.

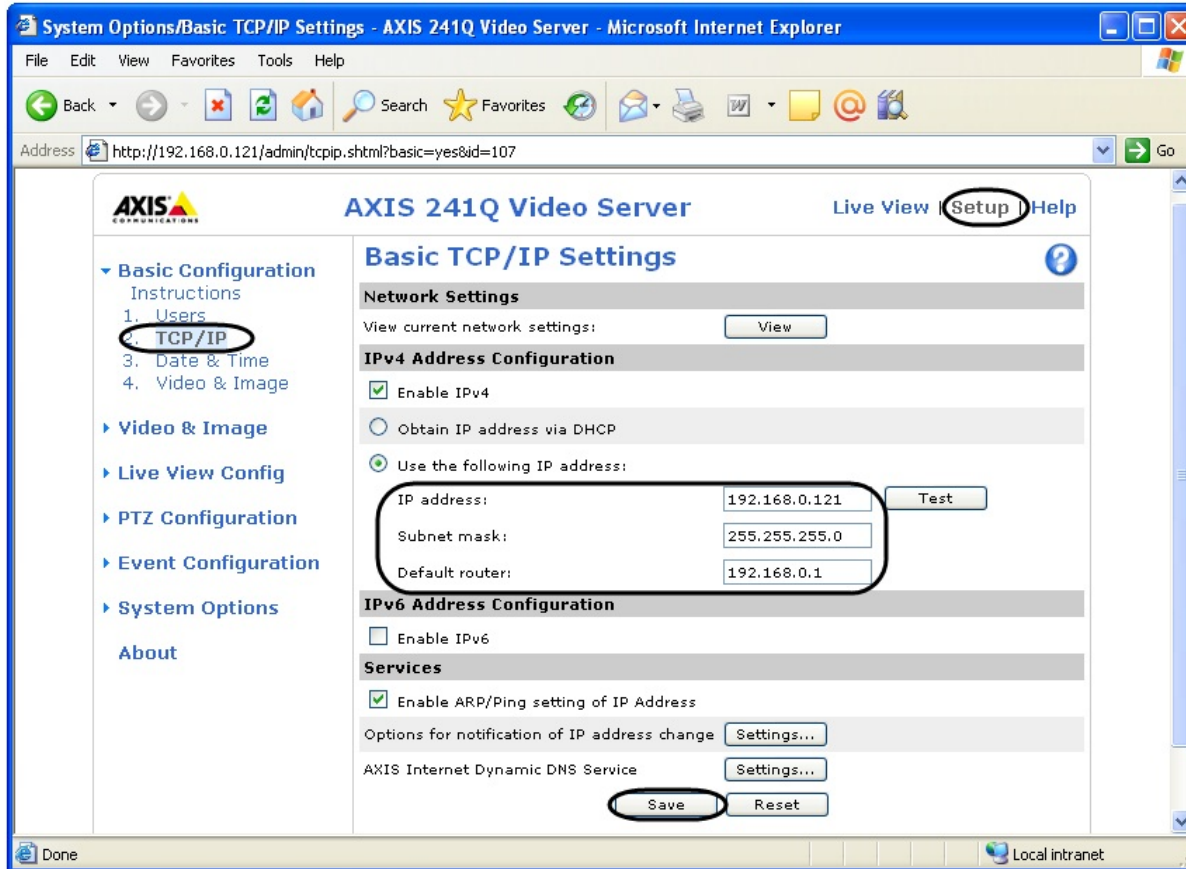

Specify the assigned IP-address of the network device in the **IP address** field (see [Assigning network addresses to IP devices section](#)).

In the **Subnet mask** field Specify the mask of the subnet to which the network device is connected.

When entering data in the **Default router** field, the following should be taken into consideration:

- a. If the Server and IP camera are in the same subnetwork, then the **Default router** parameter is not to be specified.

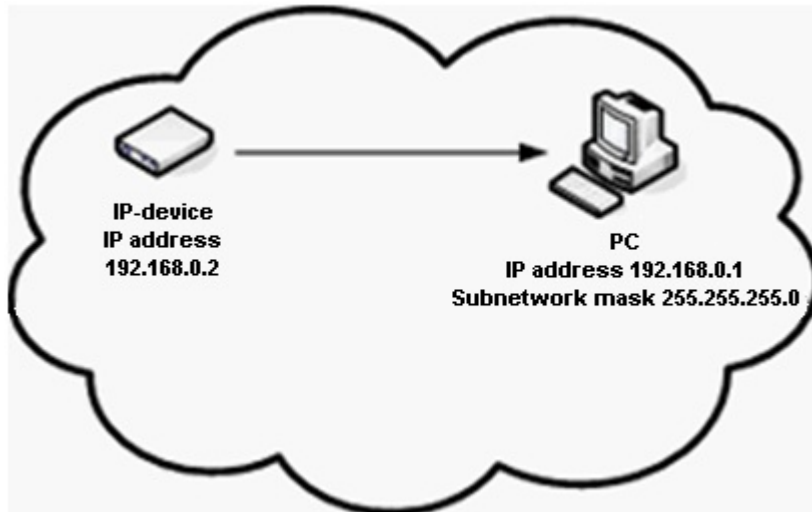

b. If the Server and IP camera are in different subnetworks, then the **Default router** parameter is to be specified.

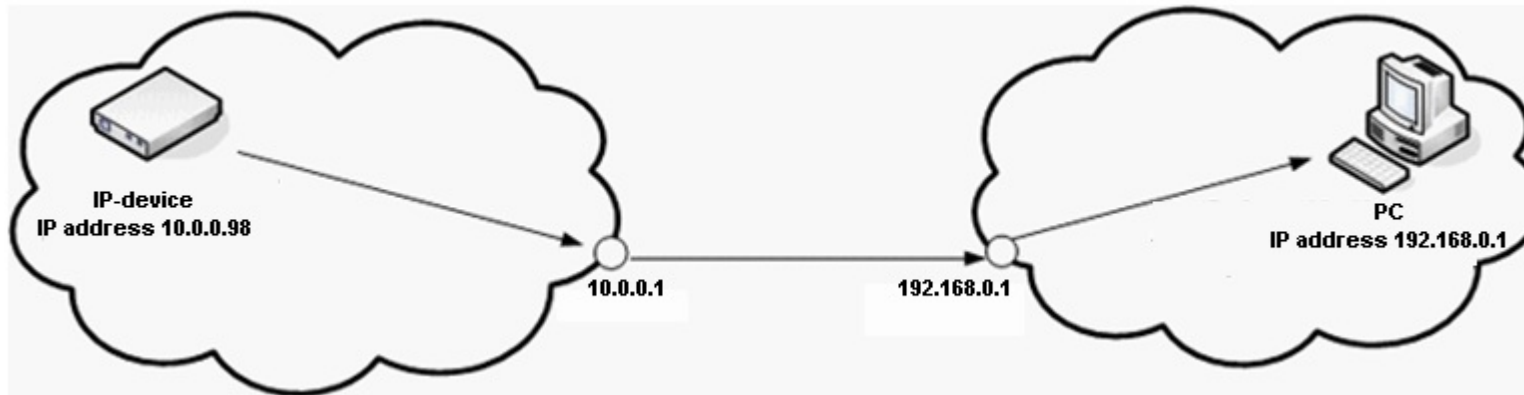

c. The IP address of the **Default router** is to match the subnetwork that the IP address of the camera belongs to.



Note

The camera does not operate if the IP address of the router is wrong or not specified at all.



5. Select **System Options / Ports & Devices / RS232** tab in the **Setup** section.
Select **Pan Tilt Zoom** in the **Port 1 Usage** field to show that the given interface is used for telemetry. To confirm the settings click the **Save** button.

Network parameters of the IP devices are now configured.

Now proceed to the configuration of IP devices in *INTELLECT™*.

Features of configuring Axis IP devices

It is strongly recommended to keep the default value of the **Friendly name** parameter unchanged for Axis IP device with enabled and supported *Bonjour* option. If there is an arbitrary value of the **Friendly name** parameter for Axis IP device, then search for a connected device in *INTELLECT™* will give incorrect results concerning this IP device.



Note

The **Friendly name** parameter is configured via the Web interface of IP device: **Setup -> System options -> Network -> Bonjour**

Note
The **Friendly name** parameter has the following default value: AXIS <model name> - <mac address>, where <model name> is model of Axis IP-device and <mac address> is its MAC address (for example, AXIS 214 - 00408C7D2610).

Features of configuring IP devices using the Web interface

On the page:

- Features of configuring Panasonic IP devices (i-Pro series) using the Web interface
- Features of configuring Samsung IP devices using the Web interface
- Features of configuring Mobotix IP devices using the Web interface
- Features of configuring Sony IP devices using the Web interface

Note
Details on how to configure IP devices using the Web interface are given in reference manuals to corresponding devices.

Features of configuring Panasonic IP devices (i-Pro series) using the Web interface

If a Panasonic IP device (i-Pro series) is configured to simultaneous transmission of video streams in MJPEG and MPEG-4 formats, then video stream rate in MJPEG format is limited by 5(10) fps.

Note
WV-NP1000\1004, WV-F284, WV-NP240\244, WV-NS202 and other models belong to IP devices of i-Pro series.

Features of configuring Samsung IP devices using the Web interface

An audio input gain for Samsung SNC-B2315 IP device is configured using **Setup Video & Audio Configuration Input Gain**. By default the **Input Gain** parameter equals 0 and audio signals are not played back by IP device. To play back audio signals select the value of the **Input Gain** parameter from 1 to 10 depending on the required audio input gain.

Samsung SNC-M300P IP device supports dual stream mode of video compression in MJPEG and MPEG-4 formats. If the value 25 fps is selected for the frame rate of MJPEG video stream (the **Frame Rate** parameter), then the range of values of analog parameter for MPEG-4 format is restricted by 3fps. To extend the given rate the value less than 25fps for the **Frame Rate** parameter of MJPEG-video stream is to be selected.

Features of configuring Mobotix IP devices using the Web interface

Resolution of Mobotix MX-Q22M-Sec-D11 panoramic camera is determined by selected mode of video displaying (**Display Mode**) in the **Setup Menu** tab.

Display Mode	Resolution
Full Image	2048*1536

Normal	1456*1088
Surround	1456*1088
Panorama	2048*768
Double Panorama	1456*1088
Focus Panorama	1456*1088

Note
In the **Double Panorama** mode the screen is divided by horizontal line into equal areas, each of which displays panoramic video.

As a Mobotix MX-Q22M-Sec-D11 camera is a panoramic one, proportions are distorted in INTELLECT™. The **Normal** mode is recommended to be set for proper video displaying.

Features of configuring Sony IP devices using the Web interface

The **Light Funnel** function is used for sensitivity enhancement of Sony SNC-CM120 IP device. The settings are accessed in **Setting -> Camera -> Sense up** tab.

Enabling the **Light Funnel** option leads to changing the range of values of the following settings in INTELLECT™:

1. Videostream rate;
2. Video resolution (in MJPEG format).

Configuring INTELLECT using the **Light Funnel** option:

Setting in INTELLECT™	Implementation of a setting in INTELLECT™	Range of values	
		The Light Funnel is disabled	The Light Funnel is enabled
Videostream rate	The Speed slider on the settings panel of the Video capture device object	Not more than 10fps	Up to 30 fps
Video resolution (in MJPEG format)	The Resolution dropdown list on the settings panel of the Camera object	Full (1280*960) High (960*720) Standard (640*480)	Standard (640*480)

Example
If Full resolution is set with enabled **Light Funnel** option, then video is displayed in standard resolution.

Appendix 3. Installing the Matrix Linux Server and LinuxHub

Introduction

Matrix is a custom hardware/software platform for building the integrated security systems based on digital surveillance systems.

Matrix Linux Server (LS) and Matrix LinuxHub (LH) are the hardware/software video commutators used for receiving, processing (analog-to-digital conversion) and transmitting video images via IP networks. LS and LH work under the Linux OS (kernel 2.6). A LH is shown in the figure.



There are two basic configurations of LS (LH):

1. Based on FS5 video capture card;
2. Based on FS6 or FS16 video capture cards;
3. Based on FX4 video capture card;
4. Based on FX8 video capture card;
5. Based on FX16 video capture card.

The main technical specifications of LS (LH) depend on the specifications of video capture cards. LS (LH) is used with Intellect-based systems. Remote access to LS (LH) is available using the Web interface.

LH/LS features:

1. Enclosed in desktop casing of microATX type (FS6 card) and Mini-ITX type (FS5 card) or 1u type that can be fixed or installed in the computer cabinet (FX4, FX8 and FX16 cards).
2. Watchdog hardware system for system failure prevention.
3. Flash memory used for storing the operating system.
4. Telemetry devices connection.
5. External storage connection for storing video recordings from video cameras (LS only).
6. External devices connection to the embedded sensor/relay module – 4/4 for FS5, FX4, FX8 and FX16 and 4/16 for FS6/16 (optionally).
7. Possibility for remote firmware update.
8. No local videostream display (monitor connected directly to LS (LH) for viewing the video received from the cameras).

The figure below shows a general structural diagram of the digital video surveillance system based on the Matrix hardware/software platform.

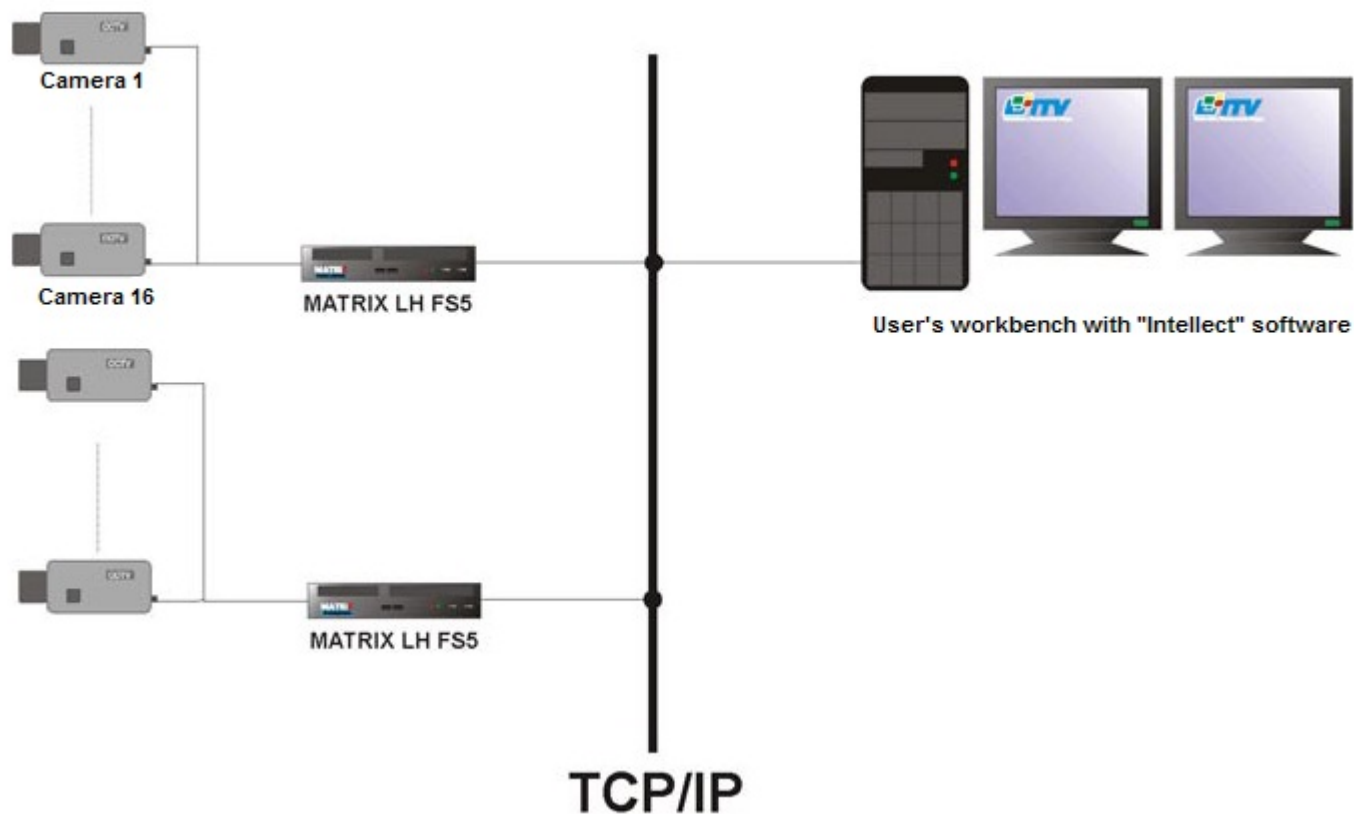

LH is not an independent device. In contrast to the LS it receives the system configuration from *Intellect* instead of saving it. LH can operate correctly and display video through the Web interface only if it is connected to the core of *Intellect*.

Installing Linux Server (LinuxHub)

LS/LH are installed and configured as follows:

1. [Connecting and running Linux Server \(LinuxHub\)](#). This stage is common for LS and LH.
2. [Network identification of Linux Server \(LinuxHub\)](#). This stage is common for LS and LH.
3. Configuring LS (LH) for INTELLECT™ operation. This stage is different for LS and LH.

Connecting and running Linux Server (LinuxHub)

This stage includes the following:

1. Connect LS (LH) to the local network: plug the network cable into the network socket and the corresponding LAN socket on the LS (LH).
2. Connect LS (LH) to the power supply, plug the power cable into the 220 V mains and the corresponding power plug on the back panel of LS (LH).

3. Turn LS (LH) on, press the power button on the front panel of LS (LH).
4. Wait for LS (LH) system to load. It usually takes no more than one minute.

Note
When you run LS after incorrect shutdown, there is a check of hard disks for errors that can take much time (depends on archive size).

Network identification of Linux Server (LinuxHub)

This stage includes the following:

1. Run the **HubSearch** utility bundled with *INTELLECT™* software kit. To run the utility in the Windows main menu click **Start => All Programs => Intellect => Tools => HubSearch**.
2. Select the network adapter via which your computer is connected to the LAN to which LS (LH) is connected (the **Select NetAdapter** dropdown list) and click the **Search** button.

The screenshot shows the HubSearch utility window. The 'NetAdapter Info' section has a dropdown menu for 'Select NetAdapter' set to 'Realtek RTL8168/8111 PCI-E'. The IP address is 192.168.247.1, the Mask is 255.255.255.0, and the MAC is 00:1B:FC:88:86:E1. The 'VideoHub Addresses' section is empty, displaying 'No VideoHub Devices'. The 'VideoHub Properties' section has two radio buttons: 'Use DHCP' (selected) and 'Use the following IP address'. Below these are fields for 'IP address', 'Subnet mask', and 'Default gateway', each with a small grid of dots. An 'Apply' button is next to these fields. The 'Net BIOS Name' section has an empty text box and an 'Apply' button. At the bottom, the 'Search status' field shows 'No search', and there are 'Search' and 'Close' buttons.

3. The system will search for all LSs and LHs connected to this local network. The **Search status** field will display **Search. Please, wait** during the search process.

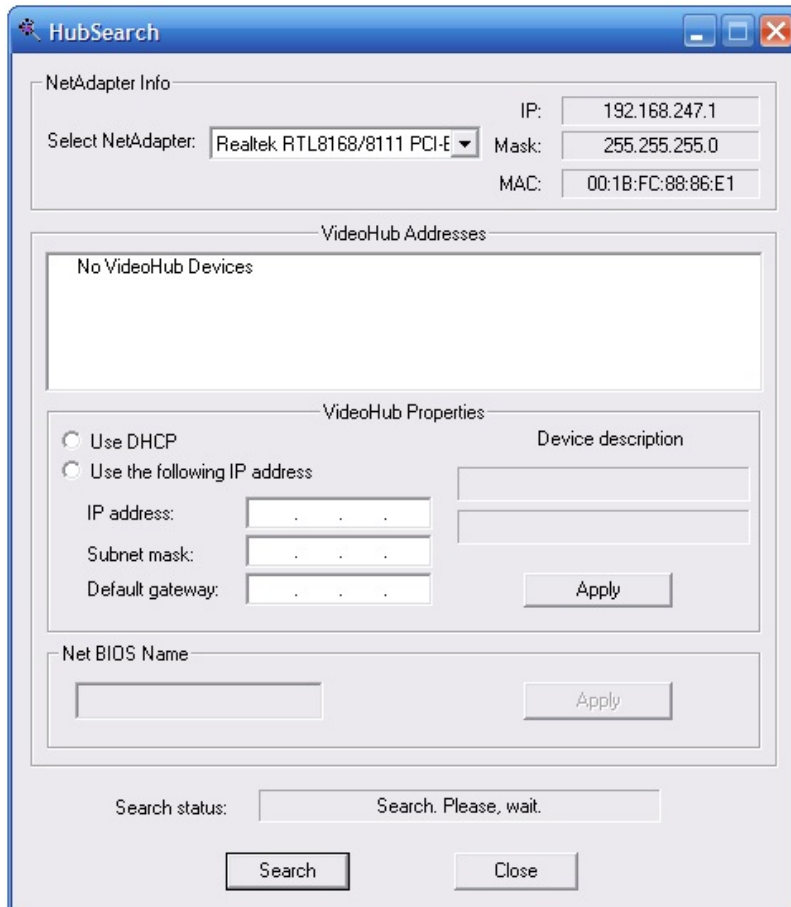

4. When the search is completed, the **Search status** field will display **Stop search. Find...** . The found devices will be added to the **VideoHub Addresses** list. Select the required LS (LH) in the list. The **VideoHub Properties** field will display the information on the selected device.

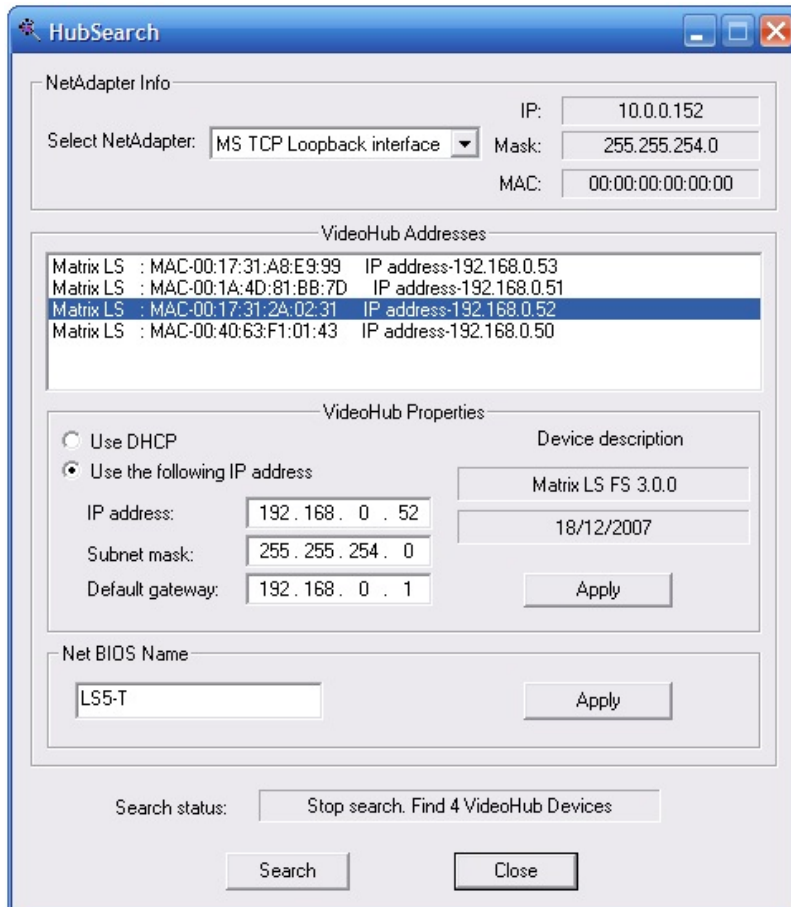

5. Some of the parameters of the selected device can be edited (IP address, subnet mask, default gateway and NET BIOS name). To edit the NETBIOS name, change the value in the **Net BIOS Name** field and click the **Apply** button next to this field. To specify the IP address, subnet mask and default gateway manually, set the **Use the Following IP address** checkbox checked, specify the values in the fields and click the **Apply** next to these fields. The default values are set by the **Dynamic Host Configuration Protocol** service when the DHCP checkbox is set.
6. Test LS (LH) connection, ping the specified IP address using the **Ping** utility bundled with Windows.

```
C:\WINDOWS\system32\cmd.exe
Microsoft Windows XP [Version 5.1.2600]
(C) Copyright 1985-2001 Microsoft Corp.

C:\Documents and Settings\user>ping 192.168.254.1

Pinging 192.168.254.1 with 32 bytes of data:

Reply from 192.168.254.1: bytes=32 time=10ms TTL=128
Reply from 192.168.254.1: bytes=32 time<1ms TTL=128
Reply from 192.168.254.1: bytes=32 time<1ms TTL=128
Reply from 192.168.254.1: bytes=32 time<1ms TTL=128

Ping statistics for 192.168.254.1:
    Packets: Sent = 4, Received = 4, Lost = 0 (0% loss),
    Approximate round trip times in milli-seconds:
        Minimum = 0ms, Maximum = 10ms, Average = 2ms

C:\Documents and Settings\user>_
```

Configuring Linux Server for INTELLECT™ operation

This stage includes the following:

1. Run *INTELLECT™*. To run the system in the Windows mainmenu click **Start All Programs Intellect Intellect**.
2. Create a new **Computer** object in the **Hardware** tab and specify the NetBIOS name (see Network identification of Linux Server (LinuxHub) section) into the **Computer name** field.

Computer name
LS44

Name
VideoServer LS44

Apply Cancel

- Specify the IP addresses of your computer and LS in the **Architecture** tab then restart *INTELLECT™*.

Specifying a LS IP address:

Architecture		Hardware	Interfaces	Users	Programming
Computer	Name	Connection	With computer	IP address	Send events
LS44	VideoServer LS44	<input checked="" type="checkbox"/>	S-UYUTOVA	198.168.0.53	<input checked="" type="checkbox"/>
S-UYUTOVA	Computer				

Specifying a computer IP address:

Architecture		Hardware	Interfaces	Users	Programming
Computer	Name	Connection	With computer	IP address	Send events
LS44	VideoServer LS44	<input checked="" type="checkbox"/>	LS44	192.168.0.55	<input checked="" type="checkbox"/>
S-UYUTOVA	Computer				

- In the **Hardware** tab click **Reconnect** in the contextual menu of the created computer object. If the settings are correct, the created computer is displayed in the hardware list.



Set other settings in *INTELLECT™*. For example, to display video received from a camera connected to LS, create a **Video Capture Device** object under the **Computer <NetBIOS name>** object in the tree, set the object type in accordance with the type of video capture card on which LS is created. Create the **Camera** object under the **Video Capture Device** object and set all required settings for the created video camera.

Creating a **Camera** object:

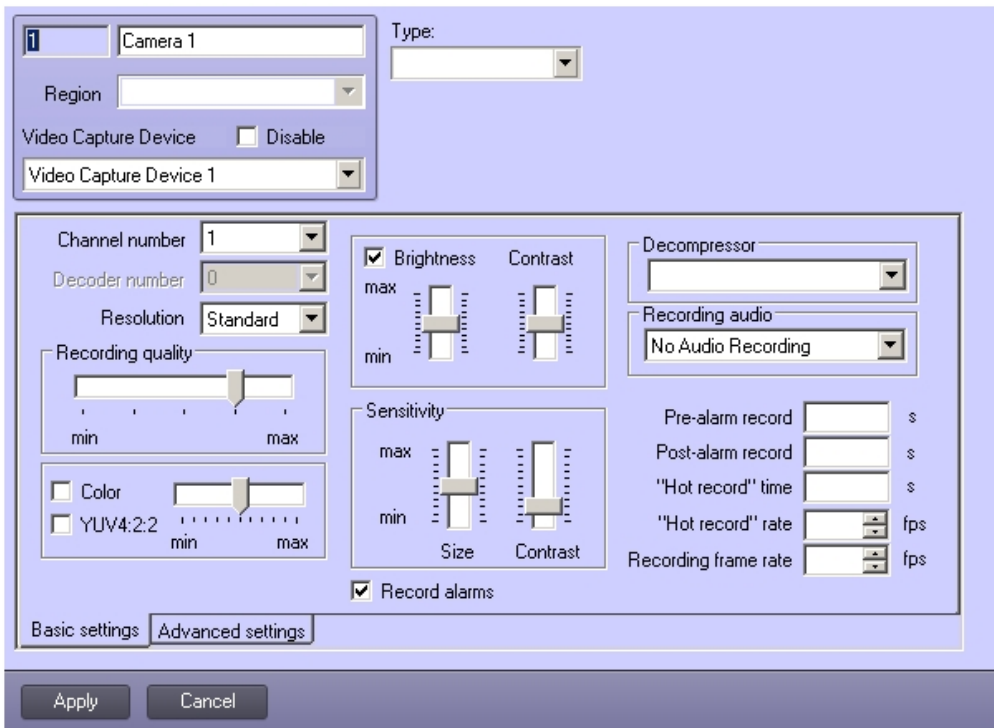

Example of LS configuration:

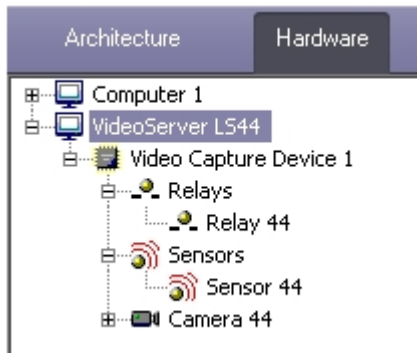

Note
 Details on how to configure *INTELLECT™* are given in [Configuring security system components in INTELLECT™ software](#) section. Some LS settings can be set in the Web interface (see [Web interface of Linux Server \(LinuxHub\)](#) section).

The **Relay** and **Sensor** objects are created under the **Video Capture Device** object with the first PCI channel used by the card. For example, when building security video subsystem with the use of two SC300Q16 (FX4) video capture cards and two Sensor-Relay cards (low profile), the **Relay** and **Sensor** objects are to be created under the **Video Capture Device** object with **00** (1st SC300Q16 (FX4) video capture card) and **04** (2nd SC300Q16 (FX4) video capture card) values of the PCI channel.

Configuring the **Audio card** object take into account that the list of available digitization rate can not agree with the one stated in the specification. This list depends on ALSA driver for LS.

Configuring LinuxHub for INTELLECT™ operation

This stage includes the following:

1. Run *INTELLECT™*. To run the system in the Windows mainmenu click **Start All Programs Intellect Intellect**.
2. In the **Hardware** tab create a new **Video Capture Device** under the **Computer** object, specify the **LinuxHub** type and the IP address of the required LH (see [Network identification of Linux Server \(LinuxHub\)](#) section).

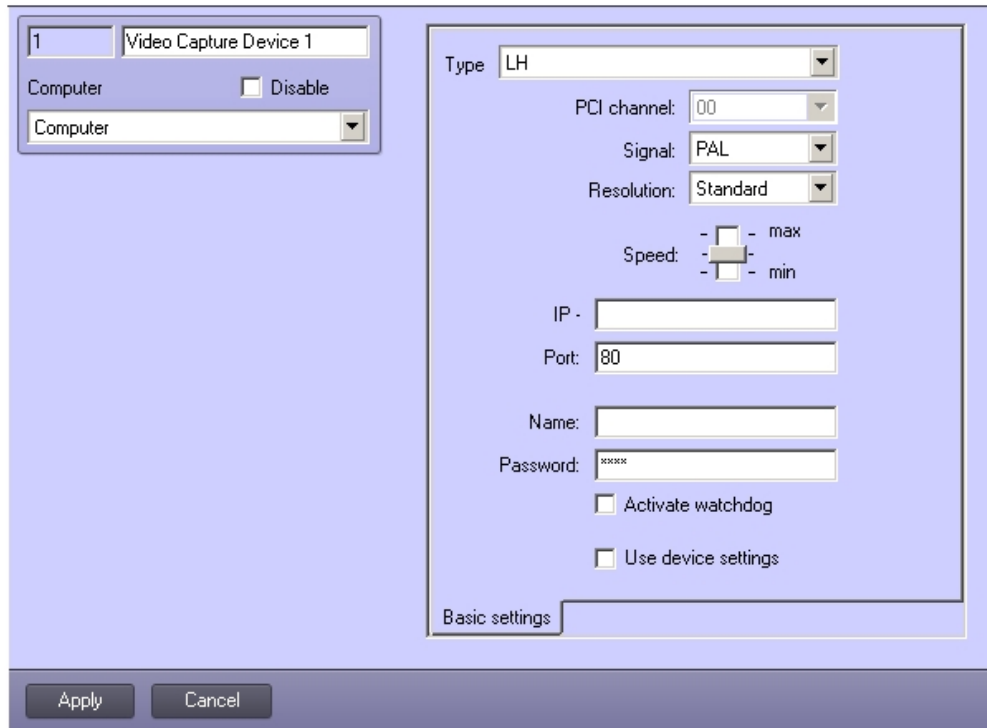

3. Set other settings in *INTELLECT™*. For example, to display video received from a camera connected to LH, create a **Camera** object under the **Video Capture Device <card id>** object in the object tree and configure the created camera.
Creating a **Camera** object:

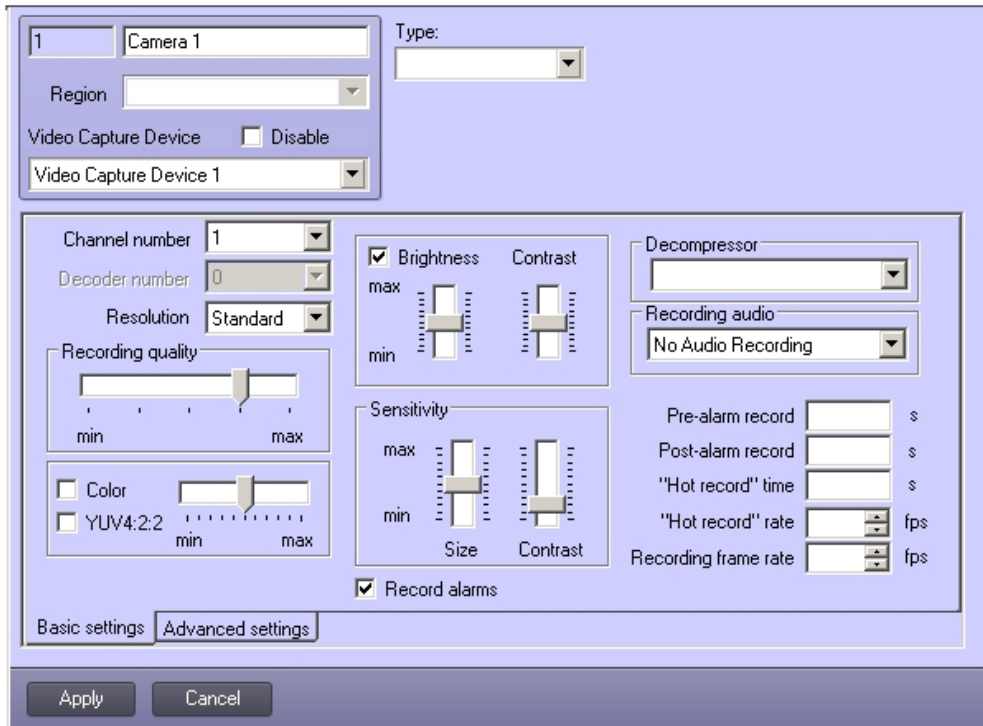

Example of LH configuration:



4. Restart *INTELLECT*[™].

Note Details on *how to configure INTELLECT*[™] are given in [Administrator's Guide](#). Some LH settings can be set in the Web interface (see [Web interface of Linux Server \(LinuxHub\)](#) section).

LH enables working with audio received both from the cards and from the embedded audio card. Configure LH audio subsystem as follows:

1. Create an **Audio card** object under the **Computer** object in the **Hardware** tab, set the **LH** type of the video capture card (**1**).

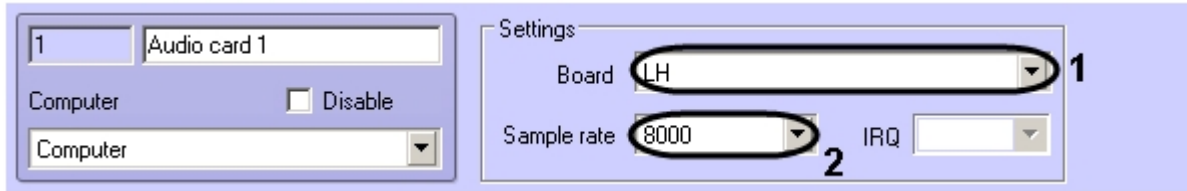

2. Set the sample rate for audio signal processed on LH (2).
3. Create and configure the required number of **Microphone** objects under the **Audio card** object.
4. Restart *INTELLECT™* and LH.



Note

To enable recording audio stream from the microphone, set the environment variable before starting VideoServerCore:
 export WRITE_AUDIO_INPUT= audio_device_number.

Number of the audio device can be found in VideoServerCore logs:
 CBoard(audio_device_number, HDA Intel PCH:VT1708S Analog (hw:0,0)).

LH for INTELLECT™ operation is now configured.

Setting up frame resolution

There are three options of frame resolution in INTELLECT™ software: **Standard**, **High** and **Full**.

The actual resolution of the digital video signal depends on the input analog video signal format. A table for the settings and actual resolution in different formats is given below.

Resolution	PAL	NTSC
Standard	352 x 288 pixels	352 x 240 pixels
High	704 x 288 pixels	640 x 240 pixels
Full	704 x 576 pixels	640 x 480 pixels

Resolution of digital video signal is set for each camera individually.

Standard resolution is a default one for video signal digitization on all cameras.

To change the selected camera resolution, do the following:

1. Go to the **Hardware** tab in the **System settings** dialog box (1).
2. In the objects tree of the **Hardware** tab, select the **Video Capture Device** object, created before (2). The settings panel for the selected object is displayed on the right of the **Hardware** tab.

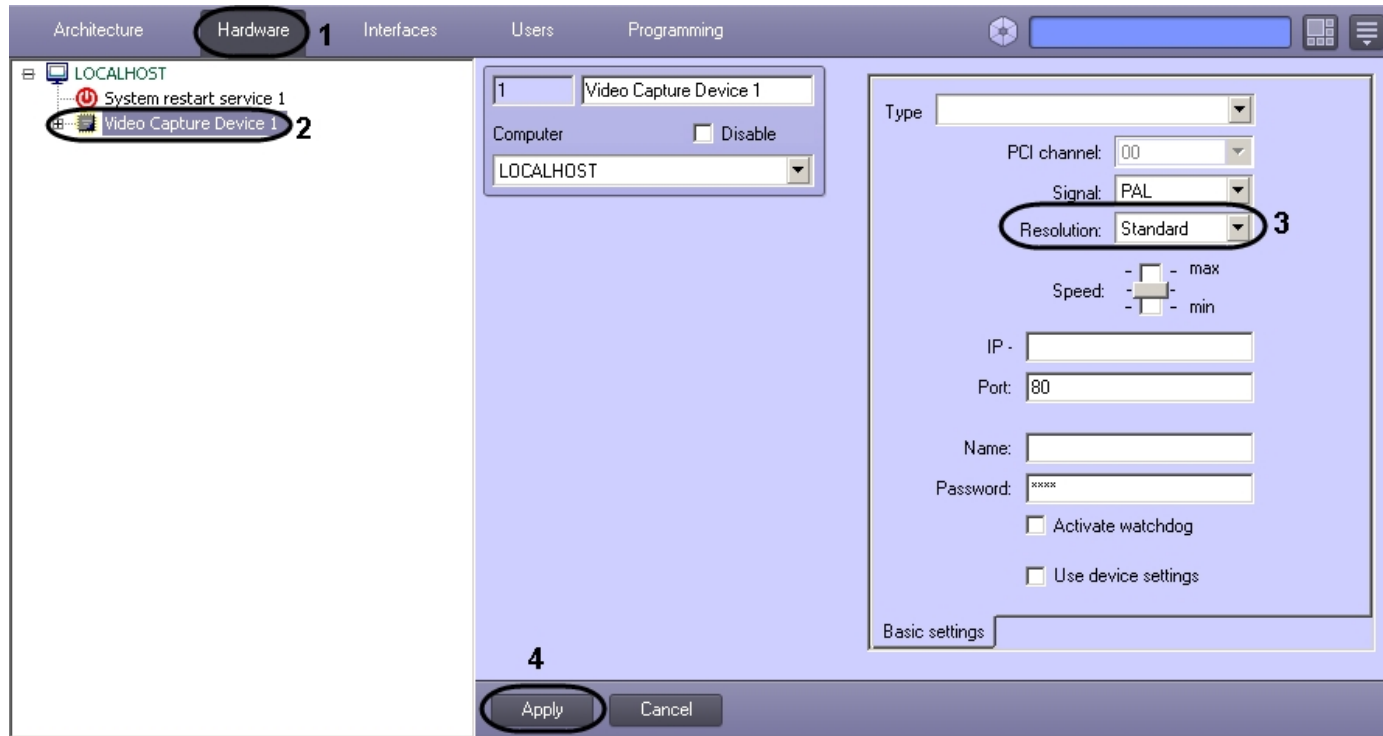

3. In the **Resolution** drop-down list, select the desired resolution (3).
4. Click the **Apply** button (4).

Video signal resolution is now set.

Note.
Changing video signal resolution, take account of:

1. In the multiplex mode (when the ADC of a video capture card digitizes signals from several cameras), with the Full resolution setting for at least one camera, the total frame rate of video signal digitized by this ADC will decrease by 1.3 times.
2. Resolution increasing leads to an increase of the frame size and, consequently, builds up the video stream, recorded onto the hard drive and transmitted in the network.

Web interface of Linux Server (LinuxHub)

The Web interface is designed for remote access to LS (LH) and has the following features:

1. Viewing video received from the cameras connected to LS (LH);
2. Monitoring the state of relays and sensors connected to LS (LH);
3. Monitoring LS (LH) operability;
4. Configuring LS (LH) network parameters;
5. Resetting LS (LH) configuration;

6. Updating LS (LH) firmware;
7. Downloading the license key to LS (LH).

Note.
Viewing video signal received from video cameras connected to LH is impossible in case of LH is not connected to the *Intellect* core.

Access to Web interface

To access LS (LH) Web interface, specify the IP address of the required LS (LH) in the address line of the browser. The Web interface home page will be displayed.

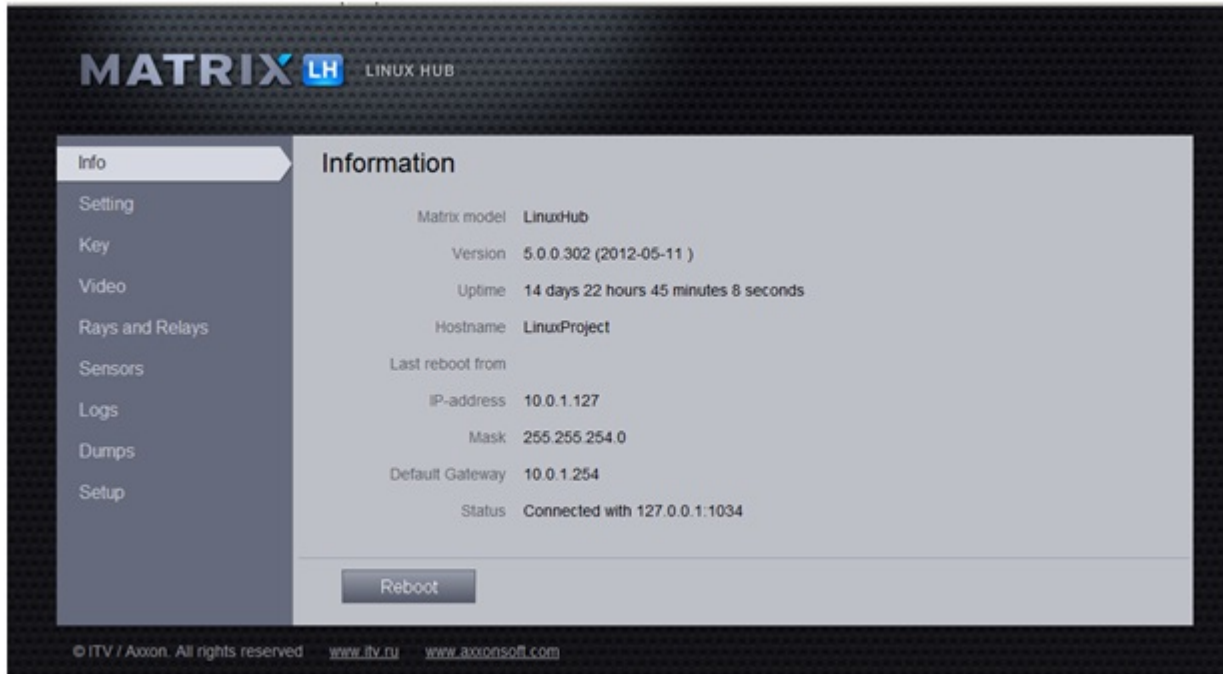

The following information is displayed in the **Info** tab:

1. The LS (LH) name;
2. The LS (LH) firmware version;
3. Running time since last LS (LH) reboot;
4. NetBIOS name of LS (LH);
5. IP address of the remote computer from which LS (LH) was last rebooted;
6. IP address, subnet mask and default gateway of LS (LH).
7. Status of LS (LH) connection to *INTELLECT*[™].

The **Reboot** button is located below used for LS (LH) reboot. The **The Matrix is restarting now** message is displayed during the reboot.



**Note**

The browser is to support Java to work correctly with the Web interface.

Viewing video

The **Video** tab allows viewing video signal received from LS (LH) cameras.

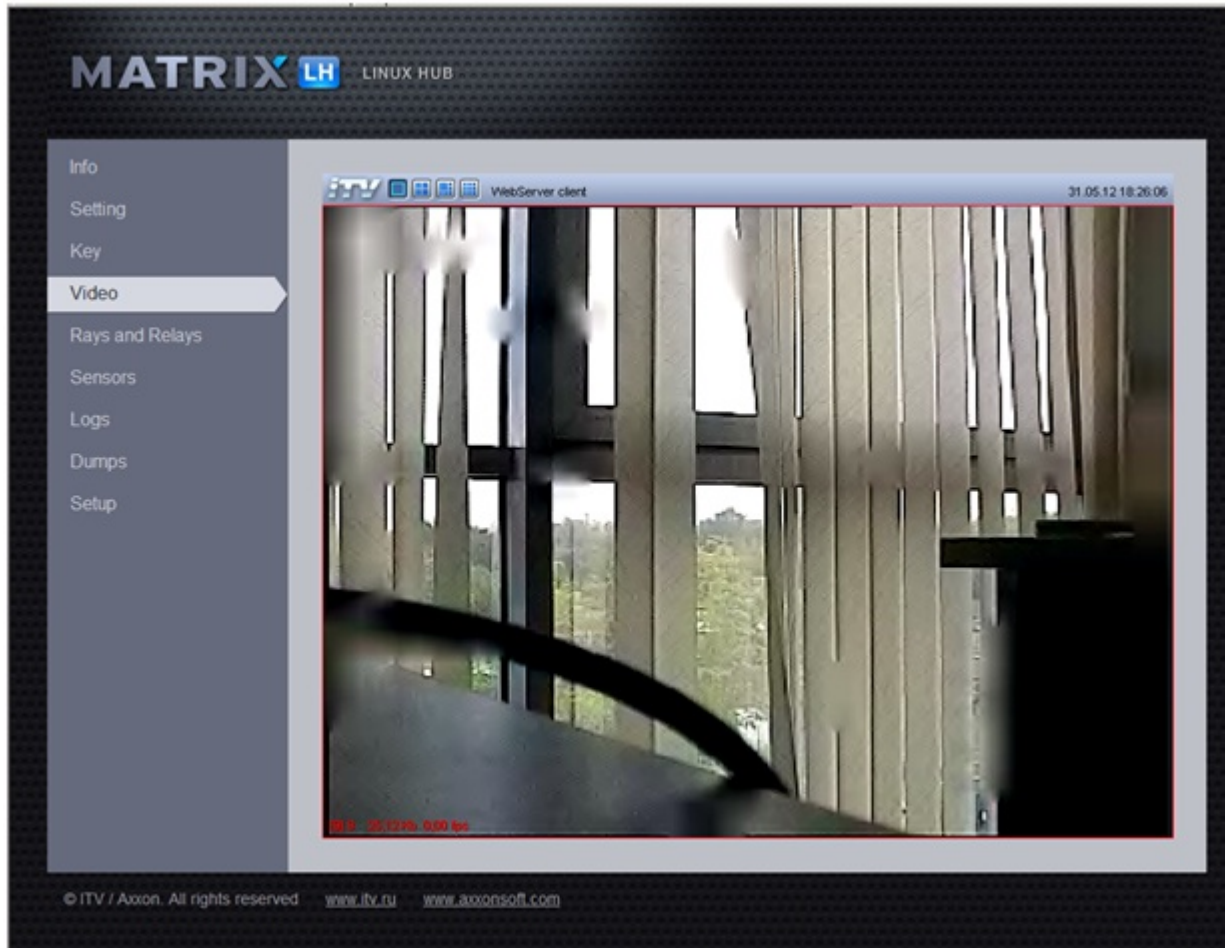

Viewing video received from LS (LH) cameras in the Web interface is the same as viewing video in the web browser (see [Operator's Guide](#)).

Monitoring state of rays and relays

State of connected rays and relays is monitored in the **Rays and Relays** tab.

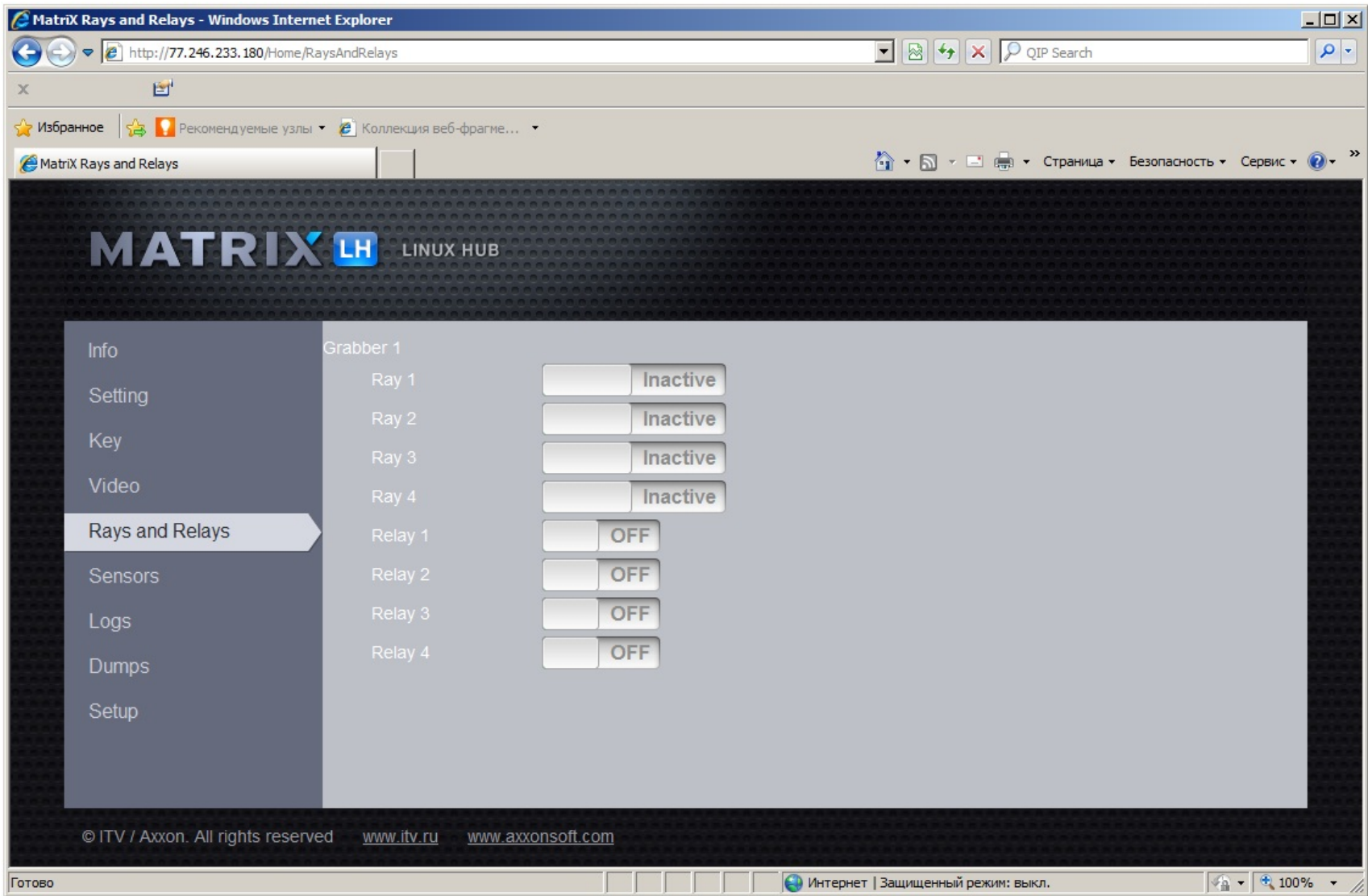

This tab displays the list of rays and relays connected to LS (LH) and their states.

Monitoring Linux Server (LinuxHub) operability

The **Sensors** tab allows monitoring operability of LS (LH).

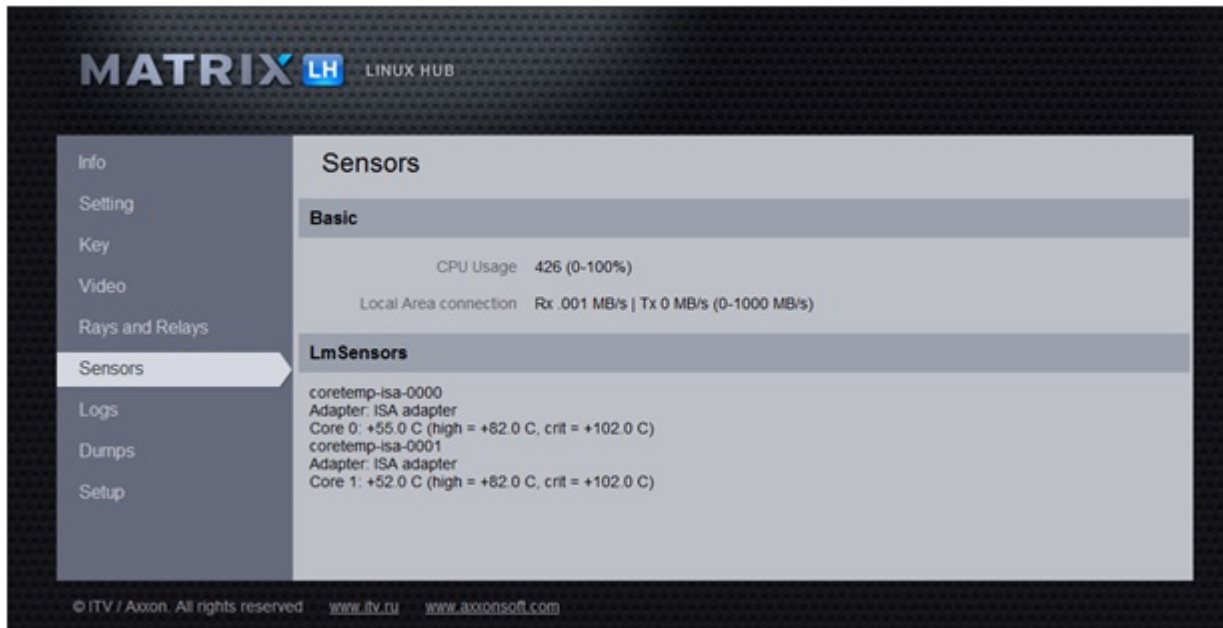

Sensors allow monitoring the state of computer hardware: CPU temperature, fan speed, memory usage, etc. The **LmSensors** library is used to obtain this information. Data received with its help are displayed in the **LmSensors** group. Some data can be obtained without this library; these data are displayed in the **Basic** group.

For basic sensors the name and current value are given, limit of accepted values is specified in parentheses.

Configuring Linux Server (LinuxHub) network parameters

The **Setting** tab allows configuring the network parameters of LS (LH):

1. The password for accessing LS (LH) Web interface (the **New password** and **Confirm** fields);
2. NetBIOS name of LS (LH);
3. IP address, subnet mask and default gateway of LS (LH).

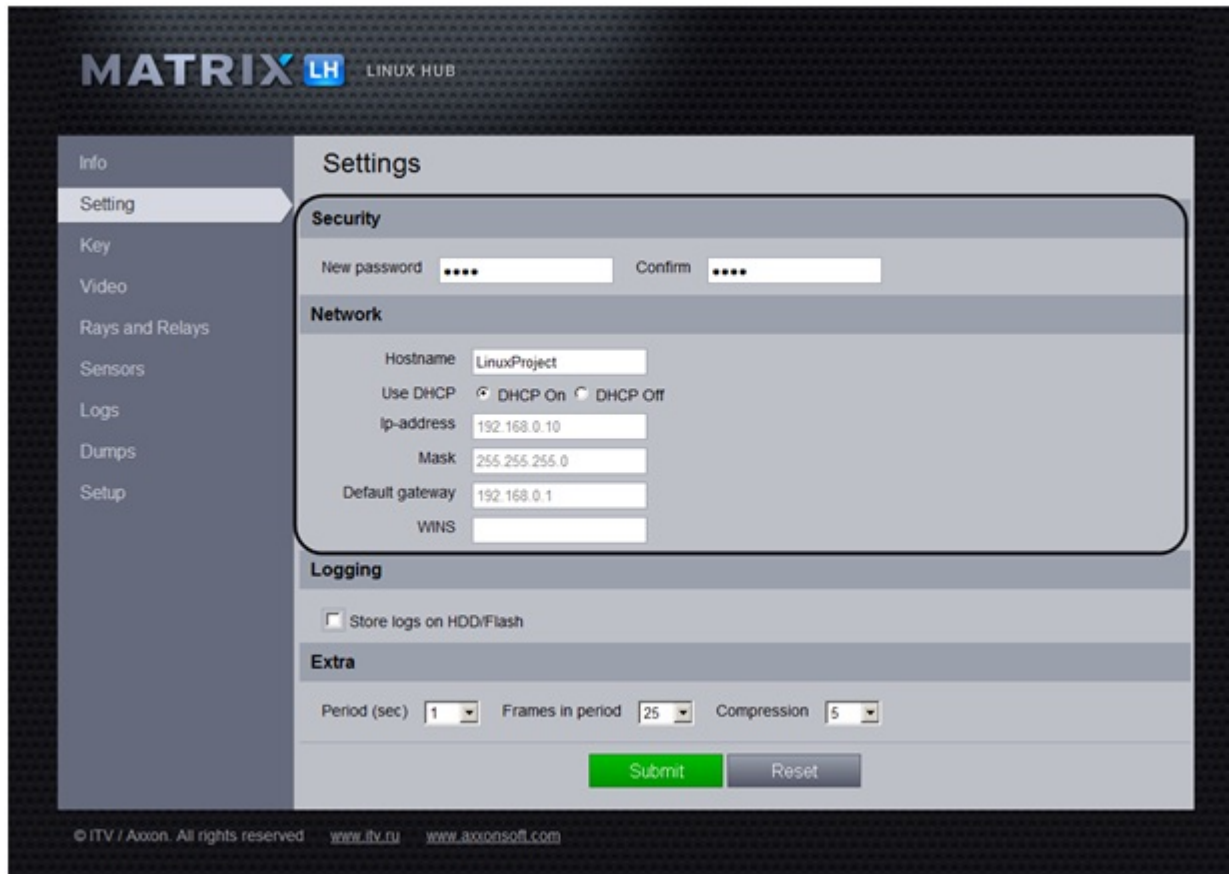

Note To specify an IP address, subnet mask, default gateway and address of WINS Server manually, set the **DHCP Off** checkbox checked and specify the values. To set the parameters automatically using the Dynamic Host Configuration Protocol service, set the **DHCP On** checkbox checked.

When all values are set, click the **Submit** button to save the changes or the **Reset** button to restore the previous values.

Configuring the Linux Server (LinuxHub) logging

To start storing logs on HDD or portable data medium set the **Store logs on HDD/Flash** checkbox checked.

After setting all necessary parameters click the **Submit** button to save all the changes or the **Reset** button to restore the previous parameters.

Configuring parameters of video stream displaying

Parameters of video stream displaying in LS (LH) Web interface are configured in the **Settings** tab of the **Extra** group:

1. Select the period (in seconds) in the **Period (sec)** dropdown list.
2. Select the number of frames that are to be displayed for the selected period in the **Frames in period** dropdown list.
3. Select the videostream compression rate in the **Compression** dropdown list.

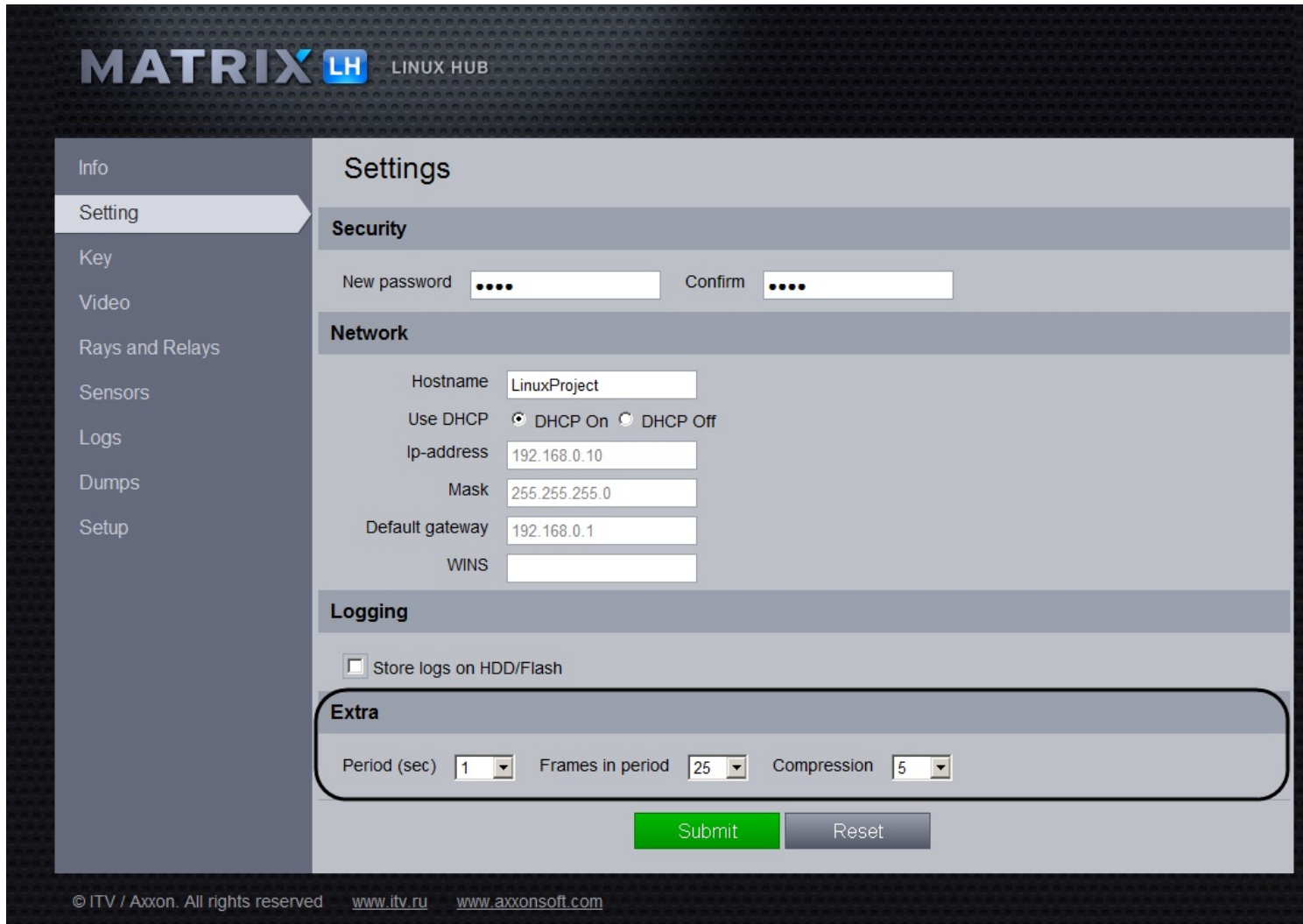

After setting all necessary parameters click the **Submit** button to save all the changes or the **Reset** button to restore the previous parameters.

Setting Linux Server (LinuxHub) security

The following operations are performed in the **Key** tab:

1. Viewing the dallas codes of video capture cards' cryptochips installed on LS (LH).
2. Viewing the information on the compliance of video capture card's dallas-codes with LS (LH)'s key file.

Note
intellect.sec is used for LS security, video.sec is used for LH security

3. Downloading the license key to LS (LH).

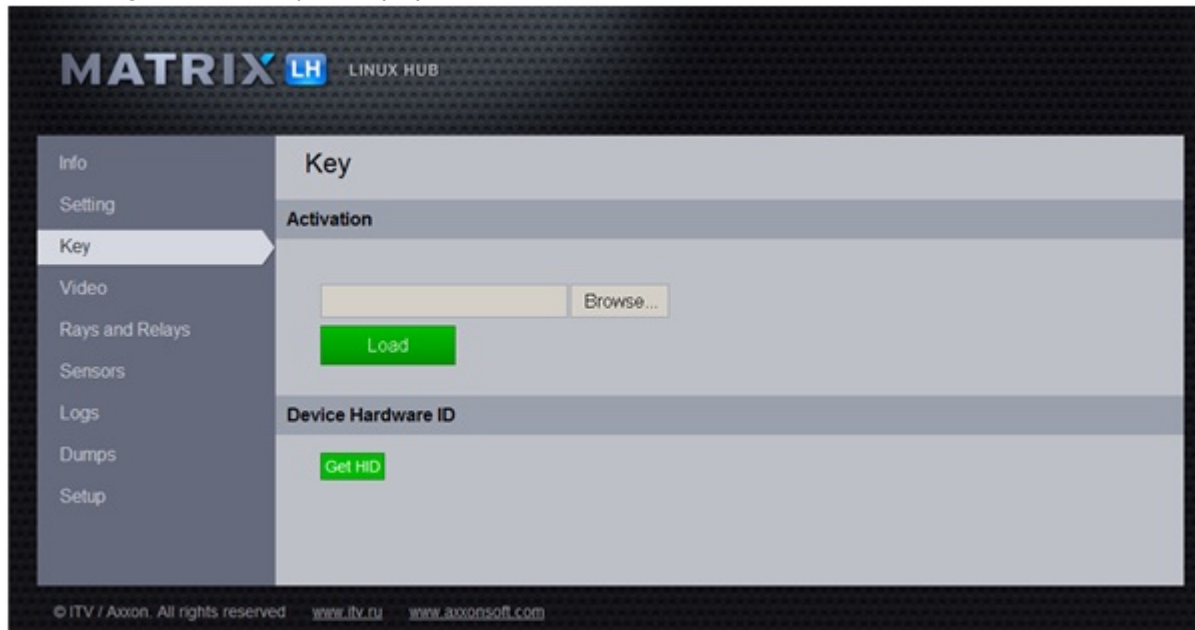

To download the license key to LS (LH), do the following:

1. Click **Browse** to select the license key.
2. Select the required file and click **Open** in the appeared standard dialog window of the Windows OS.
3. Click **Load**.
4. As a result the intellect.sec (video.sec) license key is saved on LS (LH) in the \etc\itv\ directory;
5. Restart LS (LH).

Attention!
The license key is not loaded in Mozilla Firefox.

Downloading the license key to LS (LH) is completed.

Resetting Linux Server (LinuxHub) configuration

The **Setup** tab allows resetting some configuration parameters of LS (LH).

Note
Online updating of the firmware is performed in the **Setup** tab (see [Updating Linux Server \(LinuxHub\) firmware](#) section).

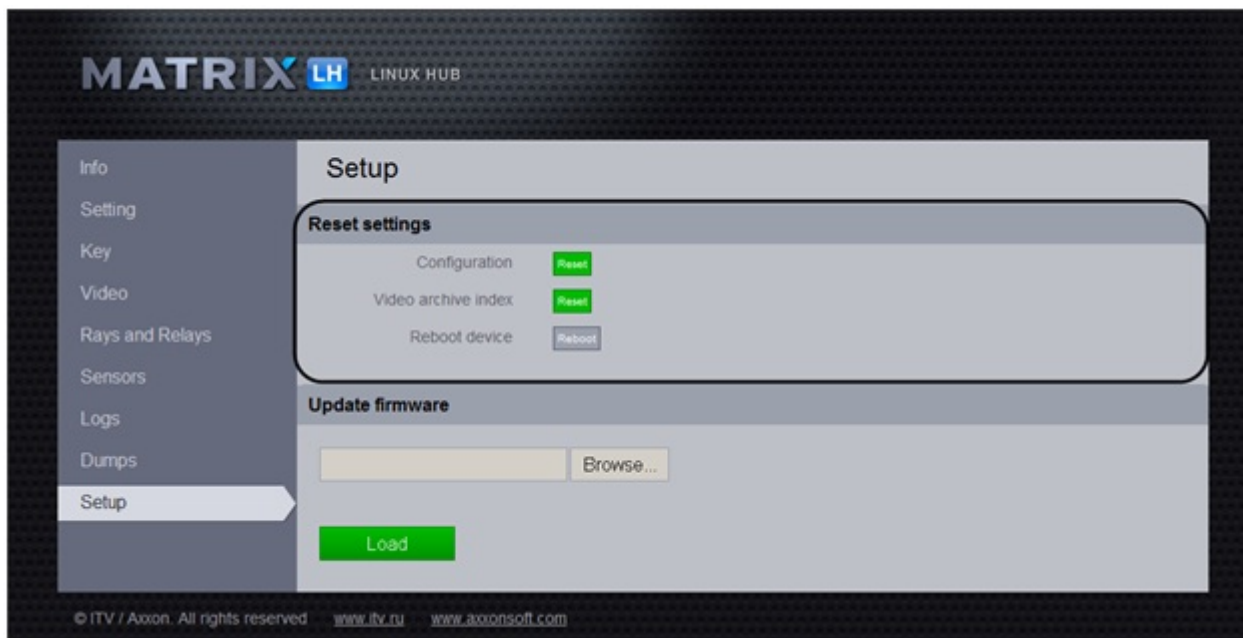

To reset the current LS (LH) configuration click the **Reset** button next to **Configuration**. The LS (LH) will reset the selected configuration parameters after restart. Click **Reboot** to restart LS (LH).

Configuration means hardware configuration received from *INTELLECT™*. Default configuration (available and licensed hardware) is created after reset and reboot; hardware configuration created on Server is applied after connecting *INTELLECT™*.

To reset LS(LH) database settings click the **Reset** button next to **Video archive index**. Settings will be reset after restart. To restart LS (LH) click the **Reboot** button.

Viewing Linux Server (LinuxHub) logs

Logs of LS (LH) are viewed in the **Logs** tab.

MATRIX LH LINUX HUB

Info
Setting
Key
Video
Rays and Relays
Sensors
Logs
Dumps
Setup

Dumps

Download	HttpServer_20-07-44_2012-03-06.dmp	5/31/2012 1:30:04 PM
Download	VideoServerCore_15-45-25_2012-03-15.dmp	5/31/2012 1:30:01 PM
Download	VideoServerCore_16-31-03_2012-02-10.dmp	5/31/2012 1:30:01 PM
Download	VideoServerCore_16-31-44_2012-02-21.dmp	5/31/2012 1:30:01 PM
Download	VideoServerCore_17-04-19_2012-02-07.dmp	5/31/2012 1:30:01 PM
Download	VideoServerCore_17-07-52_2012-02-22.dmp	5/31/2012 1:30:01 PM
Download	VideoServerCore_19-41-02_2012-05-10.dmp	5/31/2012 1:30:01 PM
Download	VideoServerCore_19-52-02_2012-05-10.dmp	5/31/2012 1:30:01 PM
Download	VideoServerCore_19-55-10_2012-05-10.dmp	5/31/2012 1:30:01 PM
Download	VideoServerCore_21-01-16_2012-02-24.dmp	5/31/2012 1:30:01 PM
Download	VideoServerCore_21-02-37_2012-02-16.dmp	5/31/2012 1:30:01 PM

© ITV / Axxon. All rights reserved www.itv.ru www.axxonsoft.com

The available dumps are displayed in the **Dumps** tab.

To save the dump click the **Download** button.

Updating Linux Server (LinuxHub) firmware

LS (LH) firmware is updated in the Web interface.

Attention!
Installing LS firmware on LH results in incorrect LH operation.

Note
The firmware can be updated locally using the .iso image.

To update LS (LH) firmware via the Web interface, do the following:

1. Go to the **Setup** tab.

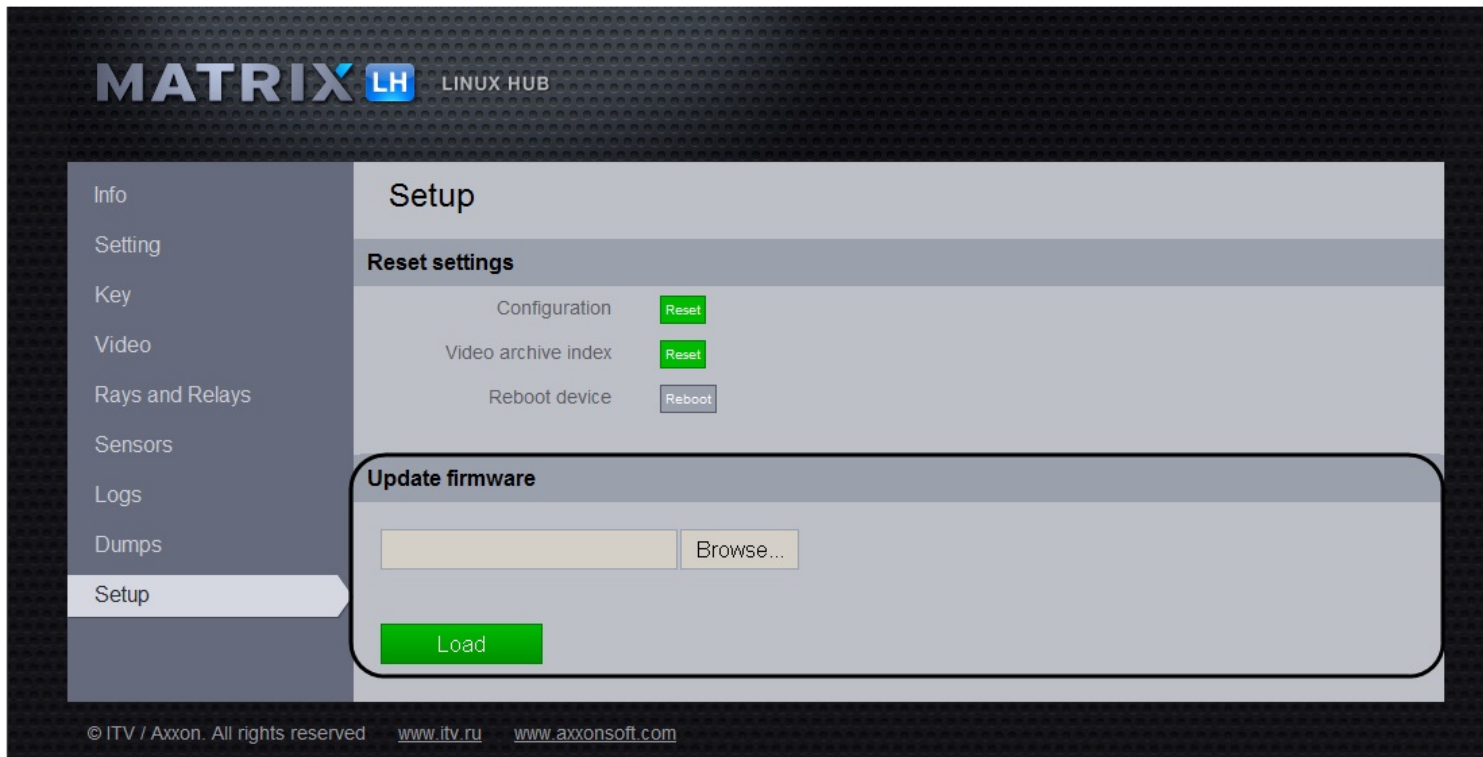

2. Click **Browse** to select the firmware file.

Note
To get the firmware file, please, contact AxxonSoft's Help desk.
The firmware file has the **.iso** extension.

3. Select the required firmware file and click **Open** in the standard dialog box.
4. Click **Load**.
5. As the result the firmware is loaded and installed on LS (LH).
6. Wait till the process ends and then restart LS (LH).

Updating LS (LH) firmware via the Web interface is completed.

Note
There is no need to restore network settings and LS(LH) license key while updating LS (LH) firmware in the Web interface.

Appendix 4. Technical specifications of video capture cards

On the page:

- Technical specifications of FS-5, FS-6, FS-16 and FS-8 video capture cards
- Technical specifications of WS-6, WS-7, SC390N16 (WS16) and WS-17 video capture cards
- Technical specifications of SC300D16 (FX8), SC200Q4 (FS15), SC300Q16 (FX4), SC310N16 (FX16), SC330Q16 and SC330D16 video capture cards
- Technical specifications of SC200Q4 Low profile (FS115), FX2, FX116, FX416 and SC230N4 video capture cards
- Technical specifications of SC3B0N16 (WS216), SC510N4 (FX HD4) and MS416 video capture cards
- Technical specifications of VRC6004, VRC6008, VRC6416, VRC7008L and VRC6404HD video capture cards
- Technical specifications of DS-4016HCI(R) and SC590N4 video capture card

Technical specifications of FS-5, FS-6, FS-16 and FS-8 video capture cards

Parameters	FS-5		FS-6		FS-16		FS-8	
PCI bus, bit / MHz	32 / 33, using PCI-66/X		32 / 33, using PCI-66/X		PCI E 1x		32 / 33, using PCI-66/X	
Supply voltage, V	3.3 and 5		3.3 and 5		3.3		3.3 and 5	
Power consumption, W	2		5		5		9	
Video inputs, V / Ohm	1 / 75		1 / 75		1 / 75		1 / 75	
Video output, V / Ohm	1 / 75		1 / 75		1 / 75		1 / 75	
Number of video inputs	16		16		16		16	
Hardware compression	no		no		no		no	
Analog video out	1 (optional)		1 (optional)		1 (optional)		1 (built-in)	
Signal type	CCIR PAL, NTSC		CCIR PAL, NTSC		CCIR PAL, NTSC		CCIR PAL, NTSC	
Resolution, pixels	PAL	NTSC	PAL	NTSC	PAL	NTSC	PAL	NTSC
	352*288	320*240	352*288	320*240	352*288	320*240	352*288	320*240
	704*288	640*240	704*288	640*240	704*288	640*240	704*288	640*240
	704*576	640*480	704*576	640*480	704*576	640*480	704*576	640*480
Resolution, TV lines (b/w, color)	480		480		480		480	
Color palette	16 mln colors, 256 shades of gray		16 mln colors, 256 shades of gray		16 mln colors, 256 shades of gray		16 mln colors, 256 shades of gray	

Number of multiplexed video inputs	16	16	16	16
Number of non-multiplexed (live) video inputs	1	4	4	8
Video input rate for each non-multiplexed channel, fps, PAL (NTSC)	25 (30)	25 (30)	25 (30)	25 (30)
Total video input rate for all multiplexed channels, fps, PAL	16 (704x288, 352x288) 12 (704x576)	64 (704x288, 352x288) 48 (704x576)	64 (704x288, 352x288) 48 (704x576)	128 (704x288, 352x288) 96 (704x576)
Total video input rate for all multiplexed channels, fps, NTSC	20 (640x240, 320x240) 15 (640x480)	80 (640x240, 320x240) 60 (640x480)	80 (640x240, 320x240) 60 (640x480)	160 (640x240, 320x240) 120 (640x480)
Total video input rate for all non-multiplexed channels, fps, PAL (NTSC)	25 (30)	100 (120)	100 (120)	200 (240)
Galvanic isolation of sensor lines	4(16), 2000 V	4 (16), 2000 V	4 (16), 2000 V	4 (16), 2000 V
Galvanic isolation of control outputs	4, 24 V, 30 mA	4, 24 V, 30 mA	4, 24 V, 30 mA	4, 24 V, 30 mA
Number of audio input/output channels	2 x RCA/ -	8 x RCA/ -	8 x RCA/ -	16 x RCA/ -
Audio digitizing frequency, kHz	8, 16, 32	8, 16, 32	8, 16, 32	8, 16, 32
Watchdog, hardware control of OS hanging-up	yes	yes	yes	yes
Digital-analog conversion, bit	9	9	9	9

Technical specifications of WS-6, WS-7, SC390N16 (WS16) and WS-17 video capture cards

Parameters	WS-6		WS-7		SC390N16 (WS16)*		WS-17	
PCI bus, bit / MHz	32 / 33, using PCI-66/X		32 / 66(33)		1x		1x	
Supply voltage, V	3,3 and 5		3,3		-		3,3	
Power consumption, W	4		8		3,3		8	
Video inputs, V / Ohm	1 / 75		1 / 75		1 / 75		1 / 75	
Video output, V / Ohm	no		no		no		no	
Number of video inputs	4		4		16		4	
Hardware compression	yes		yes		yes		yes	
Analog video out	no		no		no		no	
Signal type	PAL, NTSC		PAL, NTSC		PAL, NTSC		PAL, NTSC	
Resolution, pixels	PAL	NTSC	PAL	NTSC	PAL	NTSC	PAL	NTSC
	704*544	640*480	704*288	640*240	352*288	352*240	352*288	320*240
			704*544	640*480	704*288	704*240	704*288	640*240
					704*576	704*480	704*544	640*480
Resolution, TV lines (b/w, color)	500 (500)		500 (500)		625 (PAL)/525(NTSC)		500 (500)	
Color palette	16 mln colors, 256 shades of gray		16 mln colors, 256 shades of gray		16 mln colors, 256 shades of gray		16 mln colors, 256 shades of gray	
Number of multiplexed video inputs	-		-		-		-	

Number of non-multiplexed (live) video inputs	4	4	16	4
Video input rate for each non-multiplexed channel, fps, PAL (NTSC)	25 (30)	25 (30)	25 (30)	25 (30)
Total video input rate for all multiplexed channels, fps, PAL	-	-	-	-
Total video input rate for all multiplexed channels, fps, NTSC	-	-	-	-
Total video input rate for all non-multiplexed channels, fps, PAL (NTSC)	100 (120)	100 (120)	400(480)	100 (120)
Galvanic isolation of sensor lines	no	no	no	no
Galvanic isolation of control outputs	no	no	no	no
Number of audio input/output channels	8 x RCA/ -	8 x RCA/ -	16 x RCA/ -	8 x RCA/ -
Audio digitizing frequency, kHz	16	8, 16	8	8,16
Watchdog, hardware control of OS hanging-up	no	no	no	no
Digital-analog conversion, bit	9	9	10	9



Note

Resolutions supported by WS16 video capture card are given in the table for archive recording and for displaying video on the Client. On the Server video is displayed only with 352x288 (PAL) / 352x240 (NTSC) resolution

Technical specifications of SC300D16 (FX8), SC200Q4 (FS15), SC300Q16 (FX4), SC310N16 (FX16), SC330Q16 and SC330D16 video capture cards

Parameters	SC300D16 (FX8)		SC200Q4 (FS15)		SC300Q16 (FX4)		SC310N16 (FX16)		SC330Q16		SC330D16	
Size (mm x mm)	132,22 x 80		120.55 x 85		132,22 x 80		179.97 x 106.65		132,22 x 80		132,22 x 80	
Minimal requirements to the input/output bus, standard	PCI-E x 1		PCI (33MHZ)		PCI-E x 1		PCI-E x 4 (33MHZ)		PCI-E x 1		PCI-E x 1	
ADC (bit)	10		10		10		10		10		10	
Number of video inputs	16 x BNC		4 x BNC		16 x BNC		16 x BNC		16 x BNC		16 x BNC	
Hardware compression	no		no		no		no		no		no	
Analog video out	no		no		no		no		no		no	
Power consumption, W	4		0,5		4		5,5		4		4	
Video inputs, V / Ohm	1/75		1/75		1/75		1/75		1/75		1/75	
Video output, V / Ohm	1/75		1/75		1/75		1/75		1/75		1/75	
Audio input, V/ kOhm	1/40		1/40		1/40		3,5/10		1/40		1/40	
Signal type	PAL, NTSC		PAL, NTSC		PAL, NTSC		PAL, NTSC		PAL, NTSC		PAL, NTSC	
Resolution, pixels	PAL	NTSC	PAL	NTSC	PAL	NTSC	PAL	NTSC	PAL	NTSC	PAL	NTSC
	352*288	320*240	352*288	320*240	352*288	320*240	352*288	320*240	352*288	320*240	352*288	320*240
	704*288	640*240	704*288	640*240	704*288	640*240	704*288	640*240	704*288	640*240	704*288	640*240
	704*576	640*480	704*576	640*480	704*576	640*480	704*576	640*480	704*576	640*480	704*576	640*480
Maximum resolution, TV lines (b/w, color)	576 (PAL) / 480 (NTSC)		576 (PAL) / 480 (NTSC)		470		625 (PAL) / 525 (NTSC)		600		600	
Color palette	16 mln colors, 256 shades of gray		16 mln colors, 256 shades of gray		16 mln colors, 256 shades of gray		16 mln colors, 256 shades of gray		16 mln colors, 256 shades of gray		16 mln colors, 256 shades of gray	
Number of multiplexed video inputs	16		4		16		-		16		16	

Number of non-multiplexed (live) video inputs	8	1	4	16	4	8
Video input rate for each non-multiplexed channel, fps, PAL (NTSC)	25 (30)	25 (30)	25 (30)	25 (30)	25 (30)	25 (30)
Total video input rate for all multiplexed channels, fps, PAL	128 (704x288, 352x288) 128 (704x576)	16 (704x288, 352x288) 16 (704x576)	64 (704x288, 352x288) 64 (704x576)	-	64 (704x288, 352x288) 64 (704x576)	128 (704x288, 352x288) 128 (704x576)
Total video input rate for all multiplexed channels, fps, NTSC	160(640x240, 320x240) 160(640x480)	20(640x240, 320x240) 20(640x480)	80(640x240,320x240) 80(640x480)	-	80(640x240,320x240) 80(640x480)	160(640x240, 320x240) 160(640x480)
Total video input rate for all non-multiplexed channels, fps, PAL (NTSC)	200 (240)	25 (30)	100 (120)	400(480)	100 (120)	200 (240)
Number of audio input/output channels	8 x RCA/ -	1 x TRS/ -	4 x RCA/ -	16 x RCA/ -	4 x RCA/ -	8 x RCA/ -
Audio digitizing frequency, kHz	8, 16, 24, 32, 40, 48	8, 16, 24, 32, 40, 48	8, 16, 24, 32, 40, 48	8, 16, 24, 40, 48	8, 16, 24, 32, 40, 48	8, 16, 24, 32, 40, 48
Galvanic isolation of sensor lines	4	not integrated	4	4	4	4
Control outputs, open collector	4	not integrated	4	4	4	4
Watchdog, hardware control of OS hanging-up	yes	yes	yes	yes	yes	yes
Peak temperature of card	50 ⁰ C	40 ⁰ C	40 ⁰ C	65 ⁰ C	40 ⁰ C	50 ⁰ C
Supported OS	All OS supported by the INTELLECT™ system	All OS supported by the INTELLECT™ system	All OS supported by the INTELLECT™ system	All OS supported by the INTELLECT™ system	All OS supported by the INTELLECT™ system	All OS supported by the INTELLECT™ system

Technical specifications of SC200Q4 Low profile (FS115), FX2, FX116, FX416 and SC230N4 video capture cards

Parameters	SC200Q4 Low profile (FS115)		FX2		FX116		FX416		SC230N4	
Minimal requirements to the input/output bus, standard	PCI		PCI-E x 1		PCI-E x 1		PCI-E x 4		PCI	
ADC (bit)	10		9		10		10		10	
Number of video inputs	4 x BNC		8 x BNC		16 x BNC		16 x BNC		4 x BNC	
Hardware compression	no		no		no		no		no	
Analog video out	no		1 (optionally)		no		no		no	
Power consumption, W	0,5		3		1,5		1,8		4	
Video inputs, V / Ohm	1/75		1/75		1/75		1/75		1/75	
Video outputs, V / Ohm	1/75		1/75		1/75		1/75		1/75	
Audio input, V/ kOhm	1/40		1,4 / 5		1/10		1/10		1/40	
Signal type	PAL, NTSC		PAL, NTSC		PAL, NTSC		PAL, NTSC		PAL, NTSC	
Resolution, pixels	PAL	NTSC	PAL	NTSC	PAL	NTSC	PAL	NTSC	PAL	NTSC
	352*288	320*240	352*288	320*240	352*288	320*240	352*288	352*240	352*288	320*240
	704*288	640*240	704*288	640*240	704*288	640*240	704*288	704*240	704*288	640*240
	704*576	640*480	704*576	640*480	704*576	640*480	704*576	704*480	704*576	640*480
Maximum resolution, TV lines (b/w, color)	576 (PAL) / 480 (NTSC)		480		420		625 (PAL) / 525 (NTSC)		576 (PAL) / 480 (NTSC)	
Color palette	16 mln colors, 256 shades of gray		16 mln colors, 256 shades of gray		16 mln colors, 256 shades of gray		16 mln colors, 256 shades of gray		16 mln colors, 256 shades of gray	

Number of multiplexed video inputs	4	8	16	-	-
Number of non-multiplexed (live) video inputs	1	2	8	16	4
Video input rate for each non-multiplexed channel, fps, PAL (NTSC)	25 (30)	25 (30)	25 (30)	25 (30)	25(30)
Total video input rate for all multiplexed channels, fps, PAL	16 (704x288, 352x288) 16 (704x576)	32 (704x288, 352x288) 24 (704x576)	128 (704x576)	-	-
Total video input rate for all multiplexed channels, fps, NTSC	20(640x240, 320x240) 20(640x480)	40(640x240,320x240) 30(640x480)	160(640x480)	-	-
Total video input rate for all non-multiplexed channels, fps, PAL (NTSC)	25 (30)	50 (60)	200 (240)	400 (480)	100 (120)
Number of audio inputs/outputs channels	1 x RCA/ -	4 x RCA/ -	16 x RCA/ -	16 x RCA/ -	4 x RCA / -
Audio digitizing frequency, kHz	8, 16, 24, 32, 40, 48	8, 16, 32	8, 16	8, 16	8, 16, 24, 32, 40, 48
Galvanic isolation of sensor lines	4	4 (16), 2000 V	not integrated	not integrated	4
Control outputs, open collector	4	4, 24 V, 30 mA	not integrated	not integrated	4
Watchdog, hardware control of OS hanging-up	yes	yes	yes	yes	yes
Supported OS	All OS supported by the INTELLECT™ system	All OS supported by the INTELLECT™ system	All OS supported by the INTELLECT™ system	All OS supported by the INTELLECT™ system	All OS supported by the INTELLECT™ system

Technical specifications of SC3B0N16 (WS216), SC510N4 (FX HD4) and MS416 video capture cards

Parameters	SC3B0N16 (WS216)*		SC510N4 (FX HD4)	MS416	
Minimal requirements to the input/output bus, standard	PCI-E x 1		PCI-Ex4	PCI-Ex4	
ADC (bit)	10		-	10	
Number of video inputs	16		4	16 x BNC	
Hardware compression	yes		no	no	
Analog video out	no		no	no	
Power consumption, W	3,3		3,3	1,8	
Video inputs, V / Ohm	1/75		-	1/75	
Video outputs, V / Ohm	-		-	1/75	
Signal type	PAL, NTSC		-	PAL, NTSC	
Resolution, pixels	PAL	NTSC	1920*1080, 1280*720 - noninterlaced scan 1280*720 - interlaced scan	PAL	NTSC
	352*288	352*240		352*288	320*240
	704*288	704*240		704*288	640*240
	704*576	704*480		704*576	640*480
Maximum resolution, TV lines (b/w, color)	576 (PAL) / 480 (NTSC)		-	625 (PAL) / 525 (NTSC)	

Color palette	16 mln colors, 256 shades of gray	16 mln colors, 256 shades of gray	16 mln colors, 256 shades of gray
Number of multiplexed video inputs	-	-	-
Number of non-multiplexed (live) video inputs	16	4	16
Total video input rate for all non-multiplexed channels, fps, PAL (NTSC)	25 (30)	25 (1920x1080 resolution) 50 (1280x720 resolution)	25 (30)
Total video input rate for all multiplexed channels, fps, PAL (NTSC)	-	200 (1280x720 resolution) 100 (1920x1080 resolution)	-
Total video input rate for all non-multiplexed channels, fps, PAL (NTSC)	400 (480)	200 (1280x720 resolution) 100 (1920x1080 resolution)	400 (480)
Number of audio inputs/outputs channels	16 x RCA/ -	4 x HDMI/ 4 x HD SDI	32 x RCA/ -
Audio digitizing frequency, kHz	8	32 - 48	48
Galvanic isolation of sensor lines	4	not integrated	not integrated
Control outputs, open collector	4	not integrated	not integrated
Watchdog, hardware control of OS hanging-up	yes	yes	yes
Supported OS	All OS supported by the INTELLECT™ system	All OS supported by the INTELLECT™ system	All OS supported by the INTELLECT™ system

Note
Resolutions supported by WS26 video capture card are given in the table for archive recording and displaying video on the Client. On the Server video is displayed only with 352x288 (PAL) / 352x240 (NTSC) resolution

Note.
In order to use SC3B0N16 video capture card in Windows Server 2012 R2 enable the *Desktop Experience*. Find information on how to work with this component at [https://tech.net.microsoft.com/en-us/library/cc754314\(v=ws.11\).aspx](https://tech.net.microsoft.com/en-us/library/cc754314(v=ws.11).aspx)

Note
When WS216 video capture card with h.264 compression is in use, recording to the archive is in the colour mode. Black-and-white mode is not supported

Technical specifications of VRC6004, VRC6008, VRC6416, VRC7008L and VRC6404HD video capture cards

Parameters	Stretch VRC6004	Stretch VRC6008	Stretch VRC6416	Stretch VRC7008L	Stretch VRC6404HD
Interface	PCI-E 1x	PCI-E 1x	PCI-E 4x	PCI-E 1x	PCI-E 4x
Number of video inputs	4	8	16	8	4
Number of video channels for H264 Svc format	3 (channel 4 is disabled)	6 (channels 4 and 8 are disabled)	12 (channels 4, 8, 12 and 16 are disabled)	8	4

Signal type	PAL, NTSC		PAL, NTSC		PAL, NTSC		PAL, NTSC		PAL, NTSC
Resolution, pixels	PAL	NTSC	PAL	NTSC	1920*1072 960*528 480*256	NTSC	PAL	NTSC	1920*1072 960*528 480*256
	720*576	720*480	720*576	720*480		720*480	720*576	720*480	
	704*576	704*480	704*576	704*480		704*480	704*576	704*480	
	528*384	528*320	528*384	528*320		528*320	528*384	528*320	
	360*288	360*240	360*288	360*240		360*240	352*288	352*240	
	180*144	180*120	180*144	180*120		180*120	176*144	176*120	
Recording rate for each channel	25fps PAL / 30fps NTSC		25fps PAL / 30fps NTSC		25fps PAL / 30fps NTSC		25fps PAL / 30fps NTSC		25fps PAL / 30fps NTSC
Video compression format	H.264 AVC/H.264 SVC / MJPEG / MPEG		H.264 AVC/H.264 SVC / MJPEG / MPEG		H.264 AVC/H.264 SVC / MJPEG / MPEG		H.264 AVC/H.264 SVC / MJPEG / MPEG		H.264 AVC / H.264 SVC / MPEG4 / MJPEG
Recording rate for each channel for H264 Svc format	12fps PAL / 15fps NTSC		12fps PAL / 15fps NTSC		12fps PAL / 15fps NTSC		25fps PAL / 30fps NTSC		25fps PAL / 30fps NTSC
Number of audio in/out channels	-		8 x RCA/ -		16 x RCA/ -		8 x RCA/ -		4 x BNC/-
Number of audio channels (input) for H264 Svc format	-		6 (channels 4 and 8 are disabled)		12 (channels 4, 8, 12 and 16 are disabled)		8		4
Audio compression format	-		G.711		G.711		G.711		G.711
Analog video out modes	-		NTSC / PAL Analog "Rolling" SMO		-		1CVBS		-
Video out pin	-		BNC		-		DVI		BNC
Video pre-preprocessing	De-interlacing; Titling by user; Stretch Bilateral Filter (additionally)		De-interlacing; Titling by user; Stretch Bilateral Filter (additionally)		De-interlacing; Titling by user; Stretch Bilateral Filter (additionally)		De-interlacing; Titling by user; Stretch Bilateral Filter (additionally)		De-interlacing; Titling by user; Stretch Bilateral Filter (additionally)
Analytics	Motion detector;		Motion detector;		Motion detector;		Motion detector;		Motion detector;
	Flash and break-in detector; Night mode detector		Flash and break-in detector; Night mode detector		Flash and break-in detector; Night mode detector		Flash and break-in detector; Night mode detector		Flash and break-in detector; Night mode detector
Alarm system and triggers support (available in additional daughter cards)	8 optically isolated inputs; 8 relay outputs		8 optically isolated inputs; 8 relay outputs		8 optically isolated inputs; 8 relay outputs		8 optically isolated inputs; 8 relay outputs		16 optically isolated inputs; 16 relay outputs
Certificates	FCC, CE		FCC, CE		FCC, CE		-		FCC, CE

Minimal requirements to processor	Dual Core 2.4 GHz or equivalent	Dual Core 2.4 GHz or equivalent	Dual Core 2.4 GHz or equivalent	Dual Core 2.4 GHz or equivalent	Dual Core 2.4 GHz or equivalent
Minimal requirements to RAM(Gb)	1	1	1	1	1
Supported OS	All OS supported by the INTELLECT™ system	All OS supported by the INTELLECT™ system	All OS supported by the INTELLECT™ system	All OS supported by the INTELLECT™ system	All OS supported by the INTELLECT™ system

Technical specifications of DS-4016HCI(R) and SC590N4 video capture card

Parameters	DS-4016HCI(R)		SC590N4
Minimal requirements to the input/output bus, standard	PCI		PCI Express 1x
Size (mm x mm)	198 x 100		189 x 90
Number of video channels	16		4
Video input interface	BNC (1.0Vp-p, 75Ω)		HD SDI
Maximum fps for a channel	25fps (PAL)/30 fps (NTSC)		50 fps (PAL) / 60 fps (NTSC)
Resolution at recording, pixels	PAL	NTSC	1920x1080 @ 30/25/24fps
	704 * 576	704 * 480	1920x1080 @ 50/60fps
	704*288	704*240	1280x720 @ 30/25/24fps
	352 * 288	352 * 240	1280x720 @ 50/60fps
Resolution under compression, pixels	PAL	NTSC	-
	704 * 576	704 * 480	
	704*288	704*240	
	352 * 288	352 * 240	
Data rate for one video channel	32Kbps ~ 2Mbps		-
Number of non-multiplexed (live) video inputs	-		4
Total video input rate for all non-multiplexed channels	-		120fps @ 1920x1080i
Color palette	-		16 mln colors, 256 shades of gray
Video compression format	H.264 orI420		H.264 Main Profile
Number of audio channels	16		4 x SDI + 2 x 3.5mm jack, while maximum number of channels is 4 (see Features of audio subsystem configuration).

Audio compression format	OggV or bis, 16Kbps		Stereo / 16-bit / 48000Hz
Audio input interface	BNC(2Vp-p, 1kΩ)		SDI, 3.5mm jack
Video/audio output	yes		yes
Resolution of preview, pixels	PAL	NTSC	960x540 @ 30/25/24fps
	704 * 576	704 *480	960x540 @ 50/60fps 640x360 @ 30/25/24fps 640x360 @ 50/60fps
Dual stream	yes		yes
Power consumption	Less then 9W		-
Peak temperature	from -10°C to +50°C		-
Humidity	10%~90%		-
DI / DO (rays and relays)	no		16 (8 rays and 8 relays)
Watchdog, hardware control of OS hanging-up	no		yes
Supported OS	All OS supported by the INTELLECT™ system		All OS supported by the INTELLECT™ system

Note. Using the SC590N4 Video capture card with h.264 compression format the record to archive is performed in color mode. Black and white mode of record is not supported. Also, the card sends separate streams with different resolution for displaying and recording to the archive.

Note. While configuring the video camera which is connected through the SC590N4 video capture card, in the *Intellect* software the frame resolution is to be set as the resolution set on the video camera. Otherwise, artefacts can appear on the video image.

Note. In order to use SC590N4 video capture card in Windows Server 2012 R2 enable the *Desktop Experience*. Find information on how to work with this component at [https://technet.microsoft.com/en-us/library/cc754314\(v=ws.11\).aspx](https://technet.microsoft.com/en-us/library/cc754314(v=ws.11).aspx)

Note DS-4016HCI(R) video capture card has an embedded motion detector that is not integrated at the time of writing this manual

Note At the time of writing this manual audio is not integrated for DS-4016HCI(R) video capture card

Appendix 5. Video capture cards pins

FS-5 video capture card pins

FS-5 video capture card has 3 external pins- two RCA pins and a D-SUB-25 pin. Video connection is performed to the D-SUB-25 pin with the help of D-SUB-25/BNC stub. Simultaneous connection of up to 16 cameras is possible. Sound connection is performed with the help of RCA pins (two sound sources are maximum possible). Analog output card is connected to J2, J7, J8 pins. The Watchdog cable is connected to the J1 pin.

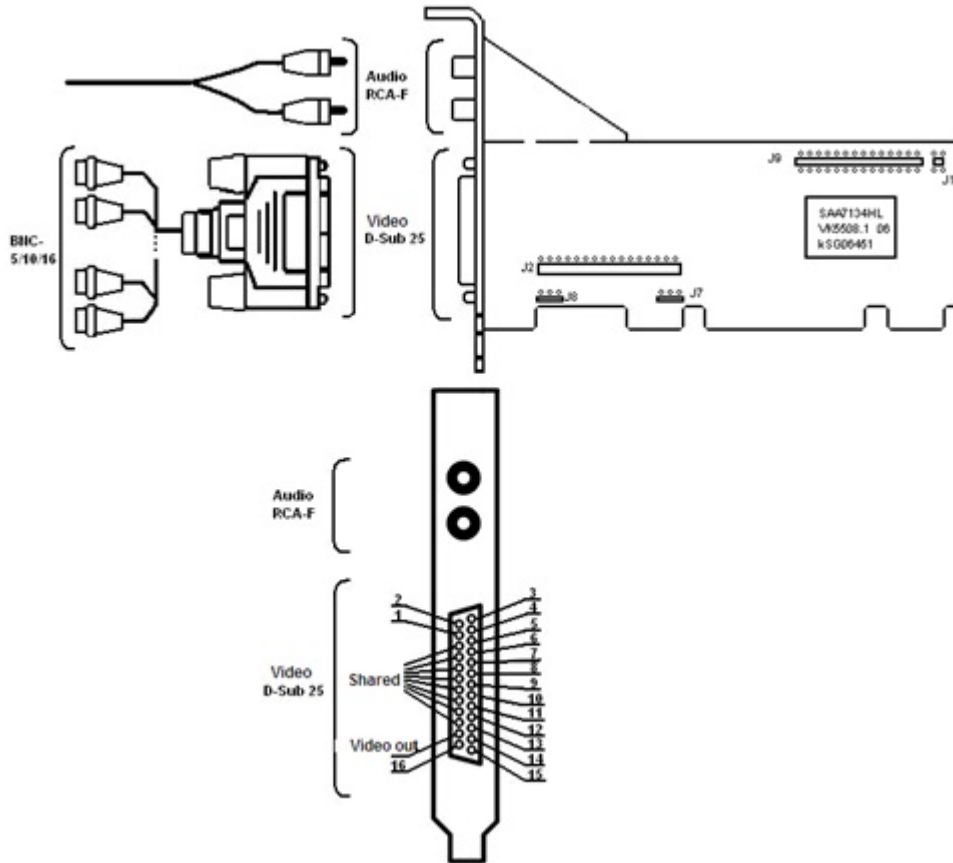

FS-6 video capture card pins

FS-6 video capture card has 2 external pins - D-SUB-9 and D-SUB-25. Video connection is performed with the help of D-SUB-25/BNC stub. Simultaneous connection of up to 16 cameras is possible. D-SUB-9/RCA-8 interface cable is used for connecting the audio channels (up to 8 sound sources simultaneously) to the external D-SUB-9 pin of FS-6 video capture card. Analog output card is connected to J2, J7, J8 pins. The Watchdog cable is connected to the J1 pin.

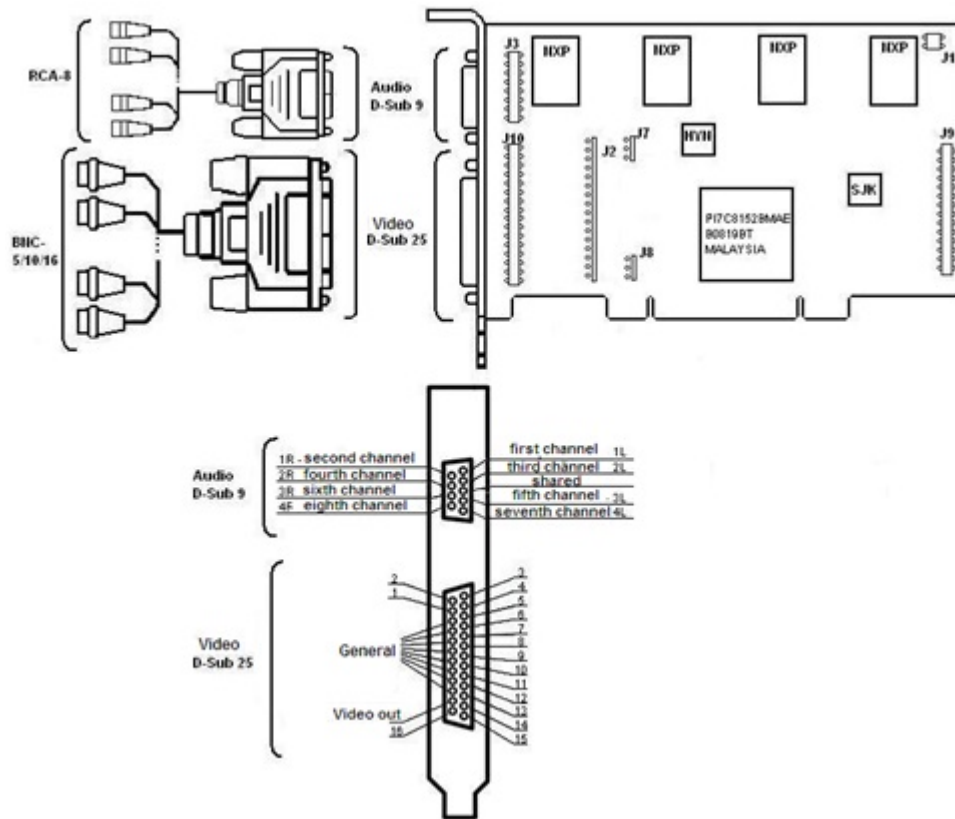

FS-16(Exp) video capture card pins

FS16 (Exp) video capture card has 2 external pins - D-SUB-9 and D-SUB-25. Video connection is performed with the help of D-SUB-25/BNC stub. Simultaneous reception of up to 16 video images is possible. D-SUB-9/RCA-8 interface cable is used for connecting the audio channels to the external D-SUB-9 pin of FS16 (Exp) video capture card (up to 8 sound sources simultaneously). Analog output card is connected to J2, J7, J8 pins. The Watchdog cable is connected to the J1 pin.

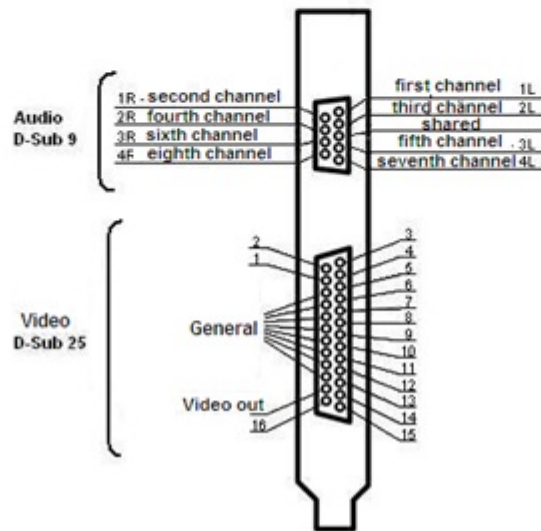
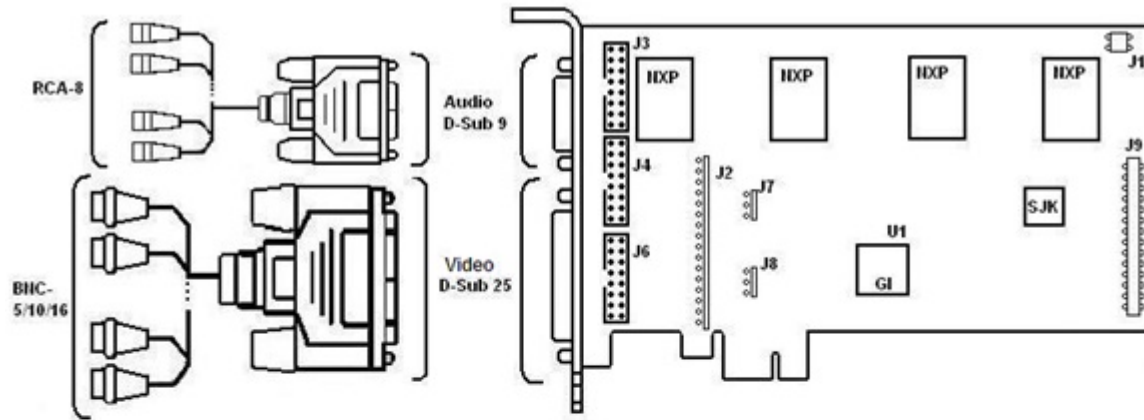

FS-8 video capture card pins

FS-8 video capture card has two external pins - D-SUB-9 and D-SUB-25 and one internal pin - IDC-16. Video connection is performed with the help of D-SUB-25/BNC stub via D-SUB-25 pin. Simultaneous reception of up to 16 video images is possible. D-SUB-9/RCA-8 interface cable is used for connecting the audio channels to the external D-SUB-9 pin of FS-8 video capture card (up to 8 sound sources simultaneously). IDC-16/D-SUB-9 bracket of sound extension is used (up to 8 sound sources simultaneously) to connect additional audio channels. It is connected to the internal IDC-16 pin of FS-8 video capture card. The Watchdog cable is connected to the J1 pin.

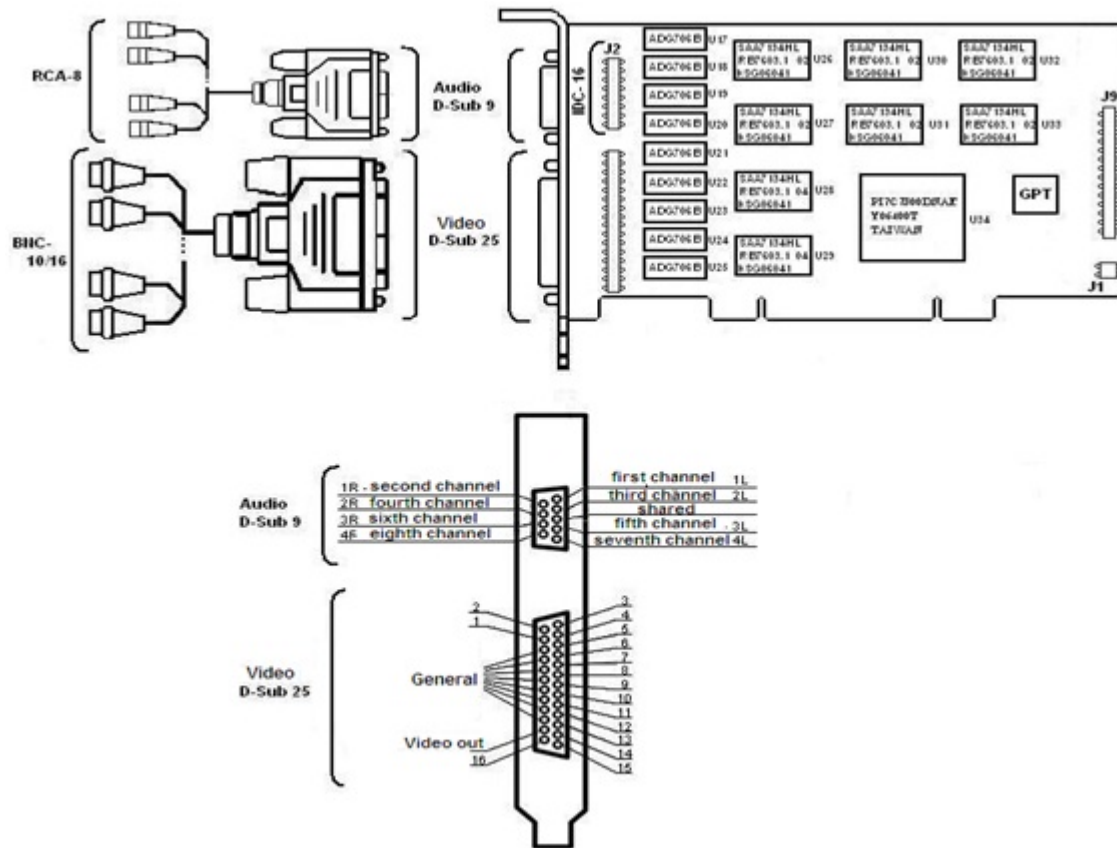

WS-7 video capture card pins

WS-7 video capture card has two external pins - D-SUB-9 and D-SUB-25. D-SUB-25/BNC interface cable is used for simultaneous connection of 4 cameras to the external D-SUB-25 pin of WS-7 video capture card. D-SUB-9/RCA interface cable is used for simultaneous connection of 4 audio channels to the external D-SUB-9 pin of WS-7 video capture card.

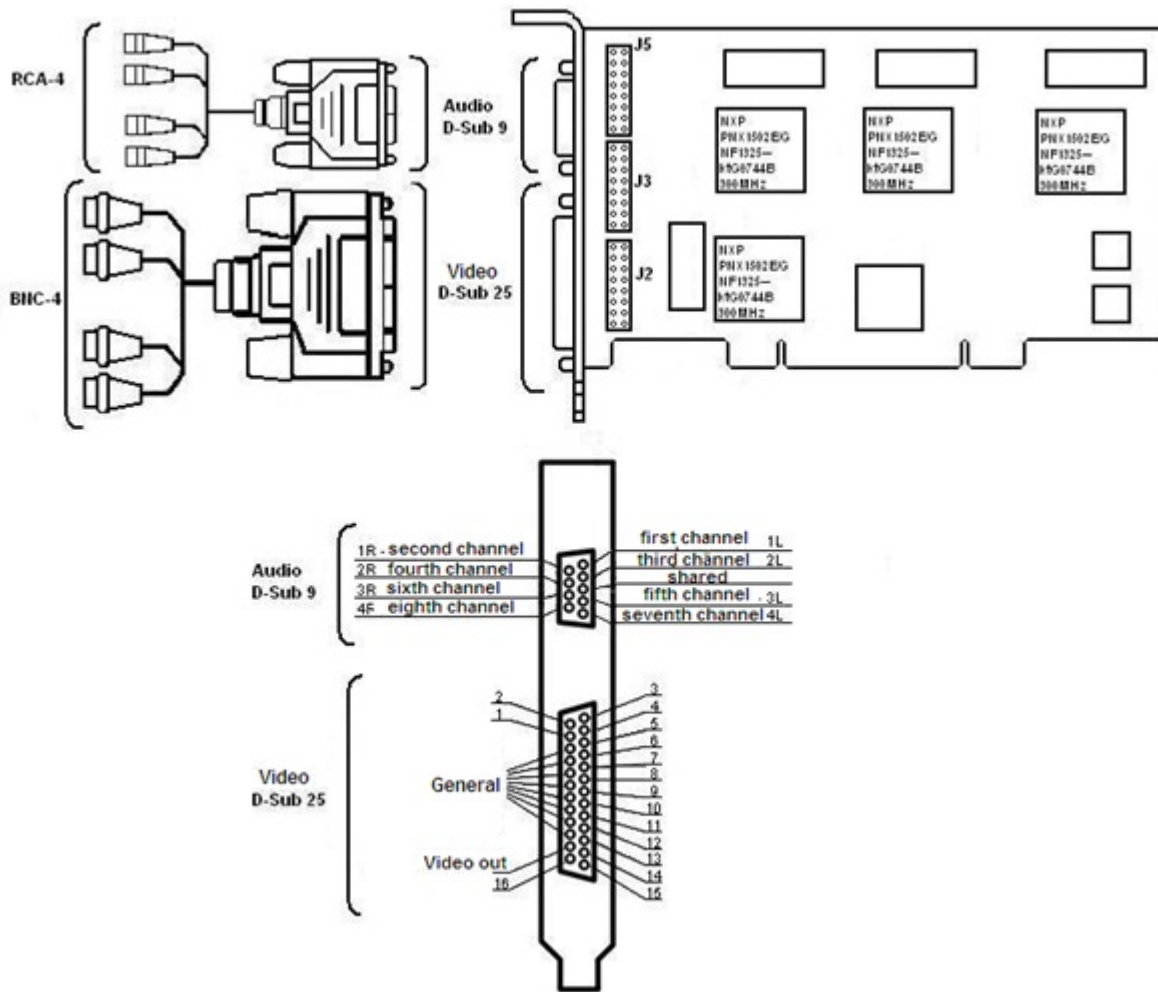

SC390N16 (WS-16) video capture card pins

SC390N16 (WS-16) video capture card has two external DVI-I pins. Video and audio connection is performed with the help of DVI-I/BNC and DVI-I/RCA stubs correspondingly. Simultaneous connection of up to 8 cameras and up to 8 sound sources to one external pin of SC390N16 (WS-16) video capture card is possible. The Watchdog cable is connected to the J1 pin.

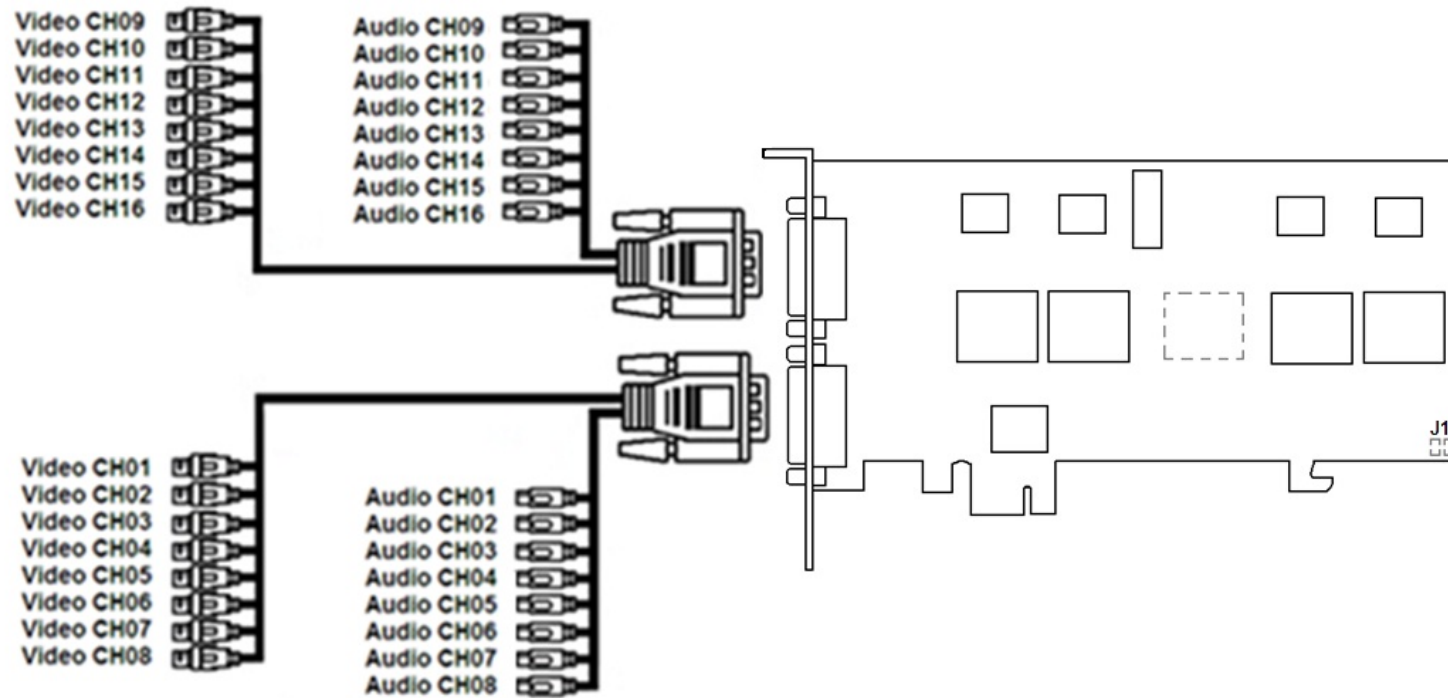

WS-17 video capture card pins

WS-17 video capture card has two external pins - D-SUB-9 and D-SUB-25. D-SUB-25/BNC interface cable is used for simultaneous connection up to 4 cameras to the external D-SUB-25 pin of WS-17 video capture card. D-SUB-9/RCA interface cable is used for simultaneous connection up to 4 audio channels to the external D-SUB-9 pin of WS-17 video capture card.

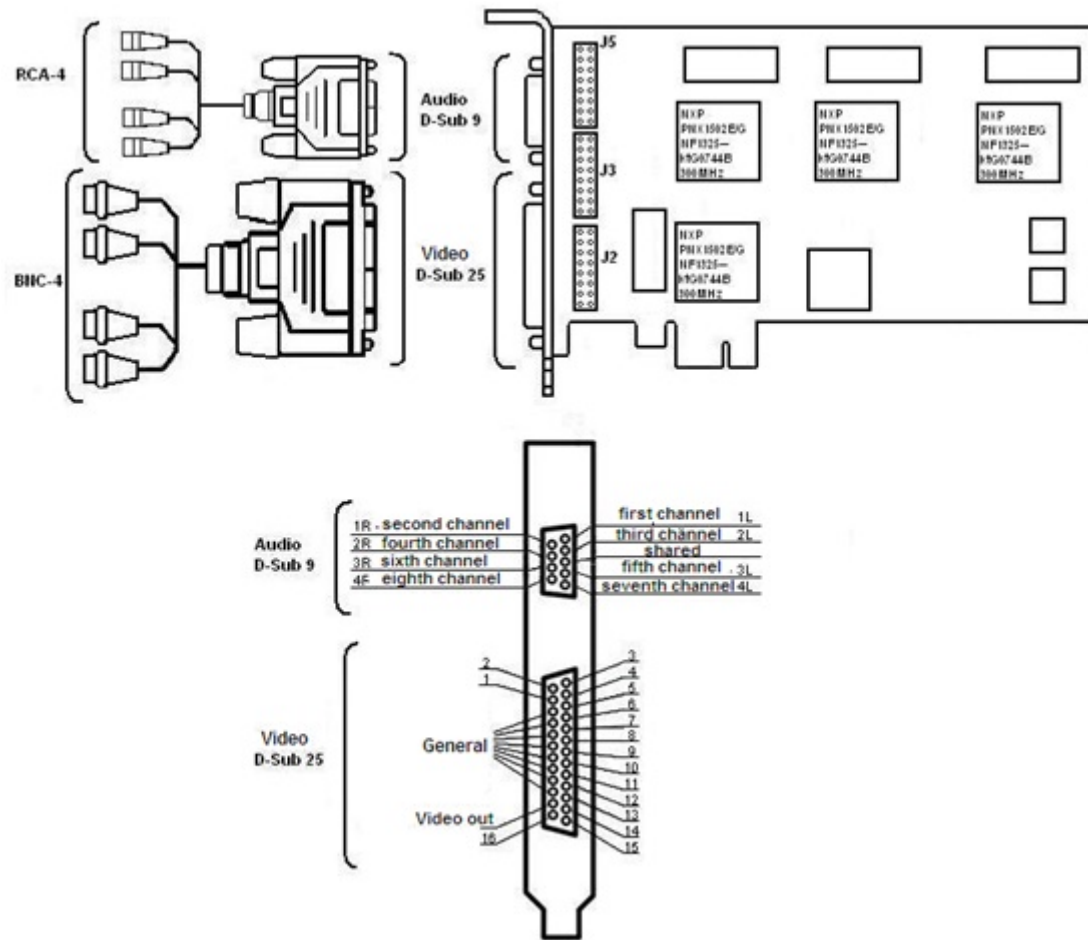

SC3B0N16 (WS216) video capture card pins

SC3B0N16 (WS216) video capture card has two external DVI-I pins. Video and audio connection is performed with the help of DVI-I/BNC and DVI-I/RCA stubs correspondingly. Simultaneous connection of up to 8 cameras and up to 8 sound sources to one external pin of SC3B0N16 (WS216) video capture card is possible. The Watchdog cable is connected to the J1 pin. DI/DO card is connected to the J2 pin.

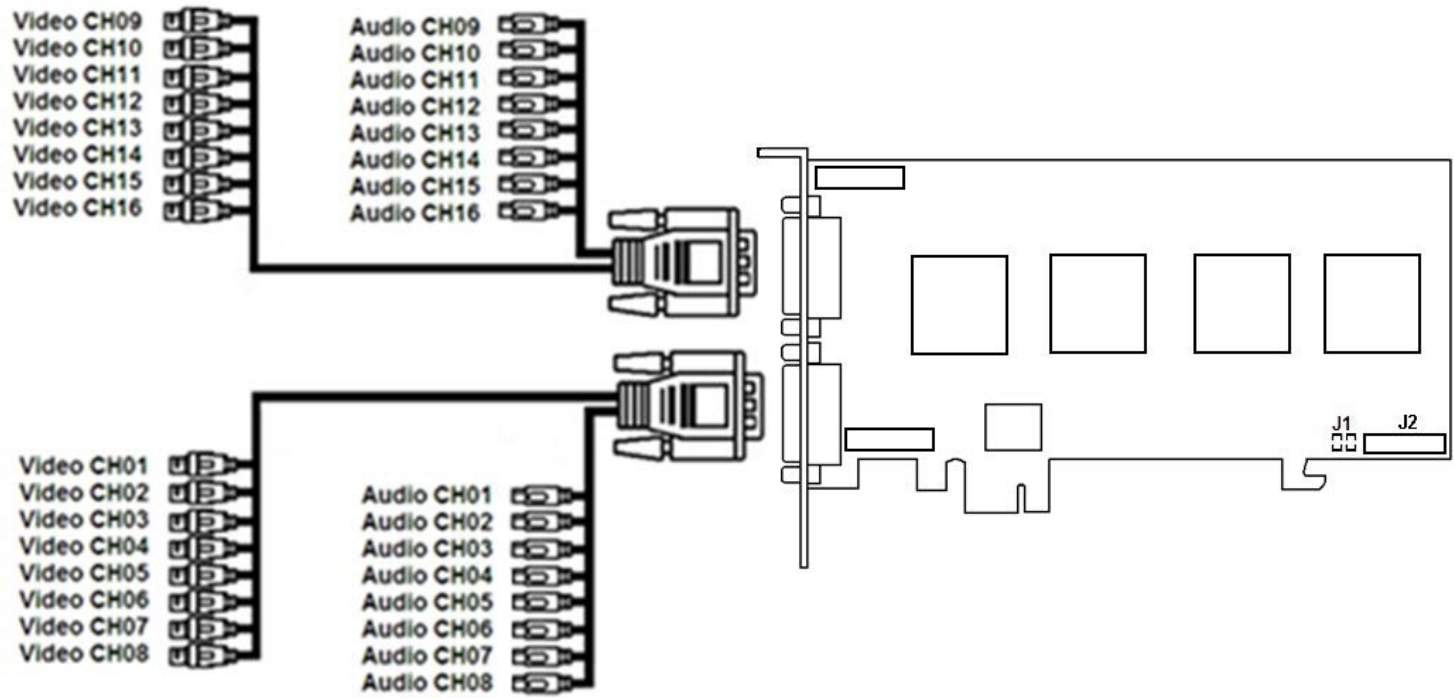

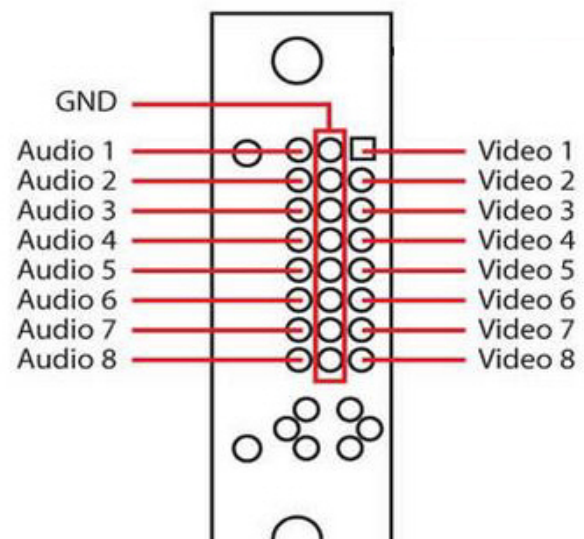
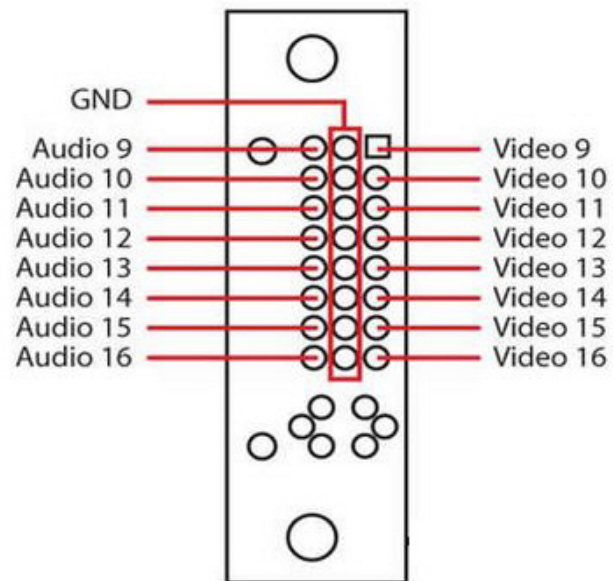



SC200Q4 (FS15) video capture card pins

SC200Q4 (FS15) video capture card has five external pins– one TRS (3,5 mm, *mini-jack*) pin and four BNC pins. Cameras are connected via BNC pin. Simultaneous connection of up to 4 cameras is possible. Sound is connected via TRS pin. The Watchdog cable is connected to the J1 pin.

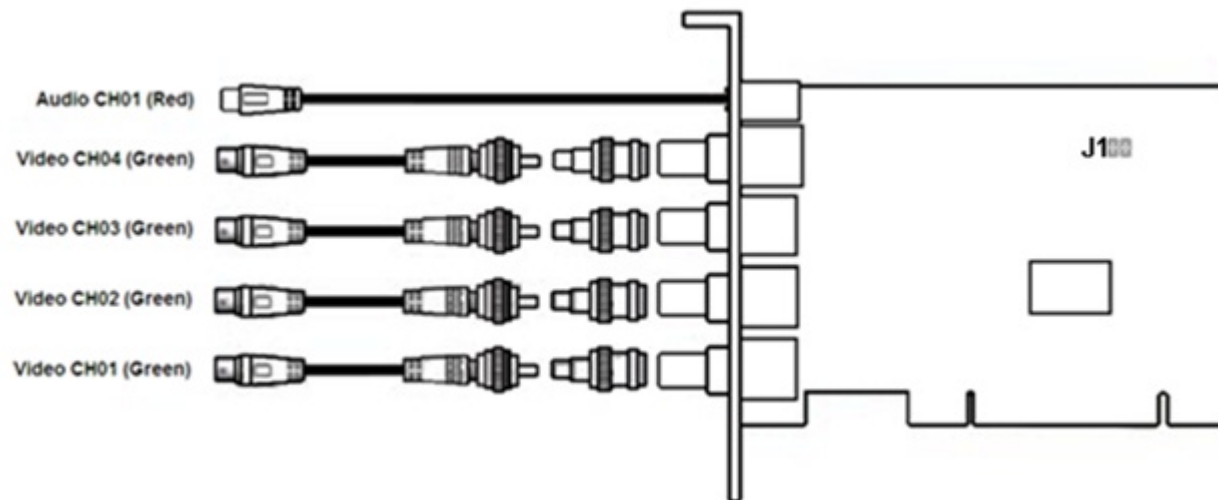

SC300D16 (FX8) video capture card pins

SC300D16 (FX8) video capture card has two external DVI-I (24+5) pins. Video and audio connection is performed with the help of DVI-I/BNC and DVI-I/RCA stubs correspondingly. Simultaneous connection of up to 8 cameras and up to 4 sound sources to one external pin of SC300D16 (FX8) video capture card is possible. The Watchdog cable is connected to the J1 pin. DI/DO card (low profile) is connected to the J2 pin.

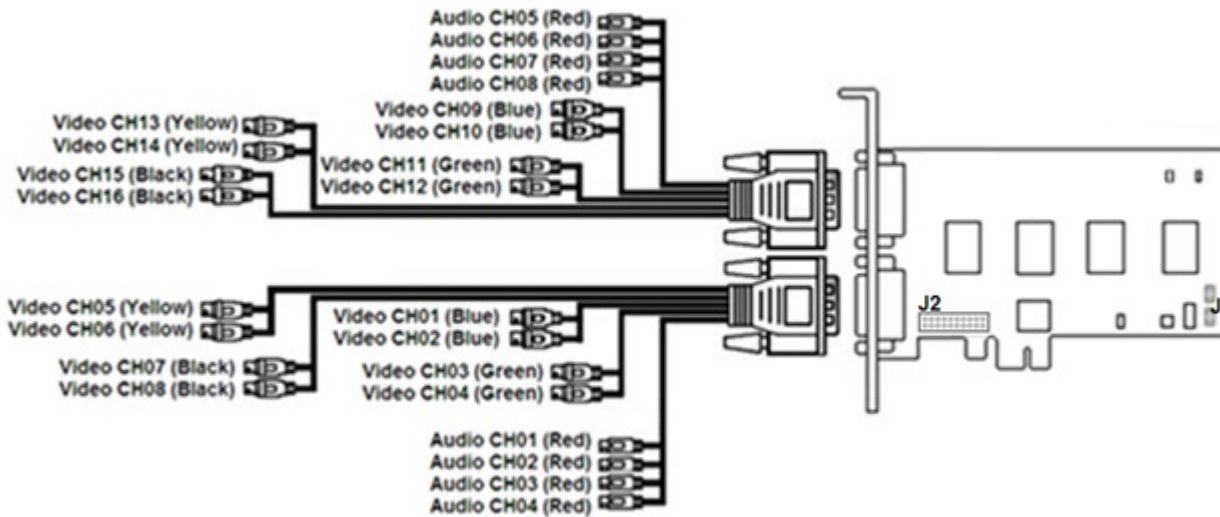

SC300Q16 (FX4) video capture card pins

SC300Q16 (FX4) video capture card has one external DVI-I (24+5) pin. Video and audio connection is performed with the help of DVI-I/BNC and DVI-I/RCA stubs correspondingly. Simultaneous connection of up to 16 cameras and up to 4 sound sources to one external pin of SC300Q16 (FX4) video capture card is possible. The Watchdog cable is connected to the J1 pin. DI/DO card (low profile) is connected to the J2 pin.

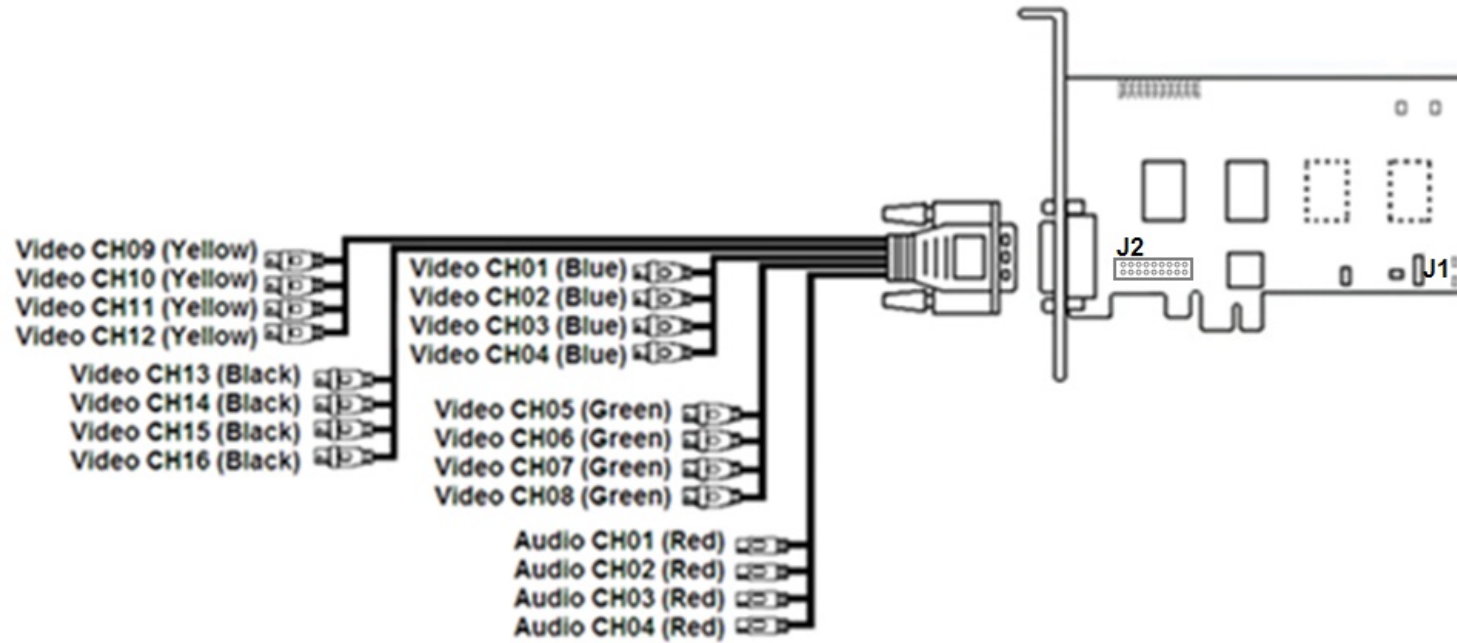

SC310N16 (FX16) video capture card pins

SC310N16 (FX16) video capture card has two external DVI-I (24 + 5) pins. Video and audio connection is performed with the help of DVI-I/BNC and DVI-I/RCA stubs correspondingly. Simultaneous connection of up to 8 cameras and up to 8 sound sources to one external pin of SC310N16 (FX16) video capture card is possible. The Watchdog cable is connected to the J1 pin. DI/DO card (low profile) is connected to the J2 pin.

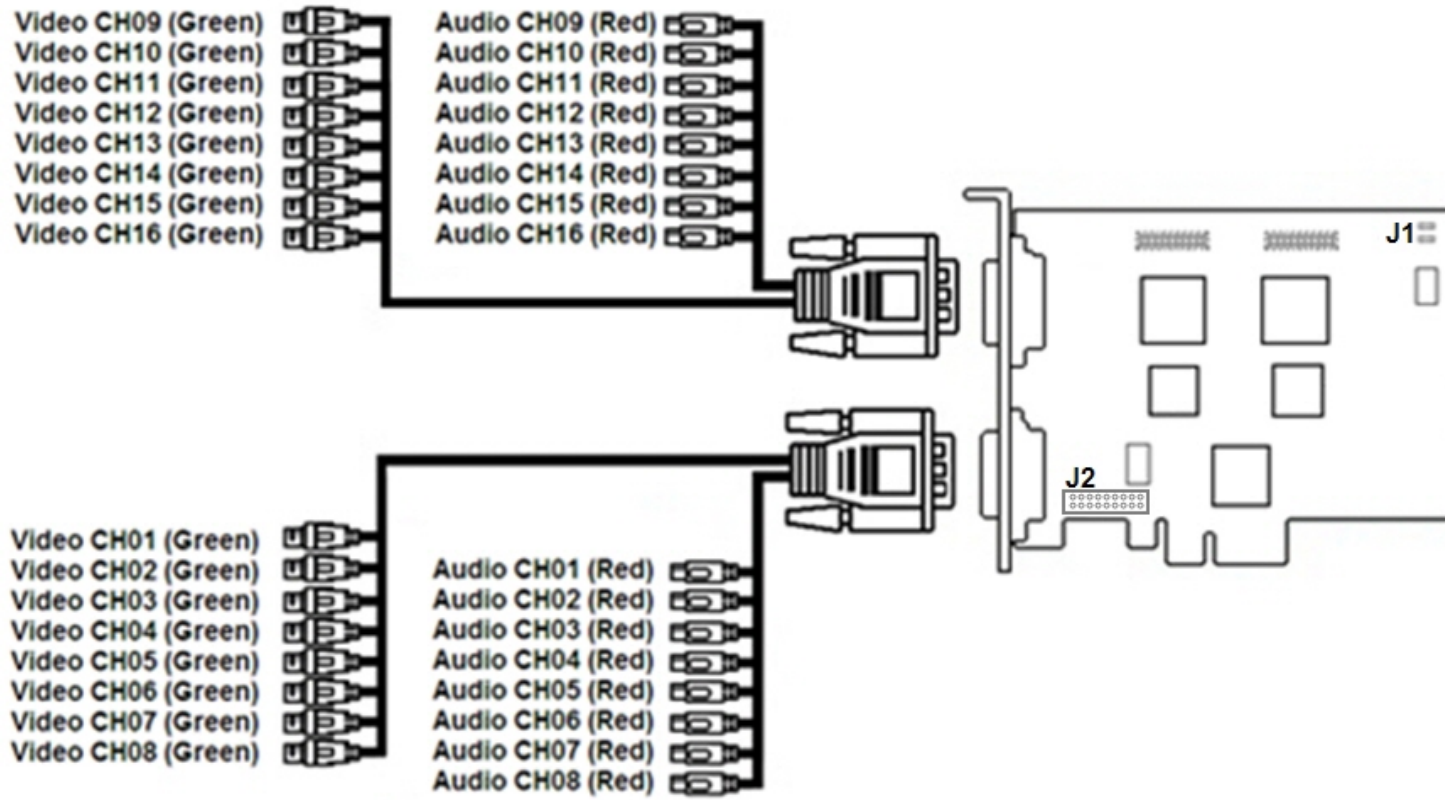

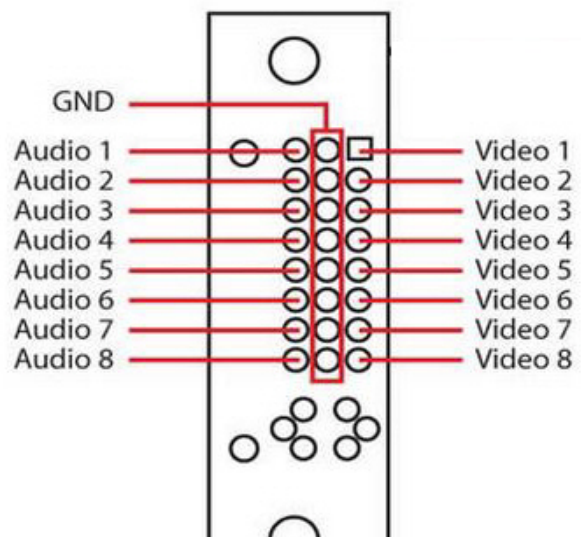
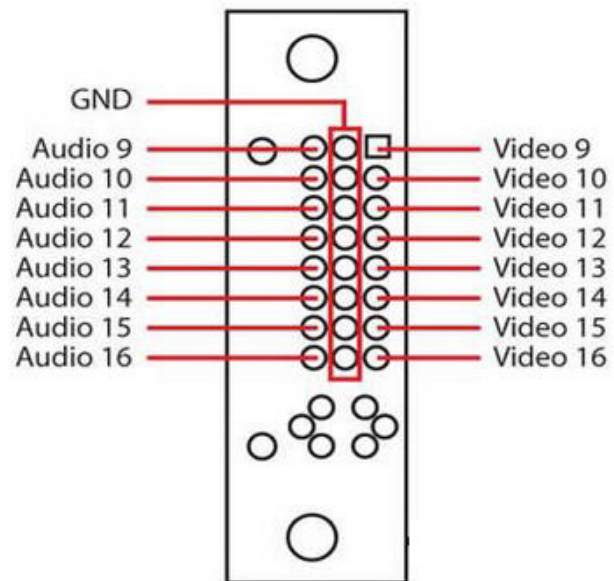



SC200Q4 Low profile (FS115) video capture card pins

SC200Q4 Low profile (FS115) video capture card has one external DVI-I pin. Video and audio connection is performed with the help of DVI-I/BNC and DVI-I/RCA stubs correspondingly. Simultaneous connection of up to 4 cameras and 1 sound source to one external pin of SC200Q4 Low profile (FS115) video capture card is possible. The Watchdog cable is connected to the J1 pin. DI/DO card (low profile) is connected to the J2 pin.

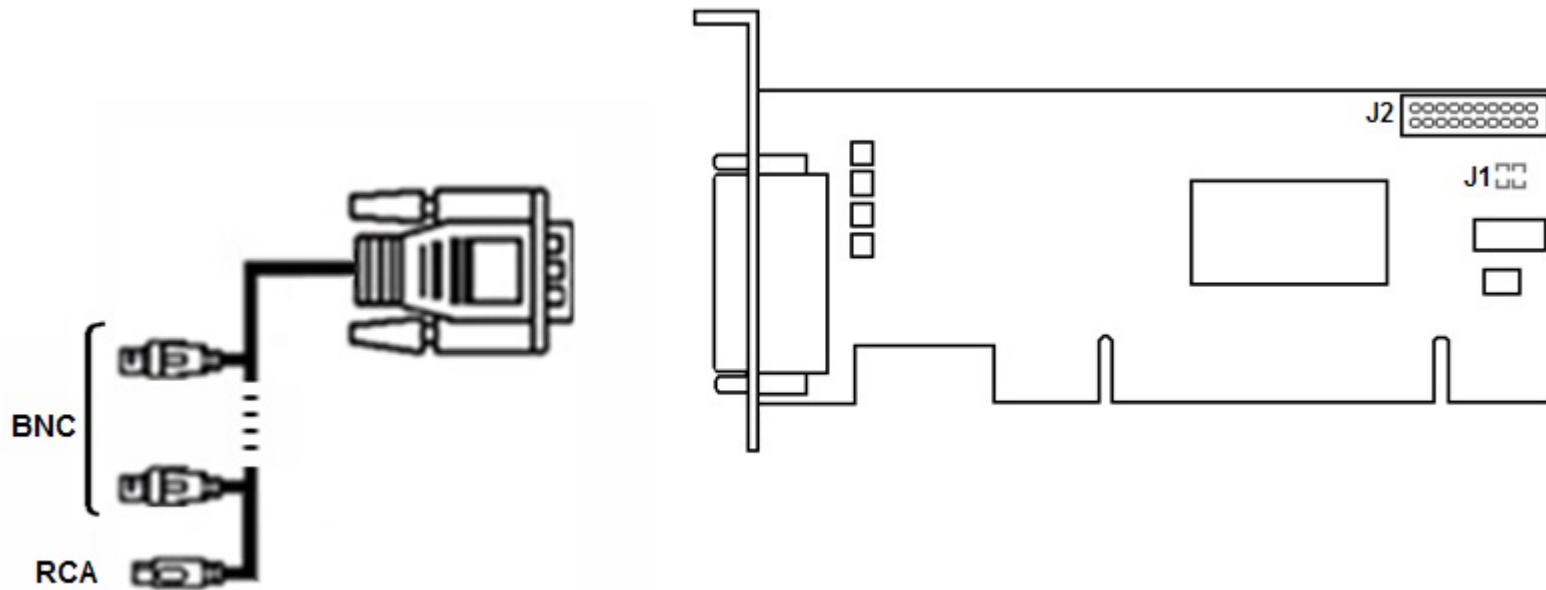

FX116 video capture card pins

FX116 video capture card has two external pins - D-SUB 25 and D-SUB 26. Simultaneous connection of up to 8 cameras and 16 sound sources to external pins of FX116 video capture card is possible. Video connection is performed with the help of D-SUB-25/BNC stub and audio connection is performed with the help of D-SUB-26/RCA stub. Watchdog cable is connected to the J1 pin.

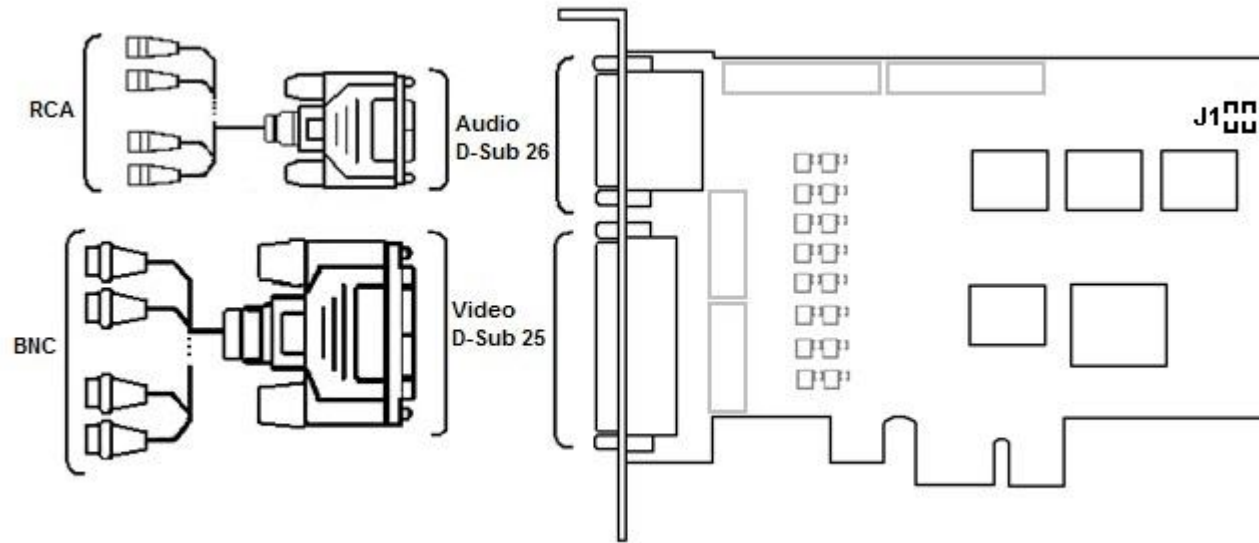

FX416 video capture card pins

FX416 video capture card has two external pins - D-SUB 25 and D-SUB 26. Simultaneous connection of up to 16 cameras and 16 sound sources to external pins of FX416 video capture card is possible. Video connection is performed with the help of D-SUB 25/BNC stub and audio connection is performed with the help of D-SUB 26/RCA stub.

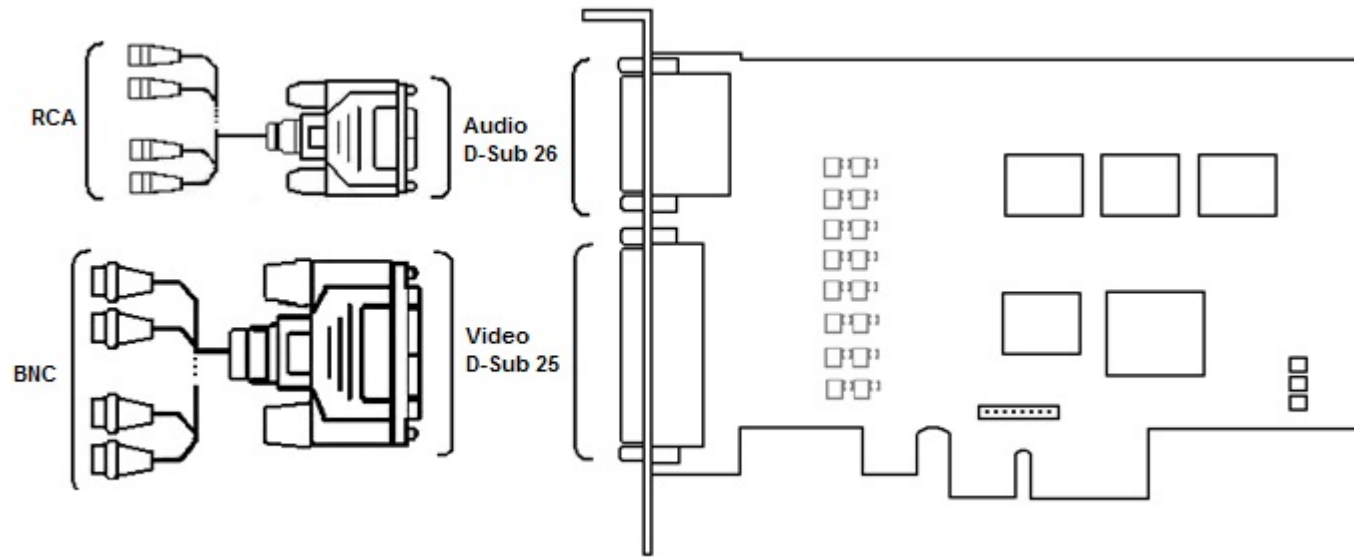

VRC6004 video capture card pins

VRC6004 video capture card has four external BNC pins. Cameras are connected with the help of BNC pin. Simultaneous connection of up to 4 cameras is possible. DI/DO card is connected to the J1 pin.

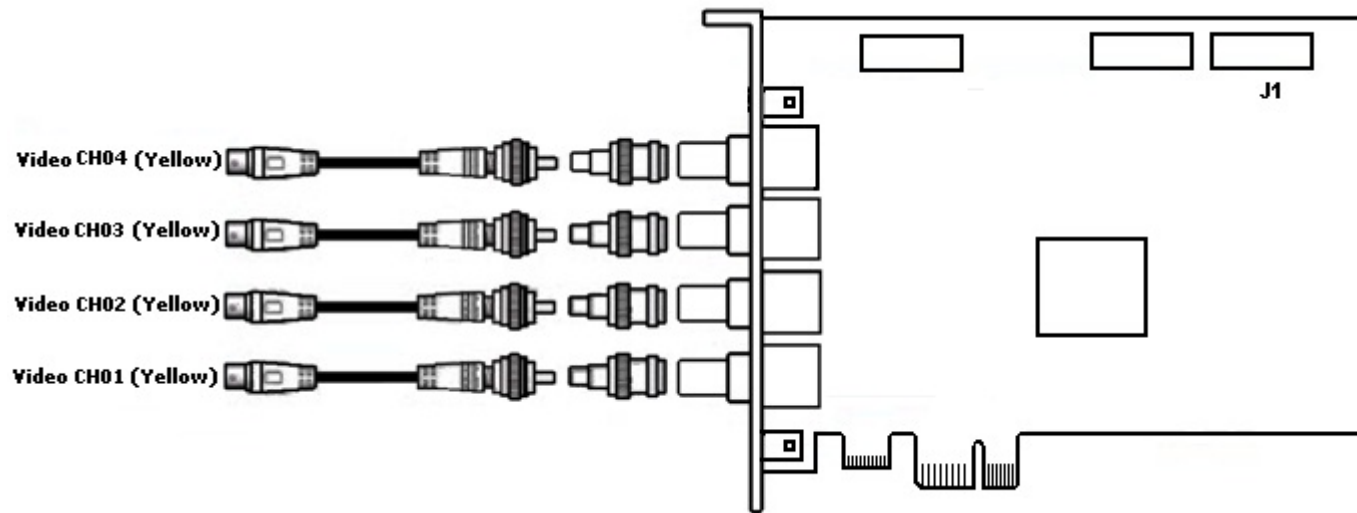

VRC6008 video capture card pins

VRC6008 video capture card has two external D-SUB-15 pins. D-SUB-15/BNC interface cable is used for simultaneous connection of up to 8 cameras and 8 audio channels to the external D-SUB-15 pin of VRC6008 video capture card. DI/DO card is connected to the J2 pin. Pin J1 corresponds to analog video out.

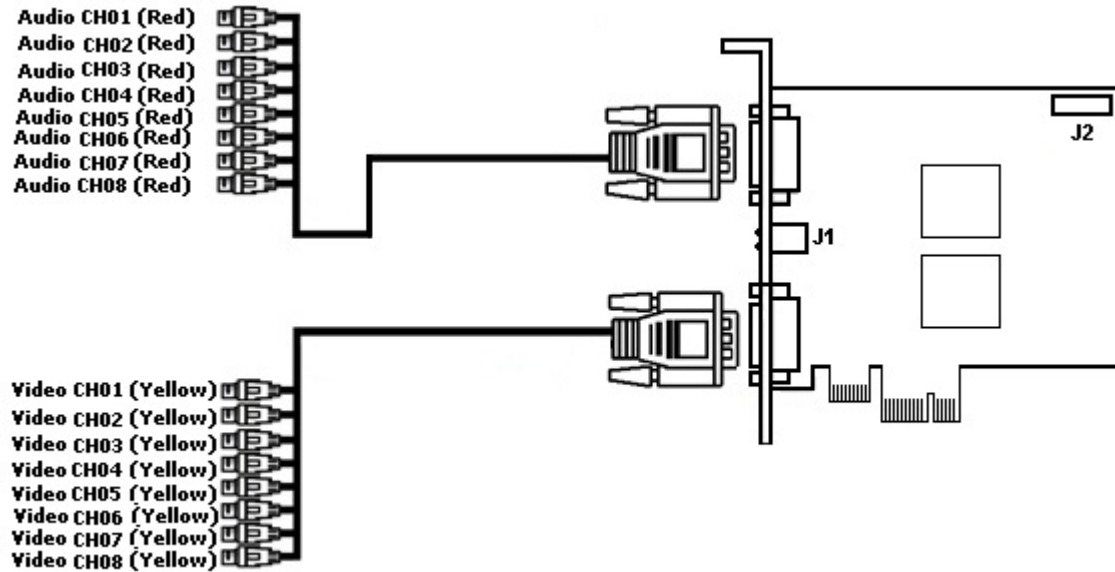

VRC6416 video capture card pins

VRC6416 video capture card has two external DVI pins. DVI /BNC interface cable is used for simultaneous connection of up to 16 cameras and 16 sound sources to external DVI pins of VRC6416 video capture card. DI/DO card is connected to the J1 pin.

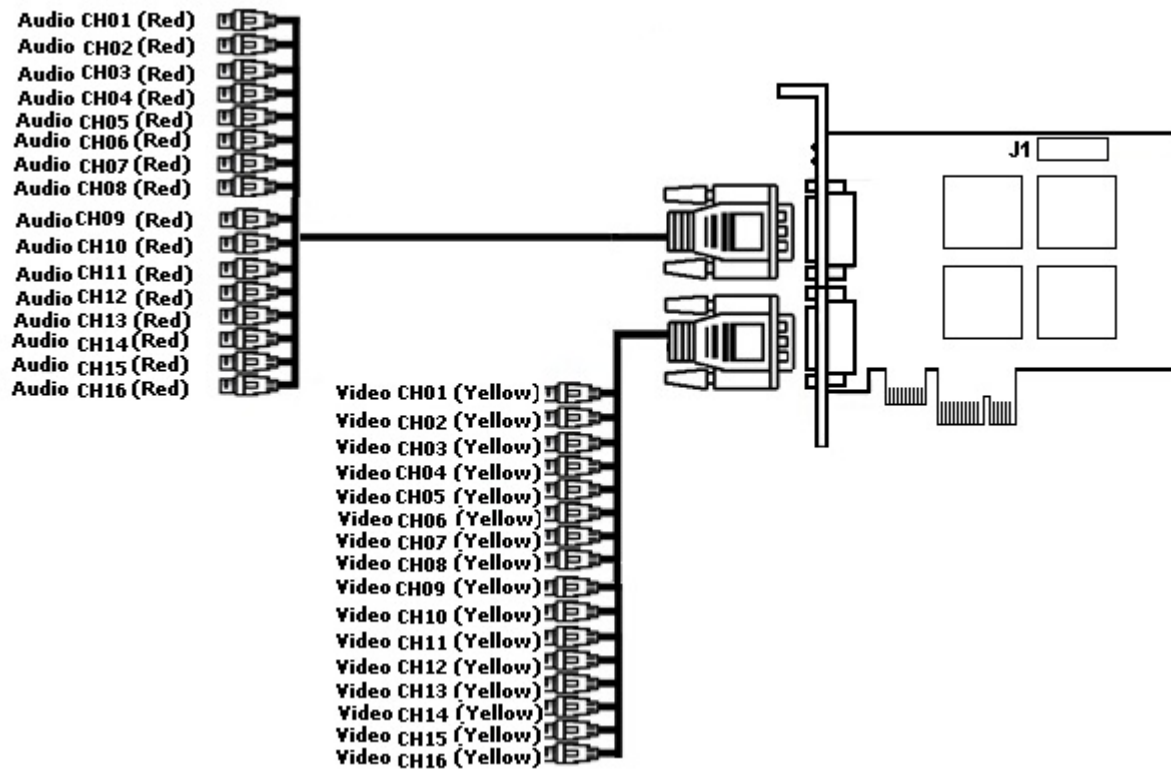

VRC7008L video capture card pins

VRC7008L video capture card has a DVI pin. DVI /BNC interface cable is used for simultaneous connection of up to 8 cameras and 8 sound sources to external DVI pin of VRC7008L video capture card. DI/DO card is connected to the J1 pin. J2 pin corresponds to analog video out.

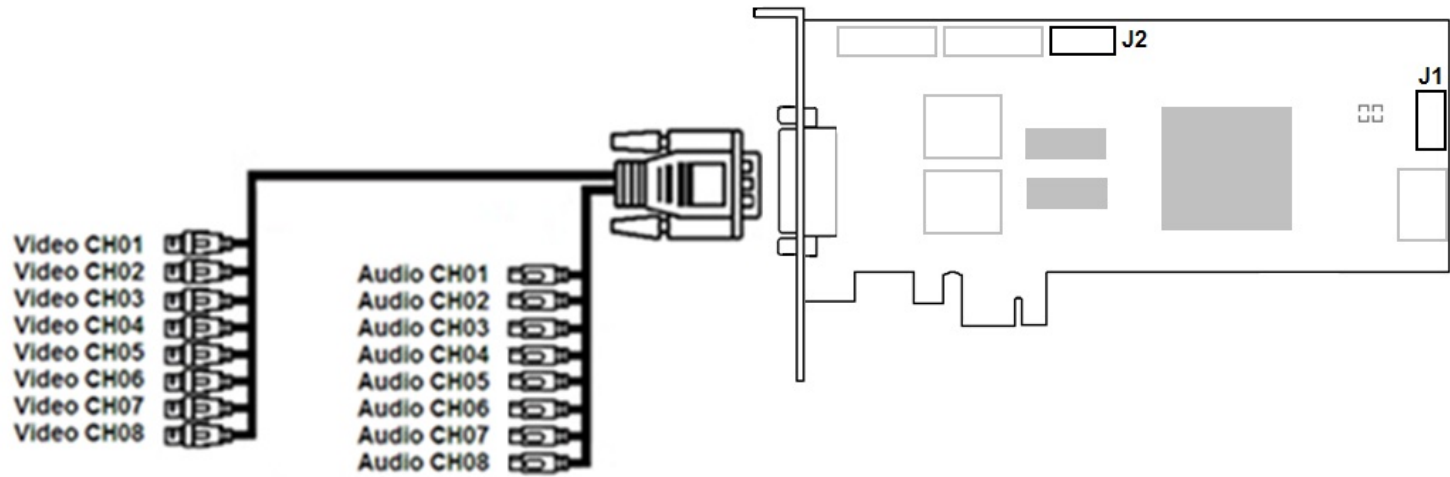

VRC6404 HD video capture card pins

VRC6404 HD video capture card has BNC pins through which cameras are connected. Up to 4 cameras can be connected. There is the 15-pin SATA (J4) power socket. D2 pin is used to connect DI/DO card.

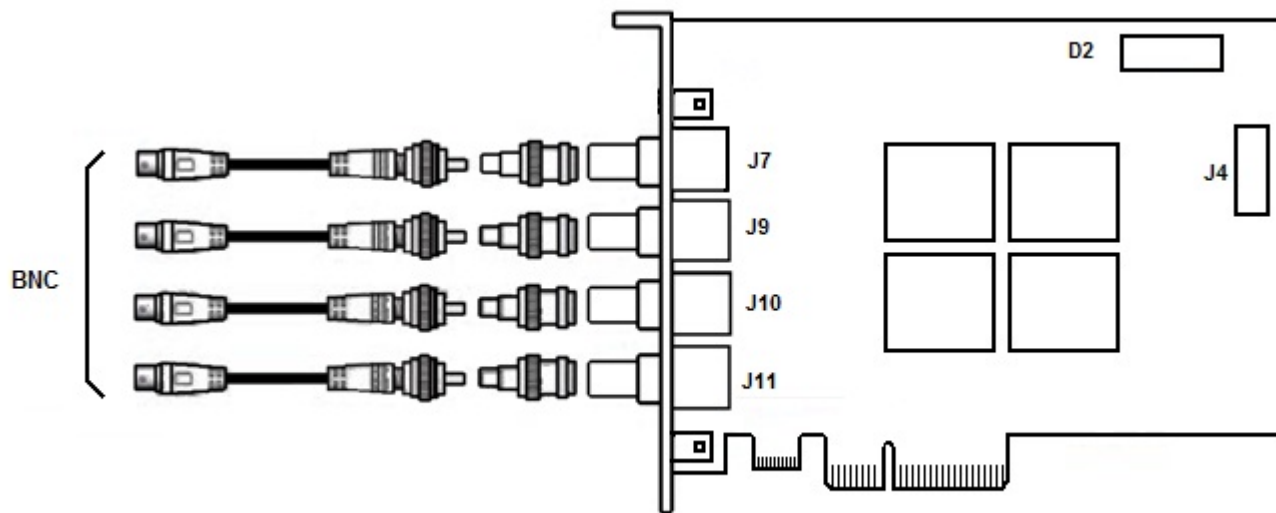

SC510N4 (FX HD4) video capture card pins

SC510N4 (FX HD4) video capture card has 4 external HDMI pins to connect video and audio devices. The Watchdog cable is connected to the J1 pin.

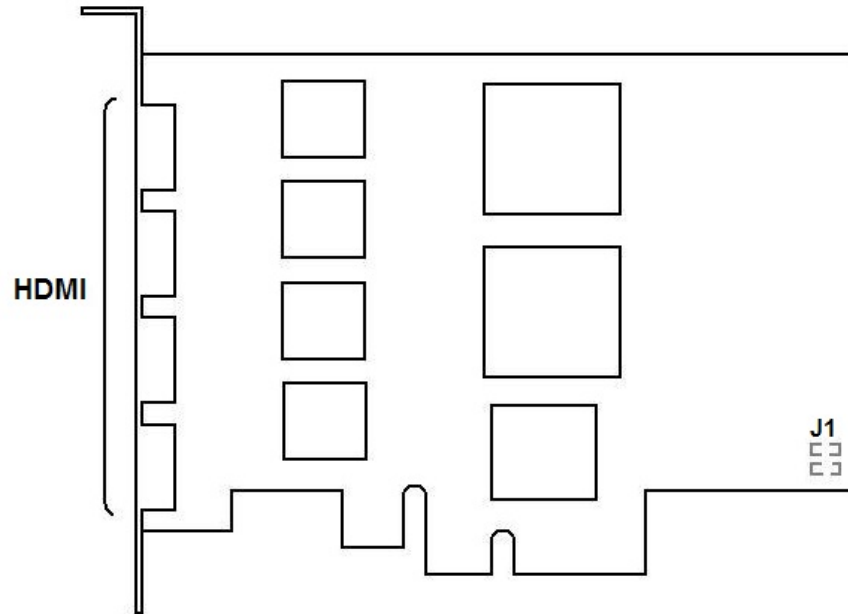

DS-4016HCI(R) video capture card pins

DS-4016HCI(R) video capture card has two external DB-15pins to connect 16 video channels and 4 audio channels. The DB15-male to BNC cable is to connect cameras and sound. Extra 12 audio channels (5 - 16) are connected to J21 pin. J1 and J2 pins are to connect audio outputs via the CD_IN-interface.

Note
At the time of writing this manual audio is not integrated into *Intellect* software

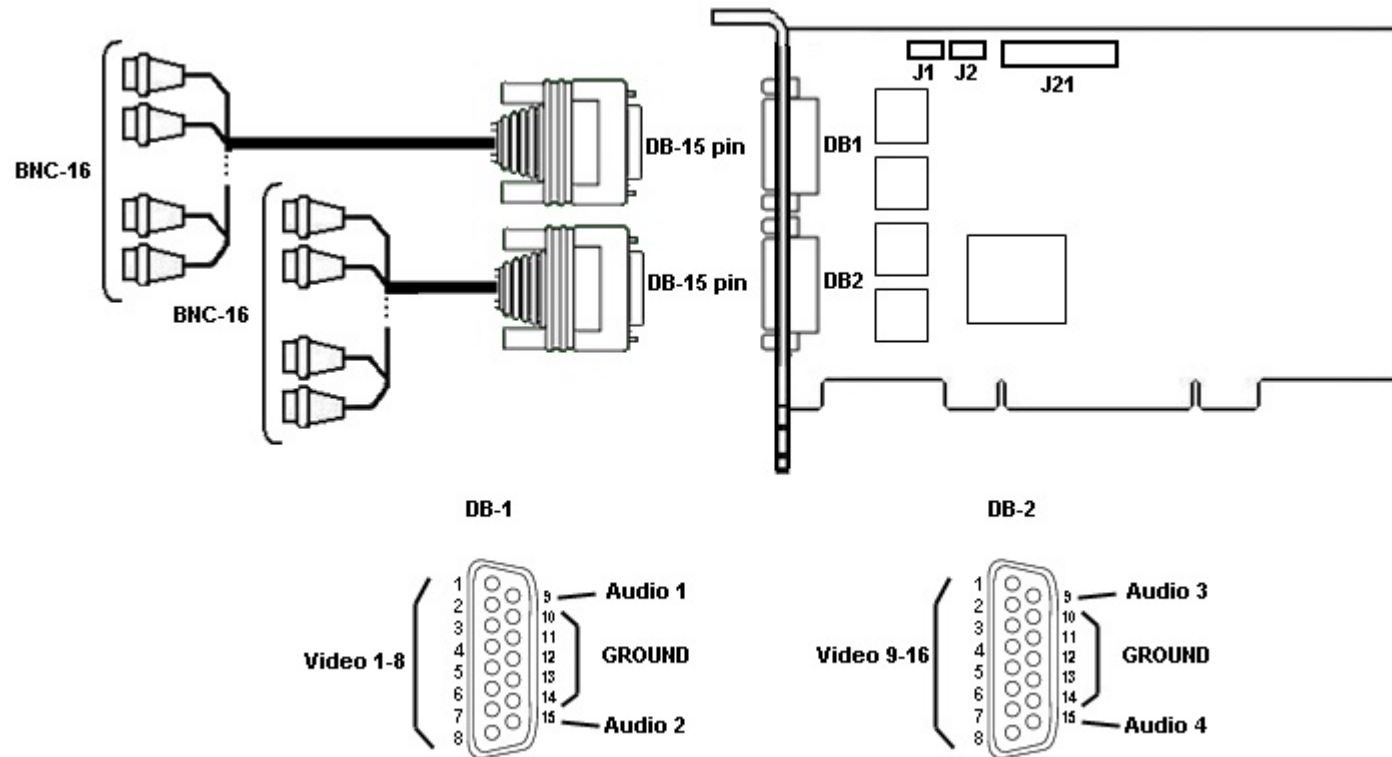

MS416 video capture card pins

The MS416 video capture card has two external pins: D-SUB-25 and D-SUB-26. Up to 16 video cameras and 16 audio sources can be simultaneously connected to the card's external sockets. Video connections are made using the D-SUB-25/BNC input. Audio connections use the D-SUB-26/RCA input. A J1 pin is used to connect the WatchDog hardware monitoring cable.

Slots 1-4 are used to connect additional sound cards. This card requires a separate slot in the case for installation, and it allows an additional 16 audio sources to be connected.

The following mapping exists between slot numbers and channel numbers:

- slot 1 - channels 1-8;
- slot 2 - channels 9-16;
- slot 3 - channels 17-24;
- slot 4 - channels 25-32.

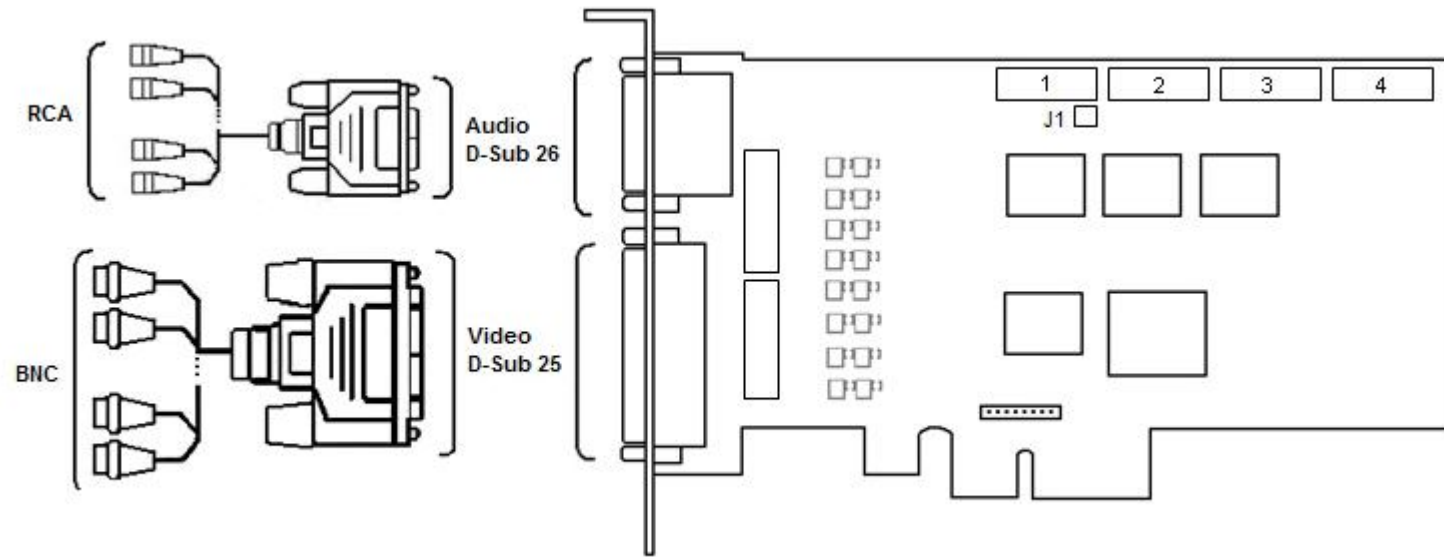

SC230N4 video capture card pins

The SC230N4 video capture card has one external DVI-I pin. Video and audio connection are made using DVI-I/BNC and DVI-I/RCA stubs correspondingly. Simultaneous connection of up to 4 cameras and 4 sound sources to one external pin of SC230N4 video capture card is possible. The Watchdog cable is connected to the J1 pin. DI/DO card (low profile) is connected to the J2 pin.

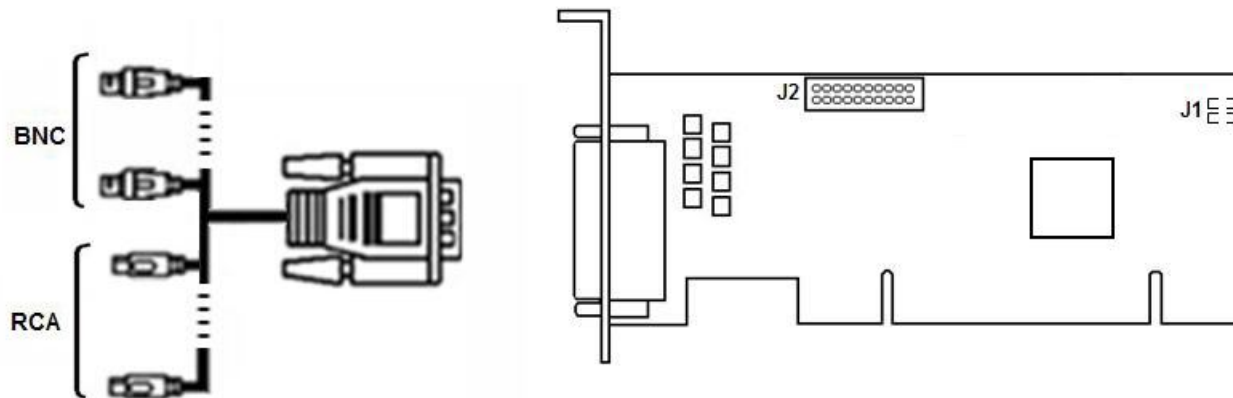

SC590N4 video capture card pins

The SC230N4 video capture card has four external SDI sockets, used to connect video cameras and audio input devices. Simultaneous connection of up to 4 cameras is possible. There are also two 3.5-jack sockets. DI/DO card is connected to the J2 pin. The Watchdog cable is connected to the J1 pin.

Note.
Both SDI sockets and analog inputs can be used for audio signal input.

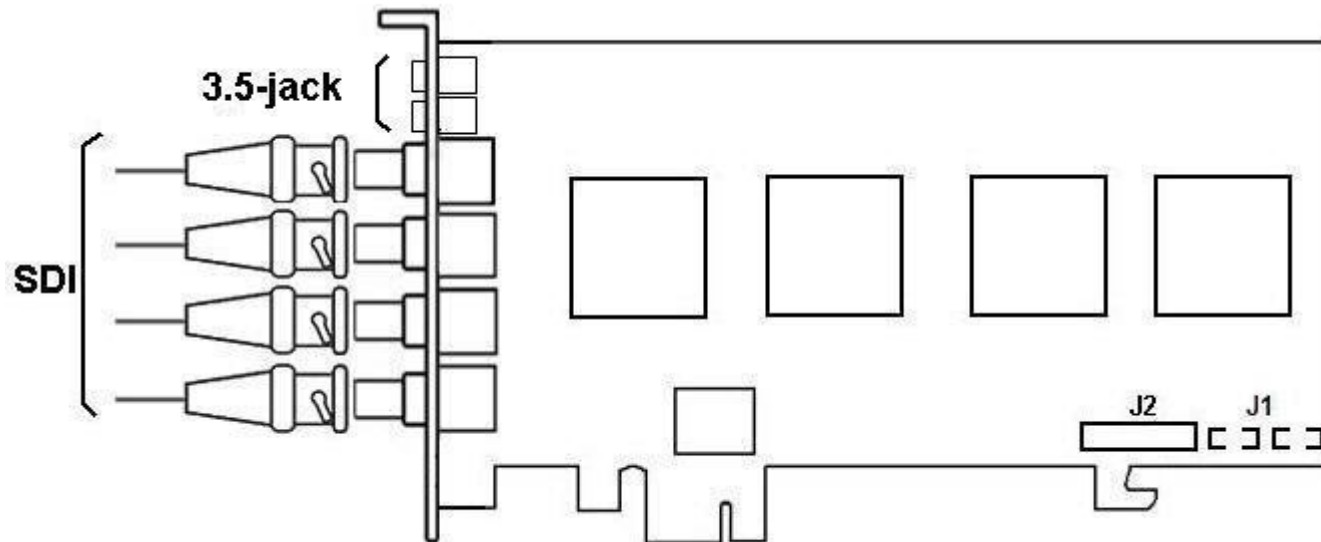

SC330Q16 video capture card pins

SC330Q16 video capture card has one external DVI-I (24+5) pin. Video and audio connection is performed with the help of DVI-I/BNC and DVI-I/RCA stubs correspondingly. Simultaneous connection of up to 16 cameras and up to 4 sound sources to one external pin of SC330Q16 video capture card is possible. The Watchdog cable is connected to the J1 pin.

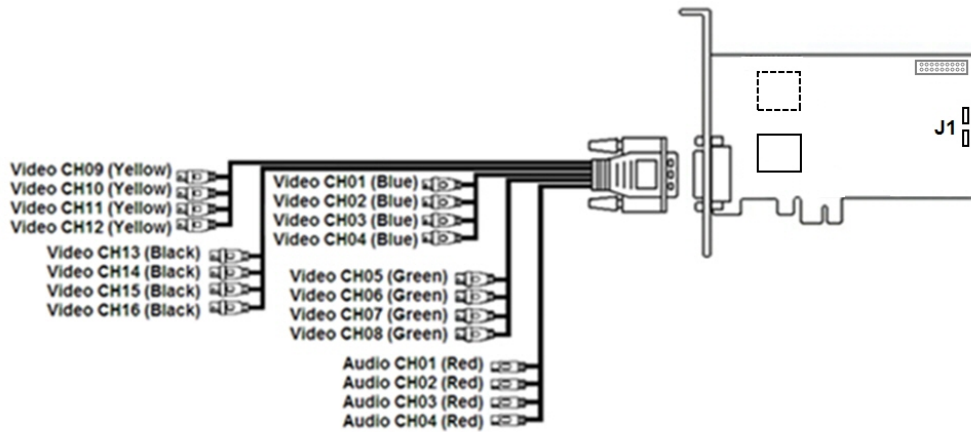

SC330D16 video capture card pins

SC330D16 video capture card has two external DVI-I (24+5) pins. Video and audio connection is performed with the help of DVI-I/BNC and DVI-I/RCA stubs correspondingly. Simultaneous connection of up to 8 cameras and up to 4 sound sources to one external pin of SC330D16 video capture card is possible. The Watchdog cable is connected to the J1 pin.

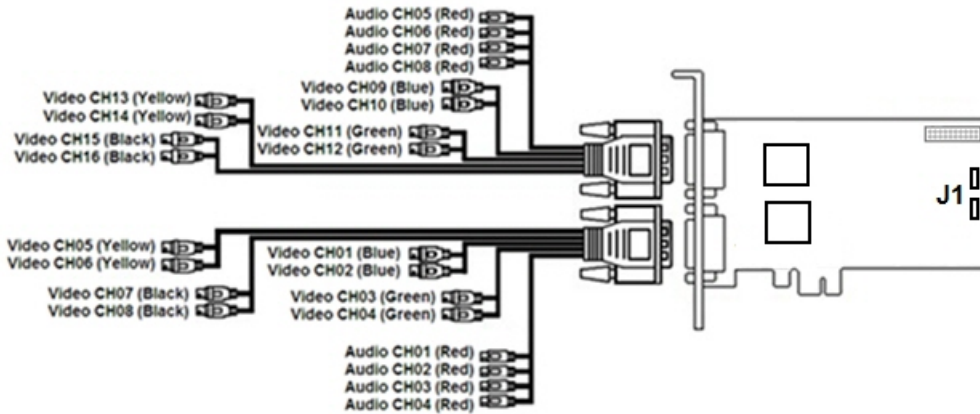

Appendix 6. Electrical and technical specifications of Sensor-Relay cards

Electrical and technical specifications of Sensor-Relay cards

Sensor-Relay cards are multichannel digital-analogue converters and transmitters of up to 4 control signals to executive devices (relays) designed to be used in video surveillance

systems built using FS-5, FS-6, FS-16 and FS-8 video capture cards.

While working with Sensor-Relay cards it is necessary to take into account the following electrical specifications:

1. Current state of a sensor.
Depending on the value of resistance between input contacts on the line, the current state of a sensor can be:
 - a. close (below 3 kilohms);
 - b. open (over 10 kilohms);
 - c. undefined (from 3 to 10 kilohms).



Note

Undefined state may be determined by the system as close or open.

2. State of a relay at the output.
State of a relay at the output is to be be **Open** for Sensor-Relay card. The following conditions are to be met:
 - a. maximum current through the open collector- 150 milliamperes;
 - b. resistance - 24 volts;
 - c. minimal resistance of connected relay- 160 ohms.

Technical specifications of Sensor-Relay cards are to be taken into account while connecting the sensors.

Parameter	4/4 Sensor-Relay cards	16/4 Sensor-Relay cards
Guard loops (sensors)	4	16
Breakdown voltage	1000 V up to 1 minute	1000 V up to 1 minute
Control output (relays)	4	4
Open collector (interface)	24, 30 ma	24, 30 ma

Electrical and technical specifications of 4/4 Sensor-Relay (low profile) cards

4/4 Sensor-Relay (low profile) card is to be used in video surveillance systems installed with SC200Q4 Low profile (FS115) / SC300Q16 (FX4) / SC300D16 (FX8) / SC310N16 (FX16) / SC230N4 / SC3B0N16 (WS216) / SC590N4 video capture cards.

Electrical and technical specifications of 4/4 Sensor-Relay (low profile) cards are given in the table:

Parameter	Sensor		Relay
Number of guard loops	4		4
Triggering time	0.1 ms		OFF -> ON: 3.0 ms ON -> OFF: 2.5 ms
Maximum value of current strength and voltage			direct current: 2 A/24 V alternating current: 1 A/120 V
Triggering level	Up to 5 V	Up to 12 V	

2.5 V - OFF	4.5 V -OFF
2.1 V - ON	2.1 V - ON

Electrical and technical specifications of MO USBIO 4x4 devices

Power is supplied to MO USBIO 4x4 device via the USB. Maximum permissible current consumed by the device is not more than 500 ma.

The MO USBIO 4x4 device has a galvanic isolation of DI/DO circuits (sensors and relays) against the USB (breakdown voltage is 1000 V up to 1 minute). Electrical and technical specifications of MO USBIO 4x4 device are given in the table.

Parameter	Relay (output circuit)	Sensor (input circuit)
Number of loops	4	4
Maximum permissible current	400 ma (in any direction)	50 ma (in any direction)
Ampere rating	-	8 ma (in any direction)
Voltage rating	-	24 V (in any direction)
Maximum permissible voltage	60 V (in any direction)	-
Embedded power supply	-	24 V

Electrical and technical specifications of SL USBIO (4x4, 16x8 and 24x4) card

Pinout of an external pin of the SL USBIO card is given in the figure.

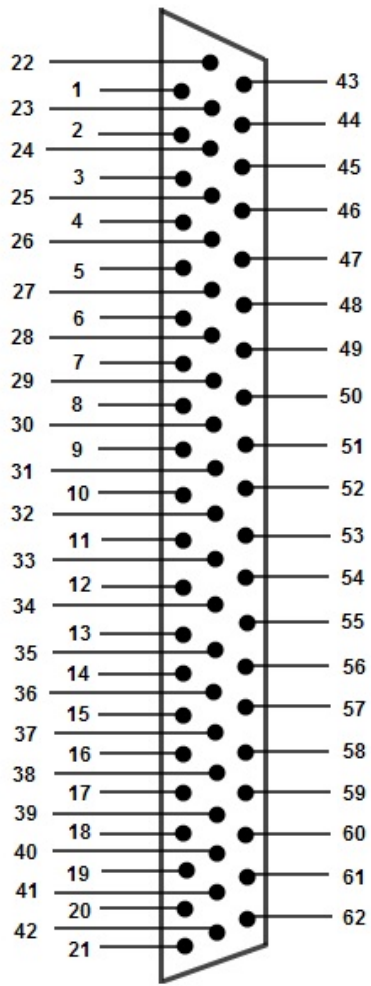

Pinout of an external pin of SL USBIO 16x8 and USBIO 24x4 cards.

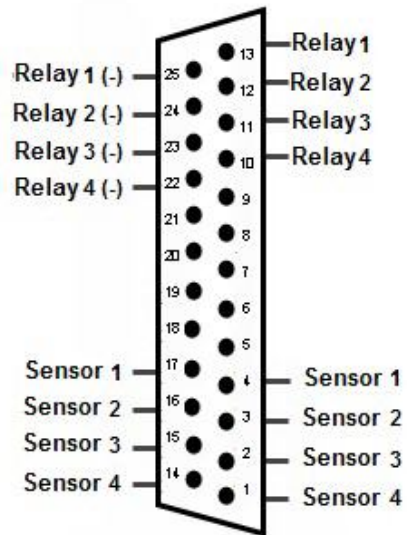

Description of channels of SL USBIO 16x8 and SL USBIO 24x4 cards is given in the table.

USBIO 16x8				USBIO 24x4			
Contact	Application	Contact	Application	Contact	Application	Contact	Application
1	Sensor 1	32	Sensor 14	1	Sensor 1	32	Sensor 14
2	Sensor 1	33	Sensor 14	2	Sensor 1	33	Sensor 14
3	Sensor 2	34	Sensor 15	3	Sensor 2	34	Sensor 15
4	Sensor 2	35	Sensor 15	4	Sensor 2	35	Sensor 15
5	Sensor 3	36	Sensor 16	5	Sensor 3	36	Sensor 16
6	Sensor 3	37	Sensor 16	6	Sensor 3	37	Sensor 16
7	Sensor 4	38	Not used	7	Sensor 4	38	Not used
8	Sensor 4	39	Not used	8	Sensor 4	39	Not used
9	Sensor 5	40	Not used	9	Sensor 5	40	Not used
10	Sensor 5	41	Relay 3 (+)	10	Sensor 5	41	Relay 3 (+)
11	Sensor 6	42	Relay 3 (-)	11	Sensor 6	42	Relay 3 (-)
12	Sensor 6	43	Not used	12	Sensor 6	43	Sensor 17
13	Sensor 7	44	Not used	13	Sensor 7	44	Sensor 17
14	Sensor 7	45	Not used	14	Sensor 7	45	Sensor 18
15	Sensor 8	46	Not used	15	Sensor 8	46	Sensor 18
16	Sensor 8	47	Not used	16	Sensor 8	47	Sensor 19
17	Not used	48	Not used	17	Not used	48	Sensor 19

18	Relay 1 (+)	49	Not used	18	Relay 1 (+)	49	Sensor 20
19	Relay 1 (-)	50	Not used	19	Relay 1 (-)	50	Sensor 20
20	Relay 2 (+)	51	Relay 5 (+)	20	Relay 2 (+)	51	Sensor 21
21	Relay 2 (-)	52	Relay 5 (-)	21	Relay 2 (-)	52	Sensor 21
22	Sensor 9	53	Relay 6 (+)	22	Sensor 9	53	Sensor 22
23	Sensor 9	54	Relay 6 (-)	23	Sensor 9	54	Sensor 22
24	Sensor 10	55	Relay 7 (+)	24	Sensor 10	55	Sensor 23
25	Sensor 10	56	Relay 7 (-)	25	Sensor 10	56	Sensor 23
26	Sensor 11	57	Relay 8 (+)	26	Sensor 11	57	Sensor 24
27	Sensor 11	58	Relay 8 (-)	27	Sensor 11	58	Sensor 24
28	Sensor 12	59	Not used	28	Sensor 12	59	Not used
29	Sensor 12	60	Not used	29	Sensor 12	60	Not used
30	Sensor 13	61	Relay 4 (+)	30	Sensor 13	61	Relay 4 (+)
31	Sensor 13	62	Relay 4 (-)	31	Sensor 13	62	Relay 4 (-)

Electrical and technical specifications of SL USBIO card are given in the table.

Parameter	Characteristic
Polling interval for all alarm inputs	250 ms for all contacts. Not configured.
Galvanic isolation of input/output	1000 V
Interface connection to PC	USB 2.0 up to 5 m
Alarm contacts	<ul style="list-style-type: none"> • Maximum current – 0.5 A • Voltage – 100 V • Power – 10 W
Relay contacts	<ul style="list-style-type: none"> • Permissible voltage - up to 80 V • Minimum triggering voltage - 1.0 V • Minimum triggering current - 5 ma
Real-time clock for event logging	Yes
ROM	For 1000 alarm events
Power supply	Using USB port or PSU, voltage - 9-50 V, consumption - 500 ma