



## Intellect Software Integration Guide (HTTP API, IIDK, ActiveX)

Last update 02/09/2019

## Table of contents

<b>1</b>	<b>Intellect Software Integration Guide. Introduction .....</b>	<b>9</b>
<b>2</b>	<b>Hardware and Software Module Integration.....</b>	<b>10</b>
2.1	Integrating hardware and software modules with Intellect.....	10
2.1.1	General information on hardware and software modules integrating.....	10
2.1.2	Editing the DBI file.....	10
2.1.2.1	Adding Objects to Intellect.dbi.....	11
2.1.2.2	Using the ddi.exe Tool to Work with DBI files.....	13
2.1.3	Editing the DDI file .....	14
2.1.3.1	Adding Object Information to intellect.ddi .....	15
2.1.3.2	Using the ddi.exe Tool to Work with DDI files.....	16
2.1.4	Additional Functionality of the ddi.exe Utility.....	18
2.1.5	Creating MDL files .....	20
2.1.5.1	MDL File Creation Wizard .....	27
2.1.6	Creating RUN files .....	28
2.1.7	Creating and Configuring Integrated Objects (Modules) in Intellect .....	29
2.2	Intellect Integration Developer Kit (IIDK) .....	30
2.2.1	General Information on IIDK.....	30
2.2.1.1	Purpose of the IIDK .....	30
2.2.1.2	Developer Requirements .....	30
2.2.1.3	IIDK Components .....	30
2.2.2	Connecting to Intellect .....	31
2.2.2.1	Connection Parameters.....	31
2.2.2.2	IIDK Interface Object.....	31
2.2.2.3	Configuring passing events throung IIDK Interface object .....	32
2.2.2.4	Features of ATMs integration. ATM object .....	33
2.2.3	IIDK Functions .....	33
2.2.3.1	Connect .....	33
2.2.3.2	SendMsg .....	34
2.2.3.3	Disconnect.....	35
2.2.3.4	Other functions .....	36
2.2.3.4.1	Connect3 .....	36
2.2.3.4.2	SendReactToCore .....	36
2.2.3.4.3	IsConnected .....	37

2.2.3.4.4	Connect4 .....	37
2.2.3.4.5	SendData4 .....	37
2.2.3.4.6	SendFile .....	38
2.2.3.4.7	GetMsg .....	38
2.2.4	Sent Message Syntax .....	38
2.2.4.1	Message Syntax .....	38
2.2.4.2	Message Syntax (port 900) .....	39
2.2.4.3	Using the Event and React classes .....	40
2.2.5	Examples of Managing System Objects .....	40
2.2.5.1	Adding, Updating, and Deleting System Objects .....	40
2.2.5.1.1	Adding a User to a Department .....	41
2.2.5.1.2	Adding and Deleting a Video Capture Card .....	41
2.2.5.2	Working with the System in the Multiuser Mode .....	41
2.2.5.3	Determining Computers Where Intellect was Unloaded (via Port 1030) .....	41
2.2.5.4	Redirecting Video Cameras to the Monitor .....	41
2.2.5.5	Obtaining Object Parameters (via Port 1030 ) GET_CONFIG .....	42
2.2.5.6	Obtaining Information on Object States GET_STATE and GET_LIST .....	43
2.2.5.7	Showing Information Messages. SET_STATE .....	43
2.2.5.8	Live and archived video .....	43
2.2.5.9	Telemetry control via IIDK .....	44
2.2.5.10	Map layer operations .....	44
2.2.5.11	Obtaining info on core queues with GET_QUEUE_INFO command .....	45
<b>3</b>	<b>CamMonitor.ocx ActiveX Control .....</b>	<b>46</b>
3.1	General description of CamMonitor.ocx component of ActiveX .....	46
3.1.1	General information .....	46
3.1.2	Requirements to developers .....	46
3.2	How to install CamMonitor.ocx .....	46
3.3	CamMonitor.ocx parameters .....	47
3.3.1	CamMenuOptions .....	47
3.3.2	CamMenuProcessingOptions .....	47
3.3.3	CamButtonsOptions .....	48
3.3.4	MainPanelOptions .....	48
3.3.5	KeysOptions .....	49
3.3.6	OverlayMode .....	49
3.3.7	How to use parameters .....	49

3.4	CamMonitor.ocx methods .....	50
3.4.1	Connect .....	50
3.4.2	ShowCam .....	50
3.4.3	DoReactMonitor .....	50
3.4.4	RemoveAllCams .....	51
3.4.5	IsConnected .....	51
3.4.6	GetCurlp.....	51
3.4.7	SendRawMessage .....	51
3.4.8	Disconnect.....	52
3.4.9	SetCallBackOptions .....	52
3.4.10	SetParam.....	52
3.5	CamMonitor.ocx events .....	52
<b>4</b>	<b>Intellect HTTP API .....</b>	<b>54</b>
4.1	General information on HTTP API .....	54
4.2	Getting events .....	54
4.2.1	Getting events of video subsystem in blocks .....	55
4.3	Maps.....	57
4.3.1	Getting the list of maps.....	57
4.3.2	Information on one map.....	57
4.3.3	The list of layers for specific map.....	58
4.3.4	Information on a specific layer.....	58
4.3.5	Layer background .....	59
4.3.6	The list of point on the layer.....	59
4.3.7	Information on a specific point on the layer .....	61
4.4	Object classes.....	61
4.4.1	The list of object classes on the server .....	61
4.4.2	Specific object class .....	62
4.4.3	The list of states for a specific object class.....	62
4.4.4	Information on a specific state.....	62
4.4.5	Getting the icon for a specific state.....	63
4.4.6	The list of events for a specific object class.....	63
4.5	Objects.....	64
4.5.1	Getting list of objects .....	64
4.5.2	Information on a specific object .....	67
4.5.3	State of a specific object.....	67

4.5.4	The list of available actions with the object in a specific state .....	68
4.6	Product version .....	68
4.7	Sending commands to server.....	68
4.8	Macros .....	69
4.8.1	Getting the list of macros .....	69
4.8.2	Getting parameters of macros .....	69
4.8.3	Macros execution on server request .....	69
4.9	Video .....	70
4.9.1	Configuration request.....	70
4.9.2	Video query.....	71
4.9.3	Format of main stream .....	71
4.9.3.1	Managing records.....	73
4.9.3.2	Arming and disarming the camera.....	73
4.9.4	Thumbnails request.....	73
4.9.4.1	Method 1.....	73
4.9.4.2	Method 2.....	74
4.9.5	Authorization by token .....	74
4.10	PTZ control.....	75
4.11	Using the archive.....	76
4.11.1	Getting list of records - "arc.intervals" .....	76
4.11.2	Getting one frame from archive - "arc.frame" .....	77
4.11.2.1	1st way .....	77
4.11.2.2	2nd way .....	78
4.11.3	Getting video from archive - "arc.play" .....	78
4.11.4	Getting list of records (the second way) .....	78
4.12	Notification.....	81
4.12.1	Subscribing.....	81
4.12.2	Subscription cancellation.....	82
4.12.3	APN message format.....	82
4.13	Sound.....	82
4.13.1	Getting live sound .....	82
4.13.2	Playing sound from archive.....	84
4.13.3	Sending live sound.....	84
4.14	Commands used for ECHD integration .....	84
4.14.1	Archive downloading.....	85

4.14.2	Archive export .....	85
4.14.2.1	Creating archive export request.....	85
4.14.2.2	Getting export status .....	86
4.14.2.3	Deleting archive .....	86
4.14.3	List of cameras and their parameters.....	87
4.14.3.1	GetCameras.....	87
4.14.3.2	GetDeviceInfo .....	87
4.14.4	Ranges of available archive recordings .....	88
4.14.5	Video surveillance device features management .....	89
4.14.5.1	Discrete motion.....	89
4.14.5.2	Relative motion.....	89
4.14.5.3	Setting position of video surveillance device.....	90
4.14.5.4	Getting position of video surveillance device .....	90
4.14.5.5	Focusing .....	90
4.14.5.6	Iris control .....	91
4.14.5.7	Night mode.....	91
4.14.5.8	Backlight.....	92
4.14.5.9	BW mode .....	92
4.14.6	Working with video streams .....	92
4.14.6.1	GetLiveUrl(Camerald) .....	93
4.14.6.2	GetArclliveURL(Camerald, FromDatetime, toDatetime).....	93
4.15	Sending reactions or events to Intellect with HTTP API .....	93
4.15.1	Sending HTTP API commands using curl tool .....	93
4.15.2	Sending reactions and events to Intellect using HTTP request. Request for archive frame .....	93
4.15.3	Sending reactions to Intellect via HttpListener.....	94
4.16	Configuring the Technoserv integration.....	94
4.16.1	Filling in the ApiBgConfig.xml configuration file.....	95
4.16.2	Examples of commands to work with the Technoserv integration .....	97
4.16.2.1	Getting a list of cameras .....	97
4.16.2.2	Get a list of subscriptions .....	98
4.16.2.3	Create subscription.....	98
4.16.2.4	Delete subscription .....	99
4.16.2.5	Delete all subscriptions .....	99
<b>5</b>	<b>Intellect HTTP-Server.....</b>	<b>100</b>
5.1	General information on HTTP-Server .....	100

5.2	Configuring the HTTP-Server object .....	100
5.3	HTTP-Server requests .....	101
6	<b>Intellect software Integration Guide. Postscript .....</b>	<b>102</b>
7	<b>APPENDIX 1. DDI file structure.....</b>	<b>103</b>
8	<b>APPENDIX 2. NissObjectDLLExt and CoreInterface class declarations .....</b>	<b>105</b>
8.1	CoreInterface.....	106
8.2	NissObjectDLLExt.....	108

Download DEMO module



# 1 Intellect Software Integration Guide. Introduction

This document provides the information needed for Intellect software interaction with external systems. Intellect software has the following interfaces for this:

1. IIDK Interface: intended for integration of functional modules that perform the following tasks:
  - a. Adding new security hardware to the system.
  - b. Implementing new service functions (security hardware management).

The module integration steps are explained using a demonstration module, DEMO, as an example (its source code may be found in an appendix to the documentation).

DEMO module can also be downloaded in section [Intellect Software Integration Guide \(HTTP API, IIDK, ActiveX\)](#) of the online documentation.

2. CamMonitor.ocx ActiveX Control: the component is similar in every way to the Video monitor interface object. It allows you to manage cameras, view the archive, etc.
3. HTTP API: the program interface allows to send commands and receive data from Intellect software by HTTP requests.

## 2 Hardware and Software Module Integration

### 2.1 Integrating hardware and software modules with Intellect

#### 2.1.1 General information on hardware and software modules integrating

To integrate a hardware and software (functional) module into Intellect, perform the following steps:

1. Edit the DBI file.
2. Edit the DDI file.
3. Prepare a module.mdl file, where “module” is the name of the module to be integrated (this file is a transformed DLL file).
4. Prepare an executable file, module.run, where “module” is the name of the module to be integrated (this file is a transformed EXE file).
5. Copy module.mdl and module.run to the *Intellect\Modules* folder.

Figure below shows a diagram of interaction between a functional module and the system core.

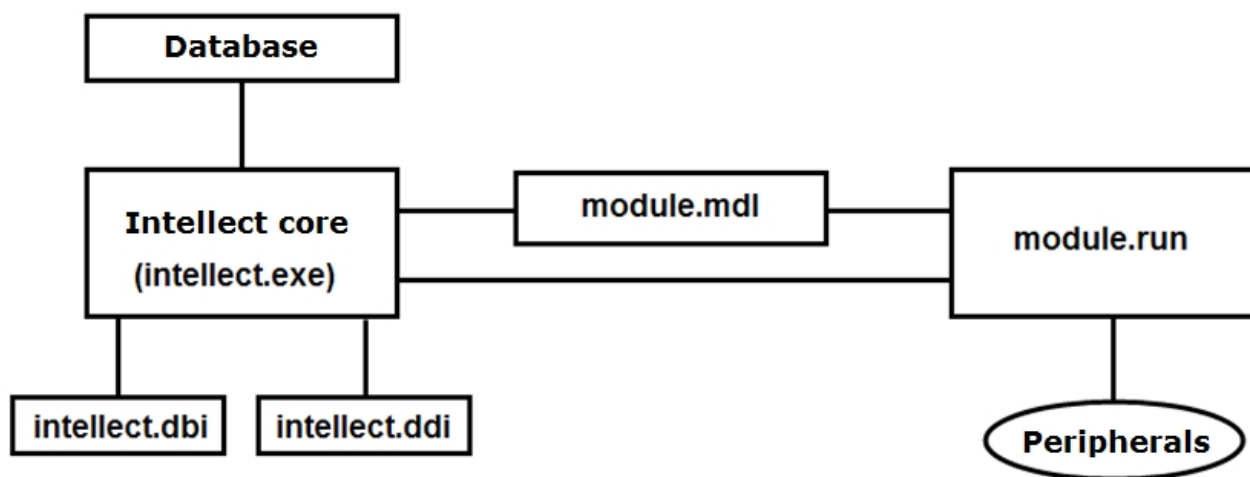

The DBI and DDI files contain information on the integrated functional modules (objects); this information is needed for the operation of the system core. The DBI file describes the structure of Intellect's configuration database. The DDI file describes the objects and their parameters. When an object is integrated, the name of the object, its parameters, and the related system events and reactions are added to these files.

The MDL file is used for working with one type of objects: it allows you to create, delete, and modify object parameters (during setup or operation), save them in the database, and perform several special operations. The MDL file also ensures that the parameters of created/modified objects are sent to the executable file (the RUN file), and contains the configurations of the object setup panels.

The executable RUN file interacts with devices, passes event information to the core, and enables device management. In this document, we describe the steps for module integration by using the *DEMO* module, which emulates working with virtual hardware. This module includes devices with unique addresses for accessing and polling these devices. Thus the system includes a configuration consisting of 2 main objects: a parent object, **DEMO**, with the **COM port** parameter, and a child object, **DEMO\_DEVICE**, with the **Address** parameter. The system allows you to perform a number of actions with devices and to pass all their events to the system core.

#### 2.1.2 Editing the DBI file

The intellect.dbi file contains the master list of the tables and fields of the database. We recommend that you create your own database template in a separate file and name it intellect.xxx.dbi, where xxx is a unique sequence in the filename. By using a separate file, you avoid double inclusion of the tables and fields after an update to the Intellect software package. On startup of the software package, the DBI files are merged.

### 2.1.2.1 Adding Objects to Intellect.dbi

Objects are added to intellect.dbi as follows:

1. Go to *Intellect's* root folder and open the intellect.dbi file with a text editor.
2. Add the objects to intellect.dbi. For each object, you must supply its name (used for identification) in brackets and then declare its fields. Below is the field declaration syntax:

**<Field name>, <Type> [, <Size>]**

 **Note.**

The **Size** may be set for fields of the CHAR type only.

The table below shows the fields mandatory for all objects in *Intellect*.

Field	Description
id	Unique object ID
name	Object name
parent_id	Parent object ID
flags	Parameter for internal system use

 **Attention!**

The flags field may not be used by external applications.

The following table describes the allowed data types.

Data type	Description
BIT	Used for creating a flag field that takes a logical value, Yes or No.
CHAR	Used for fields that contain short character sequences.
DATETIME	Used for fields that contain dates and times. The date format is YYYY-MM-DD and the time format is HH:MM:SS.XXX.
DOUBLE	Used for fields that contain floating-point numbers.
INTEGER	Used for fields that contain integer numbers.
TEXT	Used for fields that contain text strings.

Beside the mandatory fields, the objects of the DEMO module contain the following fields:

- a. **port** – COM port address;
- b. **address** – device address.

Figure below shows sample object additions and field declarations in intellect.dbi.

```
[OBJ_DEMO]
id, CHAR, 16
name, CHAR, 60
parent_id, CHAR, 16
flags, INTEGER
port, CHAR, 5

[OBJ_DEMO_DEVICE]
id, CHAR, 16
name, CHAR, 60
parent_id, CHAR, 16
flags, INTEGER
address, INTEGER
```

3. Save the changes to the intellect.dbi file.
4. Go to Intellect's root folder and run the idb.exe utility.

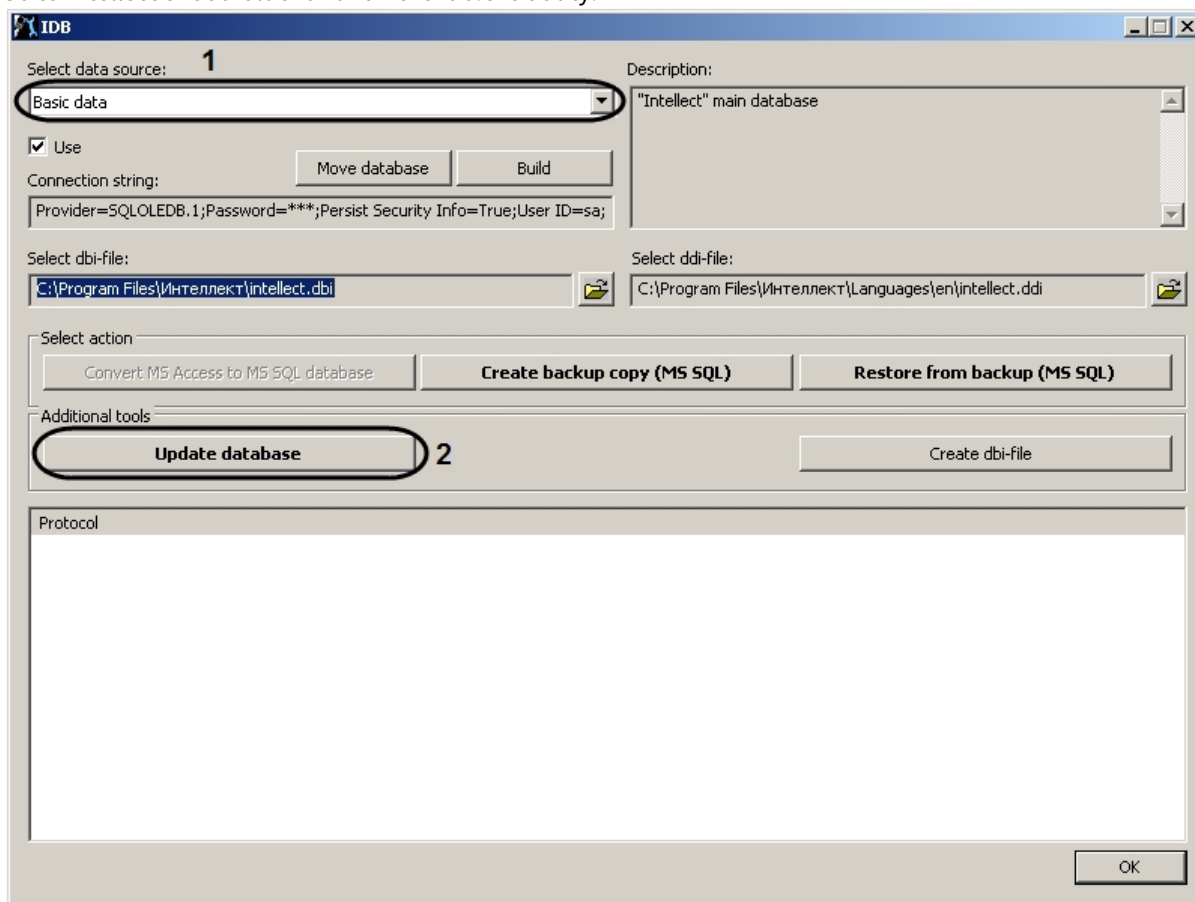

5. In the **Select data source** list, select **Basic data** (1).

- Click the **Update database** button (2).

The system will start updating the database structure. The progress will be shown in the **Protocol** window of `idb.exe`.

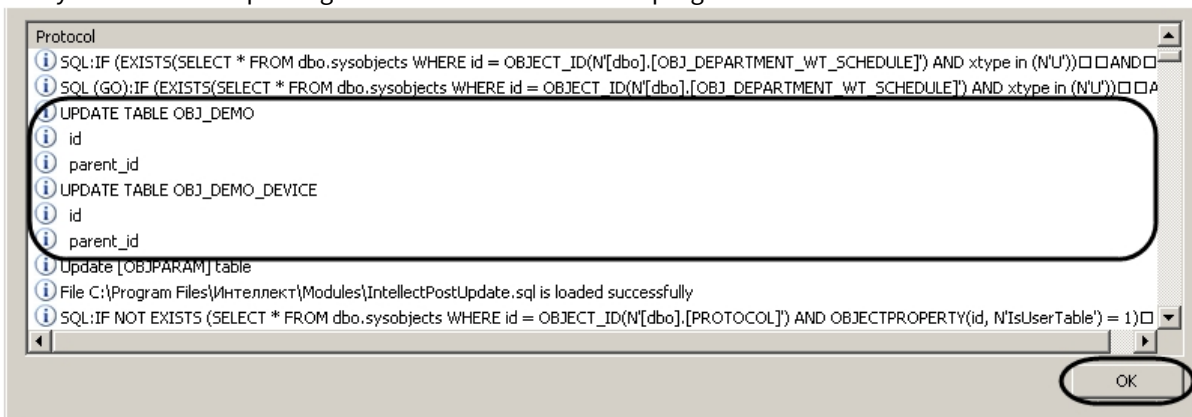

- Click **OK** to close `idb.exe`.

As a result of the database structure update, tables are created in *Intellect's* configuration database.

### 2.1.2.2 Using the `ddi.exe` Tool to Work with DBI files

To add an object to the DBI file by using the `ddi.exe` utility, do the following:

- Go to the `Intellect\Tools` folder and run `ddi.exe`.
- In the program window, select the **DBI** tab.
- In the **File** menu, select **Open**. The **Open** dialog box appears.
- Go to Intellect's root folder and select the `intellect.dbi` file. The `ddi.exe` window shows a list of objects.
- To add the new object, in the list's context menu, select **Add**.

**Note:**  
You may add a new object by pressing the **Insert** key as well.

- A dialog box opens. In the **ID** field, enter an object name (used for identification) and click **OK**.

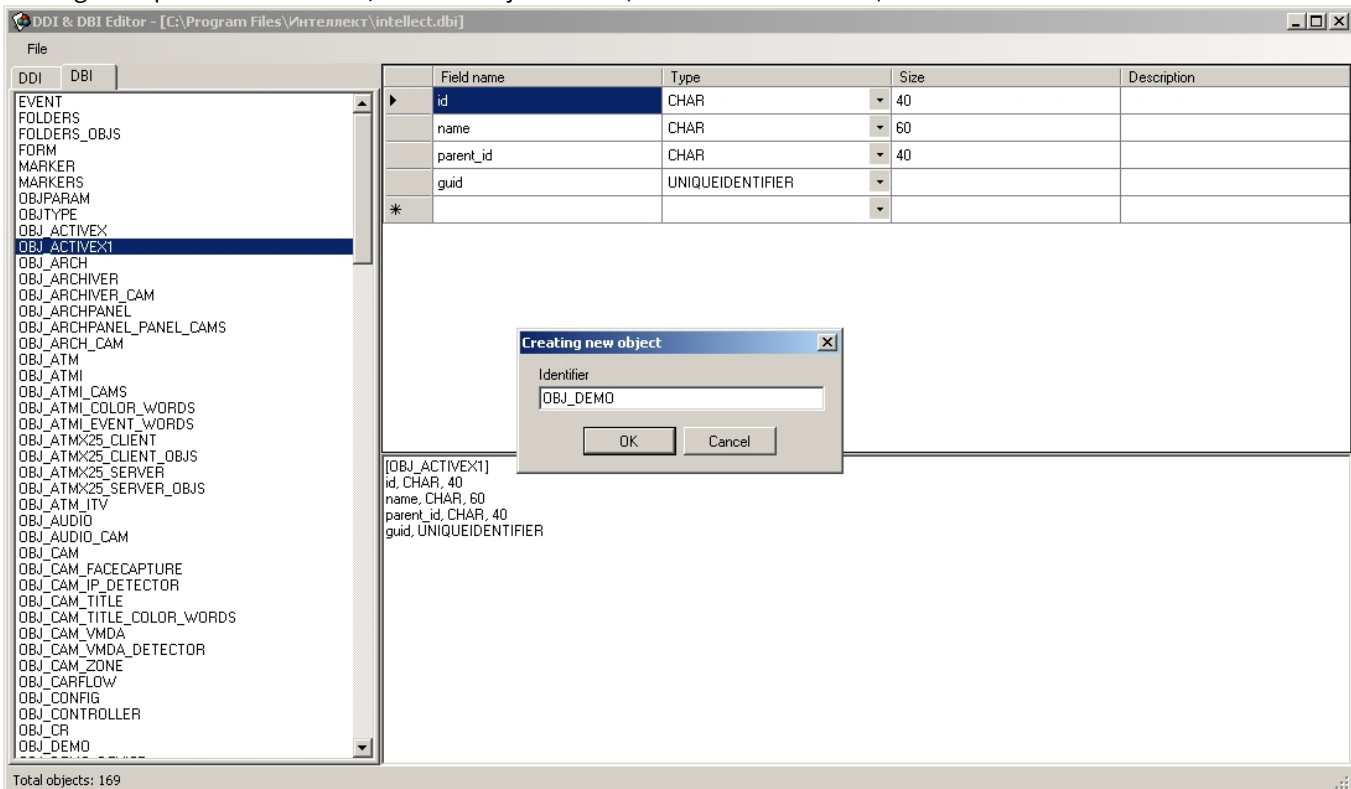

**Note:**

The mandatory fields are automatically added to the created object (see Section [Adding Objects to Intellect.dbi](#)).

The object has now been added to the DBI file.

To add a field:

1. In the left part of the *ddi.exe* window, select an object.
2. Add a description of the new field (a string) to the table.

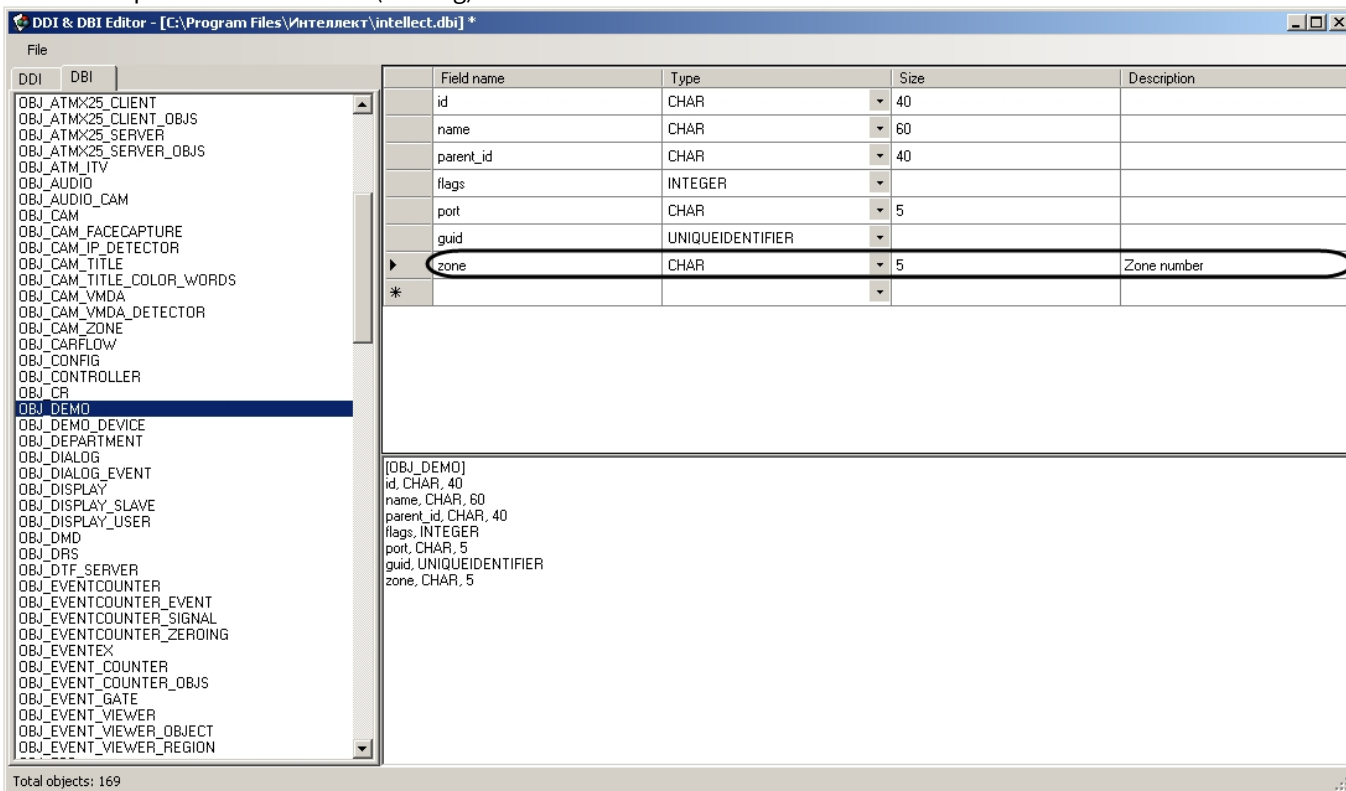

3. To save the changes, in the **File** menu, select **Save**.

The new field is now added.

**Attention!**

After making changes to the DBI file, you must update the database structure by using *idb.exe* (see [Adding Objects to Intellect.dbi](#)).

### 2.1.3 Editing the DDI file

The DDI file is an XML file that contains the following object information:

1. Reactions (that is, actions that the objects may perform).
2. Events that the objects may generate.
3. States of the objects.
4. Event-driven rules for state transition.
5. The names of the BMP files that are used for visualizing the objects on the *Map*.

The *intellect.ddi* file contains the properties of Intellect's main objects. For your own objects, we recommend creating a separate file, *intellect.xxx.ddi*, where *xxx* is a unique part of the filename. By using a separate file, you avoid double inclusion of the properties after an update of the Intellect software package. On startup of the software package, the DDI files are merged.

If an object is duplicated in several ddi-files, then at Intellect software startup the properties of the object from the last file are applied in accordance with the sorting of files by name. For example, if an object is described in files intellect.xxx.ddi, intellect.xxx1.ddi and intellect.xxx2.ddi, the properties from the intellect.xxx2.ddi will be applied.

### 2.1.3.1 Adding Object Information to intellect.ddi

This section shows how to add information on the **DEMO** object to intellect.ddi by using a text editor.

To add information on the **DEMO** object, do the following:

1. Go to *Intellect\Languages\en* folder and open the intellect.dbi file with a text editor.
2. Into the **<DataSetDDI>** section, add a child element, **<Objects>**, which contains an object description.

```
<Objects>
  <ObjectName>DEMO</ObjectName>
  <VisibleName>Demo object</VisibleName>
  <GroupName></GroupName>

  <Events>
    <EventName>LOST</EventName>
    <EventDescription>Connection lost</EventDescription>
    <IsSoundEnabled>>false</IsSoundEnabled>
    <IsNetworkDisabled>>false</IsNetworkDisabled>
    <IsProtocolDisabled>>false</IsProtocolDisabled>
    <IsWindowsLogEnabled>>false</IsWindowsLogEnabled>
  </Events>
  <Events>
    <EventName>RESTORE</EventName>
    <EventDescription>Connection restored</EventDescription>
    <IsSoundEnabled>>false</IsSoundEnabled>
    <IsNetworkDisabled>>false</IsNetworkDisabled>
    <IsProtocolDisabled>>false</IsProtocolDisabled>
    <IsWindowsLogEnabled>>false</IsWindowsLogEnabled>
  </Events>
  <Icons>
    <FileName>demo</FileName>
    <IconName>demo</IconName>
  </Icons>
  <States>
    <StateName>DETACHED</StateName>
    <ImgName>detached</ImgName>
    <StateDescription>Armed</StateDescription>
    <IsStateFlashing>>false</IsStateFlashing>
  </States>
  <States>
    <StateName>NORMAL</StateName>
    <ImgName>normal</ImgName>
    <StateDescription>Disarmed</StateDescription>
    <IsStateFlashing>>false</IsStateFlashing>
  </States>
  <Rules>
    <EventName>RESTORE</EventName>
    <FromStateName>DETACHED</FromStateName>
    <ToStateName>NORMAL</ToStateName>
  </Rules>
  <Rules>
    <EventName>LOST</EventName>
    <FromStateName>NORMAL</FromStateName>
    <ToStateName>DETACHED</ToStateName>
  </Rules>
</Objects>
```

**Note.**

For the **DEMO** object, the **<Reacts>** sections is missing, because this object does not perform any actions.

**Note.**

The DDI file elements are described in detail in [APPENDIX 1. DDI file structure](#).

- Save the changes to the intellect.ddi file.

The information on the **DEMO** object has now been added to intellect.ddi.

**Attention!**

After making changes to the DDI file, you must update the database structure by using `idb.exe` (see Steps 4–7 in Section [Adding Objects to Intellect.dbi](#)).

### 2.1.3.2 Using the ddi.exe Tool to Work with DDI files

This section shows how to add information on the **DEMO\_SERVICE** object to intellect.ddi by using the `ddi.exe` tool.

To add information on the **DEMO\_DEVICE** object, do the following:

- Open intellect.ddi file in one of the following ways:
  - Go to the `Intellect\Tools` folder and run `ddi.exe`.
    - In the program window, select the **DDI** tab.
    - In the **File** menu, select **Open**. The **Open** dialog box appears.
    - Go to the `Intellect\Languages\en` folder and select `intellect.ddi`. The window of `ddi.exe` shows a list of objects.
  - Open the `Intellect\Tools` folder in Windows Explorer or any other file manager, then double-click the `intellect.ddi` file.
- Add the object by selecting **Add** in the list's context menu or by pressing the **Insert** key.
- A dialog box opens. In the **ID** field, enter an object name (used for identification) and click **OK**.

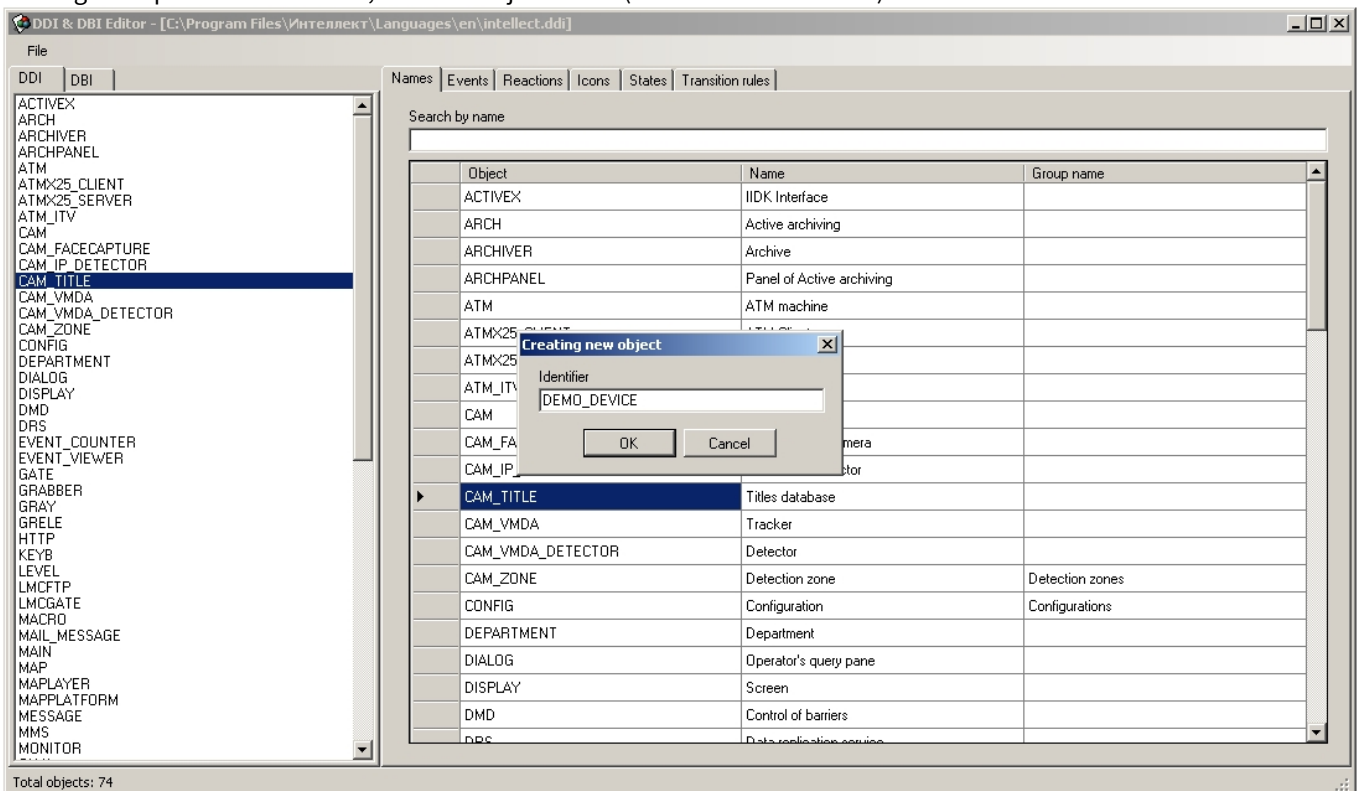

The **DEMO\_DEVICE** object is now shown in the list of objects.

- In the **Names** tab, enter an object name.

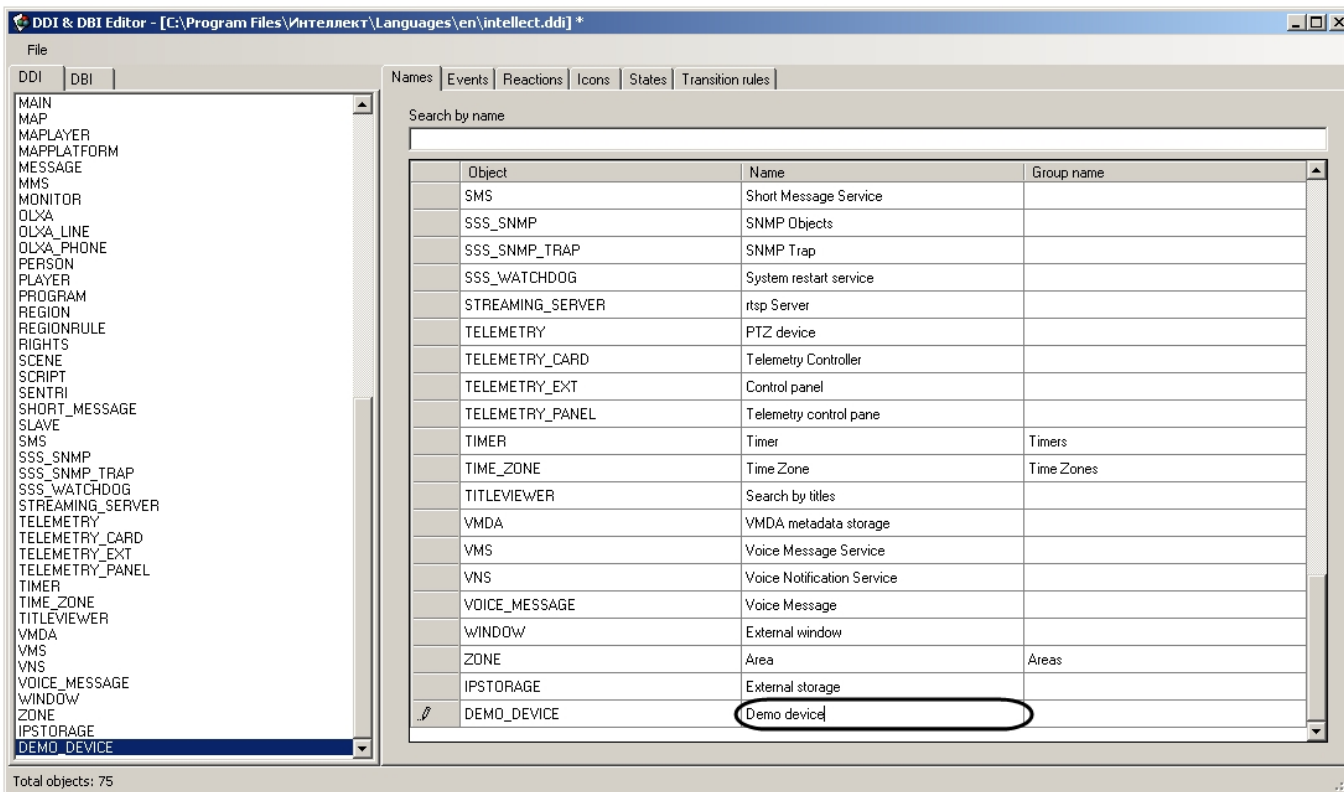

5. In the relevant tabs, add information on the DEMO\_DEVICE object.

a. In the **Events** tab, add the **ON** and **OFF** events.

Names	Events	Reactions	Icons	States	Transition rules	
Name	Description	Processing messages	Support audio	Disable network connection	Disable logging	Windows log
ON	Device is active		<input type="checkbox"/>	<input type="checkbox"/>	<input type="checkbox"/>	<input type="checkbox"/>
OFF	Device is inactive		<input type="checkbox"/>	<input type="checkbox"/>	<input type="checkbox"/>	<input type="checkbox"/>
*			<input type="checkbox"/>	<input type="checkbox"/>	<input type="checkbox"/>	<input type="checkbox"/>

b. In the **Reactions** tab, add the **ON** and **OFF** actions.

Names	Events	Reactions	Icons	States	Transition rules
Reaction	Description	Arming			
ON	Enable	<input type="checkbox"/>			
OFF	Disable	<input type="checkbox"/>			
*		<input type="checkbox"/>			

c. In the **Icons** tab, enter a BMP file name (the part that serves as an image ID). Image IDs allow you to use multiple BMP files to show objects of the same type on the **Map**.

Names	Events	Reactions	Icons	States	Transition rules
File name	Name				
demo_device	DEMO module				
*					

d. In the **States** tab, add the **ON** and **OFF** states. To show an object state on the **Map**, enter a BMP file name (the part that serves as an ID of the state).

Names	Events	Reactions	Icons	States	Transition rules
Name	Image	Description	Flicker when alarm		
ON	on	Enabled	<input type="checkbox"/>		
OFF	off	Disabled	<input type="checkbox"/>		
*			<input type="checkbox"/>		

**Note.**

The names of the BMP files in the Intellect\Bmp folder must have the following format:  
 <Image ID>\_<State ID>  
 If an image ID is not set, the BMP file name must be the following:  
 <Object ID>\_<State ID>

**Note.**

The Map may show objects using lines (that is, without using BMP files). In this case, when an object changes its state, the line color changes. For a state, the color (RGB) is set as follows:  
 <State>\$R:G:B

- e. In the **Transition Rules** tab, set a rule for transitioning from one state to another after a certain event.

Names	Events	Reactions	Icons	States	Transition rules
	Event				Transition from state
	OFF				ON
	ON				ON
	*				
					Transition to state
					OFF
					ON

**Note.**

If the **Transition from state** field is left blank, the rule will apply to all starting states.

6. To save changes, in the **File** menu, select **Save**.

The information on the DEMO\_DEVICE object is now added.

**Note:**

The fields of the ddi.exe tables are described in detail in [APPENDIX 1. DDI file structure](#).

**Attention!**

After making changes to the DDI file, you must update the database structure by using idb.exe (see Steps 4–7 in Section [Adding Objects to Intellect.dbi](#)).

## 2.1.4 Additional Functionality of the ddi.exe Utility

The *ddi.exe* tool allows you to conveniently delete, add, and edit object properties (such as events and reactions), and copy them to the clipboard. In addition, you can copy object events to the clipboard, as a parameter of the *NotifyEvent* function. To do this, follow the steps below:

1. In the object list's context menu, select **Copy the list of events with NotifyEvent()**.

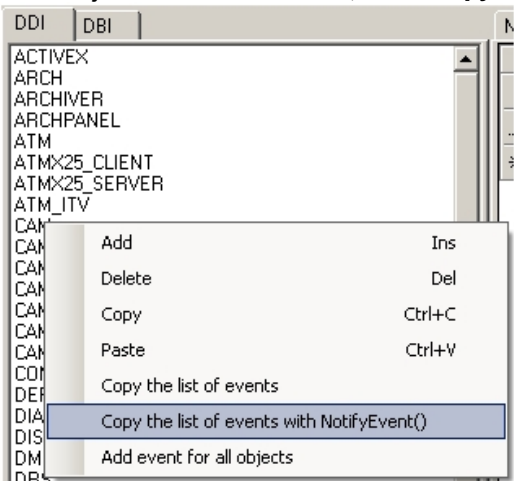

2. A dialog box opens. In the dialog box, enter the object ID to be used by the NotifyEvent function and click **OK**.

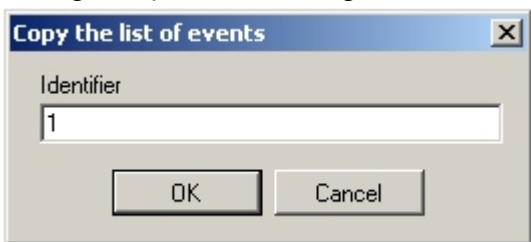

The event list is now copied. The clipboard contains object events in the format shown in the figure below.

```

NotifyEvent("CAM", "1", "ARM");
NotifyEvent("CAM", "1", "ATTACH");
NotifyEvent("CAM", "1", "BLINDING");
NotifyEvent("CAM", "1", "DETACH");
NotifyEvent("CAM", "1", "DISARM");
NotifyEvent("CAM", "1", "DISC_MOUNT");
NotifyEvent("CAM", "1", "DISC_UNMOUNT");
NotifyEvent("CAM", "1", "FILE_REC_ERROR");
NotifyEvent("CAM", "1", "MD_START");
NotifyEvent("CAM", "1", "MD_STOP");
NotifyEvent("CAM", "1", "PRINT");
NotifyEvent("CAM", "1", "REC");
NotifyEvent("CAM", "1", "REC_STOP");
NotifyEvent("CAM", "1", "RECORDER_OFF");
NotifyEvent("CAM", "1", "RECORDER_ON");
NotifyEvent("CAM", "1", "UNBLINDING");
    
```

To add an event for all objects, in the context menu, select **Add Event for All Objects**. The **Add for All Objects** dialog box opens. In the dialog box, specify the parameters of the new event.

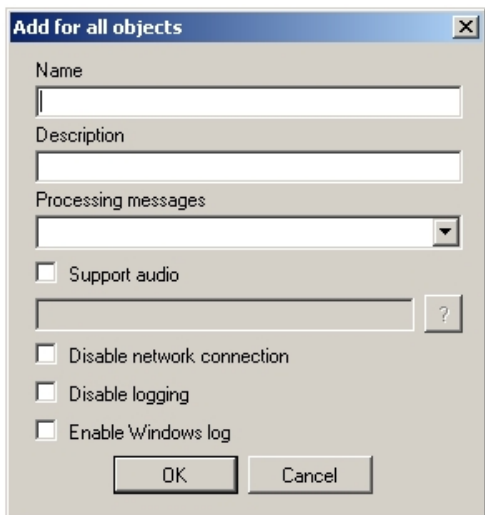

To add objects from other DBI and DDI files, in the **File** menu, select **Insert from File**.

### 2.1.5 Creating MDL files

To create an MDL file, use two classes:

1. *NissObjectDLLExt*. All objects inherit from this class, whose virtual methods are redefined.
2. *CoreInterface*. The methods of this class are used to get parameters of the system's objects.

The declared classes and methods are contained in the nissdll.h header file. The code contained in the nissdll.h file is shown in [APPENDIX 2. NissObjectDLLExt and CoreInterface class declarations](#).

**Note:** The methods of a class are the procedures and functions declared in its body.

The methods of the *NissObjectDLLExt* class are described in the table below.

Method	Description	Example
CoreInterface* m_pCore	A pointer to the core interface	
virtual BOOL IsWantAllEvents()	Returns TRUE if the OnEvent function receives events from all objects; returns FALSE if the function receives events from its own object only.	If "CAM,GRABBER" is passed as a parameter, when settings of these objects are modified, the DEMO object receives the following messages:
virtual CString DescribeSubscribe ObjectsList()	The method accepts a comma-separated list of objects. When an object from the list is modified, the current object is notified.	DEMO 1 UPDATE_CAM parameters of the camera DEMO 1 UPDATE_GRABBER parameters of the video capture card
virtual CString GetObjectType()	Returns the object type	<pre>virtual CString GetObjectType() { return "DEMO"; }</pre>

Method	Description	Example
virtual CString GetParentType()	Returns the parent object type	<pre>virtual CString GetParentType() { return "SLAVE"; }</pre>
virtual int GetPos()	Returns the position of the object in the <i>intellect.sec</i> key file. Attention! This parameter must be set in consultation with AxxonSoft.	<pre>virtual int GetPos() { return -1; }</pre> <p><i>Note: If Intellect is run in the demo mode, the function returns -1</i></p>
virtual CString GetPort()	Returns the number of the port used for communication between the object and the core. <b>Attention! This parameter must be set in consultation with AxxonSoft.</b>	<pre>virtual CString GetPort() { return "1100"; }</pre>
virtual CString GetProcessName()	Returns the process name. Used by the core to search for and automatically run the executable module on startup of the system and initialization of the module	<pre>virtual CString GetProcessName() { return "demo"; }</pre>
virtual CString GetDeviceType()	Determines the type of the object and its behavior. ACD – objects of this type receive all events related to the creation, modification, and deletion of the following objects: <b>Users, Time Zone, and Access Levels</b> ACD2 – a type similar to ACD, providing the additional (provided by the core) functionality of deleting temporary (fixed-term) cards The ACR type means that the object is a reader	All objects of the ACR type are available in the <b>Access Point</b> drop-down list
virtual BOOL HasChild()	Returns TRUE if the object has child objects, FALSE otherwise.	<pre>virtual BOOL HasChild() { return TRUE; }</pre>
virtual UINT HasSetupPanel()	Returns TRUE if the object has a setup panel, FALSE otherwise	<pre>virtual UINT HasSetupPanel() { return TRUE; }</pre>
virtual void OnPanelInit(CWnd *)	Used when the object's setup panel is initialized. The parameter is a pointer to the setup panel's window.	

Method	Description	Example
virtual void OnPanelLoad(CWn d*,Msg&)	Used when the setup panel is loaded for setting the parameters of the object. The parameters are the setup panel's window and a message used to pass the parameters and fill in the relevant fields of the setup panel.	<pre data-bbox="975 309 1497 779"> virtual void OnPanelLoad(CWnd* pwnd,Msg&amp; params)  {  CString s;  s = arams.GetParam("port");  pwnd-&gt;GetDlgItem(IDC_PORT)-&gt; SetWindowText(s);  } </pre>
virtual void OnPanelSave(CWn d*,Msg&)	Used when the setup panel is saved for saving the parameters of the object. The parameters are a pointer to the setup panel's window and a reference to a message used to pass the parameters and save them in a database.	<pre data-bbox="975 925 1497 1395"> virtual void OnPanelSave(CWnd* pwnd,Msg&amp; params)  {  CString s;  pwnd-&gt; GetDlgItem(IDC_PORT)-&gt; GetWindowText(s);  params.SetParam("port",s);  } </pre>
virtual void OnPanelExit(CWn d*)	Used when the object's setup panel is closed ("exited"). The parameter is a pointer to the setup panel's window.	

Method	Description	Example
virtual void OnPanelButtonPressed(CWnd*,UINT)	Used to handle clicks on the setup panel's buttons. The parameters are a pointer to the setup panel's window and a button ID.  <i>Note: A button ID must be a number equal to or greater than <b>1151</b>. For example, the Resource.h file defines the ID of the <b>Test</b> button as follows:</i>  <b>#define IDC_TEST 1151</b>	<pre>Virtual void OnPanelButtonPressed (CWnd* pwnd,UINT id)  {  <b>if</b>(id==IDC_TEST)  { React react("DEMO",Id,"TEST"); m_pCore-&gt;DoReact(react); }  }</pre>
	If a button click is to open your own dialog box created in the same MDL file, you must first use the code shown in the example below.	<pre>HINSTANCE prev_hinst = AfxGetResourceHandle();  HMODULE hRes = GetModuleHandle("demo.mdl");  If (hRes) AfxSetResourceHandle (hRes);  //Code for showing a dialog box:  CXXXDialog dlg;  dlg.DoModal();  AfxSetResourceHandle(prev_hinst) ;</pre>
virtual BOOL IsRegionObject()	Shows whether the object supports Intellect's regions. Regions are used to group objects. They can also be used in the report system.	
virtual BOOL IsProcessObject()	Shows whether the object supports starting and running multiple executable modules simultaneously. For example, this may be used for starting a separate module for each COM port.  <i>Note: We recommend using one RUN file. This makes it easier to debug and modify the module.</i>	

Method	Description	Example
virtual void OnCreate(Msg&)	Used when the object is created. The parameter is a reference to a message that contains object information. The method is also used to set default parameters.	<pre data-bbox="975 309 1497 584">virtual void OnCreate (Msg&amp; msg) { msg.SetParam ("port","COM1"); }</pre>
virtual void OnInit(Msg&)	Used when the object is initialized. The parameter is a reference to a message that contains object information.	<pre data-bbox="975 689 1497 965">virtual void OnInit (Msg&amp; msg) { OnChange (msg, msg); }</pre>
virtual void OnChange(Msg&, Msg&)	Used when the object is changed. The first and second parameters are references to messages that contain object information before and after the change, respectively.	<pre data-bbox="975 1032 1497 1563">virtual void OnChange(Msg&amp; msg, Msg&amp; prev) { React react (msg.GetSourceType(), msg.GetSourceId(),"INIT");  react.SetParam("port",msg.GetPar am("port"));  m_pCore-&gt;DoReact(react); }</pre>

Method	Description	Example
virtual void OnDelete(Msg&)	Used when the object is deleted. The parameter is a reference to a message that contains object information.	<pre data-bbox="975 309 1497 712"> virtual void OnDelete (Msg&amp; msg) {     React react     (msg.GetSourceType(),     msg.GetSourceId(), "EXIT");      m_pCore-&gt; DoReact(react); } </pre>
virtual void OnEnable(Msg&)	Used to handle clicks on the <b>Disable</b> button of Intellect's panel when the object is enabled. The parameter is a reference to a message that contains object information.	
virtual void OnDisable(Msg&)	Used to handle clicks on the <b>Disable</b> button of Intellect's panel when the object is disabled. The parameter is a reference to a message that contains object information.	

Method	Description	Example
virtual BOOL OnEvent(Event&)	Used to handle the events that are passed as the parameter.	<pre> virtual BOOL OnEvent(Event&amp; event) { If     (event.GetAction() == "ACCESS_IN"    event.GetAction() == "ACCESS_OUT")  {     Msg per = m_pCore-&gt; FindPersonInfoByCard(event.GetPa ram("facility_code"), event.GetParam("card"));  event.SetParam ("param0", ! per.GetSourceId().IsEmpty() ? per.GetParam("name") : event.GetParam("facility_code") + event.GetParam("card"));  event.SetParam("param1", per.GetSourceId() ); }  Else  If (event.GetAction() == "NOACCESS_CARD") { event.SetParam </pre>

Method	Description	Example
		<pre> ("param0",event.GetParam("facili ty_code") + event.GetParam("card"));  }  return TRUE;  } </pre>
virtual BOOL OnReact(React&)	Used to handle the reactions that are passed as the parameter.	

The *CreateNissObject(CoreInterface\* core)* global function creates instances of the described objects, places them in an array (an instance of *CNissObjectDLLExtArray*), and returns a pointer to this array. This function is used to receive a pointer to the core interface. This pointer is later used by objects to call interface methods:

```

CNissObjectDLLExtArray* APIENTRY CreateNissObject(CoreInterface* core)
{
    CNissObjectDLLExtArray* ar = new CNissObjectDLLExtArray;
    ar->Add(new NissObjectDemo(core));
    ar->Add(new NissObjectDemoDevice(core));
    return ar;
}

```

After loading a DDL file, the core calls the *CreateNissObject* function and receives pointers to all the objects in use.

All object setup panels are stored in resources as dialogs. Each dialog ID has the format **IDD\_object\_SETUP**, where **object** is the name of the corresponding object. For example, the ID of the **DEMO object** is **IDD\_DEMO\_SETUP**, and the ID of the **DEMO\_DEVICE** object is **IDD\_DEMO\_DEVICE\_SETUP**.

 **Note:**

If you want for the settings tree to show a special icon for a particular object, in the resources of the DLL file, create a 14x14 **BITMAP** that contains the object name,.

### 2.1.5.1 MDL File Creation Wizard

To automate the creation of MDL files, use *intellect\_md1.awx* (see the *Wizard* folder in archive on page [Intellect Software Integration Guide \(HTTP API, IIDK, ActiveX\)](#)).

Use the Wizard to create an MDL file as follows:

1. Copy *intellect\_md1.awx* to the folder *Program Files|Microsoft Visual Studio|Common|MSDev98|Template*.
2. Start *Microsoft Visual C++*.
3. Create a new project with the name of **INTELLECT MDL WIZARD**.
4. Follow the instructions of the project configuration wizard.

As a result, a template for the system object is created. The project includes all of the necessary files, including a file that describes the object structure for *intellect.dbi*.

 **Attention!**

In the project settings, change the output file extension from DLL to MDL.

**Note:**

For building the project, use **Release**.

## 2.1.6 Creating RUN files

Devices are managed by exchanging messages (commands) between RUN files and the system core. For implementing this interaction between software modules and the core, use the *Intellect Integration Developer Kit (IIDK)*, which is covered in detail in Section [Intellect Integration Developer Kit \(IIDK\)](#). Other information is provided by the source files of the demonstration module; the files may be found in an appendix to this documentation.

Below is an example of how the *IIDK* is used in the *DEMO* module.

```
CString port = "1100";

CString ip = "127.0.0.1";

CString id = "";

BOOL IsConnect = Connect (ip, port, id, myfunc);

if (!IsConnect)
{
    // connection failed

    AfxMessageBox("Error");

    Return;
}

SendMsg(id,"CAM|1|REC"); // turn on recording for camera 1

SendMsg(id, "DEMO|1|RESTORE"); // restore the connection with the DEMO object

//turn on the DEMO_DEVICE with address 1

SendMsg(id,"DEMO_DEVICE|1|ON|params<1>,param0_name<address>,param0_val<1>");

Disconnect(id);
```

**Attention!**

If an MDL file exists, connecting to Intellect's core does not require creating an IIDK Interface object in the system. The connection ID passed is an empty string (in other words, the ID is "").

When a module is unloaded, it receives the **WM\_EXIT** event:

```
#define WM_EXIT (WM_USER+2000)
```

Use a WinAPI function, *PostThreadMessage*, to catch this message and ensure that the module is unloaded properly. In *VC++* and *MFC*, the **WM\_EXIT** event is caught in a subclass of *CWinApp*; in *Delphi* and *CBuilder*, it is caught in a subclass of *TApplication*.

## 2.1.7 Creating and Configuring Integrated Objects (Modules) in Intellect

To create and configure an integrated object (module) in Intellect:

1. Copy the MDL and RUN files to the *Intellect\Modules* folder.
2. Start Intellect.
3. Under the **Computer** object, create the objects added earlier using the software module. For the *DEMO* module, Under the **Computer** object, create the **DEMO** object.

**Note:**  
Under the **DEMO** object, create a child object, **DEMO\_DEVICE**.

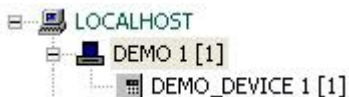

As a result, the setup panels of the created objects become available.  
DEMO object setup panel:

DEMO\_DEVICE object setup panel:

4. Set up the objects.

The integrated objects are now created and set up in Intellect.

## 2.2 Intellect Integration Developer Kit (IIDK)

### 2.2.1 General Information on IIDK

#### 2.2.1.1 Purpose of the IIDK

System expandability is supported by Intellect's software architecture. Expandability allows communication between the core and functional modules (third party information systems) via TCP/IP.

The figure below shows a diagram of interaction between Intellect's core and external software (a functional module).

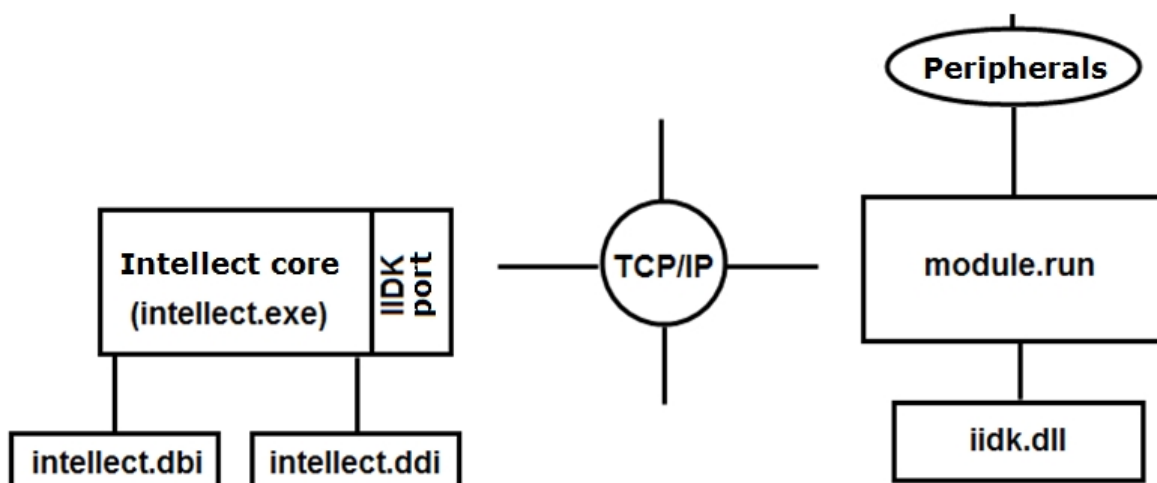

Interaction is done by exchanging messages in a communication environment; message exchange is implemented by using the *IIDK*.

The *Intellect Integration Developer Kit (IIDK)* is a set of development tools for integrating third-party security software into Intellect. This kit allows you to expand the system rapidly and effectively by adding functional modules that support new hardware and new functions.

#### 2.2.1.2 Developer Requirements

To use the *IIDK*, you must:

1. know how to program in C/C++;
2. know the basics of Win32 programming;
3. have an IDE with DLL support (such as *Microsoft Visual C++*, *C++ Builder*, or *DELPHI*).

#### **Note:**

When creating LIB files with C++ Builder 5's implib.exe tool, add the “- a” option.

#### 2.2.1.3 IIDK Components

The *IIDK* includes the following development tools:

1. *iidk.ocx* – ActiveX control. When installing *Intellect* this file is stored in the Windows\System32 folder and registered in OS.
2. *ddi.exe* – tool used for viewing and editing DDI- and DBI- files. It is stored in the <Intellect installation directory>\Tools folder.

## 2.2.2 Connecting to Intellect

### 2.2.2.1 Connection Parameters

Intellect's core interacts with functional modules (third party information systems) according to the following connection parameters:

1. Port number.
  - a. For the video subsystem: 900.
  - b. For the **Interface IIDK** object: 1030.
  - c. For **ATM** objects: 1009.

**Note.**

1030 (IIDK) port can be in use to connect ATMs (ATM) (not only 1009 port) - in this case the **ATM** object will be marked with red cross in the hardware tree. For this the **IIDK Interface object is to be created in the hardware tree.**

2. The IP address of the computer that is running Intellect's core.
3. ID (the connection object ID).

**Attention!**

To connect to video subsystem (port 900) id is to be more than 1 and must not be the same as id of **IIDK Interface objects created in the system**. To connect to **IIDK Interface object** (port 1030) id is to be the same as one of the object specified in the dialog box of *Intellect* settings.

**Note.**

If connection to the server (**IIDK Interface object**) from remote computer is required, then there is no need to install *Intellect* on the remote computer, but this computer is to be added to *Intellect* configuration on the server (in the **Hardware** tab of the **System settings** dialog box) and **IIDK Interface object** is to be created under the created **Computer** object. In this case the server address is to be specified in IP parameter of Connect function and ID of specified **IIDK Interface object** is to be specified in ID parameter. Take into account the fact that the **Computer** object corresponding to the remote computer is marked with a red cross in the object tree.

**Note:**

If an MDL file exists (see Section [Creating MDL files](#)), the connection to Intellect's core does not require creating the **IIDK Interface** object in the system. The connection ID passed is an empty string (in other words, the ID is "").

### 2.2.2.2 IIDK Interface Object

With the **IIDK Interface** object one can manage all the elements of the system. The **IIDK Interface** object is created under the **Computer** object in the *Intellect* object tree.

**Note**

To use the **IIDK Interface** object, allow the relevant functionality in the license key.

**Note**

If *Intellect* is started in the demo mode, the **IIDK Interface** object is activated after the functional module is connected to the system core (see [Connect](#) section)

**Important!**

The ID of the **IIDK Interface** object must not be the same as the IDs of the **Monitor** objects created in the system.

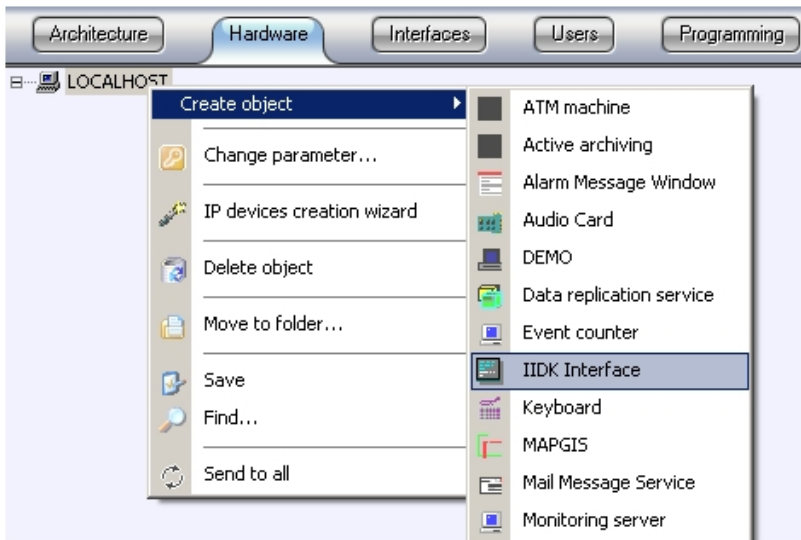

If the **IIDK Interface** object is used, the settings panels are not created for integrated functional modules (third party applications).

When the *Intellect* distributed architecture is used, the **IIDK Interface** object must be created on the computer that is running the software core (the core to which the connection is made). If the connection is made to a computer that has the *Operator Workstation* installed, the connection parameters must include the IP address of the *Server* or the *Administrator Workstation*.

### 2.2.2.3 Configuring passing events through IIDK Interface object

**IIDK Interface** allows configuring of event filtering passed to connected client applications.

To configure filtering, do the following:

1. Go to the settings panel of the created **IIDK Interface** object.

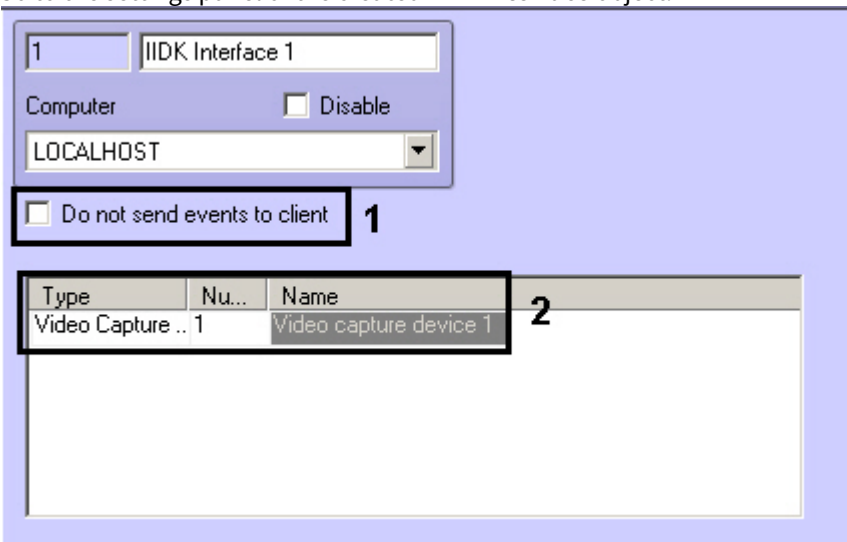

2. Set the **Do not send events to client** if it is not required to send any messages to client application (1).
3. In the table (2) specify list of objects, events from which have to be sent to connected client applications.

Configuring of event filtering is completed.

## 2.2.2.4 Features of ATMs integration. ATM object

The **ATM** object can be used to send events from ATM software to *Intellect* core. This object is created under the **LOCALHOST** object in the **Hardware** tab of the **System settings** dialog box. It is created instead of the **IIDK Interface** object.

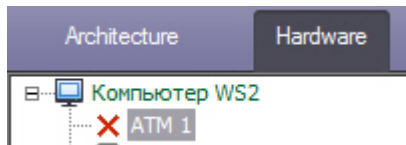

The **ATM** object shows ATM events (“Card inserted”, “Withdraw card”, etc.) in the event viewer. These events can be used for captioning, reactions configuration, etc.

### **Note.**

For events regarding client card masked bank card number can be sent in the param0 parameter.

The list of available **ATM** events can be seen using the ddi.exe utility. Information on how to use this utility can be found in the [The ddi.exe utility for editing database templates and external settings files](#) section of *Administrator's Guide*.

Connection method and message syntax for the **ATM** object are the same as those for the **IIDK Interface object**, though 1009 port is in use for sending messages (see also [Connection Parameters](#) and [Message Syntax \(port 900\)](#)).

## 2.2.3 IIDK Functions

### 2.2.3.1 Connect

To establish communication between a functional module and Intellect, connect to the system core by using the following function:

```
BOOL Connect (LPCTSTR ip, LPCTSTR port, LPCTSTR id, void (_stdcall *func)(LPCTSTR msg))
```

Parameters of the connection function:

Parameter	Description	Example
LPCTSTR ip	The ID address of the computer that is running the system core	<pre>CString port = "900";  CString ip = "127.0.0.1";  CString id = "2";  BOOL IsConnect = Connect(ip, port, id, myfunc);  if (!IsConnect) {     // connection failed      AfxMessageBox("Error"); }</pre>
LPCTSTR port	TCP/IP connection port	
LPCTSTR id	A connection ID, for video	
_stdcall *func) (LPCTSTR msg)	A callback function that accepts messages from Intellect	

The function returns TRUE if the connection is established, or FALSE if not.

All messages from the system core are accepted by a callback function.

A sample declaration of the callback function:

```
void _stdcall myfunc(LPCTSTR str)
{
    printf("\r\nReceived:%s\r\n\r\n",str);
}
```

 **Note:**

**Void \_stdcall myfunc** is called in a separate stream (not in the application's main stream).

The developer handles received messages as needed.

### 2.2.3.2 SendMsg

To send messages to the system core, use the following function:

```
BOOL SendMsg (LPCTSTR id, LPCTSTR msg)
```

Parameters of the SendMsg function:

Parameter	Description	Example
LPCTSTR id	The connection ID passed in the call to the <b>Connect</b> function	<pre> CString port = "900";  CString ip = "127.0.0.1";  CString id = "2";  BOOL IsConnect = Connect(ip, port, id, myfunc);  <b>if</b> (!IsConnect) { // connection failed  AfxMessageBox("Error");  Return; }  SendMsg(id,"CAM 1 REC"); // turn on recording for camera 1  Disconnect (id); </pre>
LPCTSTR msg	Message text	

The function returns TRUE if the message was sent, otherwise FALSE

### 2.2.3.3 Disconnect

To terminate a connection, use the **Disconnect** function:

```
void Disconnect (LPCTSTR id)
```

, where **LPCTSTR id** is the connection ID passed in the call to the **Connect** function.

If the connection is terminated by Intellect, **DISCONNECTED** is passed to the callback function.

**Note:**

An example of using the **Disconnect** function is given in Section [SendMsg](#).

## 2.2.3.4 Other functions

### On the page:

- [Connect3](#)
- [SendReactToCore](#)
- [IsConnected](#)
- [Connect4](#)
- [SendData4](#)
- [SendFile](#)
- [GetMsg](#)

The iidk.h header file contains extra functions that are listed below. The Connect4, SendData4, SendFile and GetMsg functions should not be used. They are created for internal use. The Connect2 function is not used.

### 2.2.3.4.1 Connect3

```
BOOL Connect3(LPCTSTR ip, LPCTSTR port, LPCTSTR id, iidk_callback_func* lpfunc,
              DWORD user_param, int async_connect, DWORD connect_attempts)
```

Parameter	Description
ip	IP address of <i>Intellect</i> Server
port	TCP/IP port over which the connection is established
id	Slave connection ID, for video
lpfunc	Callback function receiving messages from <i>Intellect</i>
user_param	Extra parameter that comes to Callback function in order to split slaves if there is only one function.
async_connect	0 - synchronous connection mode, the function returns TRUE if the connection is established. -1 - asynchronous connection mode, the function always returns FALSE if the connection is established, then the CONNECTED event is created. Any other value - at first the synchronous mode is used, in case of fault - asynchronous mode.
connect_attempts	Number of connection attempts.

### 2.2.3.4.2 SendReactToCore

The function is used to send a reaction to the specific core.

```
BOOL SendReactToCore(LPCTSTR id, LPCTSTR msg)
```

Parameter	Description
id	Core connection ID

msg	Messages sent. Message format is similar to <a href="#">SendMsg</a> .
-----	---

### 2.2.3.4.3 IsConnected

IsConnected returns TRUE if the client is connected to server.

```
BOOL IsConnected();
```

### 2.2.3.4.4 Connect4

```
BOOL Connect4(LPCTSTR ip, LPCTSTR port, LPCTSTR id, iidk_callback_func* lpfunc,
              iidk_frame_callback_func* lpframe_func, iidk_user_data_func*
              iidk_user_data_func,
              DWORD user_param, int async_connect, DWORD connect_attempts);
```

Parameter	Description
ip	IP address of <i>Intellect</i> Server
port	TCP/IP port over which the connection is <i>established</i>
id	Core connection ID, for video
lpfunc	Callback function receiving messages from <i>Intellect</i>
lpframe_func	Callback function receiving video frames
iidk_user_data_func	Callback function for data sent using the SendData4 function
user_param	Extra parameter that comes to the Callback function in order to split slaves if there is only one Callback function for all cores.
async_connect	0 - synchronous connection mode, the function returns TRUE if the connection is established -1 - asynchronous connection mode, the function always returns FALSE. If the connection is established, then the CONNECTED event is created Any other value - at first the synchronous mode is used, in case of fault - asynchronous mode.
connect_attempts	Number of connection attempts

### 2.2.3.4.5 SendData4

This function is used to send CUserNetObject. Its purpose is to send raw data.

```
BOOL SendData4(LPCTSTR id, int nIdent, BYTE *pBuffer, DWORD dwSize);
```

Parameter	Description
id	Core connection ID

nIdent	Data UID
pBuffer	Transmitted data
dwSize	The size of data array

#### 2.2.3.4.6 SendFile

The function is used to send a file.

```
BOOL SendFile(LPCTSTR id, LPCTSTR file_from, LPCTSTR file_to)
```

Parameter	Description
id	Core connection ID
file_from	Address to send file from.
file_to	Address to send file to.

#### 2.2.3.4.7 GetMsg

The function is used to retrieve incoming messages that are queued if the Callback function is not specified.

```
BOOL GetMsg(LPTSTR msg, DWORD& cb)
```

Parameter	Description
msg	Incoming message
cb	Message length

### 2.2.4 Sent Message Syntax

#### 2.2.4.1 Message Syntax

Messages sent to the core have the following syntax:

**CORE||DO\_REACT|source\_type<OBJECT TYPE>,source\_id<OBJECT ID>,action<ACTION> [ ,params<NO. OF PARAMETERS>,param0\_name<PARAMETER NAME\_0>,param0\_val<PARAMETER VALUE\_0>]**

Below is the syntax of messages that contain two parameters.

**CORE||DO\_REACT|source\_type<OBJECT TYPE>,source\_id<OBJECT ID>,action<ACTION>,params<2>,param0\_name<PARAMETER NAME\_0>,param0\_val<PARAMETER VALUE\_0>,param1\_name<PARAMETER NAME\_1>,param1\_val<PARAMETER VALUE\_1>**

The message parameters are described in the table below.

Parameter	Description
source_type<obj>	Object type (see the DDI file ( [OBJTYPE] section) )
source_id<id>	The object ID set when creating the object in Intellect (see Intellect's settings tree)
action<react>	Action (see the DDI file (the [REACT] section) )
params<number>	The number of parameters passed, in decimal format
param0_name<str1>	Parameter name
param0_val<str2>	Parameter value

 **Note:**

For working with DDI files, we recommend using the ddi.exe utility (see Section [Using the ddi.exe Tool to Work with DDI files](#)).

**Example.** Sending a message to switch the telemetry to preset mode 4.

**CString msg=**

**“CORE||DO\_REACT|**

**source\_type<TELEMETRY>,source\_id<1.1>,action<GO\_PRESET>,params<2>,param0\_name<preset>,param0\_val<4>,param1\_name<tel\_prior>,param1\_val<2>”;**

**SendMsg(id,msg);**

## 2.2.4.2 Message Syntax (port 900)

Messages sent to port 900 are passed to the video subsystem directly; for this reason, such messages have a different syntax.

Messages sent to the video subsystem have the following syntax:

**OBJECT TYPE|OBJECT ID|ACTION [|PARAMETER<VALUE>]**

Below is the syntax of messages that contain n parameters.

**OBJECT TYPE|OBJECT ID|ACTION [|PARAMETER 1<VALUE>,PARAMETER 2<VALUE>,....,PARAMETER N<VALUE>]**

 **Attention!**

Port 900 may only be used to manage objects of the GRABBER, CAM, or MONITOR types.

The message parameters are described in the table below.

Parameter	Description
Object type	Object type (GRABBER, CAM, or MONITOR)
Object ID	The object ID set during creation of the object in Intellect
Action	Action (command)
Parameter <Value>	Parameter name. The value is enclosed by angle brackets.

**Example 1.** Setting camera 1 to recording mode.

**CString msg = "CAM|1|REC";**

**SendMsg (id,msg);**

**Example 2.** Saving video from all cameras to local disk C.

**CString msg = "GRABBER|1|SET\_DRIVES|drives<C:\>";**

**SendMsg(id,msg);**

**Note.**  
The **SET\_DRIVES** command includes the ID of any of the video capture cards created in the system.

**Note.**  
The **SET\_DRIVES** command does not change the video archiving settings set in the system.

### 2.2.4.3 Using the Event and React classes

For working with messages, you may use the classes provided: *Event* and *React*, declared in the msg.h file.

Example of using the react class:

A message composed without using the classes	A message composed using the React class
<pre>CString msg = "CORE  DO_REACT source_type&lt;TELEMETRY&gt;,source_id&lt;1.1&gt;, action&lt;GO_PRESET&gt;,params&lt;2&gt;,param0_name&lt;preset&gt;,param0_val&lt;4&gt;, param1_name&lt;tel_prior&gt;,param1_val&lt;2&gt;"; SendMsg(id,msg);</pre>	<pre>React react("TELEMETRY", "1.1", "GO_PRESET"); react.SetParamInt("preset",4); react.SetParamInt("tel_prior",2); SendMsg(id,react.MsgToString().c_str());</pre>

**Note:**  
The msg.h and msg.cpp files are located in the Misc folder which is in the archive on page [Intellect Software Integration Guide \(HTTP API, IIDK, ActiveX\)](#).

## 2.2.5 Examples of Managing System Objects

### 2.2.5.1 Adding, Updating, and Deleting System Objects

**On the page:**

- [Adding a User to a Department](#)
- [Adding and Deleting a Video Capture Card](#)

System objects are added, updated, and deleted by the following commands:

1. **CORE||CREATE\_OBJECT** – creates a new object.
2. **CORE||UPDATE\_OBJECT** – updates an existing object or creates a new one.
3. **CORE||DELETE\_OBJECT** – deletes an object.

### 2.2.5.1.1 Adding a User to a Department

Below is a message that adds the specified user to the specified department, with the specified parameters:

```
CORE||CREATE_OBJECT|objtype<PERSON>,objid<12>,parent_id<1>,name<John Doe>,core_global<0>,params<11>,param0_name<facility_code>,param0_val<122>,param1_name<card>,param1_val<1234>,param2_name<pin>,param2_val<>,param3_name<comment>,param3_val<HR Department Head>,param4_name<is_locked>,param4_val<0>,param5_name<is_apb>,param5_val<0>,param6_name<level_id>,param6_val<*>,param7_name<person>,param7_val<>,param8_name<_creator>,param8_val<1>,param9_name<expired>,param9_val<>,param10_name<temp_card>,param10_val<>
```

### 2.2.5.1.2 Adding and Deleting a Video Capture Card

If an object is not present in the system, add that object with the **UPDATE\_OBJECT** command (the system must not have an object with a type and ID equal to objtype and objid, respectively).

```
CORE||UPDATE_OBJECT|objtype<GRABBER>,objid<12>,core_global<0>,parent_id<SLAVAXP>,name<Frame grabber 1>,params<5>,param0_name<format>,param0_val<NTSC>,param1_name<mode>,param1_val<1>,param2_name<chan>,param2_val<2>,param3_name<type>,param3_val<FX 4>,param4_name<resolution>,param4_val<0>
```

Having received the following message, the system changes the name of an existing object:

```
CORE||UPDATE_OBJECT|objtype<GRABBER>,objid<12>,core_global<0>,parent_id<SLAVAXP>,name<Card 2>
```

To delete an object and all of its child objects, use the **DELETE\_OBJECT** command:

```
CORE||DELETE_OBJECT|objtype<GRABBER>,objid<12>
```

## 2.2.5.2 Working with the System in the Multiuser Mode

The remote computer must install and be running Intellect (**Client** installation version) in order to exchange messages with the Server.

If users have been created and access rights have been configured in Intellect, any message that requires a response from the system core must contain the **receiver\_id<ID>** parameter, where ID is the ID of the **IIDK Interface** in the system.

```
CORE||GET_CONFIG|objtype<CAM>,objid<1>,receiver_id<1>
```

**// Returns the parameters of the Camera 1 object**

To get the user ID and user's permissions DI by username and password, use the CHECK\_USER function. Examples of using:

```
CORE||CHECK_USER|password<1>,login<1>
```

```
CORE||CHECK_USER|pass_key<1373503546>,login<1> (crc32 from DB)
```

```
CORE||CHECK_USER|md5<bf03b1605e3c83978514f2a6546eef50> (md5 from DB)
```

Response:

```
ACTIVEX|1|USER_RIGHTS|rights_id<1>,user_id<1>
```

If the password is incorrect, the response comes with a delay of 1 second.

### 2.2.5.3 Determining Computers Where Intellect was Unloaded (via Port 1030)

If Intellect is unloaded, the callback function receives a message with an **action** parameter value of **DISCONNECTED**:

```
ACTIVEX|12|EVENT|SOCKET<>,MMF<>,objaction<DISCONNECTED>,TRANSPORT_TYPE<MMF>,core_global<1>,action<DISCONNECTED>,module<slave.exe>,objtype<SLAVE>,__slave_id<SLAVAXP.12>,objid<SLAVAXP>,owner<SLAVAXP>,TRANSPORT_ID<1111>,time<12:41:16>,date<23-09-02>
```

The message contains the name of the computer on which *Intellect* was unloaded and the date and time

### 2.2.5.4 Redirecting Video Cameras to the Monitor

After receiving the following message, the system deletes all cameras from the monitor and calls the specified video camera:

**CORE||DO\_REACT|**

**source\_type<MONITOR>,source\_id<1>,action<REPLACE>,params<4>,param0\_name<slave\_id>,param0\_val<SLAVA>,param1\_name<cam>,param1\_val<1>,param2\_name<control>,param2\_val<1>,param3\_name<name>,param3\_val<>**

If connected via port 900, the above action is performed by using the following message:

**MONITOR|1|REPLACE|slave\_id<SLAVA>,cam<1>,control<1>**

### 2.2.5.5 Obtaining Object Parameters (via Port 1030) GET\_CONFIG

An example of use of the **GET\_CONFIG** command is given below:

**CORE||GET\_CONFIG|objtype<CAM>,objid<1>**

The returned message contains all the parameters of the specified object:

**ACTIVEX|12|OBJECT\_CONFIG|**

**rec\_priority<0>,mask0<>,decoder<0>,mask1<>,flags<>,mask2<>,compression<3>,sat\_u<5>,mask3<>,proc\_time<>,hot\_rec\_period<>,mask4<>,telemetry\_id<>,manual<1>,region\_id<1.1>,contrast<5>,md\_mode<0>,md\_size<5>,audio\_type<>,pre\_rec\_time<0>,config\_id<>,bright<7>,alarm\_rec<0>,audio\_id<>,rec\_time<>,hot\_rec\_time<2>,activity<>,mux<0>,parent\_id<1>,objtype<CAM>,type<>,\_\_slave\_id<SLAVAXP.12>,objid<1>,name<Camera 1>,objname<Camera 1>,color<1>,priority<0>,md\_contrast<5>**

**Note:**

To obtain the configuration of all the objects of the specified type, remove the **objid** parameter.

Example. Get information about user by the identifier.

**CORE||GET\_CONFIG|objtype<PERSON>,objid<1>**

The response is the message with parameters containing necessary information, including user name, card number etc.:

**ACTIVEX|1|OBJECT\_CONFIG|**

**pnet3\_sound<0>,galaxy\_dual\_focus<0>,auto\_pass\_type<>,galaxy\_pin\_change<0>,external\_id<>,card\_date<26.05.2017 10:57:06>,galaxy\_tag\_link<0>,rubeg8\_zone\_id<>,levels\_times<>,expired<>,hid\_escort\_id<>,objtype<PERSON>,level2\_id<>,galaxy\_group\_choice<0>,who\_level<>,hid\_use\_extended\_access<0>,visit\_purpose<>,card<1234>,email<>,galaxy\_timer\_schedule<0>,galaxy\_menu\_option<0>,aiu\_holiday<0>,area\_id<>,aiu\_alarm<0>,objname<User 1>,surname<>,who\_card<>,auto\_brand<>,pnet3\_alarm<0>,card\_loss<0>,facility\_code<432>,galaxy\_temp\_code<0>,post<>,when\_area\_id\_changed<>,drivers\_licence<>,bolid\_in\_device<0>,pnet3\_accs\_counter<0>,temp\_levels\_times<>,temp\_card<>,pnet3\_no\_entry<0>,location<>,temp\_level\_id<>,patronymic<>,teleph\_work<>,department<>,galaxy\_keypad<0>,\_TRANSPORT\_ID<>,finished\_at<>,aiu\_ksd\_type<>,all\_param<>,galaxy\_template<0>,tabnum<>,parent\_id<1>,pur<>,galaxy\_duress<0>,pnet3\_no\_exit<0>,galaxy\_dual<0>,hid\_pin\_exempt<0>,pnet3\_counter<0>,whence<>,schedule\_id<>,hid\_enable\_pin\_commands<0>,galaxy\_dual\_access<0>,pnet3\_block<0>,passport<>,person<>,galaxy\_menu\_choice<0>,flags<0>,auto\_number<>,phone<>,pin<>,rubeg8\_AccessToBCPTTimeZoneNumber<>,begin\_temp\_level<>,pnet3\_master<0>,aiu\_mark<0>,end\_temp\_level<>,visit\_birthplace<>,galaxy\_menu\_level<>,visit\_document<>,pnet3\_guard<0>,pnet3\_black<0>,aiu\_kso\_type<>,is\_apb<0>,name<User 1>,pnet3\_temp<0>,started\_at<>,level\_id<>,\_marker<>,bolid\_user\_type<>,owner\_person\_id<>,card\_type<>,is\_active\_temp\_level<0>,begin<>,hid\_line\_tag<>,guid<{5B358685-E041-E711-BCC6-DA0AE28E0C17}>,pnet3\_guest<0>,is\_locked<0>,objid<1>,marketing\_info<>,comment<>,aiu\_vpu\_arm<0>,visit\_reg<>,bolid\_in\_pku<0>,pnet3\_2cards\_mask<0>**

**Note.**

User data can also be received via direct request to *Intellect* software database from the OBJ\_PERSON table. In this case you can select a user by card number or other parameters. See more info on *Intellect* software database operation in [Administrator's Guide](#), the [Appendix 4. INTELLECT™ software database management](#).

### 2.2.5.6 Obtaining Information on Object States GET\_STATE and GET\_LIST

To obtain information on the state of an object, use the **GET\_STATE** command:

**CORE||GET\_STATE|objtype<CAM>,objid<1>**

The following string is returned:

**ACTIVEV|12|OBJECT\_STATE|objtype<CAM>,\_\_slave\_id<SLAVAXP.12>,objid<1>,state<DISARM\_DETACHED>**

The state of the specified object is represented by the **state** parameter, which takes values from the set of states that are specified in the object's DDI file.

If connected via port 900, requests for object states are performed through the **GET\_LIST** command:

**CAM||GET\_LIST**

**Note:**

Regardless of whether an object ID is specified, the command returns the states of all objects of the specified type.

The returned message has the following format:

**CAM|1|SETUP|rec\_priority<0>,is\_armed<0>,is\_recorded<0>, bt<0>, slave\_id<SLAVAXP>, compression<3>,sat\_u<5>, proc\_time<0>, hot\_rec\_period<0>, manual<1>, telemetry\_id<>, is\_detached<1>, contrast<5>, md\_size<5>,md\_mode<0>, is\_alarmed<0>, audio\_type<>, pre\_rec\_time<0>, bright<7>, audio\_id<>, rec\_time<0>, alarm\_rec<0>, hot\_rec\_time<2>, mux<0>, parent\_id<1>, \_\_slave\_id<SLAVAXP>, priority<0>, mask<>, color<1>,md\_contrast<5>, is\_ring<1>, fs\_error<0>**

The message presents the states as follows: **is\_state<val>**, where **state** is an object state (see the DDI file); and **val** equals 1 if the object is in this state, 0 otherwise.

**Note.**

The **is\_ring<>** parameter shows whether loop recording is performing or not. The **fs\_error** parameter equals 1 when there was an archive recording error (e.g. failed to delete folder for loop recording).

### 2.2.5.7 Showing Information Messages. SET\_STATE

To show an information message on the display of Intellect's main control panel, use the SET\_STATE command:

**CORE||SET\_STATE|name<POS 1>,value<Can't open port COM4>**

The figure below shows the result of handling the message by the system.



The message is removed from the display as follows:

**CORE||SET\_STATE|name<POS 1>,value<>**

### 2.2.5.8 Live and archived video

To get live video from Camera 1 send **CAM|1|START\_VIDEO|compress<1>** message to port 900.

Here compress<> is compression ratio, from 0 to 5. Video frames will be received as a response to this message. The example of

how to process incoming frames is given in demo kit available for download at the page of [Intellect Software Integration Guide \(HTTP API, IIDK, ActiveX\)](#).

To get archived video from Camera 1 send **CAM|1|ARCH\_FRAME\_TIME|time<dd-mm-yy HH:MM:SS.FFF>** (to specify start time for viewing the archive) or **CAM|1|PLAY|compress<>** (to get archived video. Archived video is handled the same way as live video) messages to port 900.

In order to get the full list of time intervals with video recordings for exact date, send **CAM|id|ARCH\_GET\_INTERVALSREC|date<>** message to port 900.

The date<> parameter can take the date<dd-mm-yy> value or it can be left blank. In the first case time intervals for specified date will be requested, in the second – dates for which there is an archive.

As a result the **Event: CAM|id|SET\_INTERVALSREC|intervals<>,date<>,timezone<>** message is received.

The value of intervals<> parameter looks like this: intervals<begin1 end1\nbegin2 end2...\nbeginN endN|date1\ndate2...\ndateN\n>

The time of beginning and ending are one blank separated (0x20 code), intervals are line break separated '\n'(0x0A code).

- begin1, begin2, ... beginN – time of interval beginnings in the HH:MM:SS format (returns if the exact date was requested).
- end1, end2, ... endN – time of interval endings in the HH:MM:SS format (returns if the exact date was requested).
- date1, date2, ... dateN – dates at which there are recordings in the archive (returns if the date field in the request is blank or there is no such field).

date<dd-mm-yy> parameter represents date for which the intervals were requested or blank value (date<>) if dates for the entire period were requested.

timezone<> shows time shift on the client (IIDK) relative to Server time, in minutes. Examples:

- If Server is in -1 UTC time zone, the response to the CAM|1|ARCH\_GET\_INTERVALSREC| command will have parameter timezone<60>
- If Server is in +3 UTC time zone, the response to the CAM|1|ARCH\_GET\_INTERVALSREC| command will have parameter timezone<-180>

## 2.2.5.9 Telemetry control via IIDK

Telemetry is controlled via IIDK using simple reactions described in the TELEMETRY section of Programming guide, for instance:

### CORE||DO\_REACT|

**source\_type<TELEMETRY>,source\_id<1.1>,action<LEFT>,params<1>,param0\_name<tel\_prior>,param0\_val<3>** – message sent to port 1030 in order to rotate camera lens left with high priority.

**TELEMETRY|1.1|LEFT|speed<2>,tel\_prior<3>** – reaction to port 1030 in order to rotate camera lens left with high priority at an average speed.

## 2.2.5.10 Map layer operations

The command for setting the parameter and position of **Camera 1** object icon is run in one of the following ways:

1. Sending a message to port 1030 **CORE||DO\_REACT|source\_type<MAPLAYER>,source\_id<1>,action<CUSTOMIZE\_OBJECT>,params<7>,param0\_name<x>,param0\_val<200>,param1\_name<y>,param1\_val<200>,param2\_name<objtype>,param2\_val<CAM>,param3\_name<objid>,param3\_val<1>,param4\_name<a>,param4\_val<90>,param5\_name<w>,param5\_val<70>,param6\_name<h>,param6\_val<80>**

Where *x*, *y*, *w* and *h* are the coordinates and size of the object icon on the map.

*a* is a tilt angle of icon.

2. Sending a reaction to port 1030 **MAPLAYER|1|CUSTOMIZE\_OBJECT|x<200>,y<200>,objtype<CAM>,objid<1>,a<90>,w<70>,h<80>**

Layer 1 is shown in the interactive map window using one of the following ways:

1. Sending a message to port 1030: **CORE||DO\_REACT|source\_type<MAPLAYER>,source\_id<1>,action<ACTIVATE>**
2. Sending a reaction to port 1030: **MAPLAYER|1|ACTIVATE**

### 2.2.5.11 Obtaining info on core queues with GET\_QUEUE\_INFO command

Use the GET\_QUEUE\_INFO command to request info about the queues in the Intellect core:

#### CORE||GET\_QUEUE\_INFO

**Note.**

The receiver\_id parameter may be specified if there are several **IIDK Interface** objects in the system – see [Working with the System in the Multiuser Mode](#).

The response is the string like this:

**ACTIVEX|11|QUEUE\_INFO|thread2<0>,thread1<0>,thread0<0>,posted\_events<0>,\_TRANSPORT\_ID<>,server\_reacts<0>,posted\_reacts<0>,events\_inwork<0>,coremanager\_events<0>,thread3<0>**

The response parameters correspond to the information displayed in the **Queue statistics** tool (shows on Alt+F2). Parameters description:

**threadN<>** – number of items in the queue of the thread N.

**posted\_events<>** – number of incoming events.

**posted\_reacts<>** – number of reactions currently being processed.

**coremanager\_events<>** – number of events to send.

**server\_reacts<>** – number of reactions to send.

**events\_inwork<>** – number of events currently being processed.

## 3 CamMonitor.ocx ActiveX Control

### 3.1 General description of CamMonitor.ocx component of ActiveX

#### On the page:

- [General information](#)
- [Requirements to developers](#)

#### 3.1.1 General information

CamMonitor.ocx is the component of ActiveX that is similar in every way to the **Video monitor** interface object. It allows you to manage cameras, view the archive, etc.

CamMonitor.ocx component supports operation in the demo mode.

#### 3.1.2 Requirements to developers

To use CamMonitor.ocx you will need:

1. The knowledge of any programming language that supports using the Component Object Model (COM);
2. Basic knowledge of Win32/Win64 programming;
3. Programming environment that supports OCX files.

✔ [Requirements for software which is used while integrating](#)

### 3.2 How to install CamMonitor.ocx

#### ⚠ Important!

It is not recommended to install *Intellect* and CamMonitor.ocx on the same computer. If it is required, then their versions are to be the same, otherwise CamMonitor.ocx operation is not guaranteed.

Use the CamMonitorInstaller.exe file (stored in the <Intellect installation directory>\Redist\CamMonitor folder) to install CamMonitor.ocx. Both 32-bit and 64-bit versions of this component are available. The installation files of components of different bit count are stored in the corresponding folders (x86 and x32 correspondingly).

If *Intellect* software is installed on the computer, then the CamMonitor.ocx file is stored in the <Intellect installation directory>\Modules\ folder when installing the 32-bit version and it is stored in the <Intellect installation directory>\Modules64\ folder when installing the 64-bit version.

If *Intellect* software is not installed, then the 32-bit component is installed in the c:\Program Files (x86)\ITV VideoPlayer\Modules\ folder and the 64-bit component is installed in the c:\Program Files\ITV VideoPlayer x64\Modules64\ folder.

There is standard registration of CamMonitor.ocx as ActiveX component at the stage of installation.

CamMonitorInstaller.exe installs the required files for all users.

Besides the library itself, CodecPack driver pack and ITV VideoPlayer utility are installed. ITV VideoPlayer utility uses the CamMonitor.ocx component and enables viewing the archive from the selected camera. By default this utility is installed in the C:\Program Files\ITV VideoPlayer\ folder. The utility interface looks like one of Converter.exe, but some features of Converter.exe (not dealing with viewing the archive) are not available. This utility can be used to check if CamMonitor.ocx is installed correctly.

### 3.3 CamMonitor.ocx parameters

#### On the page:

- [CamMenuOptions](#)
- [CamMenuProcessingOptions](#)
- [CamButtonsOptions](#)
- [MainPanelOptions](#)
- [KeysOptions](#)
- [OverlayMode](#)
- [How to use parameters](#)

The parameters used for setting the CamMonitor component are presented in this chapter: elements to be shown as well as the overlay mode.

All parameters are *long* integers.

The values of parameters used for interface setup are enlisted in the tables and formed in a way that one integer only is represented in binary notation. To set the value of a parameter, combine the values of parameters using the XOR operation. You'll get the number the positions of which in binary notation represent the interface elements that are to be shown and those to be hidden. See [How to use parameters](#) section.

The OverlayMode parameter differs from others: it possesses values from 0 to 2 and its value sets the overlay mode.

#### 3.3.1 CamMenuOptions

**CamMenuOptions** : long

Allows setting the feature menu of the camera.

One or more checkboxes can be set checked.

Available values:

Value	Information
#define MENU_ENABLE_OPTION 0x00000001	Deprecated. See BUTTON_MENU_ENABLE_OPTION
#define MENU_ARM_ENABLE_OPTION 0x00000002	Show the <b>Arm</b> option
#define MENU_REC_ENABLE_OPTION 0x00000004	Show the <b>Start recording</b> option
#define MENU_CAMS_ENABLE_OPTION 0x00000008	Show the <b>Camera</b> option
#define MENU_TITLES_ENABLE_OPTION 0x00000010	Show the <b>Show titles</b> option
#define MENU_PROCESSING_ENABLE_OPTION 0x00000020	Show the <b>Processing</b> option
#define MENU_EXPORT_ENABLE_OPTION 0x00000040	Show the <b>Export</b> option

#### 3.3.2 CamMenuProcessingOptions

**CamMenuProcessingOptions** : long

Allows setting the **Processing** menu in the feature menu of the camera.

One or more checkboxes can be set checked:

Available values:

Value	Information
#define MENU_PROCESSING_DEINTERLACE_ENABLE_OPTION 0x00000001	Show the <b>Deinterlacing</b> option
#define MENU_PROCESSING_ZOOM_ENABLE_OPTION 0x00000002	Show the <b>Zoom-in</b> option <i>Note. If this option is disabled, the <b>Processing</b> → <b>Zoom</b> menu item is not shown, but zooming with mouse wheel is still available.</i>
#define MENU_PROCESSING_CONTRAST_ENABLE_OPTION 0x00000004	Show the <b>Contrast</b> option
#define MENU_PROCESSING_MASK_ENABLE_OPTION 0x00000008	Show the <b>Detector mask</b> option
#define MENU_PROCESSING_SHARP_ENABLE_OPTION 0x00000010	Show the <b>Sharpen</b> option

### 3.3.3 CamButtonsOptions

**CamButtonsOptions** : long

Set up displaying the buttons of the CamMonitor component.

One or more checkboxes can be set checked.

Available values:

Value	Information
#define BUTTON_MODE_ENABLE_OPTION 0x00000100	Show the Archive button
#define BUTTON_TIME_ENABLE_OPTION 0x00000002	Show time
#define BUTTON_NAME_ENABLE_OPTION 0x00000004	Show camera name
#define BUTTON_MENU_ENABLE_OPTION 0x00000008	Show the Menu button
#define BUTTON_RAYS_ENABLE_OPTION 0x00000010	Not used
#define BUTTON_MICS_ENABLE_OPTION 0x00000020	Not used

### 3.3.4 MainPanelOptions

**MainPanelOptions** : long

Set up displaying the CamMonitor panel.

One or more checkboxes can be set checked.

Available values:

Value	Information
#define MAIN_PANEL_ENABLE_OPTION 0x00000001	Show the panel

#define MAIN_PANEL_ENABLE_SCREEN_BUTTON 0x00000010	Show the <b>Screens</b> button (see <a href="#">Windows layout on the monitor</a> ).
#define MAIN_PANEL_ENABLE_BOOKMARK_BUTTON 0x00000020	Show the <b>Create a bookmark</b> button (see <a href="#">Create a bookmark</a> ).
#define MAIN_PANEL_ENABLE_BOOKMARK_REVIEW_BUTTON 0x00000040	Show the <b>List of bookmarks</b> button (see <a href="#">List of bookmarks</a> ).
#define MAIN_PANEL_ENABLE_AVIEXPORT_BUTTON 0x00000080	Show the <b>Background export</b> button (see <a href="#">The AviExport utility</a> ).

### 3.3.5 KeysOptions

**KeysOptions** : long

It allows setting control over the component using the keyboard and mouse.

One or more checkboxes can be set checked.

Available values:

Value	Description
#define KEYS_ENABLE_OPTION 0x00000001	Enables control over the CamMonitor component using the hotkeys available for Video Monitor (see <a href="#">Video Monitor</a> ).
#define TELEMETRY_DISABLE_OPTION 0x00000002	Disables Telemetry control using the CamMonitor component (see <a href="#">Telemetry control</a> ).
#define ARCH_DELETE_ENABLE_OPTION	Enables archive recordings deletion from the recordings list (see <a href="#">Deleting video recordings from the archive</a> ).
#define ARCH_PROTECT_ENABLE_OPTION	Enables rewrite protection of the archive recordings from the recordings list (see <a href="#">Protection of separate record and disable of protection</a> ).

### 3.3.6 OverlayMode

**OverlayMode** : long

Set the overlay mode.

Available values:

Value	Information
0	Overlay is not in use
1	Overlay 1
2	Overlay 2

### 3.3.7 How to use parameters

```

DWORD options = CamMonitor1->CamMenuOptions;
options = options^MENU_CAMS_ENABLE_OPTION^MENU_ARM_ENABLE_OPTION^MENU_REC_ENABLE_OPTION;
CamMonitor1->CamMenuOptions = options;
CamMonitor1->CamMenuProcessingOptions ^= MENU_PROCESSING_MASK_ENABLE_OPTION;

```

## 3.4 CamMonitor.ocx methods

### On the page:

- [Connect](#)
- [ShowCam](#)
- [DoReactMonitor](#)
- [RemoveAllCams](#)
- [IsConnected](#)
- [GetCurlp](#)
- [SendRawMessage](#)
- [Disconnect](#)
- [SetCallBackOptions](#)
- [SetParam](#)

### 3.4.1 Connect

**Connect**(BSTR **ip**, BSTR **login**, BSTR **password**, BSTR **arch\_password**, long **param**, long **port**) set up a connection to the Server/Video Gate/Backup Archive.

- BSTR **ip** – IP address of the Video server;
- BSTR **login** – login to connect to the Server (can be blank);
- BSTR **password** – password to set up a connection to the Video server (can be blank);
- BSTR **arch\_password** – password to access the archive (i.e. admin password, can be blank);
- long **param** – Server role. The parameter is mandatory.
  - 0 – video server;
  - 1 – backup archive;
  - 2 – videogate;
- long **port** – port to connect Video server.
  - if 0, 1 or 2 are passed, the connection is established with port 900, 901 or 902 correspondingly;
  - if 100 is passed, the connection is with port 10504;
  - if any other value passed, the connection is with port number "port + 20000". For example, if port=900, the connection is established with server port 20900.

The connection to Server is set up **asynchronously**.

#### Important!

If login and password are not specified at Connect() method call, all cameras are viewable in the control. It is to be considered when developing third-party application if access privileges are relevant.

### 3.4.2 ShowCam

**ShowCam**(long **cam\_id**, long **compress**, long **show**) shows/hides camera on the monitor.

- long **cam\_id** – camera ID
- long **compress** – level of video compression 0-5 (for local camera =0). If set to -1, video stream is displayed directly from the camera without compression.
- long **show** – checkbox: show/hide camera (1/0)

### 3.4.3 DoReactMonitor

**DoReactMonitor**(BSTR **react\_string**) – control over the monitor/cameras

- BSTR **react\_string** – reaction string view

#### How to create react\_string:

```
react_string = "MONITOR|ARCH_FRAME_TIME|cam<3>,date<dd-mm-yy>,time<hh:mm:ss>";
CamMonitor1->DoReactMonitor(react_string);
```

**The result of calling the function with the parameter:** camera 3 will be in the archive mode and the archive will be positioned to date «dd-mm-yy» and time «hh:mm:ss» (date and time are to be set in this format only).

The mode parameter takes the following values:

0 – video gate if it's specified (otherwise, video server).

1 – video server.

2 – long-time archive.

“MONITOR|<id ignored>|ARCH\_FRAME\_TIME|...”

#### Note:

Positioning accuracy can be specified in milliseconds, for instance:

```
DoReactMonitor("MONITOR|ARCH_FRAME_TIME|cam<3>,date<02-10 05>,time<12:12:22.345>
```

**Example.** Show 2nd stream from camera 14 on Monitor 1:

```
"MONITOR|1|ADD_CAM|cam<14>,cam_id<14>,compress<1>,stream_id<14.2>"
```

**Exapmle.** Set fps = 1 when viewing archive from Camera 11

```
"MONITOR||CAM_PARAMS|cam<11>;arch_fps<1>"
```

### 3.4.4 RemoveAllCams

**RemoveAllCams() : long** – remove all cameras from the monitor

### 3.4.5 IsConnected

**IsConnected() : boolean** – method shows if the Video server is connected or disconnected.

### 3.4.6 GetCurlp

**GetCurlp() : BSTR** – returns the IP address of Server specified when calling **Connect**.

### 3.4.7 SendRawMessage

**SendRawMessage(BSTR msg)** – sends the command to be executed to Video server.

- BSTR **msg** – command string view

#### How to call a function:

```
m_Cam.SendRawMessage("CAM|1|REC");
```

```
m_Cam.SendRawMessage("CAM|1|REC_STOP");
```

```
m_Cam.SendRawMessage("CAM|1|ARM");
```

```
m_Cam.SendRawMessage("CAM|1|DISARM");
```

### 3.4.8 Disconnect

**Disconnect()** – disconnect from the Video server.

### 3.4.9 SetCallbackOptions

**SetCallbackOptions**(int **cam\_id**, int **options**) – sets parameters of getting video from camera.

- int **cam\_id** – camera ID (number).
- int **options** – options. The possible values of the **options parameter are:**
  - WithoutVideoFrame = 0x00 – do not send frames from the video module.
  - WithVideoFrame = 0x01 – send frames from the video module.
  - WithExtendedParams = 0x02 – get frames with extended parameters (time, fps, subtitles).
  - WithInformationLayout = 0x04 – display video in the window with control elements (context menu).
  - WithCompressedData = 0x08 – display video in the native format without decompression (if any).
  - WithoutDecode = 0x10 – disable video decoding on the server.
  - WithoutSubtitles=0x20 – disable subtitles.

#### Note

The options parameter is created the same as parameters of the CamMonitor.ocx component – see [CamMonitor.ocx parameters](#).

### 3.4.10 SetParam

**SetParam**(BSTR **param\_name**, BSTR **param\_value**) - sets the number of camera windows in CamMonitor.

- BSTR **param\_name** - a string representation of the length or width.
- BSTR **param\_value** - the number of camera windows.

**How to call a function:**

```
m_cam.SetParam("monitor_ch", m_NH);
m_cam.SetParam("monitor_cw", m_NW);
```

## 3.5 CamMonitor.ocx events

**OnCamListChange** (long **cam\_id**, long **action**) – occurs when there is connection with the Server or the number of cameras on the Server changes.

- long **cam\_id** – camera ID.
- long **action** equals 1, if camera with **id == cam\_id** exists, otherwise **action == 0**.

This event occurs as many times as there are cameras on the Server. The negative value of the **cam\_id** parameter (**cam\_id < 0**) shows that **OnCamListChange** is not called.

If there are 3 cameras (1, 2, 3) on the Server, then the following events will occur one after another:

```
CamListChange(1,1)
```

CamListChange(2,1)

CamListChange(3,1)

CamListChange(-1,1)

**Example:**

Show the camera with cam\_id =2 with **compress =1** compression level;

```
CamMonitor1CamListChange(long cam_id, long action)
{
    if(cam_id == -1)
    {
        CamMonitor1->ShowCam(2,1,1);
    }
}
```

## 4 Intellect HTTP API

### 4.1 General information on HTTP API

HTTP API is represented by web2 module (*Web-server 2.0*).

**Note.**

See [Administrator's Guide, Configuring the server for the clients connection via the Web-server 2.0 module](#) section.

HTTP API allows the following features:

1. Get information about interactive maps: map list, map name, map layer list, layer parameters, layer background image, information about the list of points and an individual point on the layer (see [Map](#)).
2. Get information about object classes created on the Server, a list of states for the object class and information about status, icons for a specific state (see [Object classes](#)).
3. Get a list of objects created on the server, information about the individual object, the state of the object, the list of available actions with the object (see [Objects](#)).
4. Receive events from the Server both separately and by blocks (see [Getting events](#)).
5. Send commands to the server (see [Sending commands to server](#)).
6. Run macros (see [Macros](#)).
7. Work with video: get frames, request configuration, receive live and archive video, manage recording, arm and disarm cameras, manage telemetry (see [Video](#)).
8. Use notification systems to subscribe an application to APNS messages (see [Notification](#)).
9. Get live and archive sound (see [Sound](#)).
10. Send events and reactions to the core of the Intellect software (see [Sending reactions and events to Intellect using HTTP request](#)).

The following notation is used in the examples shown in this section:

- Port stands for port number. The default **Web-server 2.0** module port is 8085. Specifying port in HTTP API commands is mandatory.
- /web2 – web context where the web2 app operates. This is the web-app context.

Further the description will be omitted when query action is clear in the context.

**Important!**

URL, id of objects and file extension are case-sensitive.

**Note.**

Date and time are specified in RFC 3339 format, see details at <http://www.ietf.org/rfc/rfc3339.txt>

### 4.2 Getting events

Connection is not lost and events are always received.

action – type of event. Possible values: create, delete, update.

The fields below are optional:

objectId - id of object that is the source of event (always with update, delete, create).

state – id of a new object state (always with create. If the state has not changed, then there is no update state).

x, y – new coordinates (if changed).

**Query:**

`http://example.com:[port]/web2/secure/feed/`

**Samples of response:**

```
<message>
  <action>update</action>
  <objectId>CAM:1</objectId>
  <state>disconnected</state>
</message>
```

```
<message>
  <action>state</action>
  <objectId>CAM:1</objectId>
  <x>10.0</x>
  <y>123.9</y>
</message>
```

```
<message>
  <action>state</action>
  <objectId>CAM:1</objectId>
  <state>connected</state>
  <x>300.8</x>
  <y>670</y>
</message>
```

```
<message>
  <action>state</action>
  <objectId>CAM:1</objectId>
  <x>100</x>
  <y>100</y>
</message>
```

```
<message>
  <action>ping</action>
</message>
```

#### 4.2.1 Getting events of video subsystem in blocks

[http://example.com:\[port\]/web2/secure/events/](http://example.com:[port]/web2/secure/events/)

**Parameters:**

**from** – the oldest date of message search period. 2012-12-27T15%3A19%3A16.000%2B04%3A00

**to** – the latest date of message search period. 2012-12-27T15%3A19%3A16.000%2B04%3A00

**count** – maximum number of messages in reply [1, 200]. On default – 20. Server can return more messages if there are few messages in the database.

**objectId** – object id (CAM:1, GRAY:5 etc.). If parameter is not specified, events are returning for all.

Return codes:

200 - OK  
 400 - invalid parameter (e.g. date format)  
 500 - error  
 503 - error of core connection  
 504 - time-out (core failed to return data within 2000 milliseconds)

### Examples of reply

#### XML:

```
<events>
  <event>
    <description>Record is on</description>
    <id>{E56B09A0-1A50-E211-840E-005056C00008}</id>
    <objectId>CAM:1</objectId>
    <ts>2012-12-27T15:43:27+04:00</ts>
  </event>
  <event>
    <description>Record is off</description>
    <id>{4482F63F-1A50-E211-840E-005056C00008}</id>
    <objectId>CAM:1</objectId>
    <ts>2012-12-27T15:40:50+04:00</ts>
  </event>
  <event>
    <description>Record is off</description>
    <id>{35D4BE3E-1750-E211-840E-005056C00008}</id>
    <objectId>CAM:1</objectId>
    <ts>2012-12-27T15:19:16+04:00</ts>
  </event>
</events>
```

#### JSON:

```
[ {
  "id" : "{E56B09A0-1A50-E211-840E-005056C00008}",
  "description" : "Record is off",
  "ts" : "2012-12-27T15:43:27.000+04:00",
  "objectId" : "CAM:1"
}, {
  "id" : "{4482F63F-1A50-E211-840E-005056C00008}",
  "description" : "Record is off",
```

```

"ts" : "2012-12-27T15:40:50.000+04:00",
"objectId" : "CAM:1"
}, {
"ts" : "2012-12-27T15:19:16.000+04:00",
"objectId" : "CAM:1"
} ]

```

### 4.3 Maps

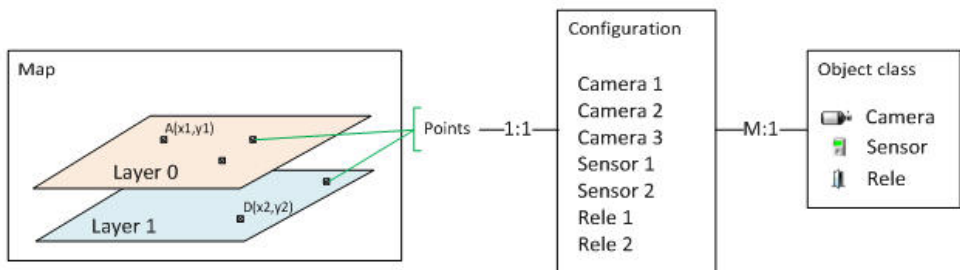

Several maps can be created on the server. Each map can consists of one or more layers. There are points on each layer. Each point corresponds to one of the objects in configuration.

Configuration – objects in Intellect. Each object represents the object of specific class. Each object has one state and the list of actions to be performed.

The object class describes its icons, possible states and possible actions with the object in each state.

#### 4.3.1 Getting the list of maps

There can be 0 or more maps

[http://example.com:\[port\]/web2/secure/kartas/](http://example.com:[port]/web2/secure/kartas/)

**Sample of response:**

```

<kartas>
  <karta>
    <id>plan</id>
    <name>This is plan of a building</name>
  </karta>
  <karta>
    <id>site</id>
    <name>This is site around the building</name>
  </karta>
</kartas>

```

#### 4.3.2 Information on one map

[http://example.com:\[port\]/web2/secure/kartas/plan/](http://example.com:[port]/web2/secure/kartas/plan/)

where plan is the Map ID;

base is the Layer ID.

**Sample of response:**

```
<karta>
  <id>plan</id>
  <name>This is plan of a building</name>
</karta>
```

### 4.3.3 The list of layers for specific map

plan – map id

There can be 1 or more layers

[http://example.com:\[port\]/web2/secure/kartas/\*\*plan\*\*/layers/](http://example.com:[port]/web2/secure/kartas/<b>plan</b>/layers/)

**Sample of response:**

```
<layers>
  <layer>
    <height>1000</height>
    <id>base</id>
    <mapId>plan</mapId>
    <name>Base layer for plan</name>
    <width>1000</width>
    <zoomDef>1.0</zoomDef>
    <zoomMax>4.0</zoomMax>
    <zoomMin>0.25</zoomMin>
    <zoomStep>0.25</zoomStep>
  </layer>
</layers>
```

**Parameters:**

Height – height of layer's image in pixels;

Width – width of layer's image in pixels;

zoomMin – minimal zoom;

zoomMax – maximal zoom;

zoomStep – zoom step when zooming in or zooming out;

zoomDef – zoom by default.

**Sample.** If image width is 100 pixels, then width for 0.25 zoom is  $100 \cdot 0.25 = 25$  pixels.

### 4.3.4 Information on a specific layer

Information on parameters is given in [The list of layers for specific map](#) section.

[http://example.com:\[port\]/web2/secure/kartas/\*\*plan\*\*/layers/\*\*base\*\*/](http://example.com:[port]/web2/secure/kartas/<b>plan</b>/layers/<b>base</b>/)

where plan is the Map ID;

base is the Layer ID.

**Sample of response:**

```
<layer>
  <height>1000</height>
  <id>base</id>
  <mapId>plan</mapId>
  <name>Base layer for plan</name>
  <width>1000</width>
  <zoomDef>1.0</zoomDef>
  <zoomMax>4.0</zoomMax>
  <zoomMin>0.25</zoomMin>
  <zoomStep>0.25</zoomStep>
</layer>
```

### 4.3.5 Layer background

http://[IP Address]:[port]/web2/secure/kartas/1/layers/2/image.[png|jpg]

where:

- **[IP Address]:[port]** are server IP address and port.
- **1** – map id.
- **2** – layer id.
- **[png|jpg]** – image format (select one of them).

Image in specified format comes in response.

**Note.**

404 error comes to **JPG, Jpg, JPEG, PNG** query.

### 4.3.6 The list of point on the layer

http://example.com:[port]/web2/secure/kartas/**plan**/layers/**base**/points/

where plan is the Map ID;

base is the Layer ID.

id in the sample is the same as id of object in configuration. Id is not necessarily equal to CAM:1. Id is to be considered as a line.

The coordinate plane is attached to the layer as follows:



I.e. x and y cannot be negative, but can be fractional.

**Sample of response:**

```
<points>
  <point>
    <id>CAM:1</id>
    <layerId>base</layerId>
    <mapId>plan</mapId>
    <x>100.0</x>
    <y>100.0</y>
  </point>
  <point>
    <id>CAM:2</id>
    <layerId>base</layerId>
    <mapId>plan</mapId>
    <x>200.0</x>
    <y>200.0</y>
  </point>
  <point>
    <id>GRAY:1</id>
    <layerId>base</layerId>
    <mapId>plan</mapId>
    <x>300.0</x>
    <y>300.0</y>
  </point>
  <point>
    <id>GRAY:2</id>
    <layerId>base</layerId>
    <mapId>plan</mapId>
    <x>400.0</x>
    <y>400.0</y>
  </point>
</points>
```

```

</point>
<point>
  <id>GRELE:1</id>
  <layerId>base</layerId>
  <mapId>plan</mapId>
  <x>500.0</x>
  <y>500.0</y>
</point>
<point>
  <id>GRELE:2</id>
  <layerId>base</layerId>
  <mapId>plan</mapId>
  <x>600.0</x>
  <y>600.0</y>
</point>
</points>

```

### 4.3.7 Information on a specific point on the layer

[http://example.com:\[port\]/web2/secure/kartas/plan/layers/base/points/CAM:2](http://example.com:[port]/web2/secure/kartas/plan/layers/base/points/CAM:2) – request for information on a point corresponding to the camera with id 2.

where plan is the Map ID;

base is the Layer ID.

#### Sample of response:

```

<point>
  <id>CAM:2</id>
  <layerId>base</layerId>
  <mapId>plan</mapId>
  <x>200.0</x>
  <y>200.0</y>
</point>

```

## 4.4 Object classes

### 4.4.1 The list of object classes on the server

[http://example.com:\[port\]/web2/secure/objectClasses](http://example.com:[port]/web2/secure/objectClasses)

#### Sample of response:

```

<objectClasses>
  <objectClass>
    <id>GRELE</id>
  </objectClass>

```

```

<objectClass>
  <id>USERS</id>
</objectClass>
<objectClass>
  <id>CAM</id>
</objectClass>
<objectClass>
  <id>RIGHTS</id>
</objectClass>
<objectClass>
  <id>GRAY</id>
</objectClass>
</objectClasses>

```

#### 4.4.2 Specific object class

[http://example.com:\[port\]/web2/secure/objectClasses/GRELE/](http://example.com:[port]/web2/secure/objectClasses/GRELE/)

**Sample of response:**

```

<objectClass>
  <id>GRELE</id>
</objectClass>

```

#### 4.4.3 The list of states for a specific object class

[http://example.com:\[port\]/web2/secure/objectClasses/GRELE/states/](http://example.com:[port]/web2/secure/objectClasses/GRELE/states/) - get the list of states for the **Relay** object class.

**Sample of response:**

```

<states>
  <state>
    <id>off</id>
  </state>
  <state>
    <id>on</id>
  </state>
  <state>
    <id>disabled</id>
  </state>
</states>

```

#### 4.4.4 Information on a specific state

[http://example.com:\[port\]/web2/secure/objectClasses/\[ObjectClass\]/states/\[State\]/](http://example.com:[port]/web2/secure/objectClasses/[ObjectClass]/states/[State]/)

Sample:

http://example.com:[port]/web2/secure/objectClasses/**GRELE**/states/**off**/ - getting information on the OFF state for the **Relay** object class.

**Sample of response:**

```
<state>
  <id>off</id>
</state>
```

#### 4.4.5 Getting the icon for a specific state

http://example.com:[port]/web2/secure/objectClasses/**[ObjectClass]**/states/**[State]**/image.png

**Sample:**

http://example.com:[port]/web2/secure/objectClasses/**GRELE**/states/**off**/image.png - getting the icon for the OFF state for the **Relay** object class.

The image in png format comes in response:



#### 4.4.6 The list of events for a specific object class

GET

http://example.com:[port]/web2/secure/objectClasses/**GRELE**/events/ - getting the list of events for the **Relay** object class.

**Sample of response:**

**XML**

```
<events>
  <event>
    <id>23</id>
    <sid>grele.disable</sid>
    <description>Disable rele</description>
  </event>
  <event>
    <id>24</id>
    <sid>grele.enable</sid>
    <description>Enable rele</description>
  </event>
<baseObject>
  <CAM>
    <id>CAM:1</id>
    <name>Camera 1</name>
    <state>
      <id>disconnected</id>
    </state>
  </CAM>
```

```

<GRELE>
  <id>GRELE:2</id>
  <name>Relay[GRELE] 2</name>
  <state>
    <id>off</id>
  </state>
</GRELE>
<GRELE>
  <id>GRELE:1</id>
  <name>Relay 1</name>
  <state>
    <id>disabled</id>
  </state>
</GRELE>
<GRAY>
  <id>GRAY:2</id>
  <name>Ray 2</name>
  <state>
    <id>alarmed</id>
  </state>
</GRAY>
</baseObjects>

```

## 4.5 Objects

### 4.5.1 Getting list of objects

[http://example.com:\[port\]/web2/secure/configuration/?pageItems=3&page=2](http://example.com:[port]/web2/secure/configuration/?pageItems=3&page=2) – returns the list of the following objects with states:

- cameras added to the Web-server with IDs of linked microphones, dynamics, PTZ devices, presets (see also [Selecting and configuring cameras for the Web-server module](#)).
- cameras added to maps selected for Web Server 2.0 are returned – see [Selecting maps](#).
- sensors;
- relays;
- macros;
- RTSP servers with ports used, cameras added.

#### Parameters:

**page** – optional parameter. Sets the number of a page displayed as a result. By default: 1.

**pageItems** – optional parameter. Sets the number of objects displayed on the page. By default: 1000.

#### Important!

If there are many objects in the system (>1000) they are to be displayed by pages.

Processing of all objects is performed page by page until an empty array is received.

**Request example:**

http://127.0.0.1:8085/web2/secure/configuration

**Response example:**

**XML**

```
<baseObjects>
  <STREAMING_SERVER>
    <extId>1</extId>
    <id>STREAMING_SERVER:1</id>
    <name>RTSP Server 1</name>
    <state>
      <id>normal</id>
      <type>NORMAL</type>
    </state>
    <type>STREAMING_SERVER</type>
    <cams>1;</cams>
    <port>554</port>
  </STREAMING_SERVER>
  <MACRO>
    <extId>001</extId>
    <id>MACRO:001</id>
    <name>001 Lightning ON 01</name>
    <state>
      <id>normal</id>
      <type>NORMAL</type>
    </state>
    <type>MACRO</type>
  </MACRO>
  <CAM>
    <extId>1</extId>
    <id>CAM:1</id>
    <name>Camera 1</name>
    <regionId/>
    <state>
      <fullState>ARMED|DETACHED</fullState>
      <id>disconnected</id>
      <type>ALARM</type>
    </state>
    <type>CAM</type>
    <additionalInfo/>
    <micId/>
    <presets/>
    <speakerId/>
    <telemetryId>1.1</telemetryId>
  </CAM>
</baseObjects>
```

**JSON**

```
[ {
  "type": "CAM",
  "id": "CAM:2",
  "extId": "2",
  "name": "Camera 2",
  "regionId": "2.1",
```

```

"state": {
  "id": "alarmed",
  "type": "ALARM"
},
"presets": [ ]
}, {
  "type": "CAM",
  "id": "CAM:1",
  "extId": "1",
  "name": "Camera 1",
  "state": {
    "id": "armed",
    "type": "NORMAL"
  },
  "presets": [ ]
}, {
  "type": "GRAY",
  "id": "GRAY:1",
  "extId": "1",
  "name": "Sensor 1",
  "state": {
    "id": "disconnected",
    "type": "ALARM"
  }
}, {
  "type": "GRELE",
  "id": "GRELE:2",
  "extId": "2",
  "name": "Relay 2",
  "state": {
    "id": "disabled",
    "type": "NORMAL"
  }
}, {
  "type": "GRELE",
  "id": "GRELE:1",
  "extId": "1",
  "name": "Relay 1",
  "regionId": "2.1",
  "state": {
    "id": "disabled",
    "type": "NORMAL"
  }
}, {
  "type": "GRAY",
  "id": "GRAY:2",
  "extId": "2",
  "name": "Sensor 2",
  "state": {
    "id": "disconnected",
    "type": "ALARM"
  }
} ]

```

## 4.5.2 Information on a specific object

[http://example.com:\[port\]/web2/secure/configuration/GRAY:2/](http://example.com:[port]/web2/secure/configuration/GRAY:2/) - getting information on the **Sensor** object with id 2.

### Sample of response:

```
<GRAY>
  <id>GRAY:2</id>
  <name>Ray 2</name>
  <state>
    <id>alarmed</id>
  </state>
</GRAY>
```

## 4.5.3 State of a specific object

[http://example.com:\[port\]/web2/secure/configuration/GRAY:2/state/](http://example.com:[port]/web2/secure/configuration/GRAY:2/state/) - getting a state for the **Sensor** object with id 2.

### Sample of response:

```
<state>
<fullState>ON,ARMED</fullState>
<id>armed</id>
<type>NORMAL</type>
</state>
```

The <fullState> contains a full object state as stored in the database, the <type> and <id> tags are object state in terms of HTTP API. Possible values of fullState parameter for a sensor are as follows:

Sensor state	fullState in web request	dbo.state
Armed + Closed	ON,ARMED	ON ARMED
Armed + Closed+ Alarm	ON,ALARMED	ON ALARMED
Armed + Closed+ Alarm confirmed	ON,CONFIRMED	ON CONFIRMED
Armed + Closed+ Connection lost	ON,DETACHED_DISARM	ON DETACHED_DISARM
Disarmed + Closed	ON,DISARMED	ON DISARMED
Disarmed + Closed+ Alarm	ON,ALARMED	ON ALARMED
Disarmed + Closed+ Alarm confirmed	ON,CONFIRMED	ON CONFIRMED
Disarmed + Closed+ Connection lost	ON,DETACHED_DISARM	ON DETACHED_DISARM
Armed + Opened	ARMED,OFF	ARMED OFF
Armed + Opened+ Alarm	OFF,ALARMED	OFF ALARMED
Armed + Opened+ Alarm confirmed	OFF,CONFIRMED	OFF CONFIRMED
Armed + Opened+ Connection lost	DETACHED_DISARM,OFF	DETACHED_DISARM OFF
Disarmed + Opened	DISARMED,OFF	DISARMED OFF
Disarmed + Opened+ Alarm	OFF,ALARMED	OFF ALARMED
Disarmed + Opened+ Alarm confirmed	OFF,CONFIRMED	OFF CONFIRMED

Sensor state	fullState in web request	dbo.state
Disarmed + Opened+ Connection lost	DETACHED_DISARM,OFF	DETACHED_DISARM OFF

#### 4.5.4 The list of available actions with the object in a specific state

The list of actions is requested not by the object class, but is taken in the context of a specific object as various user rights are possible for the objects of the same class.

Information on how to use this list is given in [Sending commands to server](#) section.

`http://example.com:[port]/web2/secure/configuration/GRAY:2/state/actions/` - getting the list of available actions for the **Sensor** object with id 2.

##### Sample of response:

```
<actions>
  <action>
    <description>Disarm ray</description>
    <id>ray.disarm</id>
  </action>
  <action>
    <description>Confirm alarm</description>
    <id>ray.confirm</id>
  </action>
</actions>
```

If the object state considers no actions, then xml is:

```
<actions/>
```

#### 4.6 Product version

`http://example.com:[port]/web2/product/version`

Such URL can be used to identify server

If the response is text/plain line like

Intellect 4.8.4

It means that the server supports the protocol described in this document. The line can change depending on the product version. This helps to distinguish 2 web servers with similar functionality but different protocols in different products.

#### 4.7 Sending commands to server

PUT

`http://example.com:[port]/web2/secure/configuration/GRAY:2/state/actions/DISARM/execute` - sample of how to send the disarm **Sensor** with id 2 command to the sever.

##### Important!

The command name (in this example – DISARM) is to be in upper case.

## 4.8 Macros

### In the section:

- [Getting the list of macros](#)
- [Getting parameters of macros](#)
- [Macros execution on server request](#)

Macros - predefined sequence of responses to certain events. Macros are created on the server and have IDs and names. They are similar to actions with objects, but are not attached to the object.

### 4.8.1 Getting the list of macros

GET

`http://example.com:[port]/web2/secure/actions/`

#### Sample of response:

```
<actions>
  <action>
    <description>Start recording by all cameras</description>
    <id>macro2</id>
  </action>
  <action>
    <description>Disarm all zones</description>
    <id>1</id>
  </action>
</actions>
```

### 4.8.2 Getting parameters of macros

Object has no extra parameters. The list of macros is sufficient.

GET

`http://example.com:[port]/web2/secure/actions/macro2/` - getting parameters of macro with macro2 id.

#### Sample of response:

```
<action>
  <description>Start recording by all cameras</description>
  <id>macro2</id>
</action>
```

### 4.8.3 Macros execution on server request

PUT

`http://example.com:[port]/web2/secure/actions/macro2/execute` - request to execute macro with id macro2 on the server.

## 4.9 Video

### 4.9.1 Configuration request

GET

`http://example.com:[port]/web2/secure/video/config.properties?version=4.7.8.0&login=XXX&password=YYY`

**Parameters:**

- version – mandatory field. Client version (if protocol is changed). Now the **4.7.8.0** value is to be sent.
- login – optional field.
- password - optional field. It is in use if access is protected with the password.

**Features of using**

At the start it is not clear if the login and password are in use. To make it clear, send the following query:

GET

`http://www.examplehost.com/web2/secure/video/config.properties?version=4.7.8.0`

The server sends back the config.properties text file:

`password.enabled=true`

`login.enabled=true`

`password.invalid=true#`

 **Note.**

# symbol means the ending of configuration file.

When you get this file, it becomes clear that the password has been set and it is not correct. It is not correct because the login and password fields were blank.

Request the login and password and send configuration query to the server once again:

GET

`http://www.examplehost.com/web2/secure/video/config.properties?version=4.7.8.0&login=XXX&password=YYY`

If the password is correct or access is allowed without the password, then the server sends the following configuration:

`password.enabled=true`

`login.enabled=true`

`password.invalid=false`

`cam.0.id=2`

`cam.0.name=Face`

`cam.0.rights=11`

`cam.1.id=3`

`cam.1.name=Camera 3`

`cam.1.rights=11`

`cam.2.id=5`

`cam.2.name=Camera 5`

`cam.2.rights=11`

`cam.2.telemetry_id=1.1`

`cam.count=3#`

password.invalid=false means the specified password is not correct.

**Note.**

If access is allowed without the password, then password.enabled=false and configuration will be received on the first try.

cam.count=3 - total of cameras in the configuration (id starts at 0).

Get the data for each of 3 cameras in configuration.

cam.N.id - camera id.

cam.N.name - camera name.

cam.N.rights - rights.

cam.N.telemetry\_id - telemetry id (there can be no value if there is no telemetry - then hide telemetry control elements).

cam.N.rights - rights (they are checked on the server; available on the client in order not to show the user odd options). The parameter is represented by flags. If the flag is set, then the interface element is to be shown; if not - hidden.

```
static final int RIGHT_VIEW = 0x1; // live video is available(always 1)
static final int RIGHT_CONTROL = 0x2; // control (telemetry, arming and disarming)
static final int RIGHT_CONFIG = 0x4; // reserved
static final int RIGHT_HISTORY = 0x8; // access to archive
```

## 4.9.2 Video query

http://example.com:[port]/web2/secure/video/action.do?

version=4.7.8.0&sessionId=FC126734&cam.id=5&login=XXX&password=YYY - request for video from a camera with ID 5.

cam.id - camera ID.

sessionId - any value.

If version 4.10.0.0 is specified in request, then the *stream obtained* is in *MJPEG* format without XML inserts - it can be displayed on a web page using the IMG tag in Chrome and FireFox browsers. This feature is implemented for both live and archive video.

**Note.**

Not more than 6 video streams can be received simultaneously.

Request sample:

http://10.0.36.158:8085/web2/secure/video/action.do?version=4.10.0.0&sessionId=1234567890&video\_in=CAM:1&imageWidth=200&fps=1&login=1&password=1

Here is an example of using request results on the web page:

```
<html>
<head/>
<body>
  
</body>
</html>
```

## 4.9.3 Format of main stream

Stream of following view will be received in reply

```

HTTP/1.0 200 OK
Connection: close
Server: ITV-Intellect-Webserver/4.9.0.0
Cache-Control: no-store,no-cache,must-revalidate,max-age=0
Pragma: no-cache
Date: Mon, 13 Jan 2013 10:44:27 GMT
Content-Type: multipart/mixed;boundary=videoframe
--videoframe
Content-Type: text/xml
Content-Length: 138

<video_in>
  <sessionid>FC126734</sessionid>
  <video_in>CAM:5</video_in>
  <newstate>started</newstate>
  <errcode>100</errcode>
</video_in>
--videoframe
Content-Type: image/jpeg
Content-Length: 23978
X-Width: 320
X-Height: 240
X-Time: 2013-03-15T10:51:44.314+04:00
X-Timestamp: 0.000
<jpeg image>
--videoframe
Content-Type: image/jpeg
Content-Length: 23651
X-Width: 320
X-Height: 240
X-Time: 2013-03-15T10:51:44.314+04:00
X-Timestamp: 0.152
<jpeg image>

```

**Where:**

- X-Width - image width.
- X-Height- image height.
- X-Time - absolute time of frame forming.
- X-Timestamp - relative frame time in seconds (relatively stream head).

In case of stream end due to the fault of server, the end packet can be received:

```
--videoframe
Content-Type: text/xml
Content-Length: 106
<video_in>
  <sessionid>FC126734</sessionid>
  <video_in>CAM:5</video_in>
  <newstate>closed</newstate>
  <errcode>103</errcode>
</video_in>
```

- sessionid - session ID (the same as at start).
- video\_in - camera ID.
- errcode - error code:
  - 100 – error absence.
  - 101 – too many connected users.
  - 102 – invalid password (theoretically, it's possible to change password at any moment).
  - 103 – unavailable video.
  - 104 – old client version. Update version.

### 4.9.3.1 Managing records

#### Start recording

GET

http://example.com:[port]/web2/secure/video/action.do?  
version=4.7.8.0&sessionid=29101F1&cam.id=1&target=CAM&targetid=1&command=REC&login=XXX&password=YYY

#### Stop recording

GET

http://example.com:[port]/web2/secure/video/action.do?  
version=4.7.8.0&sessionid=29101F1&cam.id=5&target=CAM&targetid=1&command=REC\_STOP&login=XXX&password=YYY

Here targetid==cam.id

### 4.9.3.2 Arming and disarming the camera

#### Arming

GET

http://example.com:[port]/web2/secure/video/action.do?  
version=4.7.8.0&sessionid=29101F1&cam.id=1&target=CAM&targetid=1&command=ARM&login=XXX&password=YYY

#### Disarming

GET

http://example.com:[port]/web2/secure/video/action.do?  
version=4.7.8.0&sessionid=29101F1&cam.id=5&target=CAM&targetid=1&command=DISARM&login=XXX&password=YYY

targetid==cam.id

## 4.9.4 Thumbnails request

### 4.9.4.1 Method 1

http://example.com:[port]/web2/secure/video/image.jpg?cam.id=1&version=4.7.8.0

**Parameters:**

cam.id – required. Camera ID.

width – optional. Value can be in [64, 1600] range. Server automatically rounds width to larger value divisible by 4.

height – optional. Value can be in [30, 1200] range.

version – optional. client version (for protocol exchange). It's required to send "4.7.8.0" value now.

login – optional. Login;

password – optional. If password access is set.

Size of returned image is taken from video stream if width and height parameters are not set.

**Returned value:**

jpeg image of approximately requested size.

In case of error the http error code is returned:

404 – camera disabled or not in use (disabled);

403 – invalid password;

426 – old client version;

429 – too many requests;

444 – camera signal is lost or camera disabled (coaxial conductor disconnected from card);

503 – archive error.

**Example:**

Get image from camera 5, width is approximately 85 pixels:

`http://localhost:8079/web2/secure/video/image.jpg?cam.id=5&width=85&version=4.7.8.0&login=username&password=secret`

Jpg image of width 88 pixels or error code and zero length body (i.e. only headings) will be received in reply).

#### 4.9.4.2 Method 2

`http://example.com:[port]/web2/secure/video/action.do?version=4.9.0.0&command=frame.video&video_in=CAM:1&imageWidth=400&imageHeight=200`

cam.id – camera ID.

sessionId – any value.

imageWidth – requested frame width.

imageHeight – requested frame height.

**Example:**

Receive a frame from Camera 1 with a height of 400 pixels.

`http://192.168.0.79:8085/web2/secure/video/action.do?version=4.9.0.0&command=frame.video&video_in=CAM:1&imageWidth=400`

#### 4.9.5 Authorization by token

Add 2 parameters to the request in order to get pre-authorized and signed links to video streams (both live and archive video):

- **enable\_token\_auth** - enable authorization by token =**1**.
- **valid\_token\_hours** - signature validation time (in hours). The maximum value is a week. The default value is 12 hours.

Login and password are to be specified in order to receive token.

Sample:

`http://127.0.0.1:8085/web2/secure/video/action.do?version=4.10.0.0&sessionId=FC126734&video_in=CAM:1&enable_token_auth=1&valid_token_hours=1&login=1&password=1`

Response:

```
{
"path" : "action.do?hmac=GAqUa429sjY2E9jCTpuYeaMqReW3Y7HI"
}
```

To get the video by this token, use a request like this:

```
http://example.com:[port]/action.do?hmac=GAqUa429sjY2E9jCTpuYeaMqReW3Y7HI
```

This link becomes disabled after the specified period of time. The [port] is the port number specified for HTTP Server connection on the **Web server** object settings panel (see [Setting the parameters of connecting Clients to the Web-server](#)).

## 4.10 PTZ control

GET

```
http://example.com:[port]/web2/secure/video/action.do?
version=4.7.8.0&sessionId=29101F1&cam.id=5&target=PTZ&targetid=1.1&command=RIGHT&login=XXX&password=YYY&speed=2
```

### Parameters:

**command** – required parameter. It takes the following values:

- RIGHT
- UP
- LEFT
- DOWN
- ZOOM\_IN
- ZOOM\_OUT
- GO\_PRESET – go to the specified preset.
- POINTMOVE – zooming of selected point on the image (x,y).
- AREAZOOM – zooming of selected area on the image (x,y,w,h).

**speed** – required parameter. Command-processing speed (from 0 to 10). It is recommended to use low values due to delays while controlling by network

**cam.id** – required parameter. Camera ID.

**target** – required parameter. Always is equal to PTZ.

**targetid** – required parameter. Id of PTZ connected with camera (is sent in the SETUP configuration).

**preset** – number of preset. Required parameter only for the command=GO\_PRESET. Otherwise its value is ignored.

**x** – x coordinate relatively the image size. It takes values from 0.0 to 1.0. Required parameter only for the command=POINTMOVE or command=AREAZOOM. Otherwise its value is ignored.

**y** – y coordinate relatively the image size. It takes values from 0.0 to 1.0. Required parameter only for the command=POINTMOVE or command=AREAZOOM. Otherwise its value is ignored.

**w** – width of zooming area relatively the image size. It takes values from 0.0 to 1.0. Required parameter only for the command=AREAZOOM. Otherwise its value is ignored.

**h** – height of zooming area relatively the image size. It takes values from 0.0 to 1.0. Required parameter only for the command=AREAZOOM. Otherwise its value is ignored.

## 4.11 Using the archive

### In the section:

- [Getting list of records - "arc.intervals"](#)
- [Getting one frame from archive - "arc.frame"](#)
  - [1st way](#)
  - [2nd way](#)
- [Getting video from archive - "arc.play"](#)
- [Getting list of records \(the second way\)](#)

Video archive stream is sent on the same format as live video.

### 4.11.1 Getting list of records - "arc.intervals"

GET

```
http://example.com:[port]/web2/secure/video/action.do?version=4.9.0.0&sessionId=29101F1&video_in=CAM:5&command=arc.intervals&time_from=2013-03-20T00:00:00.000+04:00&time_to=2013-03-22T23:59:59.999+04:00&max_count=100&split_threshold=10399&login=XXX&password=YYY
```

Required parameters:

command=arc.intervals – command to receive list of records

video\_in – camera ID.

time\_from – start of interested time range.

Optional parameters:

time\_to – start and end of interested time range.

max\_count – maximal number of records in reply

split\_threshold – time for combining several intervals (in seconds). Intervals, distance between which will be less than specified value, will be combined in one.

format – if absent, the response is in XML; if set to json, the response is JSON.

Example **XML** response:

```
<?xml version="1.0" encoding="UTF-8"?>
<records count="1" complete="YES" sort="INCREASE">
  <record>
    <from>2011-09-01T00:00:00-05:00</from>
    <to>2011-09-01T00:00:35-05:00</to>
  </record>
  <record>
    <from>2011-09-01T00:00:35-05:00</from>
    <to>2011-09-01T00:01:10-05:00</to>
  </record>
</records>
```

Example **JSON** response:

```
{ 'count' : 1,
  'complete' : 'YES',
  'sort' : 'INCREASE',
  'cam' : '1',
  'records' : [ {
    'from' : '2019-01-22T12:41:10.144+03:00',
    'to' : '2019-01-23T08:28:47.346+03:00'
  } ]
}
```

## 4.11.2 Getting one frame from archive - "arc.frame"

### 4.11.2.1 1st way

GET

[http://example.com:\[port\]/web2/secure/video/action.do?version=4.9.0.0&sessionId=29101F1&video\\_in=CAM:5&command=arc.frame&time=2013-03-22T13:04:52.312+04:00&range=0.1&login=XXX&password=YYY](http://example.com:[port]/web2/secure/video/action.do?version=4.9.0.0&sessionId=29101F1&video_in=CAM:5&command=arc.frame&time=2013-03-22T13:04:52.312+04:00&range=0.1&login=XXX&password=YYY)

Required parameters:

command=arc.frame - command for one frame;

video\_in - camera ID;

time - interested time.

Optional parameters:

range - time in seconds to specify search range of the nearest frame relatively the time parameter (the nearest frame all over archive is searched if this parameter is not specified);

imageWidth - width in pixels (is counted automatically with saving proportions if it isn't specified or equal 0);

imageHeight - height in pixels (is counted automatically with saving proportions if it isn't specified or equal 0);

fps - maximal frame frequency per second (if it isn't specified or equal 0, frame frequency won't be limited if).

In return http-headings and the nearest frame from the [time - range, time + range] range in the jpeg format will be received. The reply body will be empty if there is no frame in the range.

#### 4.11.2.2 2nd way

Get the nearest frame to the "time" from "video\_in":

[http://example.com:\[port\]/action.do?version=4.9.0.0&video\\_in=CAM:1&command=arc.frame&time=2018-08-12T22:29:06Z](http://example.com:[port]/action.do?version=4.9.0.0&video_in=CAM:1&command=arc.frame&time=2018-08-12T22:29:06Z)

Example response:

Request Details		permalink	raw	Headers	
POST	<a href="http://webhook.site/4589bc86-e597-41d3-aab8-a93b09e977a8">http://webhook.site/4589bc86-e597-41d3-aab8-a93b09e977a8</a>			connection	close
Host	159.69.14.138 <a href="#">whois</a>			x-forwarded-for	159.69.14.138
Date	2019-06-14 12:44:40			user-agent	Apache-HttpClient/4.1.4 (Java/1.8.0_201)
ID	1d1d0274-ddb1-409b-bb75-dc950a12265d			host	webhook.site
				content-type	application/json; charset=UTF-8
				content-length	369
Query strings				Form values	
(empty)				(empty)	
<pre>SubscriptionEvent(   action=ALARM_EVENT,   uniqueUUID={59321A11-A28E-E911-9D70-1C1B0DE94CFB},   time=Fri Jun 14 15:43:54 MSK 2019,   params=Params(     additionalDataString=     [{"name":"incident","value":"264400"}, {"name":"picture","value":"http://172.17.11.11:8095/action.do?version=4.9.0.0&amp;video_in=CAM:8&amp;command=arc.frame&amp;time=2019-06-14T15:43:54Z"}]   ),   cameraCode=8 )</pre>					

#### 4.11.3 Getting video from archive - "arc.play"

GET

[http://example.com:\[port\]/web2/secure/video/action.do?version=4.9.0.0&sessionId=29101F1&video\\_in=CAM:5&command=arc.play&time\\_from=2013-03-22T13:04:52.312+04:00&time\\_to=2013-03-22T13:16:31.873+04:00&login=XXX&password=YYY](http://example.com:[port]/web2/secure/video/action.do?version=4.9.0.0&sessionId=29101F1&video_in=CAM:5&command=arc.play&time_from=2013-03-22T13:04:52.312+04:00&time_to=2013-03-22T13:16:31.873+04:00&login=XXX&password=YYY)

Required parameters:

command=arc.play - command to get video from archive;

video\_in - camera ID;

time\_from - start time of archive playing back.

Optional parameters:

time\_to - completion time of archive playing back (if parameter is not specified, all archive will play back);

imageWidth - width in pixels (is counted automatically with saving proportions if it isn't specified or equal 0);

imageHeight - height in pixels (is counted automatically with saving proportions if it isn't specified or equal 0);

maximal frame frequency per second (if it isn't specified or equal 0, frame frequency won't be limited if).

End packet with newstate=closed and errcode=100 will be received when stream completion.

#### 4.11.4 Getting list of records (the second way)

GET

[http://example.com:\[port\]/web2/secure/archive/CAM:2/\[2011-12-30|2011-12\]?\[splitThreshold=50\]&\[days=1\]](http://example.com:[port]/web2/secure/archive/CAM:2/[2011-12-30|2011-12]?[splitThreshold=50]&[days=1])

splitThreshold - if difference between end of previous record and start of next record less than specified value (in milliseconds), than records will be combined in one. Specify splitThreshold=0. [default: 50] not to combine records.

days - number of days from the current, for which archive is required. [default: 1]

All time is interpreted as local time for server.

Get records for 18 November 2013 and combine all records, interval between which less than 2000 milliseconds:

[http://example.com:\[port\]/web2/secure/archive/CAM:1/2013-10-18/?splitTreshold=2000](http://example.com:[port]/web2/secure/archive/CAM:1/2013-10-18/?splitTreshold=2000)

Get records for 10 days from 18 November 2013:

[http://example.com:\[port\]/web2/secure/archive/CAM:1/2013-10-18/?days=10](http://example.com:[port]/web2/secure/archive/CAM:1/2013-10-18/?days=10)

#### XML:

```
<?xml version="1.0" encoding="UTF-16"?>
<days>
  <day>
    <id>2013-11-10T00:00:00-02:00</id>
    <records>
      <from>2013-11-10T18:44:01.579-02:00</from>
      <to>2013-11-10T18:44:09.717-02:00</to>
    </records>
  </day>
  <day>
    <id>2013-11-18T00:00:00-02:00</id>
    <records>
      <from>2013-11-18T18:38:30.252-02:00</from>
      <to>2013-11-18T18:38:56.942-02:00</to>
    </records>
    <records>
      <from>2013-11-18T18:39:08.321-02:00</from>
      <to>2013-11-18T18:39:10.080-02:00</to>
    </records>
  </day>
</days>
```

#### JSON:

```
[ {
  "id" :
  "2013-11-10T00:00:00.000-02:00",
  "records" : [ {
    "from" :
    "2013-11-10T18:44:01.579-02:00",
    "to" :
    "2013-11-10T18:44:09.717-02:00"
  } ]
}, {
  "id" : "2013-11-18T00:00:00.000-02:00",
  "records" : [ {
    "from" :
    "2013-11-18T18:38:30.252-02:00",
    "to" :
    "2013-11-18T18:38:56.942-02:00"
  }, {
    "from" :
    "2013-11-18T18:39:08.321-02:00",
    "to" :
    "2013-11-18T18:39:10.080-02:00"
  } ]
} ]
```

Getting records for a month (shows days of September at which there are records):

[http://example.com:\[port\]/web2/secure/archive/CAM:2/2011-12/](http://example.com:[port]/web2/secure/archive/CAM:2/2011-12/)

**XML:**

```
<?xml version="1.0" encoding="UTF-8"?>
<days>
  <day>
    <id>2011-09-02T00:00:00-05:00</id>
  </day>
  <day>
    <id>2011-09-03T00:00:00-05:00</id>
  </day>
  <day>
    <id>2011-09-05T00:00:00-05:00</id>
  </day>
</days>
```

**JSON:**

```
[ {
  "id" :
  "2011-09-01T00:00:00-0500",
  "records" : [ ]
}, {
  "id" :
  "2011-09-03T00:00:00-0500",
  "records" : [ ]
}, {
  "id" :
  "2011-09-01T00:00:00-0500",
  "records" : [ ]
} ]
```

If there are no records, the following will be received

**XML:**

<days/>

**JSON:**

[]

## 4.12 Notification

**In the section:**

- [Subscribing](#)
- [Subscription cancellation](#)
- [APN message format](#)

APNS(iOS), C2DN (Android), etc. notification systems are in use.

deviceid – device token (APNs), registration id (C2DN), etc.;

username – login. The field can be blank.

### 4.12.1 Subscribing

When the app connects to service, the APNS messages subscription is performed. So when the app is closed, device will receive events notifications.

POST

http://example.com:[port]/web2/secure/subscription/

Reply with “201 Created” code means that subscribing is performed successfully.

Code 400 means that specified parameters are invalid (deviceid is not to be empty, it's length should be from 5 to 150 symbols and contain only digits and letter of English alphabet).

The POST body should contain information about created subscribing. Only JSON format is received. It's required to specify the Content-Type title properly.

**Sample of response:**

## JSON

### Content-Type : application/json

```
{
  "username" : "johndoe",
  "deviceid" : "somedeviceid"
}
```

## 4.12.2 Subscription cancellation

Subscription is cancelled in the following cases:

- The user subscribed to events from other device;
- Device token or registration id is changed;
- Another user subscribed to events from this device;
- Subscription is cancelled manually.

### DELETE

http://example.com:[port]/web2/secure/subscription/[deviceId]

Reply with “204 No Content” code means that subscribing is performed successfully.

## 4.12.3 APN message format

```
{
  "aps" : {
    "alert" : "Motion Detected",
    "badge" : 2 //ordinal number of the message. Numbers are given one after another after the latest subscribing.
  },
  "e" : {
    "srv" : "XXX", //server id. Unique in one iOS device
    "stt" : 88, //state id(see The list of states for a specific object class)
    "obj" : "6", //object id
    "ts" : "2010-08-02T23:30:00Z" //time of sending the event
  }
}
```

## 4.13 Sound

### 4.13.1 Getting live sound

#### GET

http://example.com:[port]/web2/secure/video/action.do?

version=4.9.0.0&sessionId=FC126734&command=audio.play&audio\_in=MIC:5&format=L16&login=XXX&password=YYY

sessionId – session ID (is not in use yet).

audio\_in – audio stream ID.

format – format of audio data (only L16 yet).

Audio packets of the following view will be received:

```

HTTP/1.0 200 OK
Connection: close
Server: ITV-Intellect-Webserver/4.9.0.0
Cache-Control: no-store,no-cache,must-revalidate,max-age=0
Pragma: no-cache
Date: Mon, 13 Jan 2013 10:44:27 GMT
Content-Type: multipart/mixed;boundary=audioframe

```

```

--audioframe
Content-Type: text/xml
Content-Length: 138

```

```

<audio_in>
  <sessionid>FC126734</sessionid>
  <audio_in>MIC:5</audio_in>
  <newstate>started</newstate>
  <errcode>100</errcode>
</audio_in>

```

```

--audioframe
Content-Type: audio/L16;rate=8000;channels=1
Content-Length: 1024
X-Time: 2013-03-22T13:16:31.371+04:00

```

```

<audio packet PCM16>
--audioframe
Content-Type: audio/L16;rate=8000;channels=1
Content-Length: 1278
X-Time: 2013-03-22T13:16:31.873+04:00

```

```
<audio packet PCM16>
```

To stop stream without connection break send the following command in the same connection

```

GET
http://example.com:[port]/web2/secure/video/action.do?
version=4.9.0.0&sessionid=29101F1&command=audio.stop&audio_in=MIC:5&login=XXX&password=YYY

```

The end xml packet will be received::

```

--audioframe
Content-Type: text/xml
Content-Length: 106
<audio_in>
  <sessionid>FC126734</sessionid>
  <audio_in>MIC:5</audio_in>

```

```
<newstate>closed</newstate>
<errcode>100</errcode>
</audio_in>
```

### 4.13.2 Playing sound from archive

GET

```
http://example.com:[port]/web2/secure/video/action.do?
version=4.9.0.0&sessionId=29101F1&command=arc.play&audio_in=MIC:
5&format=L16&time_from=2013-03-22T13:16:31.873+04:00&time_to=2013-03-22T13:04:52.312+04:00&login=XXX&password=YYY
```

audio\_in – audio stream ID;

format – requested format (only L16 yet);

time\_from - start time of archive playing back;

time\_to - end time of archive playing back.

The stream will be received in the same view as in case of live sound.

The end xml packet will be received when data completion (as when getting live sound – see [Getting live sound](#)).

### 4.13.3 Sending live sound

Sending of sound is performed by serial communication of packets using commands:

POST

```
http://example.com:[port]/web2/secure/video/action.do?
version=4.9.0.0&sessionId=FC126734&command=audio.receive&audio_out=SPEAKER:3&login=XXX&password=YYY
```

Content-type: audio/L16;rate=8000;channels=1

Connection: keep-alive

Then audio packet transmission will perform.

Format of sound – only L16.

rate – any rational value.

channels – from 1 to 6.

## 4.14 Commands used for ECHD integration

ECHD means ‘Unified data center’ state information system.

The description of http requests that are used for integration of *Intellect* with ECHD is given in this section. For requests operation they are to be enabled at the stage of system configuration – see [Enabling the processing of ECHD requests and selecting rtsp server](#).

Requests are sent to **Web Server** and are performed only for cameras under which the **ECHD channel** object is created.

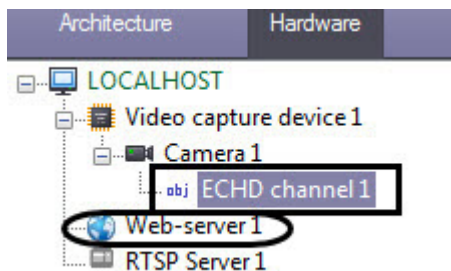

### 4.14.1 Archive downloading

GET

```
http://example.com:[port]//downloadarchivefile?cameraid=1&fromdatetime=2014-10-01T00:00:00&todatetime=2014-10-01T01:20:05
```

**Example:**

```
GET http://192.168.15.182:80/downloadarchivefile?cameraid=1&fromdatetime=2014-10-01T00:00:00&todatetime=2014-10-01T01:20:05
```

Response

```
HTTP/1.1 200 OK
```

```
Content-Type: application/octet-stream
```

Also, as a result of the command, a file with the .es extension will be received (for example, Camera [4] (2019-08-13T11\_00\_00 - 2019-08-13T12\_10\_00).es). Convert this file using the ffmpeg utility to play it. This utility is available for download on the official website <https://ffmpeg.org/>

Example command to convert H.264-coded file:

```
ffmpeg -i "C:\path to the .264 file\Camera[5].es" -c:v copy -bsf:v h264_mp4toannexb -c:a copy -f avi output.avi
```

Example command to convert H.265-coded file:

```
ffmpeg -i "C:\path to the .265 file\Camera[5].es" -c:v copy -bsf:v hevc_mp4toannexb -c:a copy -f avi output.avi
```

The .avi file (output.avi) is created after this command execution.

### 4.14.2 Archive export

**In the section:**

- [Creating archive export request](#)
- [Getting export status](#)
- [Deleting archive](#)

By default, the archive is exported in mp4 format. Change the format using the ExportContainerFormat registry key (see [Registry keys reference guide](#)). The export of the archive in H.264 or MPEG4 formats is supported.

#### 4.14.2.1 Creating archive export request

Example:

```
POST http://192.168.15.182:80/createarchivetask
```

```
Content Type: application/json
```

Content:

```
{
  "CameraId": "1",
  "From": "2016-06-27T15:10:00.00Z",
  "To": "2016-06-27T15:20:00.00Z"
}
```

Response:

```
{
  "CameraId" : "1",
  "From" : "2016-06-27T15:10:00.00Z",
  "To" : "2016-06-27T15:20:00.00Z",
  "ArchiveTaskId" : "084b56a5-bd49-4327-82db-9bc911f7ff96",
  "ErrorMessage" : null,
  "State" : "Created"
}
```

The folder with the corresponding name (084b56a5-bd49-4327-82db-9bc911f7ff96) and mp4 file inside it is created in the export folder (by default C:\Users\User\Documents\Intellect\export).

#### 4.14.2.2 Getting export status

Example:

GET <http://192.168.15.182:80/getarchivetaskstatus?archivetaskid=104b38d4-07d7-4d2f-84da-49b3e255d2bf>

Response:

```
{
  "Percents" : 100,
  "Url" : "http://192.168.15.182:80/download?file=104b38d4-07d7-4d2f-84da-49b3e255d2bf",
  "CameraId" : "1",
  "From" : "2016-06-27T15:10:00.000+03:00",
  "To" : "2016-06-27T15:11:00.000+03:00",
  "ArchiveTaskId" : "104b38d4-07d7-4d2f-84da-49b3e255d2bf",
  "ErrorMessage" : "null",
  "State" : "ReadyForDownload"
}
```

The required mp4 file can be downloaded using the link in the URL bar.

#### 4.14.2.3 Deleting archive

Example:

DELETE <http://192.168.15.182:80/removearchive?archivetaskid=084b56a5-bd49-4327-82db-9bc911f7ff96>

Response:

```
{
  "ArchiveTaskId" : "084b56a5-bd49-4327-82db-9bc911f7ff96",
  "ErrorMessage" : null,
  "Success" : true
}
```

The corresponding folder with mp4 file will be deleted from the export folder.

### 4.14.3 List of cameras and their parameters

#### In the section:

- [GetCameras](#)
- [GetDeviceInfo](#)

#### 4.14.3.1 GetCameras

GET

`http://example.com:[port]/getcameras`

Returns the list of IDs of cameras registered on the video encoder/video server. Additionally, it can contain information on the status of the video surveillance device.

Example:

GET `http://192.168.15.182:80/getcameras`

Response:

```
{
"cameras": [
{
"id": 1,
"channel": 1,
"status": "working"
},
{
"id": 2,
"channel": 2,
"status": "signallost"
}
]
}
```

#### 4.14.3.2 GetDeviceInfo

GET `http://example.com:[port]/getdeviceinfo`

Returns information about the device (firmware version, manufacturer, model and serial number).

#### Note.

Any prefix can be added to the firmware version value returned by the `AdditionalVersionString` registry key – see [Registry keys reference guide](#).

Example:

GET `http://192.168.15.182:80/getdeviceinfo`

Response

```
{
"firmware version": "1.2.3 Rev B.",
"vendor": "Vendor Title Ltd"
"model": "Device Model",
"serial_number": "12345ABCDEF",
"ptz-status": "not supported"
}
```

#### 4.14.4 Ranges of available archive recordings

GET

http://example.com:[port]/getarchiveranges?cameraid=1

Returns time periods over which archive recordings from the specified video surveillance device are available.

**Note.**

By default fragments are merged if the interval between them is less than 5 seconds. This time period can be changed using the SplitArchiveIntervals registry key (see [Registry keys reference guide](#)).

**Example:**

GET http://192.168.15.182:80/getarchiveranges?cameraid=1

Response:

```
{
"cameraid": 1,
"ranges": [
{
"from": 1412121600, //unixtime
"to": 1412172000
},
{
"from": 1412186400,
"to": 1412188200
}]
}
```

## 4.14.5 Video surveillance device features management

### In the section:

- [Discrete motion](#)
- [Relative motion](#)
- [Setting position of video surveillance device](#)
- [Getting position of video surveillance device](#)
- [Focusing](#)
- [Iris control](#)
- [Night mode](#)
- [Backlight](#)
- [BW mode](#)

### ⚠ Important!

Disable the **Use device settings** checkbox in order to change the manage parameters by the below commands – see [The Settings panel of the Video Capture Device object](#).

A camera must support the same commands for features management as the given ECHD commands (both when connected via ONVIF and via the corresponding driver).

### 4.14.5.1 Discrete motion

`https://example.com:[port]/?cameraID={1}& ip={2}& login={3}&pass={4}& action={5}&x={6}&y={7}&z={8}&modelName={9}`

Atomic shift of video surveillance device in the specified direction.

*cameraID* - ID of video surveillance device.

*ip* - IP address of video surveillance device.

*login* - account of video surveillance device.

*pass* - access password to video surveillance device.

*action* - command name [*degreesmove*].

*x* - PAN rotation [-180 ..0.. 180].

*y* - TILt rotation [-180 ..0.. 180].

*z* - zoom in/out [0.. 100].

*modelName* – model of video surveillance device.

### 4.14.5.2 Relative motion

`https://example.com:[port]/?cameraID={1}&ip={2}&login={3}&pass={4}&action={5}&x={6}&y={7}&z={8}&modelName={9}`

Rotation of video surveillance device compared with current position. Viewing area of video surveillance device is divided by a grid where central point's coordinates are (x:0, y:0), top left (x:-7, y:7), bottom right (x:7, y:-7). Video surveillance device must be rotated in a way that object appears in the center of the grid.

'Optical' error caused by the distance to the visible object is allowed.

Error caused by sphere-to-plane projection must be compensated.

*cameraID* - ID of video surveillance device.

*ip* - IP address of video surveillance device.

*login* - account of video surveillance device.

*pass* - access password to video surveillance device.

*action* - command name (*degreesmove2*). When connected via ONVIF, the camera must support Point&Click and the ReplacePointAndClick registry key must be set to 1 (see [Registry keys reference guide](#)) in order to execute this command.

*x* - PAN rotation [-7..0..7].

*y* - tilt rotation [-7..0..7].

*Z* - deprecated parameter. The value is ignored; may be excluded from the request.

*modelName* - model of video surveillance device.

#### 4.14.5.3 Setting position of video surveillance device

`https://example.com:[port]/?cameraID={1}&ip={2}&login={3}&pass={4}&action={5}&x={6}&y={7}&z={8}&modelName={9}`

Setting position of video surveillance device in degrees compared with '0' position.

*cameraID* - ID of video surveillance device.

*ip* - IP address of video surveillance device.

*login* - account of video surveillance device.

*pass* - access password to video surveillance device.

*action* - command name (*setposition*).

*x* - PAN setting [-180 ..0.. 180].

*y* - TILt setting [-180 ..0..180].

*Z* - zoom value [0.. 100].

*modelName* - model of video surveillance device.

#### 4.14.5.4 Getting position of video surveillance device

`https://example.com:[port]/?cameraID={1}&ip={2}&login={3}&pass={4}&action={5}&modelName={6}`

Getting position of video surveillance device in pAN and TILt in degrees as well as current zoom values.

**Response** in JSON format:

```
{"y":56, "x":105, "z":0}
```

*cameraID* - ID of video surveillance device.

*ip* - IP address of video surveillance device.

*login* - account of video surveillance device.

*pass* - access password to video surveillance device.

*action* - command name (*getposition*).

*modelNate* - model of video surveillance device.

#### 4.14.5.5 Focusing

`https://example.com:[port]/?cameraID={1}&ip={2}&login={3}&pass={4}&action={5}&x={6}&y={7}&z={8}&modelName={9}`

Video surveillance device's focus control command where z parameter controls over focus:

1: Focus in

-1 : Focus out

0: Auto

*cameraID* - ID of video surveillance device.

*ip* - IP address of video surveillance device.

*login* - account of video surveillance device.

*pass* - access password to video surveillance device.

*action* - command name (*focus*).

*x* - not in use [0].

*y* - not in use [0].

*z* - focus control [-1..0..1].

*modelName* - model of video surveillance device.

#### 4.14.5.6 Iris control

[https://example.com:\[port\]/?cameraID={1}&ip={2}&login={3}&pass={4}&action={5}&x={6}&y={7}&z={8}&modelName={9}](https://example.com:[port]/?cameraID={1}&ip={2}&login={3}&pass={4}&action={5}&x={6}&y={7}&z={8}&modelName={9})

Video surveillance device's iris control command where z parameter controls over iris:

1: Open iris

-1: Close iris

0: Auto

*cameraID* - ID of video surveillance device.

*ip* - IP address of video surveillance device.

*login* - account of video surveillance device.

*pass* - access password to video surveillance device.

*action* - command name (*iris*).

*x* - not in use [0].

*y* - not in use [0].

*z* - iris control [-1..0..1].

*modelName* - model of video surveillance device.

#### 4.14.5.7 Night mode

[https://example.com:\[port\]/?cameraID={1}&ip={2}&login={3}&pass={4}&action={5}&x={6}&y={7}&z={8}&modelName={9}](https://example.com:[port]/?cameraID={1}&ip={2}&login={3}&pass={4}&action={5}&x={6}&y={7}&z={8}&modelName={9})

The following operation modes of video surveillance device are available:

1: Day mode

-1 : Night mode

*cameraID* - ID of video surveillance device.

*ip* - IP address of video surveillance device.

*login* - account of video surveillance device.

*pass* - access password to video surveillance device.

*action* - command name (*switch\_day\_night*).

*x* - not in use [0].

*y* - not in use [0].

*z* - mode control [-1..0..1].

*modelName* - model of video surveillance device.

#### 4.14.5.8 Backlight

`https://example.com:[port]/?cameraID={1}&ip={2}&login={3}&pass={4}&action={5}&x={6}&y={7}&z={8}&modelName={9}`

The following backlight operation modes are available:

1: Enable

-1: Disable

*cameraID* - ID of video surveillance device.

*ip* - IP address of video surveillance device.

*login* - account of video surveillance device.

*pass* - access password to video surveillance device.

*action* - command name (*backlight*).

*x* - not in use [0].

*y* - not in use [0].

*z* - mode control[-1..0..1].

*modelName* - model of video surveillance device.

#### 4.14.5.9 BW mode

`https://example.com:[port]/?cameraID={1}&ip={2}&login={3}&pass={4}&action={5}&x={6}&y={7}&z={8}&modelName={9}`

The following operation modes of video surveillance device are available:

1: Enable

-1: Disable

*cameraID* - ID of video surveillance device.

*ip* - IP address of video surveillance device.

*login* - account of video surveillance device.

*pass* - access password to video surveillance device.

*action* - command name (*switch\_color*).

*x* - not in use [0].

*y* - not in use [0].

*z* - mode control[-1..0..1].

*modelName* - model of video surveillance device.

### 4.14.6 Working with video streams

#### In the section:

- [GetLiveUrl\(CameraId\)](#)
- [GetArcliveURL\(CameraId, FromDatetime, toDatetime\)](#)

#### 4.14.6.1 GetLiveUrl(CameraId)

GET

`http://example.com:[port]/getliveurl?cameraid=1`

Returns rtsp URL of “live” video stream for the specified camera.

Example:

GET `http://192.168.15.182:80/getliveurl?cameraid=1`

Response

```
{
"rtspurl": "rtsp://device-address/somelivemediastream0"
}
```

#### 4.14.6.2 GetArcliveURL(CameraId, FromDatetime, toDatetime)

GET

`http://example.com:[port]/getarchiveurl?cameraid=1&fromdatetime=2014-10-01T00:00:00&todatetime=2014-10-01t01:20:05`

Returns rtsp URL of archive video stream received from video encoder for the specified camera starting from FromDateTime (and, optionally, ending at endDatetime).

**Example:**

GEt `http://192.168.15.182:80/getarchiveurl?cameraid=1&fromdatetime=2014-10-01T00:00:00&todatetime=2014-10-01t01:20:05`

Response

```
{
"rtspurl": "rtsp://deviceaddress/somearchivemediastream?somedatetimetoken"
}
```

### 4.15 Sending reactions or events to Intellect with HTTP API

#### 4.15.1 Sending HTTP API commands using curl tool

To test HTTP API one can send HTTP API commands using curl tool. This tool is available at <https://curl.haxx.se/>.

To use the tool start the Windows command line and go to <curl installation directory>\curl-7.46.0-win64\bin folder.

Find the example of the command to create the archive export task below (see [Archive export](#)):

```
curl -H "Content-Type: application/json" -X POST -d "{ \"CameraId\": \"1\", \"From\": \"2017-12-26T10:58:00.00Z\", \"To\": \"2017-12-26T11:00:00.00Z\" }" http://127.0.0.1:80/createarchivetask
```

Response example:

```
{ "CameraId": "1", "From": "2017-12-26T10:58:00.00Z", "To": "2017-12-26T11:00:00.00Z", "ArchiveTaskId": "084b56a5-bd49-4327-82db-9bc911f7ff96", "ErrorMessage": null, "State": "Created" }
```

#### 4.15.2 Sending reactions and events to Intellect using HTTP request. Request for archive frame

*Intellect* gets commands and events to a port set in the RestPort registry key:

```
http://[Intellect Server IP]:10112/intellect_core/React?command="[Intellect format command]"
```

```
http://[ Intellect Server IP]:10112/intellect_core/Event?command="[ Intellect format
```

```
command]"
http://[ Intellect Server IP]:10112/video/GetImage/CamNo/UTC_Time
```

#### Important!

The RestPort key is set to 0 by default, so the function of sending reactions and events to Intellect using HTTP request is disabled. To enable it, set the RestPort key value, for example, RestPort=10112. See details in [Registry keys reference guide](#).

#### Examples:

Add captions to video from camera 2 via HTTP request:

```
http://localhost:10112/intellect_core/React?command="CAM|2|ADD_SUBTITLES|command<Some text\n!>"
```

Generate alarm on camera 2 via HTTP request:

```
http://localhost:10112/intellect_core/Event?command="CAM|2|MD_START"
```

Run Macro 1 via HTTP request:

```
http://localhost:10112/intellect_core/React?command="MACRO|1|RUN"
```

When getting such commands, standard events and reactions will be generated in *Intellect* – they can be used in scripts and macros (see [Creating and using macros](#) section of [Administrator's Guide](#) as well as [Programming Guide \(JScript\)](#)).

Request archive frame (screenshot) from camera 1 on date 07.11.2018 and time 13:20:56.212

```
http://localhost:40000/video/GetImage/1/20181107T132056.212
```

The response is a jpeg image or HTTP ERROR 404

### 4.15.3 Sending reactions to Intellect via HttpListener

In order to send reactions to the Intellect software via HttpListener, create **Video Capture Device** object under the **Computer** object on the **Hardware** tab of the **System Settings** dialog box, then select **HttpListener** as its **Type** and set connection port in the **Port** field. Also, create no more than 4 **Sensor** objects under this **Video Capture Device** object.

HttpListeners only allows sending reactions to close/open a normally opened/closed Sensor. In 2 seconds after the command execution, the sensor goes back to its normal state. Macros or scripts can be configured in *Intellect* to handle sensor triggering.

The command for HttpListener:

```
POST http://IP-address:port/device/di/0
```

with the body of {"state": "closed"} or {"state": "opened"}

where

- **port** is the HttpListener's port.
- 0/1/2/3 – Sensor ID.
- **state** – **opened** or **closed**.

Example:

```
http://127.0.0.1:8080/device/di/0
{"state": "closed"}
```

## 4.16 Configuring the Technoserv integration

Create and configure the following objects and files in order to configure the Technoserv integration:

1. **Web-server** – see [Configuring the videosever to connect Clients via the Web-server module](#).
2. **Web-server 2.0** – see [Configuring the server for the clients connection via the Web-server 2.0 module](#).
3. At least one **User** object added to **User permissions**. The Technoserv connection with *Intellect* will be established under this user's credentials. See [Rights administration](#).
4. Enable filter for camera and detection tool events on the **Web-server 2.0** object settings panel – see [Configuring the Events filter for the Web-server 2.0 module](#).
5. Add all cameras to get events from to the Web-server configuration – see [Selecting and configuring cameras for the Web-server module](#).
6. Fill in the ApiBgConfig.xml configuration file, then put it to "<Intellect installation path>\Modules\Jetty\". See [Filling in the ApiBgConfig.xml configuration file](#).

See also [Examples of commands to work with the Technoserv integration](#).

#### 4.16.1 Filling in the ApiBgConfig.xml configuration file

The ApiBgConfig.xml file is used to configure the login and password for connecting the Technoserv system to *Intellect*, as well as for associating *Intellect* events with the Technoserv event codes (see the table below).

The file has the following format:

```
<ApiBgEventsConfiguration>
  <PingTimeout>120000</PingTimeout>
  <MainHost>127.0.0.1</MainHost>
  <Login></Login>
  <Password></Password>
  <ApiBgEventMatch>
    <ProductObjectName>CAM</ProductObjectName>
    <ProductEventName>DETACHED</ProductEventName>
    <ApiBgEventCode>not_available</ApiBgEventCode>
  </ApiBgEventMatch>
  <ApiBgEventMatch>
    <ProductObjectName>CAM</ProductObjectName>
    <ProductEventName>ATTACH</ProductEventName>
    <ApiBgEventCode>available</ApiBgEventCode>
    <Picture>1</Picture>
  </ApiBgEventMatch>
  <ApiBgEventMatch>
    <ProductObjectName>CAM</ProductObjectName>
    <ProductEventName>ALARM</ProductEventName>
    <ApiBgEventCode>264400</ApiBgEventCode>
    <Shapes>1</Shapes>
    <Picture>1</Picture>
  </ApiBgEventMatch>
  <ApiBgEventMatch>
    <ProductObjectName>CAM</ProductObjectName>
    <ProductEventName>REC</ProductEventName>
    <ApiBgEventCode>264409</ApiBgEventCode>
    <Shapes>1</Shapes>
    <Picture>1</Picture>
  </ApiBgEventMatch>
</ApiBgEventsConfiguration>
```

1. The time in milliseconds between sending PING events  
<PingTimeout>120000</PingTimeout>
2. The IP-address to be returned on requests of Technoserv.  
<MainHost>192.168.0.171</MainHost>
3. Username and password to connect to the Technoserv server and send events (if any)  
<Login></Login> <Password></Password>
4. Correspondence of the *Intellect* event to the event code:  
<ApiBgEventMatch>
  - <ProductObjectName>CAM\_VMDA\_DETECTOR</ProductObjectName>
  - <ProductEventName>ALARM</ProductEventName>
  - <ApiBgEventCode>264400</ApiBgEventCode>
  - <ProductObjectIds>
    - <id>2</id>
    - <id>1</id>
  - </ProductObjectIds>
  - <ParamMatch>
    - <ProductEventParamName>num</ProductEventParamName>
    - <ApiBgEventParamCode>NUMBER\_OF\_DETECTED\_PEOPLE</ApiBgEventParamCode>
  - </ParamMatch>
  - <Shapes>1</Shapes>
  - <Picture>1</Picture>

- a. ProductObjectName, ProductEventName – Intellect object and event, for example, CAM|MD\_START.
- b. ProductObjectIds – Intellect object id, if you need to specify specific detectors. May be absent, then events will be transmitted to all detectors.
- c. ApiBgEventCode – event code, see below.
- d. Shapes – whether to transfer the Shapes field.
- e. Picture – whether to send a link to the freeze frame.
- f. ParamMatch – correspondence of the Intellect event parameter name to the event parameter. May be absent.

## Event codes:

Code	Event name
1799	Crowd Detection (detect crowds, including in unauthorized places)
264393	Abandoned object detection
264383	People counter
264385	Estimated people traffic density in significant city sites
264388	Detection of moving against crowd flow
264387	Person stopped in the controlled area (with the preset stop time)
264386	Sharp acceleration of human movement
264389	Chaotic human movement (idleness)
264391	Indexing events in traffic conditions (traffic jams)
264392	Indexing of events in traffic conditions (massive accumulation of vehicles)
264390	Indexing events in traffic conditions (traffic density)
264394	Detection of crossing the forbidden zone (by human or vehicle)
264395	Disappeared object detection
264396	Responding to the passage of people in a given direction (entrance)
264397	Responding to the passage of people in a given direction (exit)
264399	Responding to the passage of people in a given direction (corridor etc.)
264398	Responding to the passage of people in a given direction (crosswalk)
264400	Appearance of a person or car in the observation zone (streets, squares, intersections, parks)
1795	Focus loss detection
1797	Dirty camera lens

Code	Event name
264403	Background change
264402	Camera shift
1796	Blind/cover detection
264401	Bare flame
287069	Target detected
siren	Siren or car alarm detected
shout	Human cry detected
klaxon	The sound of the car horn detected
voice	Human speech detected
brake	The sound of a vehicle brake detected
shockwave	A shock wave detected
shock	A bang/shot/blast detected
PING	It is used for a regular event periodicity sent to control the communication channel between the IS and the "Safe City" software and hardware complex. Value is filled as cameraCode=-1.
not_available	The camera is unavailable (there is no video stream or no connection with the camera, etc.)
available	The camera is available

## 4.16.2 Examples of commands to work with the Technoserv integration

Use the following command to work with the Technoserv integration:

`http://<IP address>:<Port>/web2/secure/api/bg[/request]`

The 127.0.0.1 IP address and default 8085 port of the Web server 2.0 are given in the examples below. This data is subject to change.

### 4.16.2.1 Getting a list of cameras

GET `http://127.0.0.1:8085/web2/secure/api/bg`

#### Note.

If in the **Additional information** field on the camera settings panel is filled in the format `coords:[longitude]:[latitude]:[angle]:[azimuth]:[radius]`, then this data will be returned in response to the request in the corresponding parameters. See also [Additional information on camera](#).

#### Example response

```

▼ 0:
  cid:           "8"
  name:          "Камепа 8"
  longitude:     "50.0825508"
  latitude:      "14.4410435"
  angle:         "56"
  azimuth:       "223"
  radius:        "23"
  webviewurl:    "http://172.17.11.11:8095/"
  streamHost:    "172.17.11.11"
  streamHttpPort: "8095"
  available:     false

```

### 4.16.2.2 Get a list of subscriptions

GET <http://127.0.0.1:8085/web2/secure/api/bg/events/subscriptions>

#### Example response:

when the list is empty:

```

data: []
status: "success"

```

when the list has subscriptions:

```

▼ data:
  ▼ 0:
    ▼ callback: "https://webhook.site/4589bc86-e597-41d3-aab8-a93b09e977a8"
    ▼ filter:
      action: "RUN"
      type: "MACRO"
      id: "8"
      id: "63eb2852-9780-4085-bf5e-f3e5be875357"
    status: "success"

```

### 4.16.2.3 Create subscription

POST <http://127.0.0.1:8085/web2/secure/api/bg/events/subscriptions>

```

{"callback":"https://webhook.site/26d15078-c405-4918-8f03-4f2a01b7580f","filter":
{"action":"RUN","type":"MACRO"},"id":"5"}

```

#### Example response:

Request Details		Headers	
Method	POST	connection	close
URL	http://webhook.site/4589bc86-e597-41d3-aab8-a93b09e977a8	x-forwarded-for	159.69.14.138
Host	159.69.14.138 <a href="#">whois</a>	user-agent	Apache-HttpClient/4.1.4 (Java/1.8.0_201)
Date	2019-06-14 12:33:14	host	webhook.site
ID	7b6f6e05-0dbd-49d1-b1ff-4f2a734e7421	content-type	application/json; charset=UTF-8
		content-length	369
		Form values	(empty)
Query strings	(empty)		
<pre>SubscriptionEvent(   action=ALARM_EVENT,   uniqueUUID={4C9E2133-9F8E-E911-9D70-1C1B0DE94CF8},   time=Fri Jun 14 15:23:28 MSK 2019,   params=Params(     additionalDataString=     [{"name":"incident","value":"264400"}, {"name":"picture","value":"http://172.17.11.11:8095/action.do?version=4.9.0.0&amp;video_in=CAM:8&amp;command=arc.frame&amp;time=2019-06-14T15:23:28Z"}]   ),   cameraCode=8 )</pre>			

### 4.16.2.4 Delete subscription

DELETE http://127.0.0.1:8085/web2/secure/api/bg/events/subscriptions/071e0159-5b2c-4bab-8ed7-42397f1b99b8

### 4.16.2.5 Delete all subscriptions

DELETE http://127.0.0.1:8085/web2/secure/api/bg/events/subscriptions/all

## 5 Intellect HTTP-Server

### 5.1 General information on HTTP-Server

*HTTP-Server* allows you to transfer the events from *Intellect* to the third-party systems, i.e. to notify the clients about the events. The *HTTP-Server* module operation requires the web browser to support the Server-sent events (SSE) technology.

#### **Note**

Internet Explorer browser does not support the SSE technology.

The *HTTP-Server* module is configured on the settings panel of the corresponding object — see [Configuring the HTTP-Server object](#).

The requests sent from a web browser are used to work with the *HTTP-Server* module - see [HTTP-Server requests](#).

### 5.2 Configuring the HTTP-Server object

The **HTTP-Server** object is configured as follows:

1. Create the **HTTP-Server** object on the basis of the **Computer** object on the **Hardware** tab of the **System Settings** dialog box (1). The settings panel of the created object will be displayed on the right side of this window.

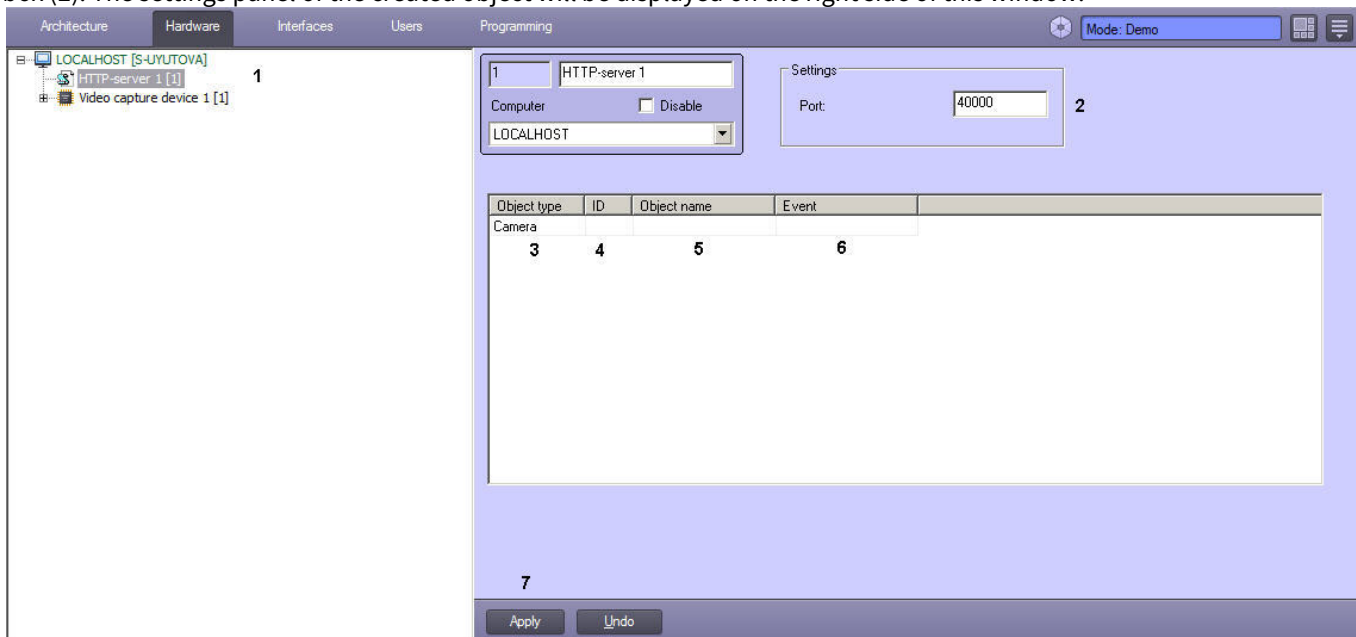

2. In the **Port** field, specify the port number in the system where the client should send the *HTTP-Server* requests (2).
3. Configure the filter for the events which information should be sent by the *HTTP-Server*. If no events are added to the filter, then the *HTTP-Server* will return only the core events (the CORE object) for the client requests. The additional events are selected as follows:
  - a. From the **Object type** drop-down list, select the required *Intellect* object type (3).
  - b. From the **ID** drop-down list, select the identifier of the object of the selected type (4). If no ID is selected, then the *HTTP-Server* will send the events for all objects of the selected type.
  - c. After selecting the type and object identifier, the **Object name** field will be automatically filled with the name of the corresponding object (5).
  - d. From the **Event** drop-down list, select the type of event which should be sent via the *HTTP-Server* (6). If no event is selected, the *HTTP-Server* will send all events of the selected object (or all objects of the selected type).
  - e. Repeat steps a-d for all required objects and events.
4. Click **Apply** (7).

Configuring the **HTTP-Server** object is complete.

## 5.3 HTTP-Server requests

The requests described below are used when working with the *HTTP-Server* module.

### The last event ID request

`http://<IP-адрес>:<Порт>/core/GetLastID`

Request example

`http://localhost:40000/core/GetLastID`

Response example

```
{"lastId": "b686658c-764c-e911-8f42-001a7dda710e"}
```

### The event request based on filter

The filter is configured on the settings panel of the HTTP-Server object — see [Configuring the HTTP-Server object](#).

`http://<IP-адрес>:<Порт>/core/EventsTest`

Request example

`http://localhost:40000/core/EventsTest`

Response example

```
{"module": "video.run", "protocol_id": "2dc6dfcb-5351-e911-8832-534e57000000", "slave_id": "S-UYUTOVA", "src_action": "MD_STOP", "src_objid": "2", "src_objtype": "CAM", "time": "2019-03-28T12:20:03.977"}
```

## 6 Intellect software Integration Guide. Postscript

More detailed information on the Intellect software package is presented in the documents titled:

1. [Administrator's Guide](#);
2. [Operator's Guide](#);
3. [Installing and configuring security system components guide](#);
4. [Programming Guide \(JScript\)](#).

If while operating the given software product you have faced difficulties and problems, you are welcome to contact us. However before addressing us, we kindly ask you to answer the following questions:

1. What is the problem?
2. When did the problem occur and what had happened before it occurred?
3. Which conditions gave rise to the problem?

Remember, that the more detailed and precise information you give us, the faster our experts will resolve your problem.

We are striving to improve the quality of our products, and hence welcome any proposals and suggestions how to improve our software and documentation.

Please forward your suggestions to the following e-mail addresses: [documentation@axxonsoft.com](mailto:documentation@axxonsoft.com)

## 7 APPENDIX 1. DDI file structure

The table below contains a description of the fields of the table from the **Names** tab (the **<Objects>** section):

Field	Description
Name (<ObjectName>)	Object ID
Visible name (<VisibleName>)	Visible name
Group name (<GroupName >)	The name of a group of objects. Used for grouping objects in Intellect's settings tree

The table below contains a description of the fields of the table from the **Events** tab (the **<Events>** section):

Field	Description
Name (<EventName>)	Event ID
Description (<EventDescription>)	Event description recorded in the event log
Event handling (<EventType>)	Used to set the background color in the event log normal – no background color; alarm – red window; information – blue window
Sound support (<IsSoundEnabled>)	A sound file is played when a message arrives.
Do not send over network (<IsNetworkDisabled>)	Messages will not be sent over the network
Do not log (<IsProtocolDisabled>)	Events will not be recorded in the event log
Windows log (<IsWindowsLogEnabled>)	Record messages in the Windows log. <i>Note: Recording in the Windows log is impossible for an event, if the event is not logged</i>

The table below contains a description of the fields of the table from the **Reacts** tab (the **<Reacts>** section):

Field	Description
Name (<ReactName>)	Reaction name
Description (<ReactDescription>)	The reaction description shown in the context menu after a right-click on the object icon on the <i>Map</i>
Flags (<IsReactArm>)	Reaction scope flags: perform actions for a single object or for a group of objects from the same section

The table below contains a description of the fields of the table from the **Icons** tab (the **<Icons>** section):

Field	Description
Filename (<FileName>)	A BMP file name (the part that serves as an image ID). An image ID allows you to use multiple BMP files to show objects of the same type on the <i>Map</i> . (see Section Using the ddi.exe Tool to Work with DDI files)
Name (<IconName>)	A description of the BMP file of an object

The table below contains a description of the fields of the table from the **States** tab (the **<States>** section):

Field	Description
Name (<StateName>)	State name
Image (<ImgName>)	BMP file name (the part that serves as a state ID). (see Section Using the ddi.exe Tool to Work with DDI files). Note: The <i>Map</i> may show objects using lines (that is, without using BMP files). In this case, when an object changes its state, the line color changes. For a state, the color (RGB) is set as follows: <b>&lt;State&gt;\$R:G:B</b>
Description (<StateDescription>)	State description
Flashing (<IsStateFlashing>)	Display on the <i>Map</i> : normal – the icon does not flash , alarm – the icon flashes

The table below contains a description of the fields of the table from the **Transition Rules** tab (the **<Rules>** section):

Field	Description
Event (<EventName>)	The event that triggers the transition
Transition From (<FromStateName>)	The start state (that is, the state that we transition from)
Transition To (<ToStateName>)	The end state (that is, the state that we transition to)

## 8 APPENDIX 2. NissObjectDLLExt and CoreInterface class declarations

**On the page:**

- [CoreInterface](#)
- [NissObjectDLLExt](#)

## 8.1 CoreInterface

```

class CoreInterface
{
public:

    virtual BOOL DoReact      (React&) = 0;

    virtual BOOL NotifyEvent(Event&) = 0;

    virtual void SetupACDevice(LPCTSTR objtype, LPCTSTR objid, LPCTSTR
objtype_reader) = 0;

    virtual   BOOL   IsObjectExist(LPCTSTR objtype, LPCTSTR id) = 0;
    virtual   BOOL   IsObjectDisabled(LPCTSTR objtype, LPCTSTR id) = 0;
    virtual   Msg    FindPersonInfoByCard(LPCTSTR facility_code, LPCTSTR card) = 0;
    virtual   Msg    FindPersonInfoByExtID(LPCTSTR external_id) = 0;
    virtual   CString GetObjectName (LPCTSTR objtype, LPCTSTR id) = 0;
    virtual   CString GetObjectState(LPCTSTR objtype, LPCTSTR id) = 0;
    virtual   void    SetObjectState(LPCTSTR objtype, LPCTSTR id, LPCTSTR state)
= 0;
    virtual   BOOL   IsObjectState(LPCTSTR objtype, LPCTSTR id, CString state) =
0;

    virtual   CString GetObjectParam      (LPCTSTR objtype, LPCTSTR id, LPCTSTR
param) = 0;
    virtual   int    GetObjectParamInt (LPCTSTR objtype, LPCTSTR id, LPCTSTR param) =
0;

    virtual   CMapStringToStringArray* GetObjectParamList(LPCTSTR objtype, LPCTSTR
id, LPCTSTR param) = 0;
    virtual   CStringArray* GetObjectParamList(LPCTSTR objtype, LPCTSTR id,
LPCTSTR param, LPCTSTR name) = 0;
    virtual   void    GetObjectParams      (LPCTSTR objtype, LPCTSTR id, Msg& msg)
= 0;
    virtual   void    SetObjectParamInt (LPCTSTR objtype, LPCTSTR id, LPCTSTR
param, int val) = 0;

```

```
= 0;

    virtual CString GetObjectIdByParam(LPCTSTR type, LPCTSTR param, LPCTSTR val)

    virtual CString GetObjectIdByName(LPCTSTR type, LPCTSTR name) = 0;

    virtual CString GetObjectParentId(LPCTSTR objtype, LPCTSTR id, LPCTSTR
parent) = 0;

    virtual int GetObjectIds(LPCTSTR objtype, CStringArray& list, LPCTSTR main_id
= NULL) = 0;

    virtual int GetObjectChildIds(LPCTSTR objtype, LPCTSTR objid, LPCTSTR
childtype, CStringArray& list) = 0;

};
```

## 8.2 NissObjectDLLExt

```

class NissObjectDLLExt
{
protected:

    CoreInterface* m_pCore;

public:

    NissObjectDLLExt(CoreInterface* core) { m_pCore = core; }

    virtual CString GetObjectType() = 0;
    virtual CString GetParentType() = 0;
    virtual int GetPos() { return -1; }
    virtual CString GetPort() { return CString(); }
    virtual CString GetProcessName() { return CString(); }
    virtual CString GetDeviceType() { return CString(); }

    virtual BOOL HasChild() { return FALSE; }
    virtual UINT HasSetupPanel() { return FALSE; }
    virtual void OnPanelInit(CWnd*) {}
    virtual void OnPanelLoad(CWnd*,Msg&) {}
    virtual void OnPanelSave(CWnd*,Msg&) {}
    virtual void OnPanelExit(CWnd*) {}
    virtual void OnPanelButtonPressed(CWnd*,UINT) {}
    virtual BOOL IsRegionObject() { return FALSE; }
    virtual BOOL IsProcessObject() { return FALSE; }
    virtual BOOL IsIncludeParentId() { return 0; }
    virtual BOOL IsWantAllEvents() { return 0; }
    virtual CString DescribeSubscribeObjectsList() { return CString(); }
    virtual CString GetIncludeIdParentType(){ return CString(); }

```

```
virtual CString DescribeParamLists(){ return CString(); }

virtual void OnCreate(Msg&) {}

virtual void OnChange(Msg&,Msg&) {}

virtual void OnDelete(Msg&) {}

virtual void OnInit(Msg&          ) {}

virtual void OnEnable(Msg&) {}

virtual void OnDisable(Msg&) {}

virtual BOOL OnEvent(Event&) { return FALSE; }

virtual BOOL OnReact(React&) { return FALSE; }

};
```