



Monitoring Administrator's Guide

Last update 01/08/2019

Table of contents

1	Introduction	5
1.1	Document purpose	5
1.2	Purpose of Monitoring	5
2	Monitoring general description.....	6
2.1	Features of Monitoring	6
2.2	Monitoring restrictions	6
3	Hardware and software requirements.....	7
3.1	Operating system requirements	7
3.2	Hardware requirements	7
4	Installing Monitoring.....	8
4.1	Installation options.....	8
4.2	Installer.....	9
4.3	Preparing for installation	9
4.4	Installation	10
4.4.1	Agent of control Installation.....	10
4.4.2	Server of control Installation.....	13
4.4.3	Additional workplace Installation.....	18
4.4.4	Central server of control installation	23
4.4.5	Additional workplace of CSC Installation.....	27
5	Configuring Agent of Control.....	33
5.1	Creating necessary Agent of Control objects	33
5.2	Configuring the logging subsystem	34
5.3	Configuring the Partition Of Control object	36
5.3.1	Configuring the Partition Of Control unique ID.....	36
5.3.2	Configuring a port for incoming UPS messages.....	36
5.3.3	Configuring communication between Agent of Control and Server of Control	37
5.3.4	Configuring captions.....	39
5.3.5	Configuring the camera list	41
5.3.6	Configuring sensors	43
5.3.7	Configuring alarm groups.....	46
5.3.8	Adding video data to alarms	50
5.4	Connecting to uninterrupted power supplies	51

5.4.1	Configuring StateUPS	51
5.4.2	Installing the software from the UPS vendor	52
5.4.3	Installing the PowerChute plus utility	58
5.4.4	Example of configuration of event distribution	61
5.5	Working with Agent of Control without Windows administration rights	63
6	Configuring Server of Control.....	64
6.1	Creating necessary Server of Control objects	64
6.2	Configuring a connection	65
6.3	Configuring the logging subsystem	66
6.3.1	Specifying storage time for event log	66
6.3.2	The Event Viewer utility	67
6.4	Configuring reaction to snapshots and videos.....	68
6.5	List of Additional workplaces	70
6.6	Sending confirmations of alarm acceptance	73
6.7	Working with Server of Control without Windows administration rights.....	74
6.8	Configuring sound notification at Server of Control.....	74
6.8.1	Configuring sound notification at Server of Control in a general way.....	74
6.8.2	Configuring sound notification at Server of Control for various alarm groups.....	75
6.9	Creating and configuring Data gateway	77
7	Configuring Central server of control	79
7.1	General principles of the Central server of control software.....	79
8	Configuring Additional workplace	80
8.1	List of Servers of Control	80
8.1.1	Interface of Additional workplace configuration tool.....	80
8.1.2	Adding Server of Control to the list.....	82
8.1.3	Selecting active Server of Control.....	86
8.2	Working with Additional workplace without Windows administration rights	86
9	Data Loader for Monitoring	87
9.1	Server of Control	87
9.2	Data Loader for Monitoring	87
9.3	Connecting to the database	88
9.4	Removing errors.....	89
9.5	Removing events from the database	89

9.6	Setting the log storage period.....	89
9.7	Configuring automated video clip loading.....	90
10	Configuration of the Monitoring interface.....	92
10.1	General information about the Monitoring interface	92
10.2	Configuring the Monitoring interface object	92
10.3	Configuration of the Search in archive object.....	95
10.4	Configuration of the Monitoring Reports object	96
11	Configuring special operation mode joint with Auto Intellect	98
11.1	Configuration at Agent of Control	98
11.2	Configuration at Server of Control.....	99
12	Appendix 1. Interfaces	101
12.1	Settings panel of the Agent of Control object	101
12.2	Settings panel of the Partition of Control object	101
12.3	Settings panel of the Server of Control object	104
12.4	Settings panel of the Monitoring interface object.....	106
12.5	Settings panel of the Monitoring reports interface object	111
12.6	Settings panel of the Search in archive interface object	114
13	Appendix 2. Sample scripts	116
13.1	Sample script for processing Server of Control command on Agent of Control	116
13.2	Sample script for setting custom filter in the Log Panel.....	116
13.3	Sample script for stopping camera recording.....	118
13.4	Sample scripts for processing alarm confirmations	119
13.5	Sample script to export filtered data from the Log Panel to .xls.....	119
13.6	Sample script to show and hide Search license plates window.....	120
14	Configuring the Monitoring fault tolerance.....	121

1 Introduction

On the page:

- [Document purpose](#)
- [Purpose of Monitoring](#)

1.1 Document purpose

This document, *Monitoring: Administrator's Guide*, is a reference aid for system administrators, configuration and installation specialists, and users with administrator rights on the *Monitoring of technical condition* software (hereinafter referred to as *Monitoring*).

This guide describes the following:

1. Purpose of *Monitoring*.
2. Hardware and software requirements for *Monitoring*.
3. Installation procedure for *Monitoring*.
4. Configuration of *Monitoring* components.

1.2 Purpose of Monitoring

Monitoring is designed to automate the activities of personnel at service companies involved in the operation of Intellect-powered video surveillance systems. The purpose of *Monitoring* is to improve the quality of operation for such video surveillance systems.

2 Monitoring general description

2.1 Features of Monitoring

Monitoring receives, records, and visualizes messages about the state of security system components, based on the following key parameters:

1. Camera operability.
2. Network functioning.
3. Operability of video subsystem software.
4. Amount of recorded video.
5. Hard disk operability.
6. Operability of fire/security and access control systems.
7. UPS signals.

In addition, the module allows monitoring the actions of monitoring operators: recording is performed of whether an alarm has been accepted, how much time passed before the alarm was accepted, and so forth. The built-in system for statistics and analysis generates reports on system operation: reports on alarms, downtime, statistics on security system operation, and more.

 **Note.**

If there is no activation key, then *Monitoring* software operates in the demo mode for 2 months from 8:00 am to 12:00 am.

2.2 Monitoring restrictions

In the *Monitoring* software package restrictions are imposed when creating systems of technical condition monitoring:

1. Maximal number of **Agent of Control** objects that can be connected to a *Server of Control* is 2000.
2. Maximal number of **Partition of Control** objects being child objects for an **Agent of Control** is 30.
3. Maximal number of cameras which a **Partition of Control** can handle is 64.

3 Hardware and software requirements

On the page:

- [Operating system requirements](#)
- [Hardware requirements](#)

3.1 Operating system requirements

Monitoring is provided as executable modules that can be run on the operation systems supported by the Intellect software (see the [Operating system requirements](#) chapter in the *Intellect* software Administrator's Guide).

The software is compatible with standard operating system settings. On Windows Vista and later, UAC must be disabled. In Windows 8, 8.1 and 10 it is necessary to configure security policies in order to entirely disable UAC (configuring security policies is described in the [Intellect software Administrator's Guide](#)).

3.2 Hardware requirements

Monitoring can run on PCs that meet the following minimum hardware requirements:

- Intel Core i5 750 CPU
- 2 GB RAM
- 200 GB HDD
- NIC
- Graphics card with overlay support

4 Installing Monitoring

4.1 Installation options

Monitoring can be installed in one of the following configurations:

Installation type	Purpose	License features	Additional components	Base Intellect installation type
<i>Agent of Control</i>	Is to be installed on the object for which receiving, recording, and visualizing messages about the state of security system components is required.	The program key, intellect.sec, should contain the Agent of Control object.	In addition to <i>Agent of Control</i> modules, the VideoSrv communication program is installed. It interacts with similar programs on the <i>Server of Control</i> .	Server
<i>Server of Control</i>	Is to be installed on the object from which the <i>Agents of Control</i> are monitored.	The program key, intellect.sec, should contain the Server of Control object.	In addition to <i>Agent of Control</i> modules the following components are installed: <ol style="list-style-type: none"> 1. VideoSrv communication module. It interacts with similar programs on the <i>Agent of Control</i>. 2. Data loader for Monitoring to record information collected by VideoSrv into the database. 	RAW
<i>Additional workplace</i>	This is the <i>Server of Control</i> version which is installed without additional components and connects to the existing database of the main <i>Server of Control</i> while interface objects are created on the local computer.	<i>Intellect</i> distributed system configuration is not required for the additional workplace operation. The Additional workplace object is to be specified in the "intellect.sec" license key that is located on <i>Server of Control</i> in order to allow using the <i>Additional workplace</i> software.	-	RAW

<i>Central Server of Control</i>	Allows to combine several <i>Servers of Control</i> into a single system.	The program key, intellect.sec, should contain the Central Server of Control object.	In addition to <i>Central Server of Control</i> modules the following components are installed: <ol style="list-style-type: none"> 1. CentralNetServer communication module. It interacts with VideoSrv modules on the <i>Server of Control</i>. 2. Data loader for <i>Central Server of Control</i> which records the information received from CentralNetServer into the database. 	RAW
<i>Additional workplace of CSC</i>	This is the <i>Central Server of Control</i> version which is installed without additional components and connects to the existing database of the main <i>Central Server of Control</i> while interface objects are created on the local computer.	<i>Intellect</i> distributed system configuration is not required for the additional workplace operation. The Additional workplace of CSC object is to be specified in the "intellect.sec" license key that is located on <i>Central Server of Control</i> in order to allow using the <i>Additional workplace</i> software.	-	RAW

4.2 Installer

The *Monitoring* installer includes the installation file setup.exe.



Documentation is included in the Help folder.

Installation language is selected according to the language settings of the base *Intellect* software. This information is stored in the Language registry key in the section HKEY_LOCAL_MACHINE\Software\Microsoft\Windows\CurrentVersion\Uninstall\Intellect\ for 32-bit OS (HKEY_LOCAL_MACHINE\Software\Wow6432Node\Microsoft\Windows\CurrentVersion\Uninstall\Intellect\ for 64-bit). If, for some reason, access to this information is not possible, the language of the current operating system locale will be used if it is available. The following languages are available: Russian and English.

4.3 Preparing for installation

Before beginning installation, copy the installation kit to a local disk and make sure that the indicated files are not marked as "read-only".

Information on compatibility of *Monitoring* and *Intellect* software versions is given on the page [General information about product releases and versions compatibility](#).

Before starting the installer, quit *Intellect*. If *Intellect* is installed as a service, stop the service.

For the *Server of control* and the *Central server of control* to operate, there must be an available database server. During installation of *Intellect*, MS SQL Server 2014 Express is installed to a "clean" (fresh) system.

The *Server of control* and the *Central server of control* are compatible with the following servers:

- MS SQL Server 2008 R2
- MS SQL Server 2012
- MS SQL Server 2014

4.4 Installation

4.4.1 Agent of control Installation

Installation of *Agent of control* software is performed in the following sequence:

1. From the installation kit, start the executable file setup.exe. The window informs of the beginning of installation. A prompt to start installation then appears. Click the **Next** button.

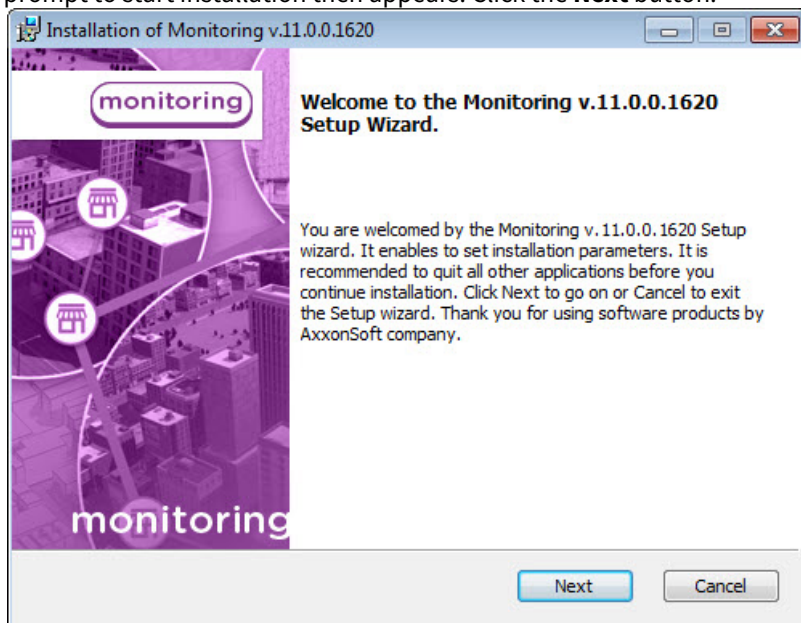

2. The **License Agreement** window presents the terms of the end user license agreement. Select **I accept the terms of the License Agreement** and click the **Next** button.

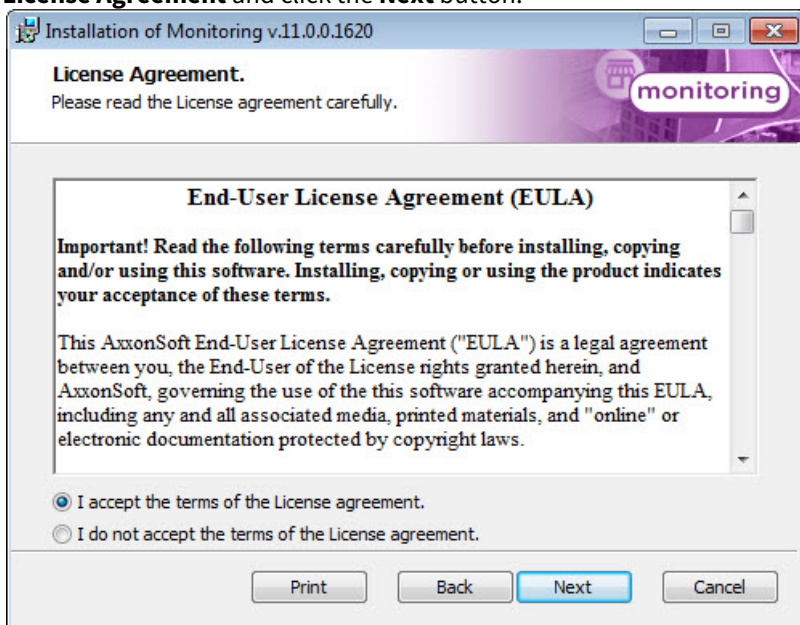

3. Set the **Agent of control** installation type. Click **Next**.

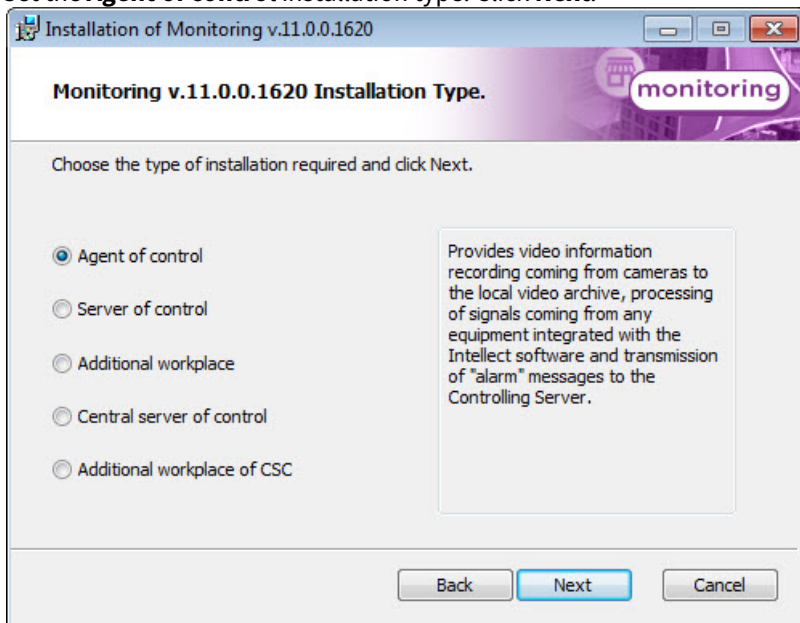

4. In the window that appears, select the most appropriate installation type. If Intellect is installed as a service, select the **Install Monitoring as a service** check box. The ITV Monitoring VRecover service will be configured and added to the system. Otherwise, clear the check box.

Click the **Next** button.

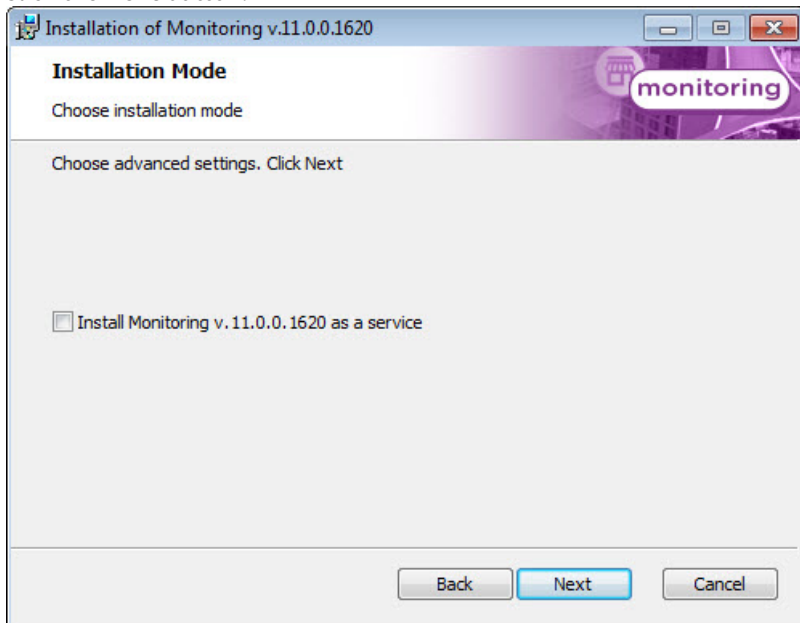

5. A dialog box to confirm installation will be displayed. Click **Install** to run installation process.

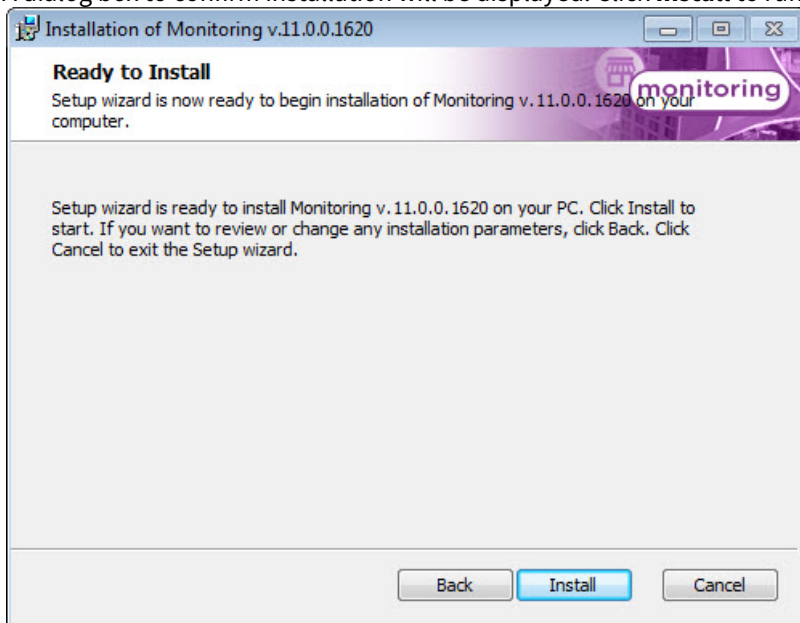

6. The installation process is started.

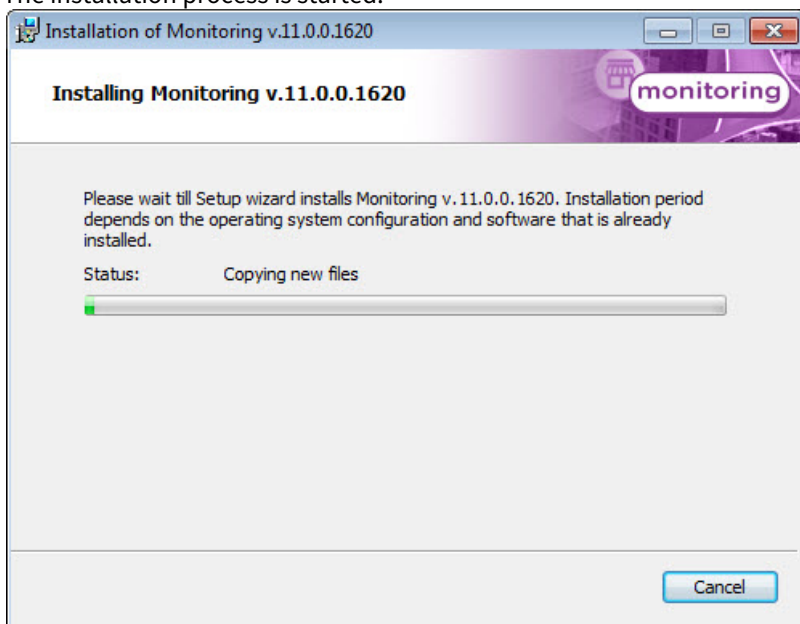

7. When installation is complete, a wizard page appears with a message about successful installation. Click the **Finish** button.

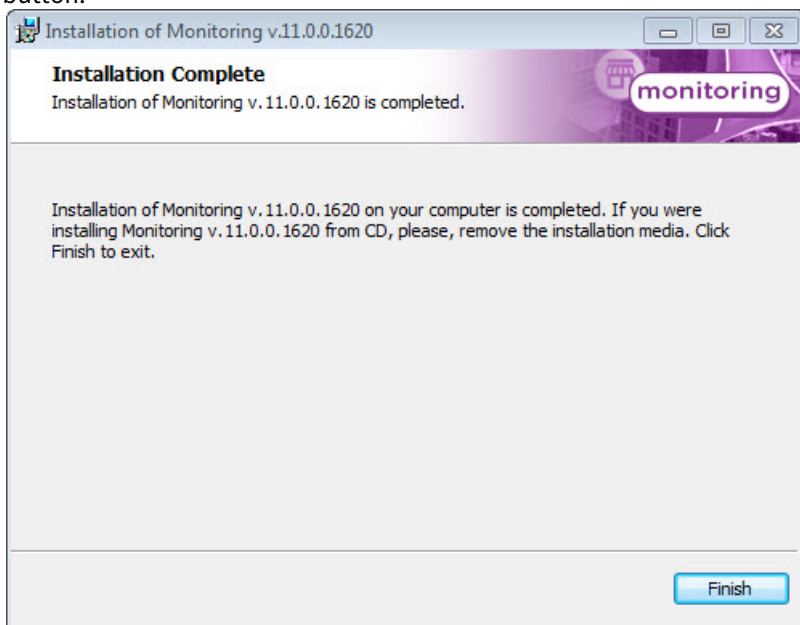

Installation of *Agent of control* is now complete.

4.4.2 Server of control Installation

Installation of *Server of control* software is performed in the following sequence:

1. From the installation kit, start the executable file setup.exe. A dialog box appears, informing of the beginning of installation. A prompt to start installation then appears. Click the **Next** button.

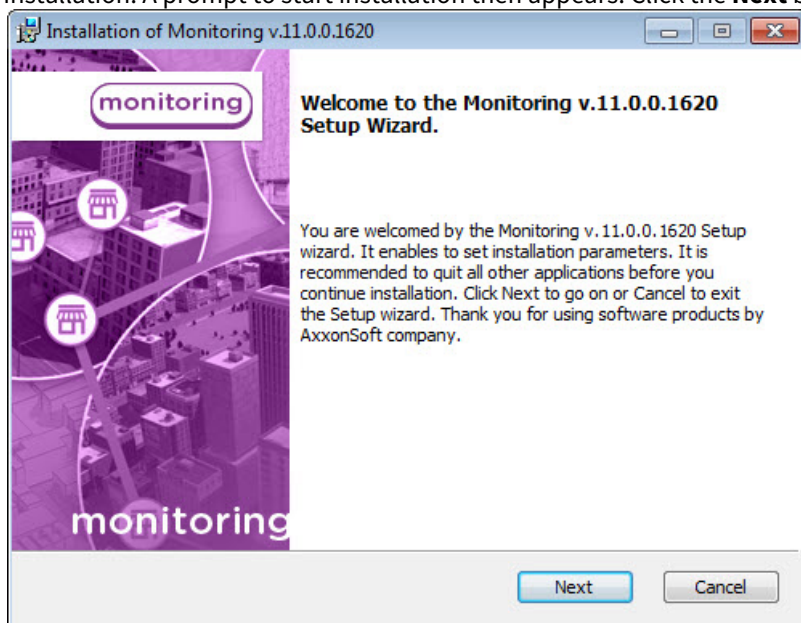

2. The **License Agreement** window presents the terms of the end user license agreement. Select **I accept the terms of the License Agreement** and click the **Next** button.

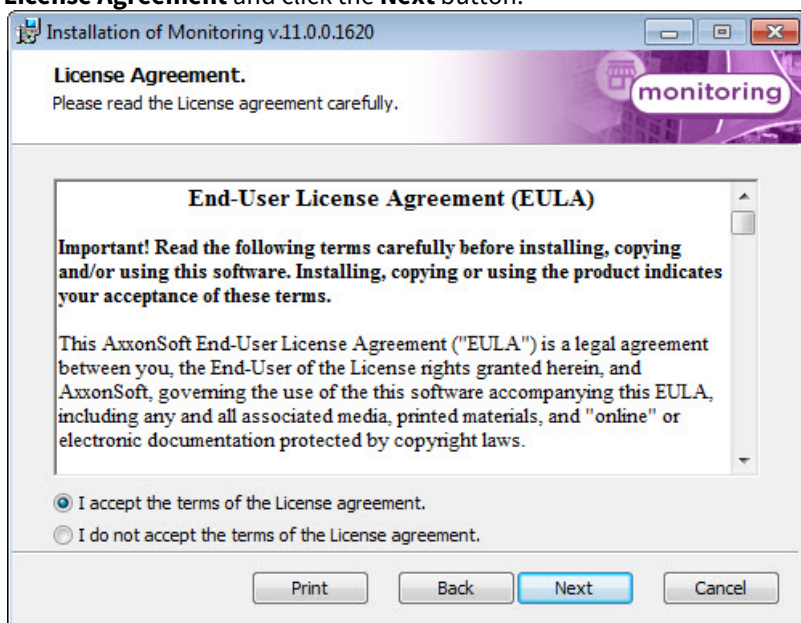

3. Set the **Server of control** installation type. Click **Next**.

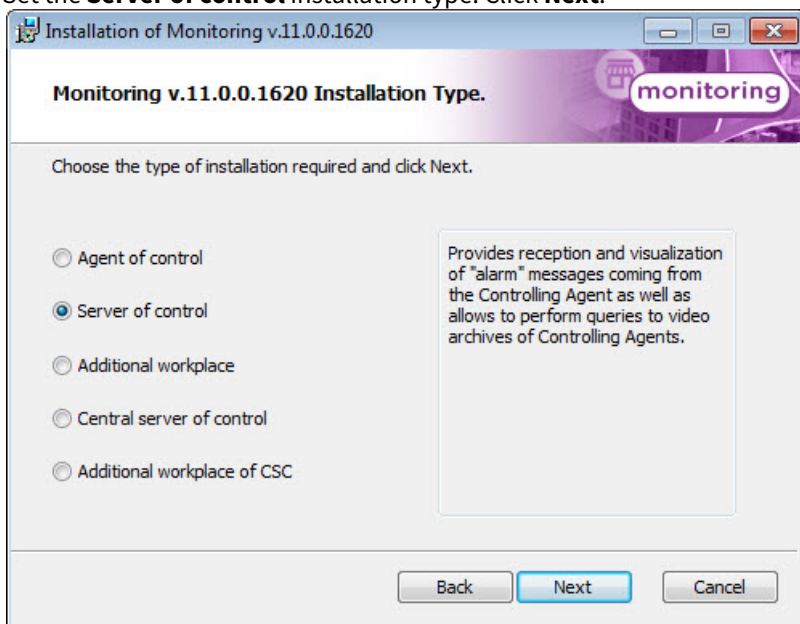

4. In the window that appears, select the most appropriate installation type. If Intellect is installed as a service, select the **Install Monitoring as a service** check box.

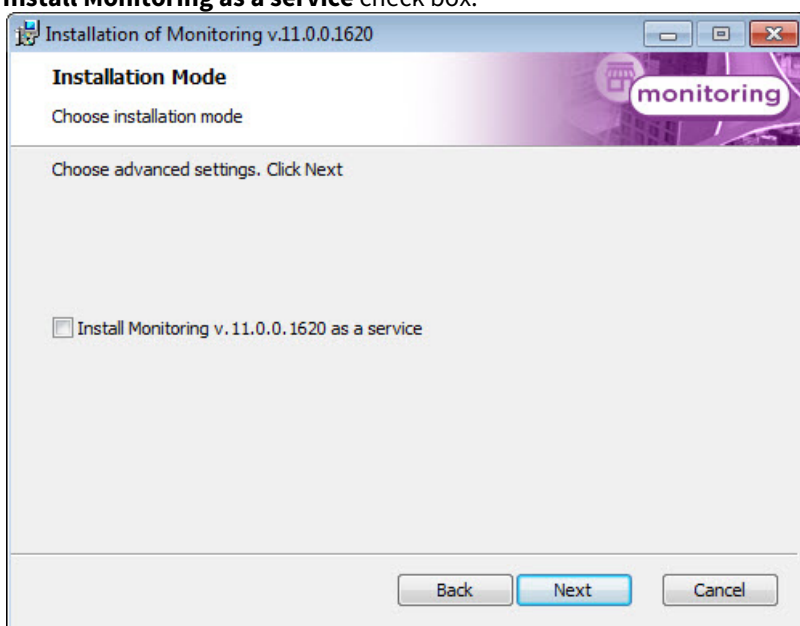

5. A dialog box to configure database connection will be displayed. Select the database server name and set up the connection parameters. Click **Next**.

Note.

In the **Select database Server from the drop-down list** field specify the "127.0.0.1" value instead of computer name or "(local)" value, e.g. "127.0.0.1\SQLEXPRESS". Otherwise *Server of control* will lose connection with its local database when the network cable is disconnected.

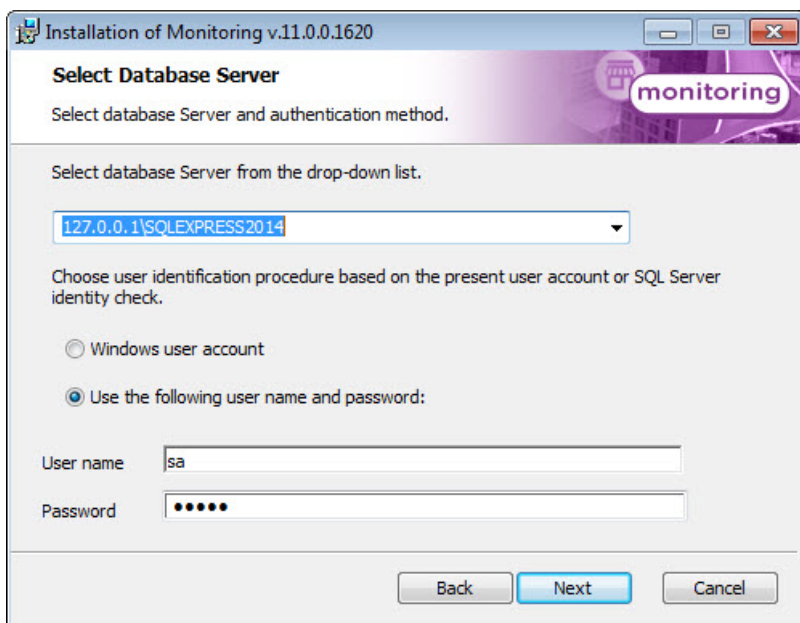

6. In the **Database** field specify the name of the database or select it in the list of databases, which are created in the server, and click <<.

Click **Next**

Note.

By default, the name of the database is "MonitorSSTV" and its files will be stored in the SQL Server folder.

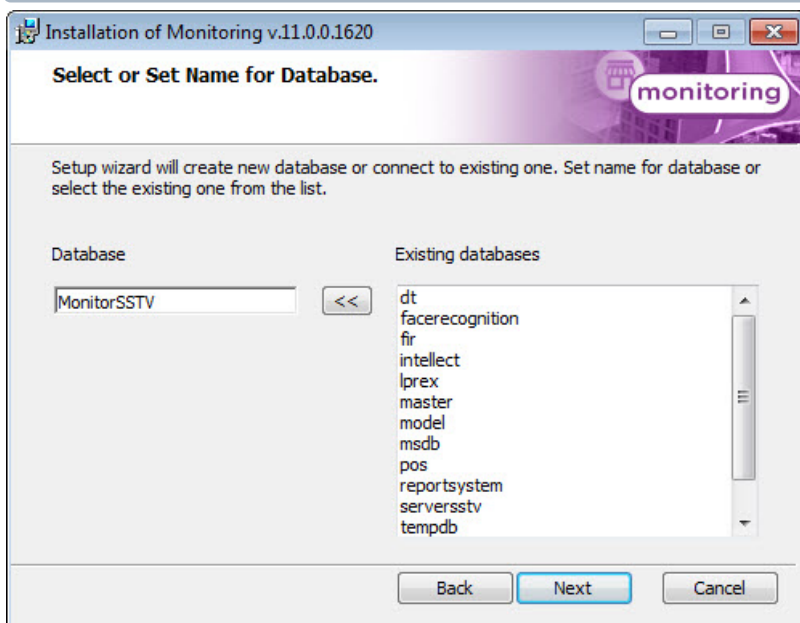

7. Click **Install** on the next dialog box.

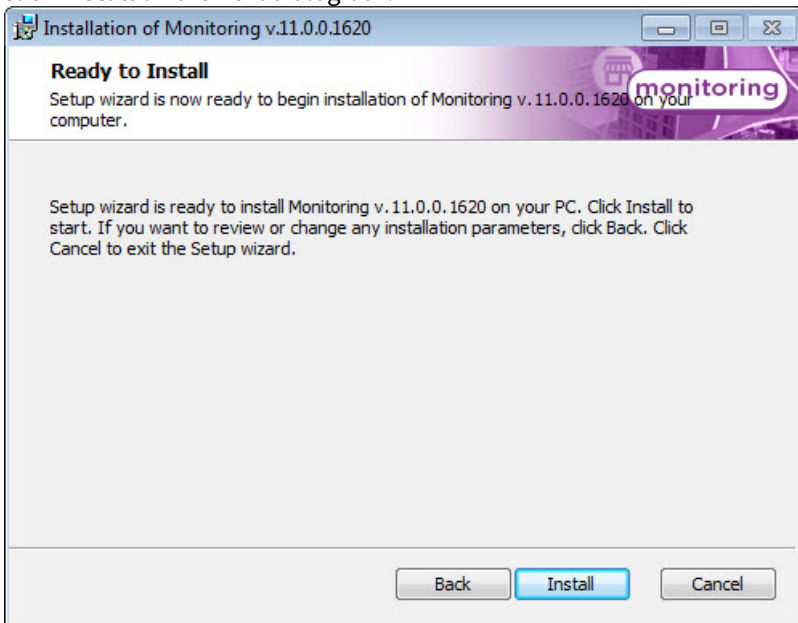

8. The installation process is launched.

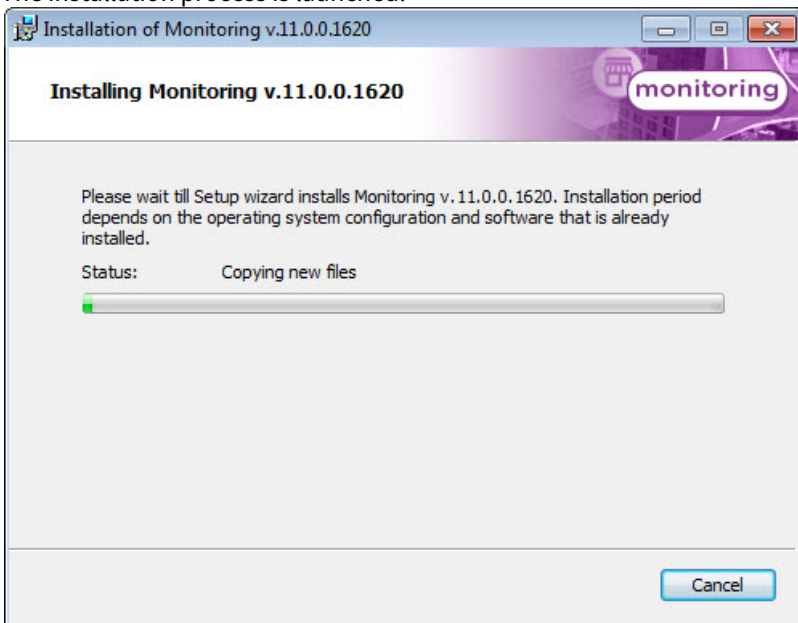

- When installation is complete, a wizard page appears with a message about successful installation. Click **Finish**.

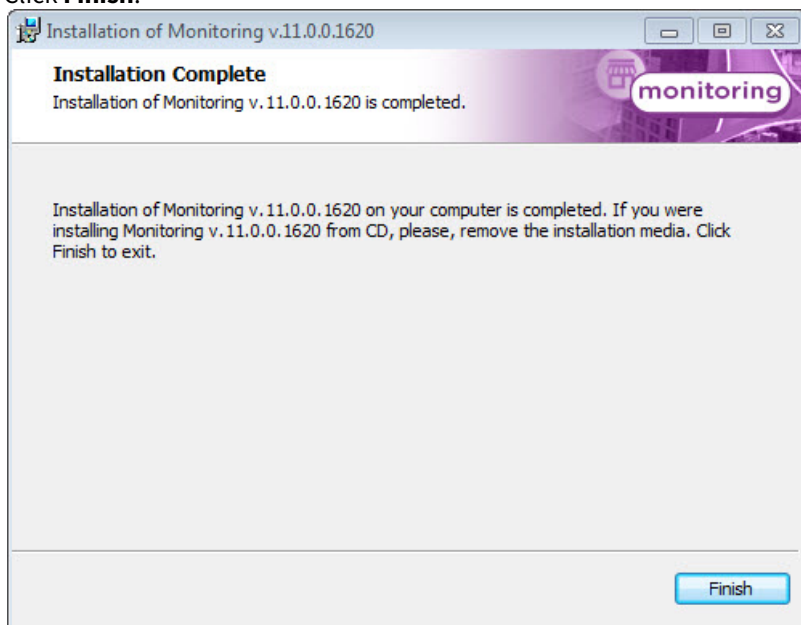

Installation of *Server of control* is complete.

4.4.3 Additional workplace Installation

Installation of *Additional workplace* software is performed in the following sequence:

- From the installation kit, start the executable file setup.exe. A dialog box appears, informing of the beginning of installation. A prompt to start installation then appears. Click the **Next** button.

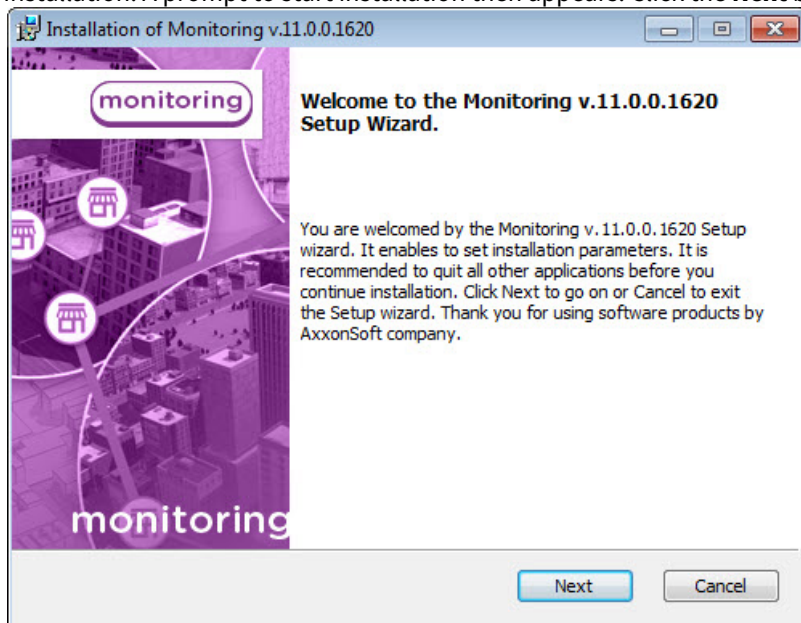

2. The **License Agreement** window presents the terms of the end user license agreement. Select **I accept the terms of the License Agreement**. Click the **Next** button.

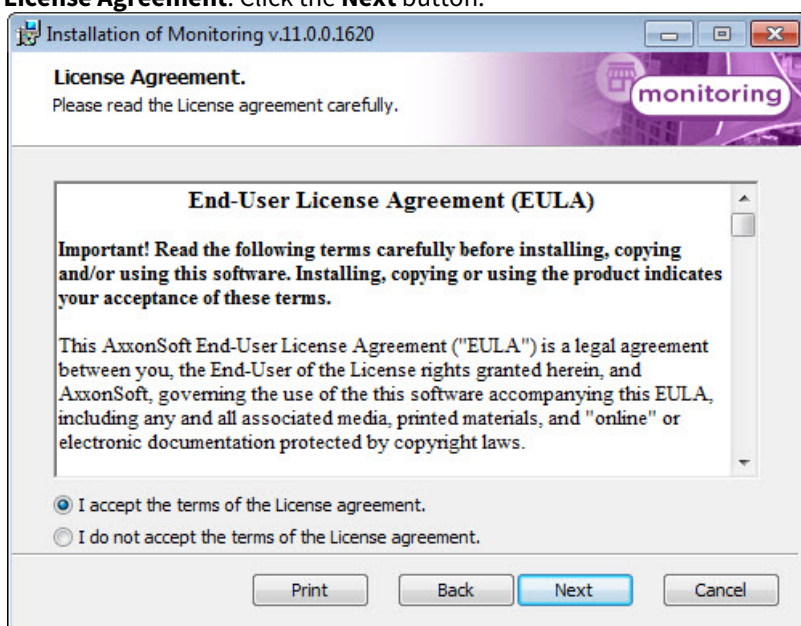

3. On the next screen, select the **Additional workplace** installation type. Click **Next**.

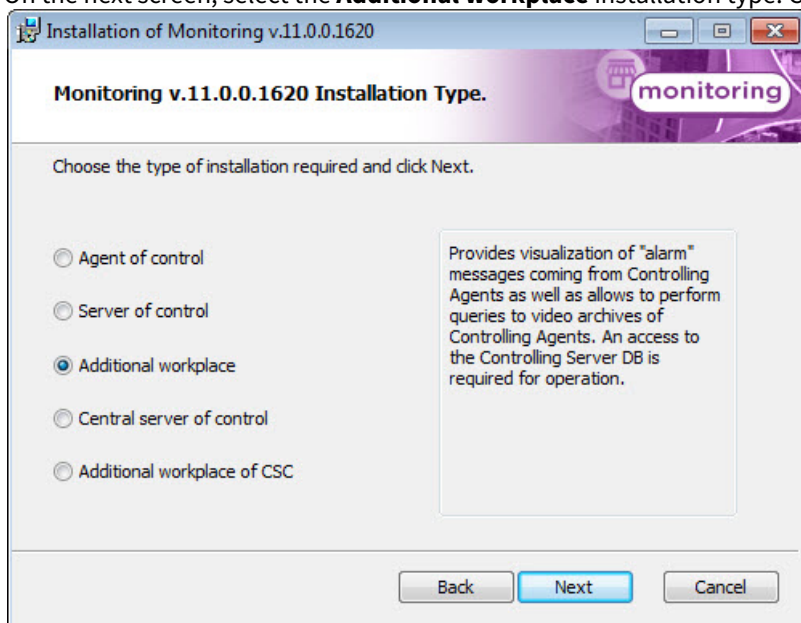

4. A dialog box to configure database connection will be displayed. Select the database server name and set up the connection parameters.

Click **Next**.

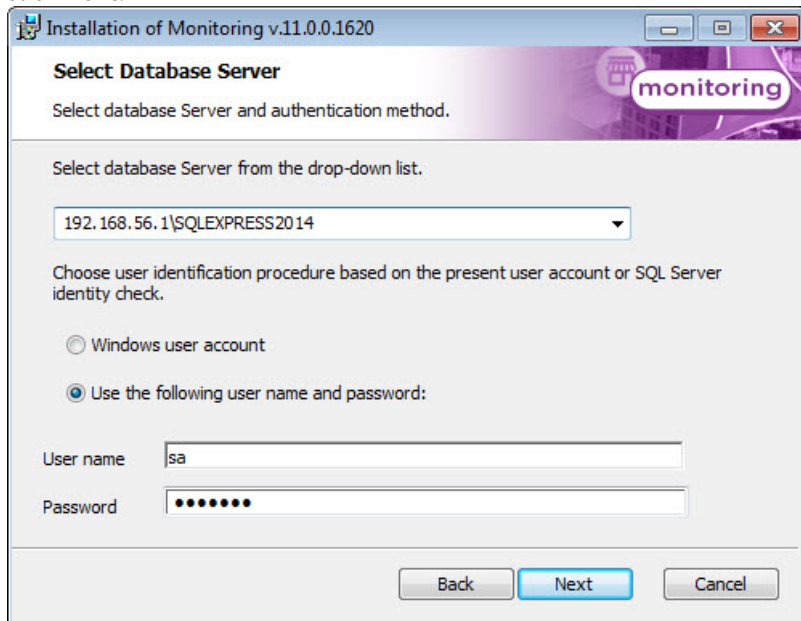

5. In the **Database** field specify the name of existing database or select it in the list of databases, which are created in the server, and click <<.

Click **Next**.

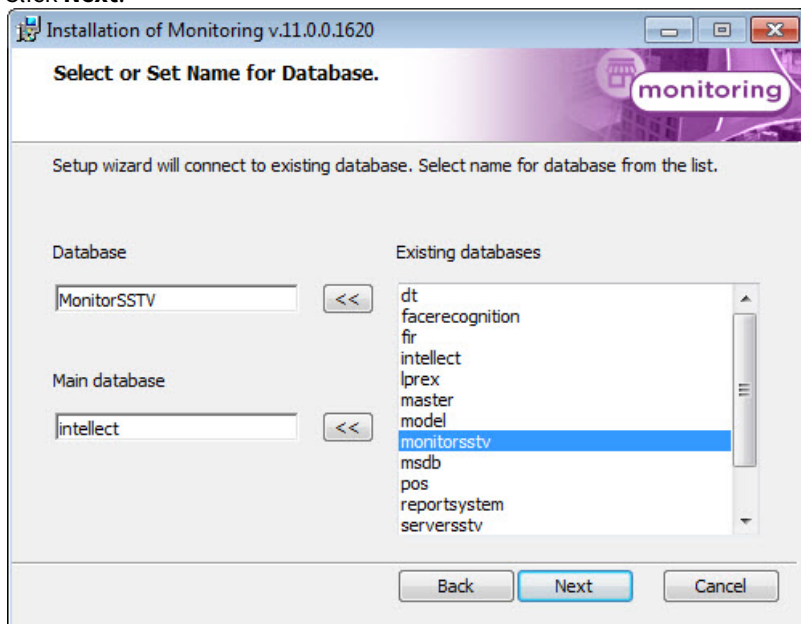

6. Specify the export catalog path. This catalog will contain video data received from *Agent of Control*. Click **Next**.

Installation of Monitoring v.11.0.0.1623

Choose Export Folder.
Choose where to set Monitoring v. 11.0.0. 1623 export catalog.

Monitoring v. 11.0.0. 1623 export catalog will be set to the following folder.

Export catalog path

\\Server\Export

7. Specify IP-address and port for connection to *Server of Control* communication module videosrv. Click **Next**.

Installation of Monitoring v.11.0.0.1623

Setting up connection to communication module.
Please input ip address and port.

Connection to communication module would be set according to the following values.

Videosrv settings

IP address
192.168.56.1

Port
7755

Note.

It is strongly recommended to change default **Export catalog path** and **IP address** on steps 6-7. Otherwise, after the installation is completed, it will be necessary to configure Additional workplace (see [Configuring Additional workplace](#)).

- 8. Click **Install** on the next dialog box.

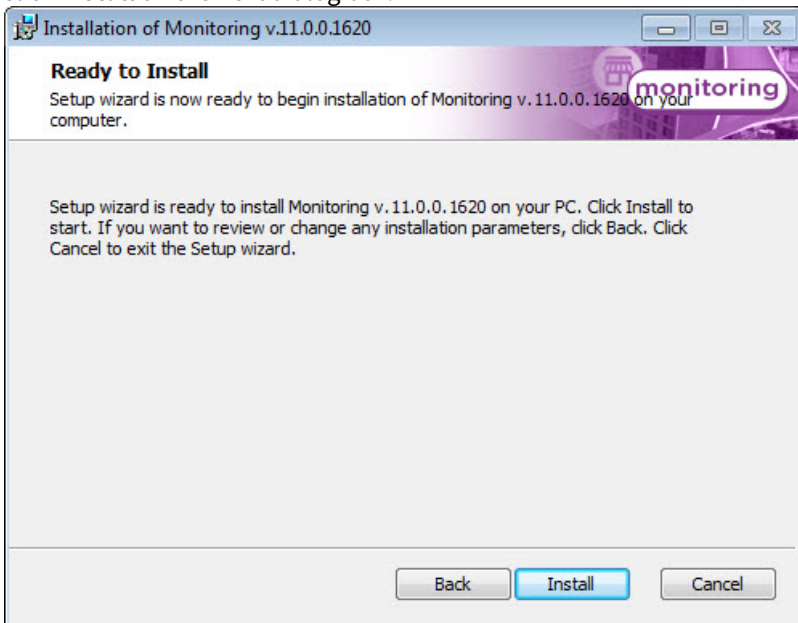

- 9. The installation process is launched.

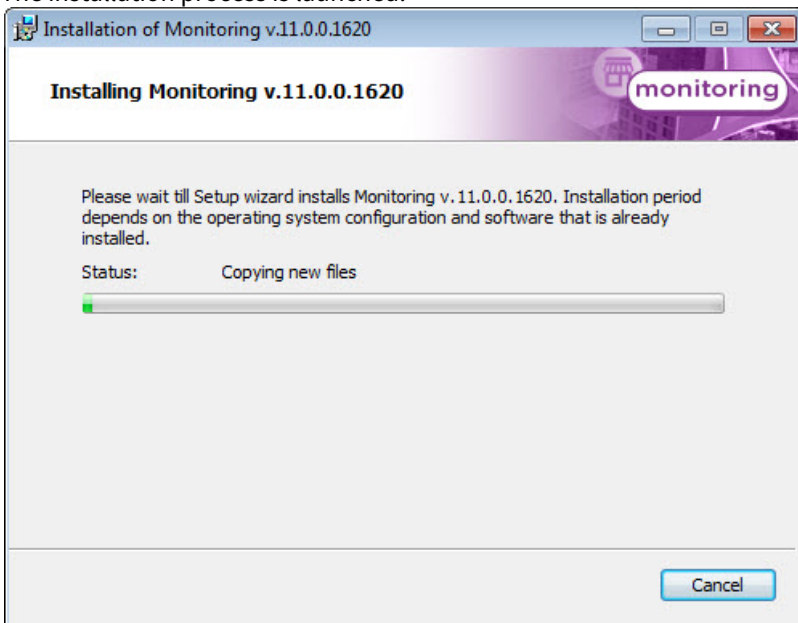

- When installation is complete, a wizard page appears with a message about successful installation. Click the **Finish** button.

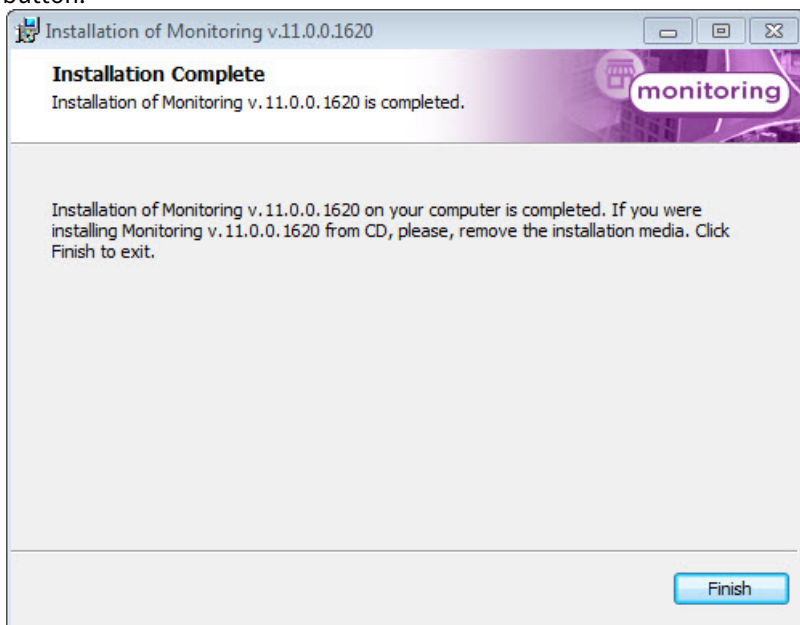

Installation of *Additional workplace* software is complete.

4.4.4 Central server of control installation

Installation of *Central server of control* software is performed in the following sequence:

- From the installation kit, start the executable file setup.exe. A dialog box appears, informing of the beginning of installation. A prompt to start installation then appears. Click the **Next** button.

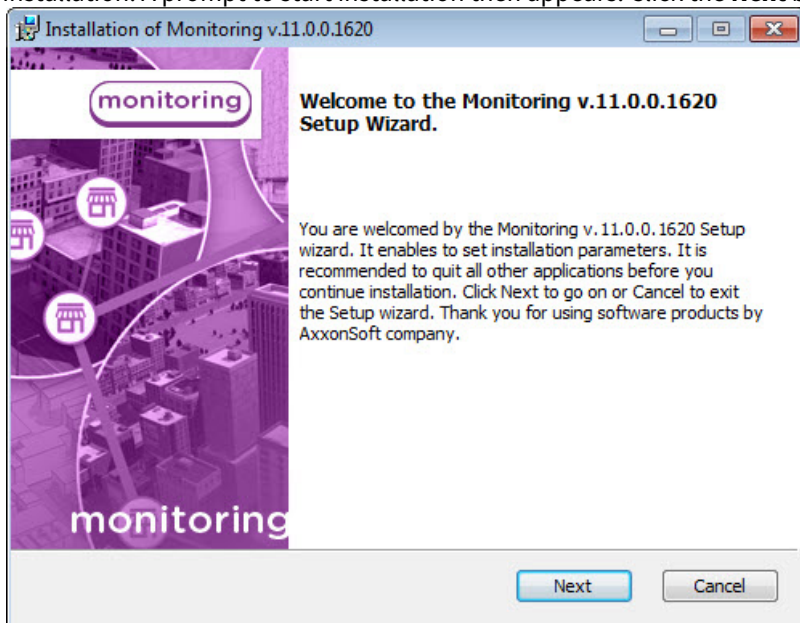

- The **License Agreement window** presents the terms of the end user license agreement. Select **I accept the terms of the License Agreement** and click the **Next** button.

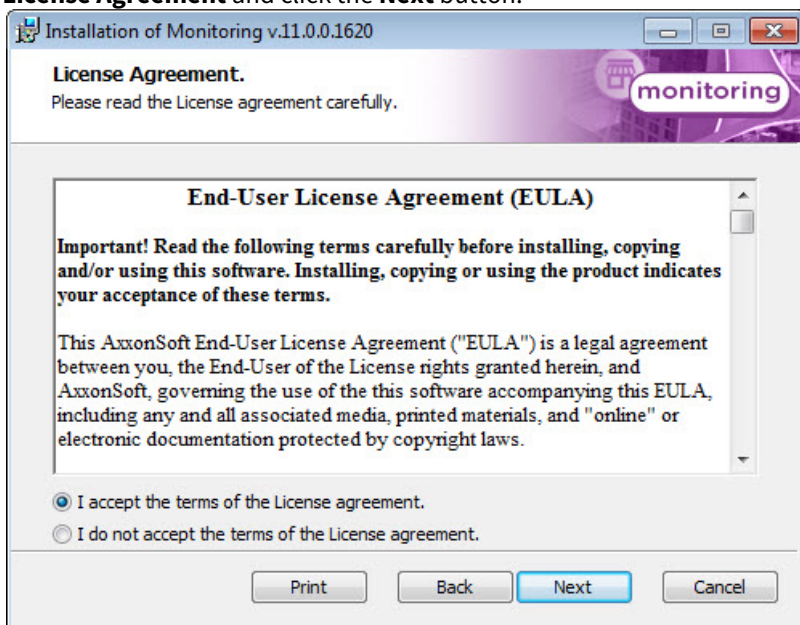

- Set the **Central server of control** installation type. Click **Next**.

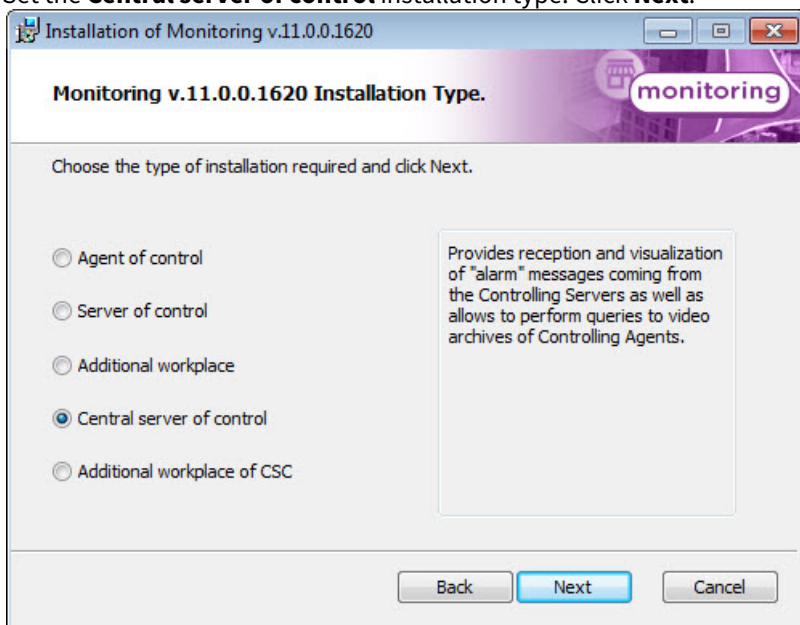

4. In the window that appears, select the most appropriate installation type. If *Intellect* is installed as a service, select the **Install Monitoring as a service** check box. Click **Next**.

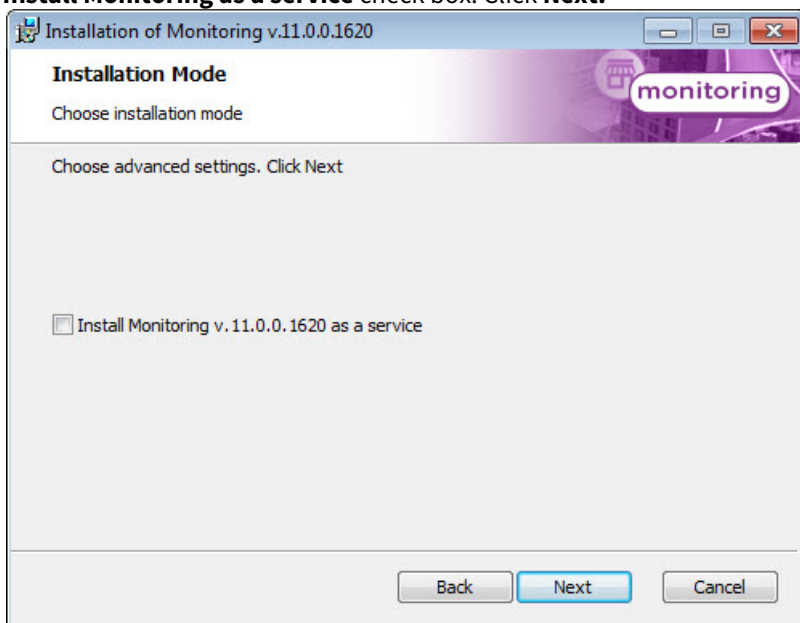

5. A dialog box to configure database connection will be displayed. Select the database server name and set up the connection parameters. Click **Next**.

Note

In the **Select database Server from the drop-down list** field specify the **127.0.0.1** value instead of computer name or "(local)" value. Otherwise *Central server of control* will lose connection with its local database when the network cable is disconnected.

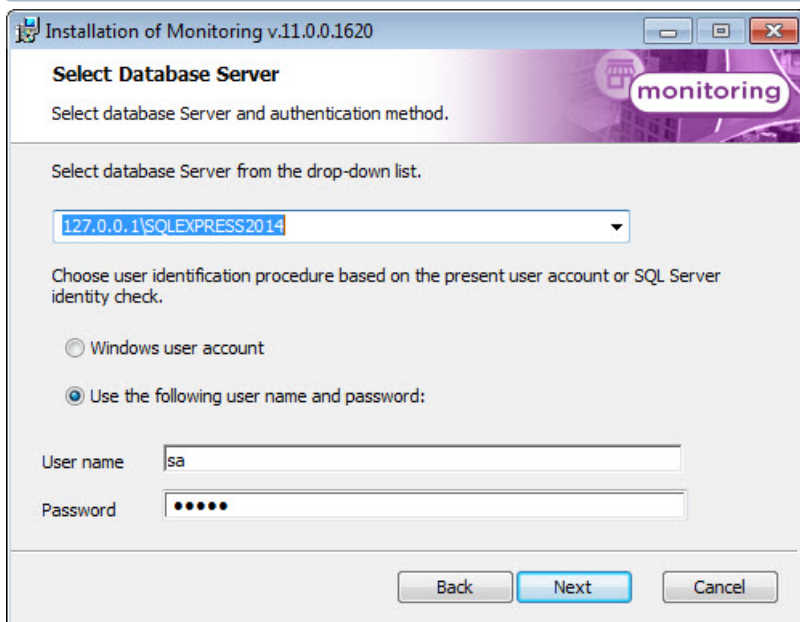

6. In the **Database** field specify the name of the database or select it in the list of databases, which are created in the server, and click <<. Click **Next**.

Note

By default, the name of the database is "ServerSSTV" and its files will be stored in the SQL Server folder.

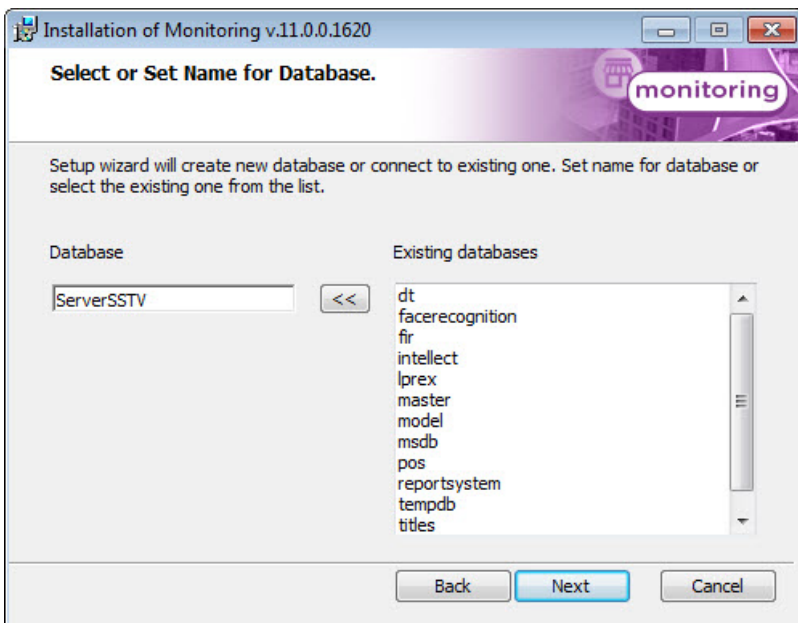

7. Click **Install** on the next dialog box.

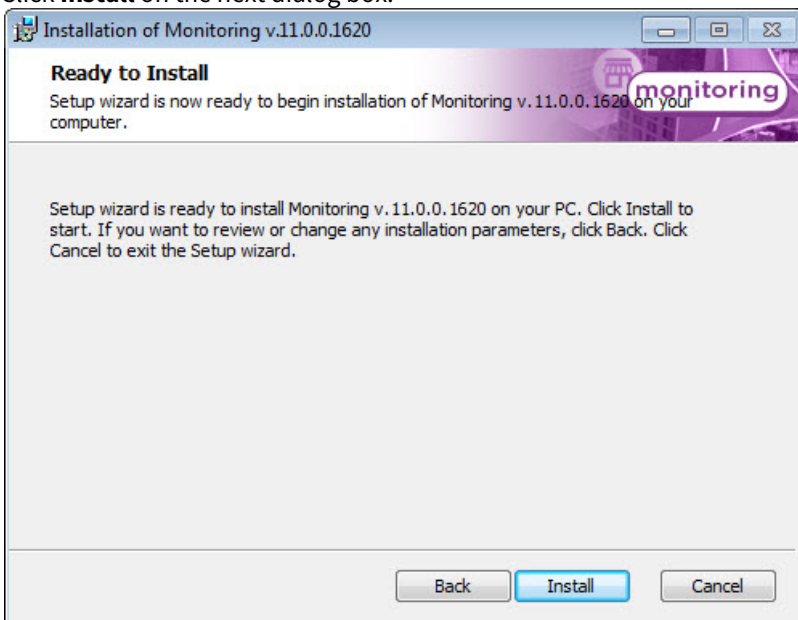

8. The installation process is launched.

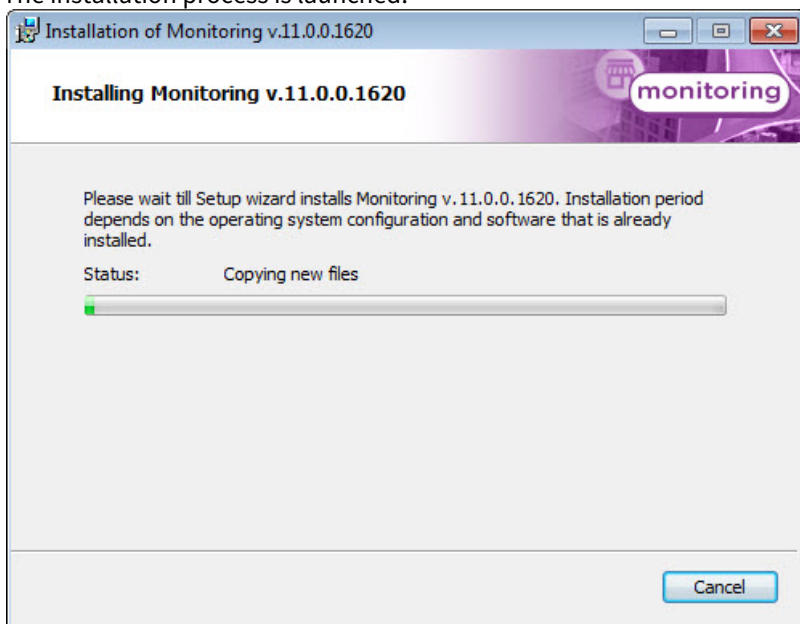

9. When installation is complete, a wizard page appears with a message about successful installation. Click **Finish**.

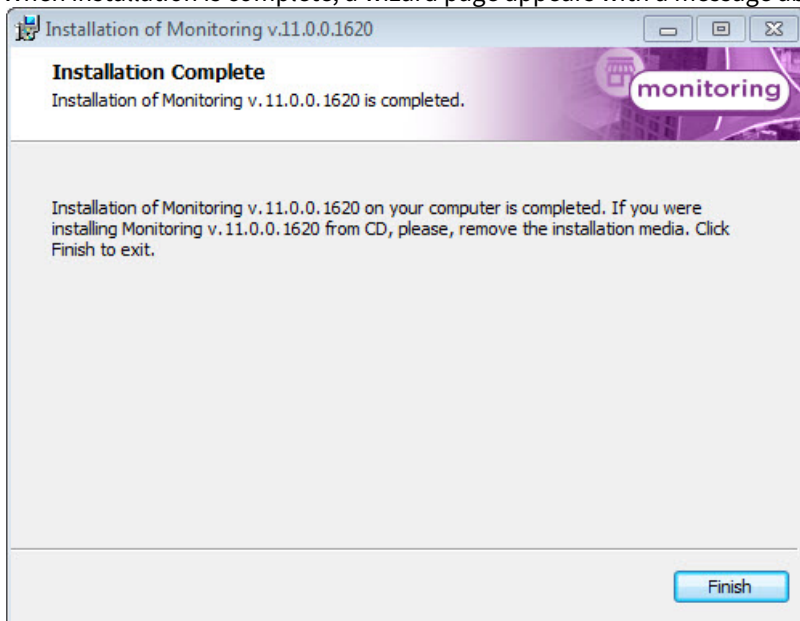

Installation of *Central server of control* software is complete.

4.4.5 Additional workplace of CSC Installation

Installation of *Additional workplace of CSC* software is performed in the following sequence:

1. From the installation kit, start the executable file setup.exe. A dialog box appears, informing of the beginning of installation. A prompt to start installation then appears. Click the **Next** button.

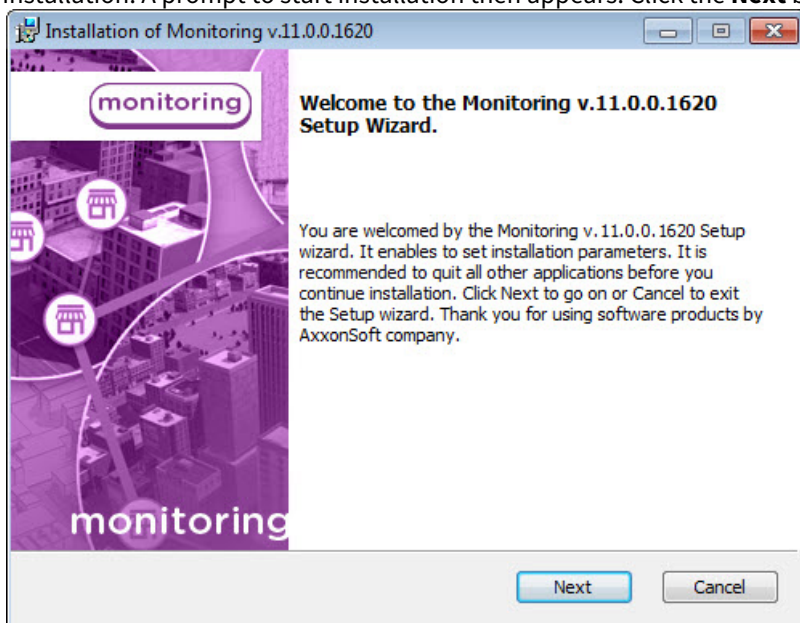

2. The **License Agreement** window presents the terms of the end user license agreement. Select **I accept the terms of the License Agreement**. Click the **Next** button.

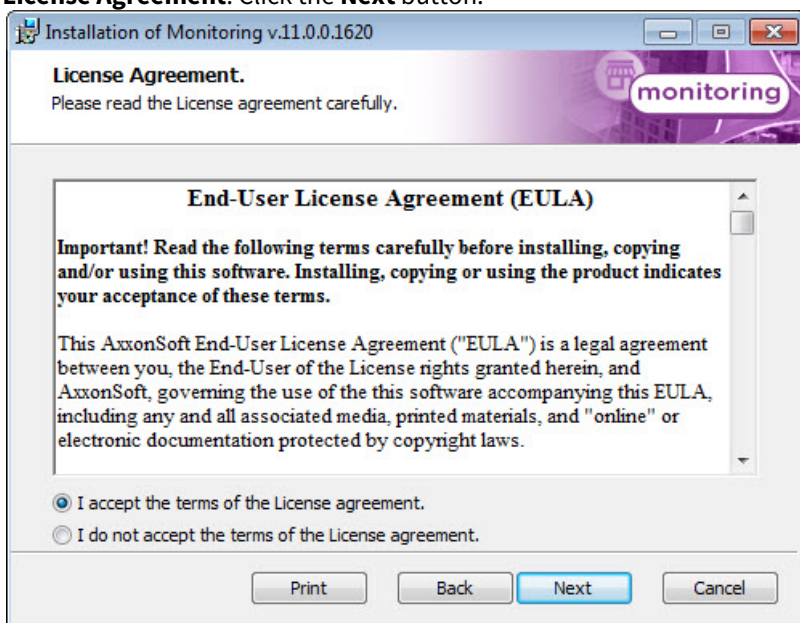

3. On the next screen, select the **Additional workplace of CSC** installation type. Click **Next**.

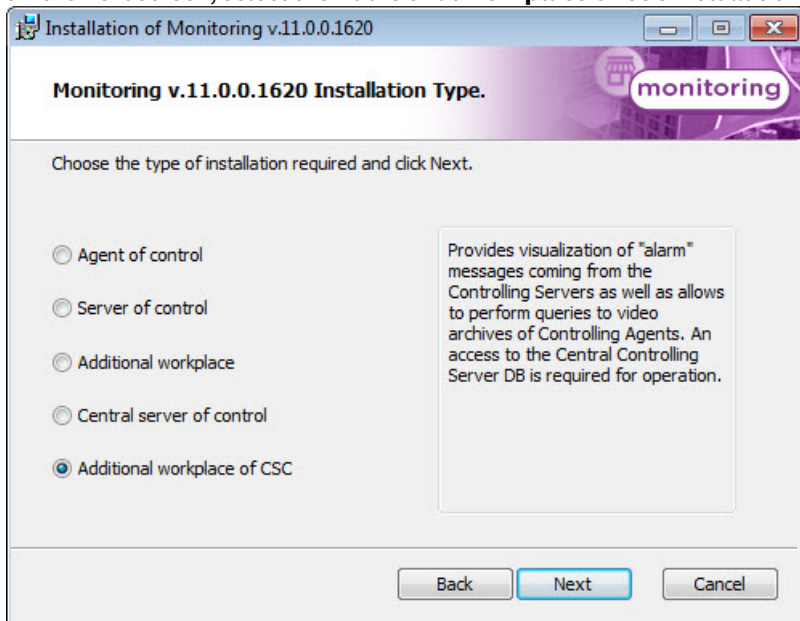

4. A dialog box to configure database connection will be displayed. Select the database server name and set up the connection parameters. Click **Next**.

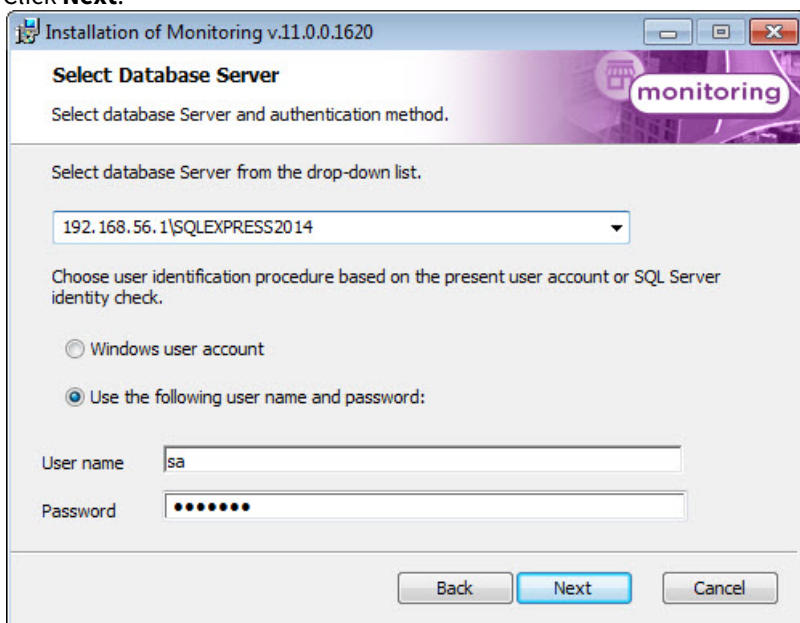

5. In the **Database** field specify the name of existing database or select it in the list of databases, which are created in the server, and click <<.

Click **Next**.

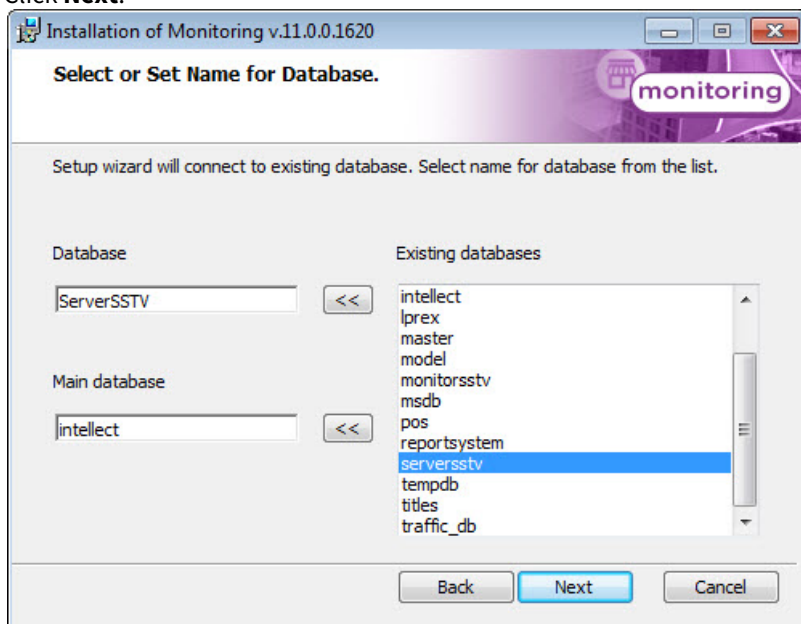

6. Specify the export catalog path. This catalog will contain video data received from *Agent of Control*. Click **Next**.

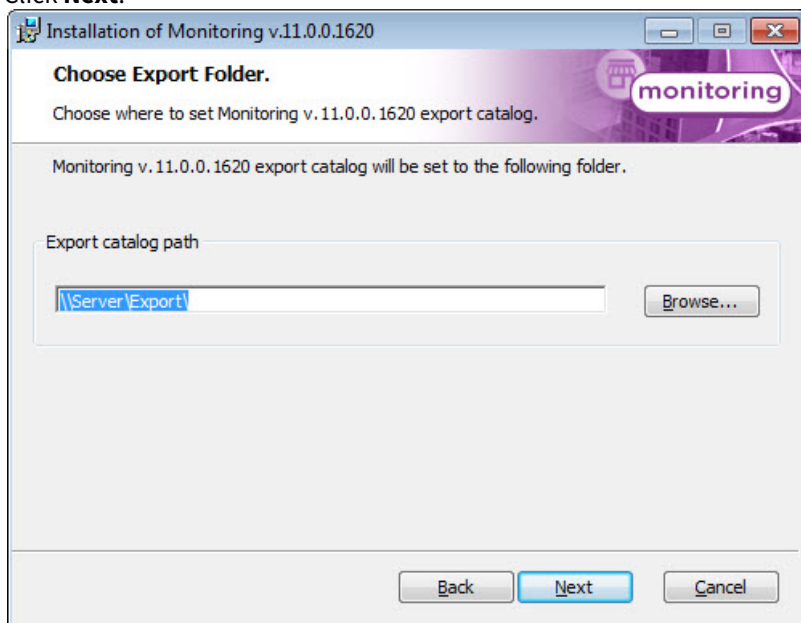

7. Specify IP-address and port for connection to *Central server of control* communication module CentralNetServer. Click **Next**.

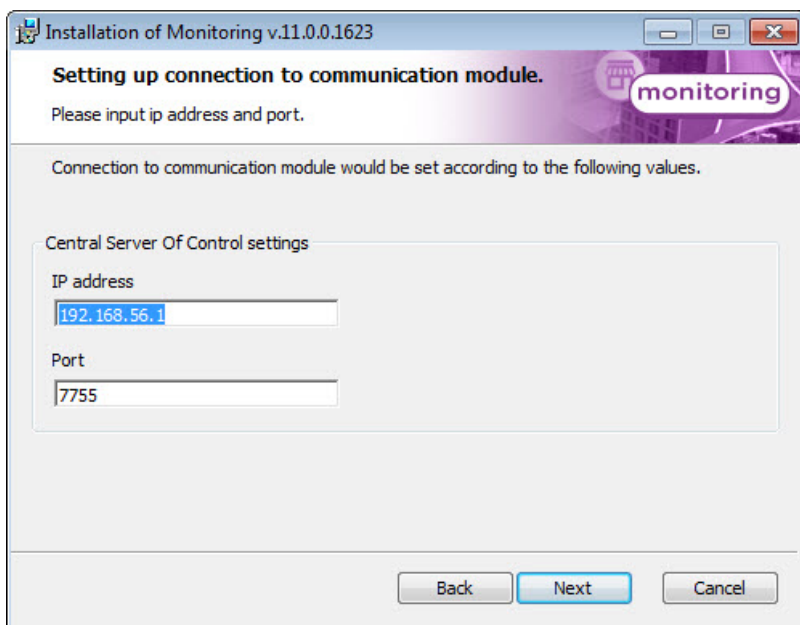

Note.

It is strongly recommended to change default **Export catalog path** and **IP address** on steps 6-7. Otherwise, after the installation is completed, it will be necessary to configure Additional workplace (see [Configuring Additional workplace](#)).

8. Click **Install** on the next dialog box.

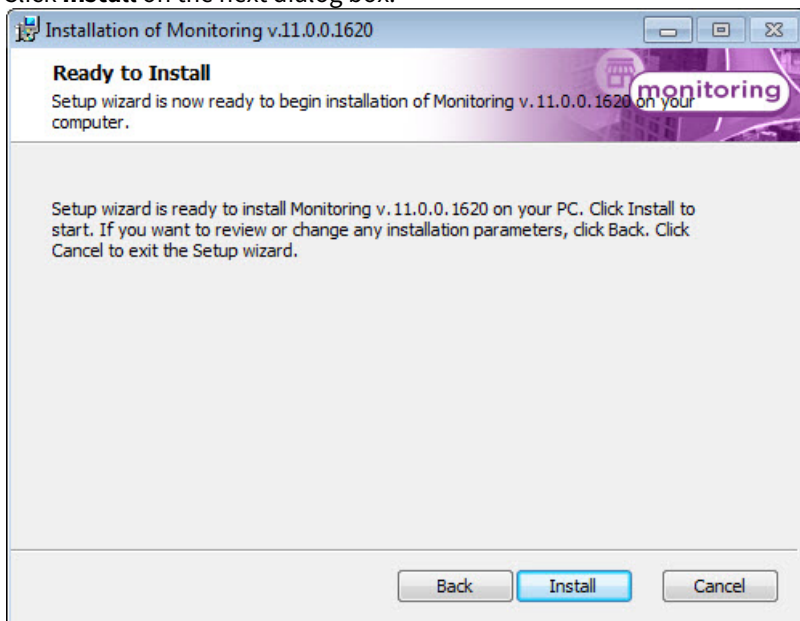

9. The installation process is launched.

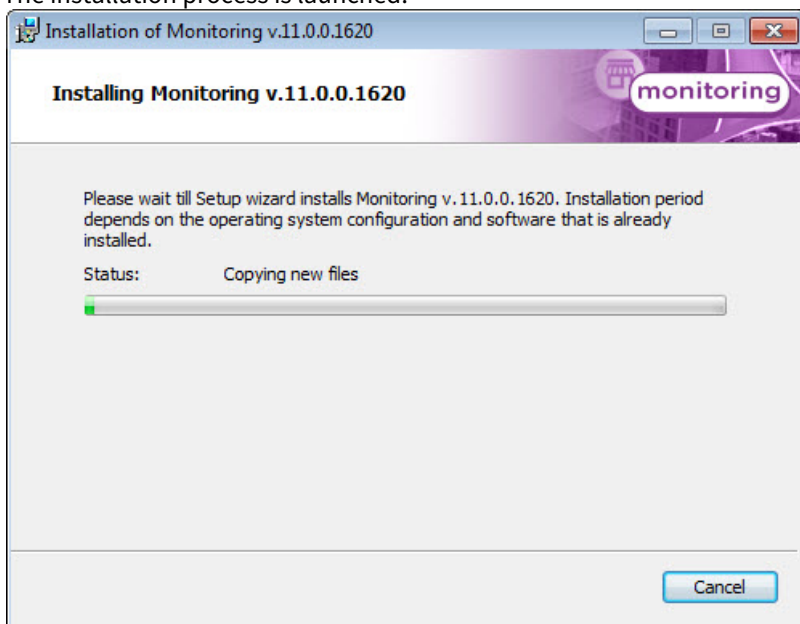

10. When installation is complete, a wizard page appears with a message about successful installation. Click the **Finish** button.

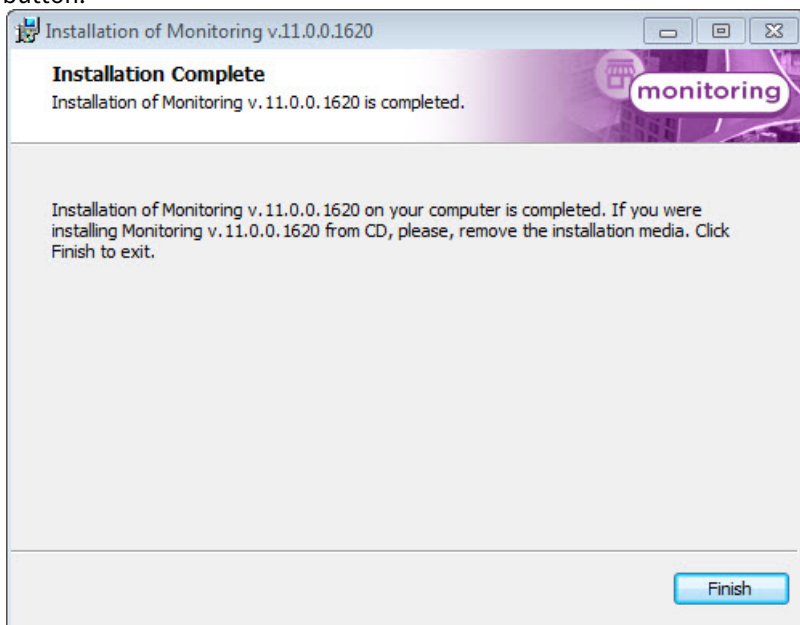

Installation of *Additional workplace of CSC* software is complete.

5 Configuring Agent of Control

To configure Agent of Control, go to the **System settings** window. Use of this window is described in [Intellect Software Package: Administrator's Guide](#).

5.1 Creating necessary Agent of Control objects

Note.

Agent of Control, as well as *Server of Control*, can operate in distributed architecture of the digital video surveillance system. In this case both *Server of Control* and *Agent of Control* shall be configured locally, not remotely. *Agents of Control* can view each other in the distributed configuration but cannot change each other's settings. *Agents of Control* cannot view *Servers of Control* while *Servers of Control* can view where *Agents of Control* are installed.

Attention!

Every time *Agent of Control* is started, it checks for a **Backup** folder at the root of the disk on which *Intellect* is installed. If this folder is missing, *Agent of Control* creates it. Do not delete this folder.

To create necessary *Agent of Control* objects in the device tree:

1. In the **System settings** window, go to the **Hardware** tab (1).
2. Create an **IIDK interface** object based on a **Computer** object (2). Set the ID of the **IIDK interface** object (3).

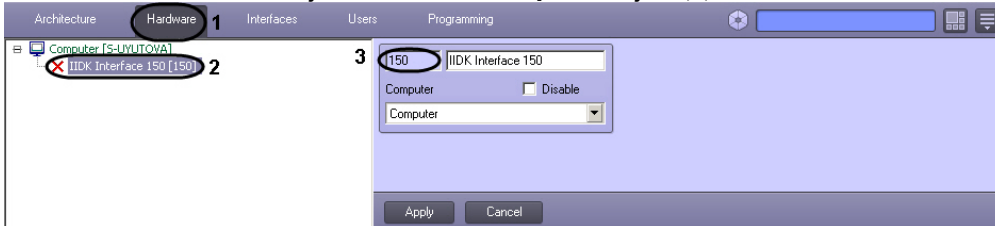

3. Create an **Agent of Control** object based on a **Computer** object.

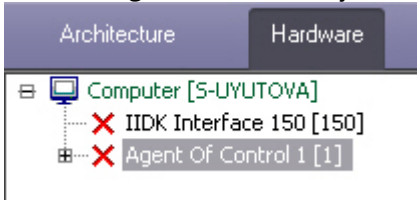

4. After an **Agent of Control** object is created in the right part of the **System settings** window, a panel appears for configuring the object.



5. In the **IIDK Interface No.** field, enter the object ID for the **IIDK interface** created in step 2.

6. Create one or more child **Partition Of Control** objects based on the **Agent of Control** object.

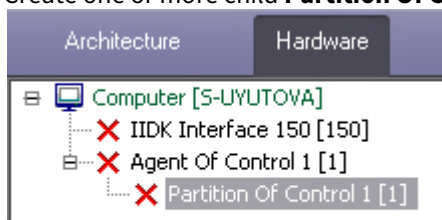

⚠ Important!

The identification number of **Partition of Control** object shall not include any symbols except digits, otherwise events are not transmitted from such object to *Server of Control*.

7. After the **Partition Of Control** object is created in the right part of the **System settings** window, a panel appears for configuring the object.

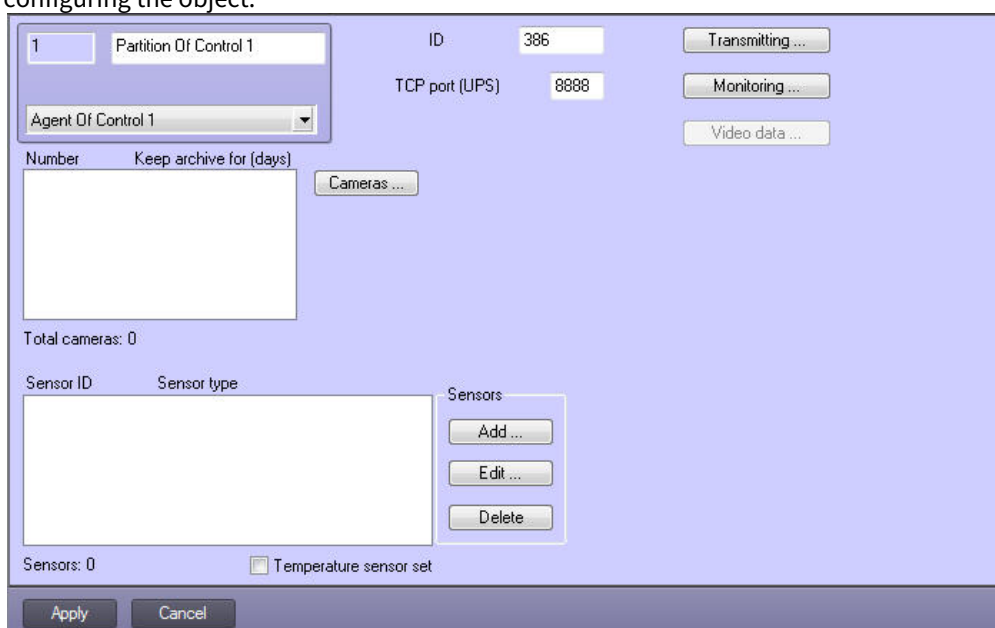

ⓘ Note.

It is also necessary to create **Video capture device**, **Camera**, and **Sensor** objects in the device tree that correspond to the connected hardware. Creation and configuration of these objects is described in the document *Intellect Software Package: Guide to Installation and Configuration of Security System Components* (the most recent version of this document can be found in the [documentation repository](#)).

Creation of the necessary objects in the device tree is now complete.

5.2 Configuring the logging subsystem

The logging subsystem allows configuring the detail level at which the activity of *Agent of Control* is recorded.

To configure the logging subsystem:

1. Go to the configuration panel for an **Agent of Control** object.



2. Click the **Logging subsystem...** button.
3. In the dialog box that opens, specify the following parameters:

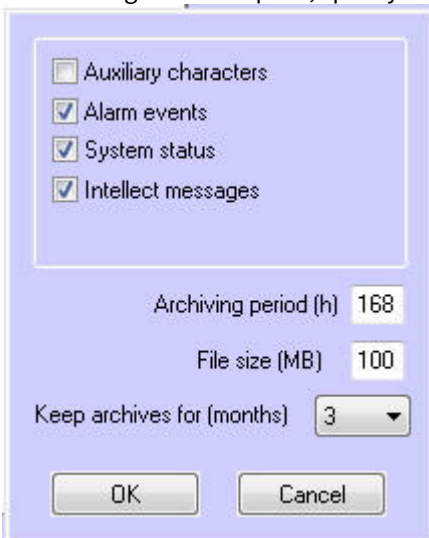

- a. **Auxiliary characters:** To log transport-level auxiliary characters, select this check box.
- b. **Alarm events:** To log alarms (activation of vibration sensor, temperature sensor, or forcible entry sensor), select this check box.
- c. **System status:** To log events related to the system state, select this check box.
- d. **Intellect messages:** To log messages from Intellect, select this check box. Information is saved in the folder to which the software was installed, in the file video.log.
- e. **Archiving period (h):** Allows archiving the log file at the specified interval (in hours). Archives are saved in the DATA subfolder, with the following name format: `namelog_yymmddhhmmss.gz`, where
 - i. `namelog` is the name of the log file being archived;
 - ii. `yy` is the year of archive creation;
 - iii. `mm` is the month of archive creation;
 - iv. `dd` is the day of archive creation;
 - v. `hh` is the hour of archive creation;
 - vi. `mm` is the minute of archive creation;
 - vii. `ss` is the second of archive creation.
- f. **File size (MB):** Sets the threshold size (in megabytes) for the log file after which the file is archived. This setting overrides the value in the **Archive period (h)** field.
- g. **Keep archives for (months):** Sets the length of time for which to store the log file archive, in months (between 1 and 24). Archives that are older than the specified number of months are deleted.

The main log file is located in the installation folder, in the file `vsvrYYMMDD.log`, where `YY` is the year, `MM` the month, and `DD` the day.

Configuration of the logging subsystem is now complete.

5.3 Configuring the Partition Of Control object

5.3.1 Configuring the Partition Of Control unique ID

To configure the unique ID number for a Partition Of Control:

1. Go to the configuration panel for the **Partition Of Control** object.

The screenshot shows the configuration panel for a Partition Of Control object. The 'ID' field is highlighted with a red box and contains the value '386'. Other fields include 'Agent Of Control 1' (set to 'Agent Of Control 1'), 'TCP port (UPS)' (set to '8888'), and a 'Cameras' section with a table for adding cameras. There are also buttons for 'Transmitting...', 'Monitoring...', and 'Video data...'. At the bottom, there are 'Apply' and 'Cancel' buttons.

2. In the **ID** field, enter a unique number for the object on which *Agent of Control* is being installed. The number can be from 3 to 9 symbols long.
To save settings, click the **Apply** button.

Configuration of a unique Partition Of Control ID number is now complete.

5.3.2 Configuring a port for incoming UPS messages

To configure a port for accepting messages from an uninterrupted power supply unit:

1. Go to the configuration panel for the **Partition Of Control** object.

The screenshot shows the configuration panel for a Partition Of Control object. The 'TCP port (UPS)' field is highlighted with a red box and contains the value '8888'. Other fields include 'ID' (set to '386'), 'Agent Of Control 1' (set to 'Agent Of Control 1'), and a 'Cameras' section with a table for adding cameras. There are also buttons for 'Transmitting...', 'Monitoring...', and 'Video data...'. At the bottom, there are 'Apply' and 'Cancel' buttons.

2. In the **TCP port (UPS)** field, enter the number of the port on which to "listen" for UPS messages.

3. To save settings, click the **Apply** button.

Configuration of a port for accepting messages from a UPS is now complete.

5.3.3 Configuring communication between Agent of Control and Server of Control

To configure communication between *Agent of Control* and *Server of Control*:

1. Go to the configuration panel for the **Partition Of Control** object.

The screenshot shows the configuration panel for a 'Partition Of Control' object. The panel has a light blue background and contains the following elements:

- Object Name:** '1 Partition Of Control 1' (text field)
- ID:** '386' (text field)
- Transmitting ...:** A button with a black border, highlighted by a red rectangle.
- Monitoring ...:** A button.
- Video data ...:** A button.
- TCP port (UPS):** '8888' (text field)
- Agent Of Control:** A dropdown menu showing 'Agent Of Control 1'.
- Cameras:** A table with columns 'Number' and 'Keep archive for (days)'. Below the table is a 'Cameras ...' button and the text 'Total cameras: 0'.
- Sensors:** A table with columns 'Sensor ID' and 'Sensor type'. To the right of the table are 'Add ...', 'Edit ...', and 'Delete' buttons. Below the table is the text 'Sensors: 0' and a checkbox labeled 'Temperature sensor set'.
- Buttons:** 'Apply' and 'Cancel' buttons at the bottom left.

- Click the **Transmitting...** button. A dialog box opens with settings for configuring the communication method between *Agent of Control* and *Server of Control*.

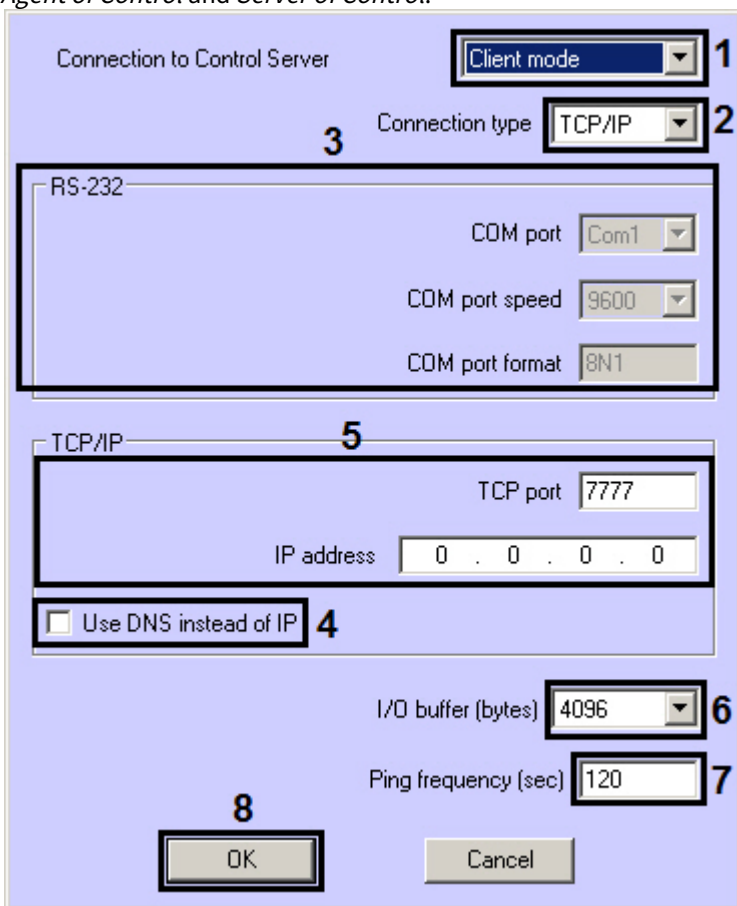

- In the **Connection to Server of Control** drop-down list select the **Client mode** as the methods for connecting *Agent of Control* to *Server of Control* (1).

Note.
The **Server mode** is not used.

- In the **Connection type** drop-down list, select one of the possible values for the transport level (2): **TCP/IP** or **RS232**.
- If **RS232** is selected in the **Connection type** field, specify values in the **COM port**, **COM port speed**, and **COM port format** fields (3).
- If **Client mode** is used to connect to *Server of Control* and **TCP/IP** is selected in the **Connection type** field, indicate the parameters for connection with *Server of Control* in this dialog box:
 - If an IP-address is used for connection, ensure the **Use DNS instead of IP** checkbox is not set (4) and indicate the **IP address** and **TCP port** of *Server of Control* (5).
 - If a domain name is used for connection, set the **Use DNS instead of IP** checkbox (1) and indicate the **DNS name** and **TCP port** of *Server of Control* (2).

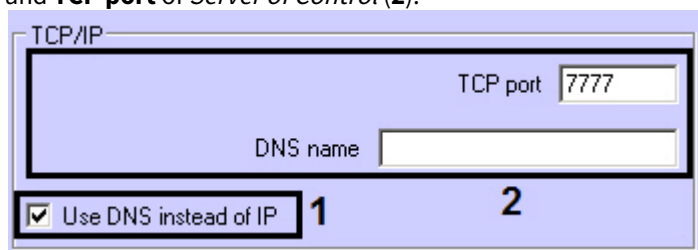

Note.

The use of domain name for connection allows to avoid *Agent of Control* resetting in case of *Server of Control* IP-address change.

7. When still frames or video is sent to *Server of Control*, the data is transferred in packets. The packet size is specified by the setting named **I/O buffer (bytes) (6)**. For maximum data transfer speed, you are advised to use the value 4096. For poor connections, such as if a GSM modem is used, you are advised to use the value 800.
8. In the **Ping frequency (sec.)** field, enter the time interval at which *Agent of Control* will send messages about its technical state to *Server of Control* (if **Client mode** is selected) (7). Minimal possible value is 10 sec. The value in the **Ping frequency (sec.)** field does not affect short-term alarms. Messages about short-term alarms are transmitted from *Agent of Control* to *Server of Control* immediately after corresponding sensors triggering. Some long-term alarms can also be an exception: for more info see the document [Monitoring. Operator's Guide](#), section [Appendix 1. Data update periods summary](#)
9. Click **OK (8)**.

Configuration of communication between *Agent of Control* and *Server of Control* is now complete.

5.3.4 Configuring captions

To use and configure captions, for each camera on which you want to use captions you must create a **Captioner** object.

Attention!

If multiple captioners have been created for a single camera, *Agent of Control* uses the captioner with the lowest ID number.

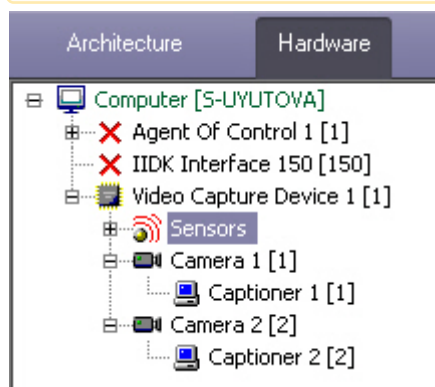

To configure the font and display area used for captions:

1. In the device tree, click the relevant **Captioner** object. On the right side of the **System settings** dialog box, the configuration panel of the **Captioner** object is displayed.

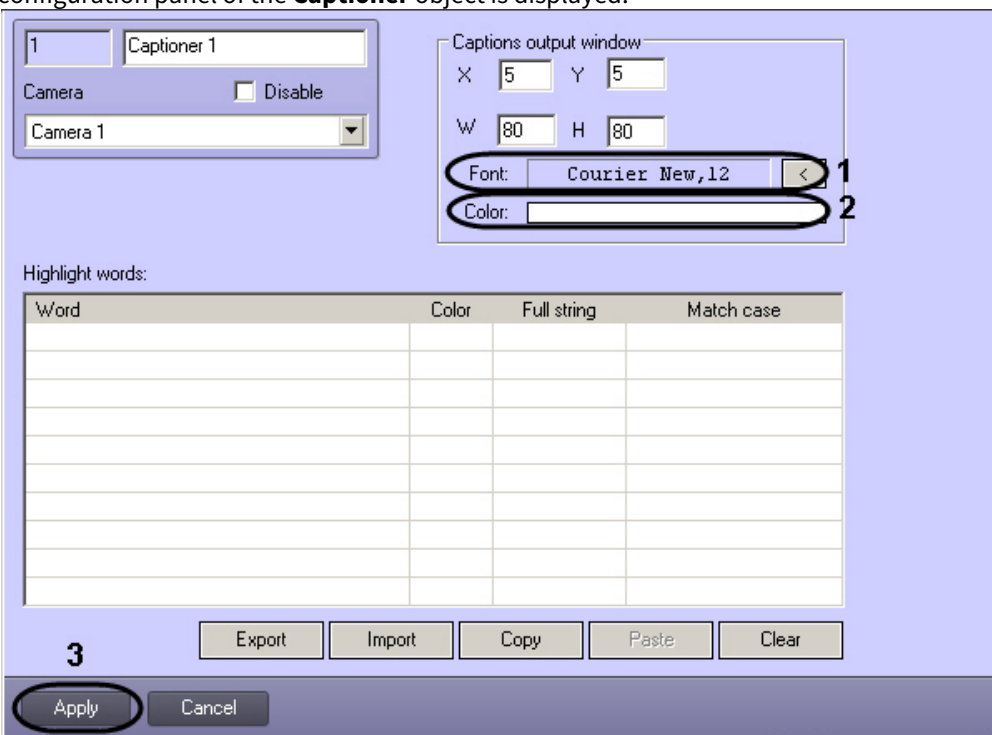

2. If you click the button to the right of **Font**, a dialog box appears in which you can configure the font face and size (1).

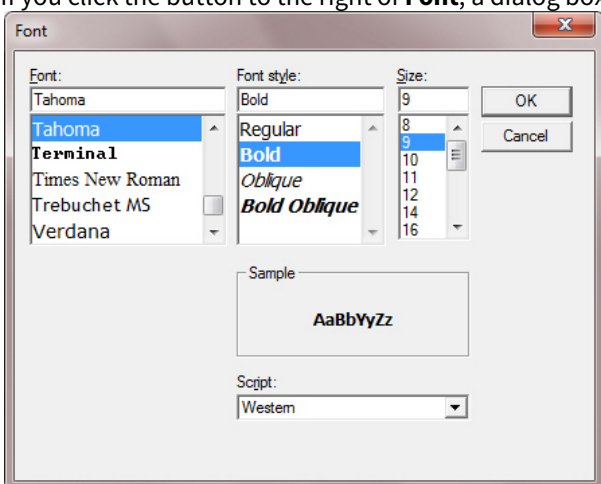

3. To configure the color of captions, double-click the area to the right of **Color**. A dialog box for configuring color appears (2).

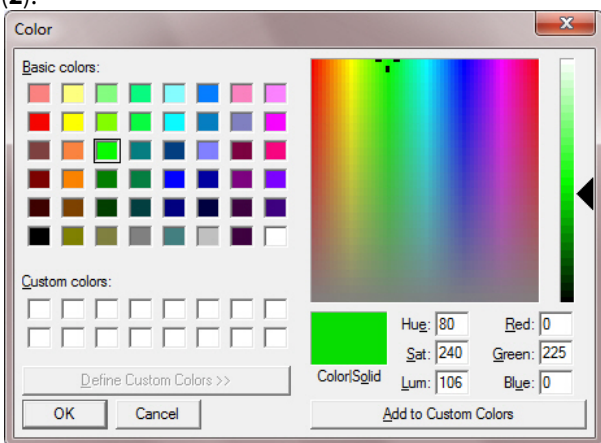

Configuration of the **Captioner** object is now complete.

5.3.5 Configuring the camera list

The list of cameras specified in the configuration panel for the **Partition Of Control** object defines the cameras whose archives can be accessed through the **Search in Archive** interface object (see the document [Monitoring Software Package: Operator's Guide](#)). In addition, this list defines the cameras whose state and archives are monitored by *Agent of Control*.

Depending on whether the list of cameras has been specified or not, the following situations are possible:

1. If cameras are specified in the list, *Agent of Control* works in normal mode: it monitors the state of cameras and their archives. *Server of Control* receives information about the number of cameras, disks, disk volume, etc.
2. If no cameras are specified in the list, *Agent of Control* checks for the presence of a **Long-term Archive** object in the system and gets information about disks from this object. In this case, *Server of Control* will receive information only for the disks marked in the **Long-term Archive** object. Access to the archive is not performed from the **Search in Archive** interface object during this process.
3. If no cameras are indicated in *Agent of Control* settings and there is no **Long-term Archive** object in the configuration, information about disks is taken from the **Computer** object; the disks indicated for storage of the main archive are taken into account. Access to the archive is not performed from the **Search in Archive** interface object during this process.

In the second and third cases, monitoring is performed of the state of the system (network functioning, restarts, etc.) and disks (their number and free space). The state of cameras and their archives is not available for monitoring.

Note.

Creation and configuration of the **Long-term Archive** object is described in the document [Intellect Software Package: Administrator's Guide](#).

To configure the list of cameras in use:



1. Go to the configuration panel for the **Partition Of Control** object.

The screenshot displays the configuration interface for a 'Partition Of Control' object. Key elements include:

- Object Identification:** ID: 386, TCP port (UPS): 8888.
- Agent Configuration:** Agent Of Control 1 (selected from a dropdown).
- Camera List:** A table with columns 'Number' and 'Keep archive for (days)'. A 'Cameras...' button is used to manage this list. Below the table, it indicates 'Total cameras: 0'.
- Sensor Configuration:** A section for adding sensors with columns 'Sensor ID' and 'Sensor type'. It includes 'Add...', 'Edit...', and 'Delete' buttons. Below this, it shows 'Sensors: 0' and a checkbox for 'Temperature sensor set'.
- Navigation:** 'Apply' and 'Cancel' buttons at the bottom.

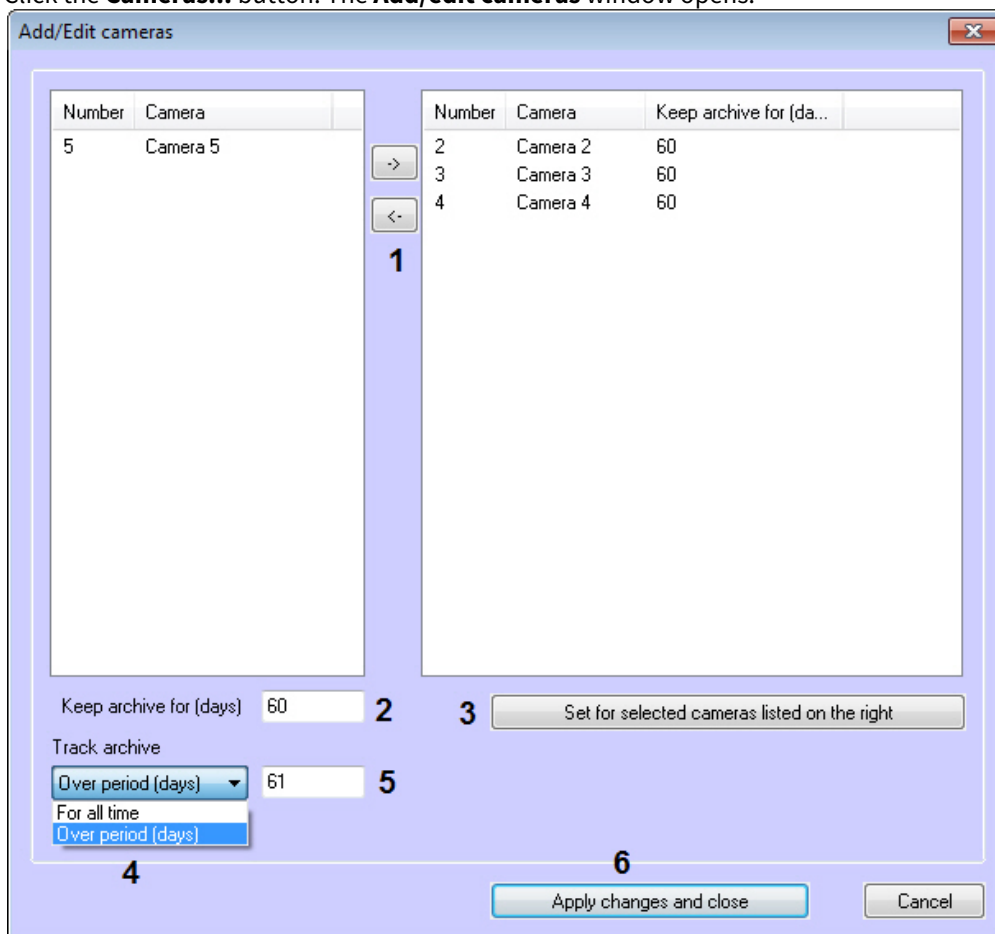
- Click the **Cameras...** button. The **Add/edit cameras** window opens.



- Configure the necessary cameras by clicking the  and  buttons to move cameras from the left list to the one on the right (1).
- Select cameras in the list on the right.
- Specify the time for video archive storage, in days (2).
- Click the **Set for cameras selected in the right list** button (3).
- Repeat steps 4 to 6 for all necessary cameras.
- Set the archive tracking time period (4): **For all time** or **Over period (days)**. When **Over period (days)** is selected, the (5) field is enabled to specify the number of days.

Note.

If **For all time** is selected, the algorithm of decision-making on an alarm for all time is used, even when the video archive is empty.

If **Over period (days)** is selected, the value entered in field (5) must be greater than or equal to the archive storage time + 1 day.

To take into account the regular voids in the archive, the number of days in the tracking period should be increased by the maximum number of days of regular voids during the archive storage.

- Click the **Apply changes and close** button (6). The selected cameras will be added to the list on the configuration panel of the **Partition of Control** object.
- Click the **Apply** button.

Note.

The ID numbers of cameras and captioners must be whole numbers.

Configuration of the camera list is now complete.

5.3.6 Configuring sensors

The system supports use of four fixed sensors (vibration sensor, lock sensor, temperature sensor, and additional sensor) as well as 12 expansion sensors. There is also a separate additional device, "temperature array".

Note. Before configuring a list of sensors for a protected site, you must create and configure the necessary **Sensor** objects in *Intellect* first. Creation and configuration of these objects is described in the document [Installing and configuring security system components guide](#).

Attention! Sensor IDs must be whole numbers.

Attention! If video data (i.e. clips or snapshots) are attached to the alarms, it is necessary to create a script for stopping recording on camera (see [Sample script for stopping camera recording](#)).

To configure the list of sensors in use:

1. Go to the configuration panel for the **Partition Of Control** object.

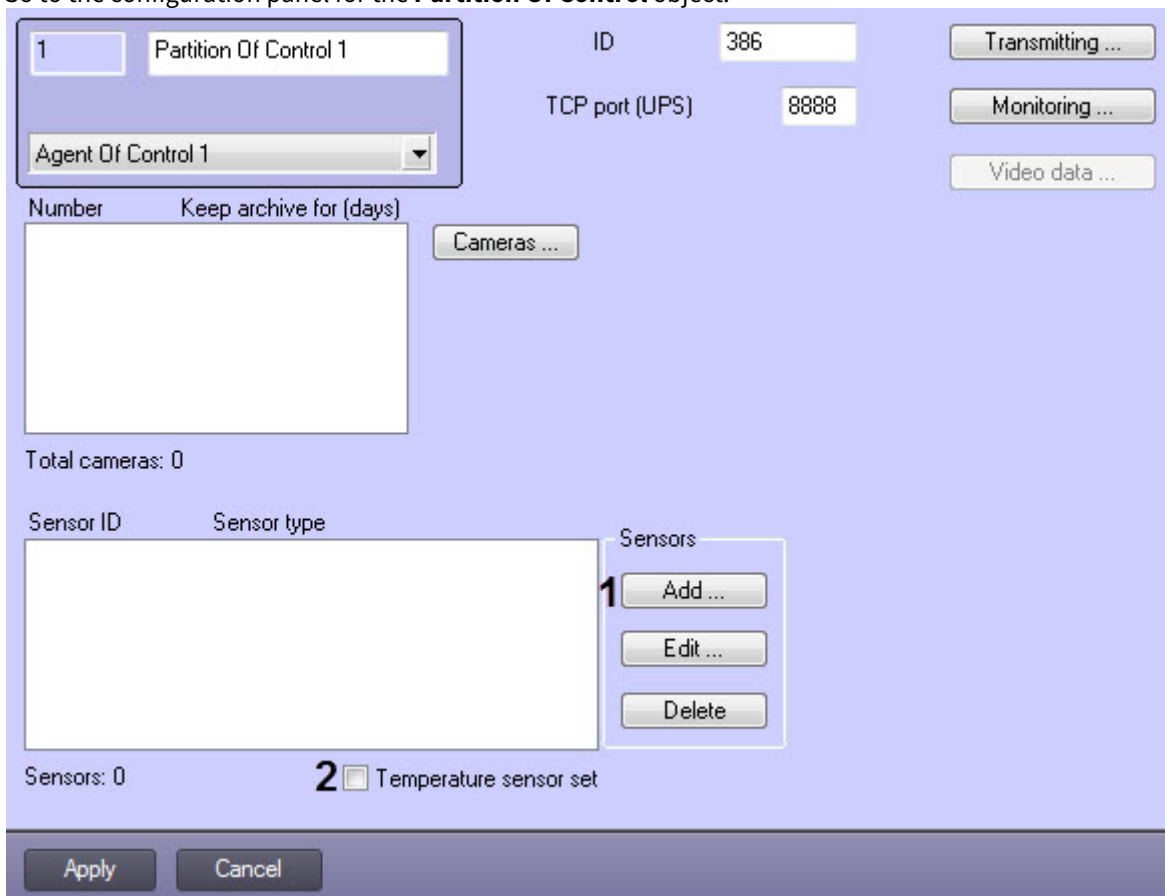

2. Click the **Add** button (1). A dialog box for adding a sensor appears.

3. In the **Type** drop-down list, select the type of sensor from the sixteen types described previously (1).
4. In the **Name** field, enter the text that will be sent to *Server of Control* together with the alarm message. This text will be overlaid on the video during the captioning process (2).
5. In the **ID** drop-down list, select a **Sensor** object that has been previously created in the Intellect device tree (3).
6. In the **Assignment to camera** drop-down list, select a **Camera** object that has been previously created in the Intellect device tree (4).
7. To enable sending video frames to *Server of Control* when a sensor is activated, select the **Transmit snapshots** check box (5). In the **Assignment to camera** field, specify the camera from which you want video frames to be sent (4).

Note.

The settings for sending video frames and for sending video fragments are different.

8. If you want for a video fragment to be sent to *Server of Control* when a sensor is triggered, select the **Transmit video** check box (6). In the **Assignment to camera** field, specify the camera from which you want video frames to be sent (4).
9. In the **Post-alarm time (sec.)** field, enter the time delay between when a sensor is triggered and the time of access to the video archives, in seconds (7). The default value is 20 seconds. This parameter is necessary for guaranteed recording on camera.
10. In the **Pre-alarm time (sec.)** field, specify the amount of time for which you want to pre-record before sensor triggering, in seconds (8). This allows obtaining video frames depicting not only the very moment at which an alarm occurs, but a short time before.
11. In the **Number of frames** drop-down list, select the quantity of video frames to be transferred when a sensor is triggered (for **video frame transmission** mode) (9).
12. In the **Interval (sec.)** field, enter the length of time, in seconds, between video frames if more than one frame is to be sent (10). Thus when an alarm occurs, it is possible to send to *Server of Control* an entire sequence of frames that represent different points in time, which increases the chance of viewing the most valuable frames (for **video frame transmission** mode).

Attention!
 For snapshots transmitting more, as well as for video clips transmitting, it is necessary to create a script for stopping video recording on camera (see [Sample script for stopping camera recording](#)).

Attention!
 When specifying the **Pre-alarm time**, **Number of frames**, and **Interval** settings, keep an eye on the configuration of the camera from which video frames are to be sent, and particularly on the **Pre-Alarm record** setting. **Pre-Alarm record** time on camera have to be greater or equal to **Pre-Alarm time** value in sensor settings.



13. In the **Length (sec.)** field (1), specify the length of the video fragment to send (for **video fragment transmission** mode).

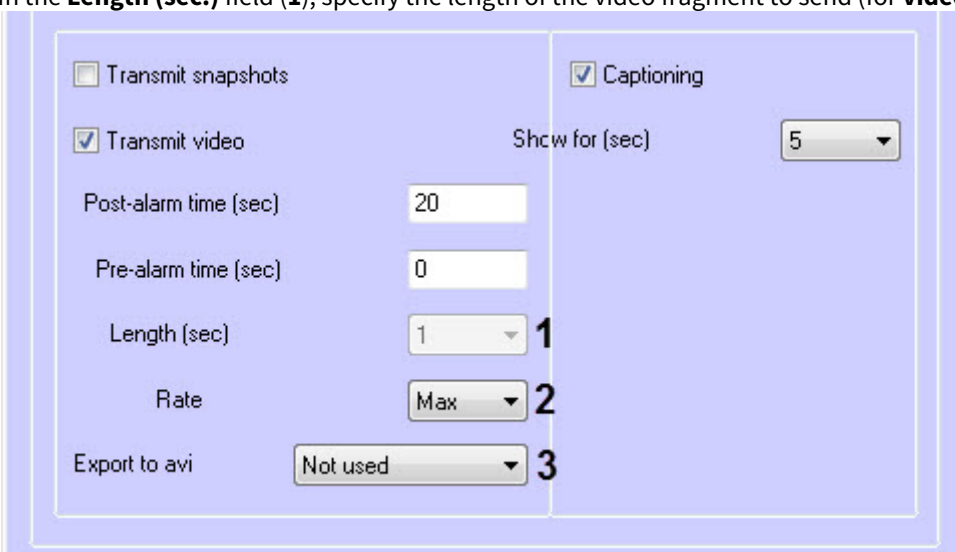

Attention!

This setting is unavailable in the current version. The length will be determined by the size of the video fragment file in the video archive. To limit the length of the video fragment to be sent, use a script to stop recording on the camera (a sample script is found in the [Sample script for stopping camera recording](#)).

14. In the **Rate** field, enter the transmission rate for the video fragment (for **video fragment transmission** mode) (2).
15. To overlay captions on video when a sensor is triggered, select the **Captioning** check box (11). In the **Assignment to camera** field, specify the camera on whose video you want to overlay captions (4).
16. In the **Show for (sec.)** drop-down list, select the amount of time for which you want captions to be displayed on video, in seconds (12).
17. Click **OK** (13).
18. To perform monitoring to ensure that temperatures do not deviate from an allowed range, select the **Temperature sensor set** check box (3). A set of DS18S20-type temperature sensors is used for temperature monitoring. Temperature sensors are connected via a two-wire MicroLAN to a MicroLAN network adapter, which in turn connects to the COM port of the computer on which *Agent of Control* is installed. The MicroLAN network adapter can be connected to the USB port of the computer on which *Agent of Control* is installed, by adding a RS232–USB adapter.

Configuration of the list of used sensors is now complete.

5.3.7 Configuring alarm groups

For the **Access Control** and **Detection Tools** alarm groups, by default no data is sent from *Agent of Control*. These alarm groups, as well as **Hardware** and **Fire/Security System**, can be used for designating their respective alarm types.

To classify events of an object as belonging to a particular alarm group, create an object (if it does not exist already) in the device tree. For example, if you want for the signal from the **Abandoned Object Detection Tool** to be displayed in Monitoring in the **Detection Tools** alarm group, create a **Detector Zone** object and configure it (select the **Abandoned Object Detection Tool** type, specify the detection area and sensitivity, etc.; for more details, see the document [Intellect Software Package: Administrator's Guide](#).

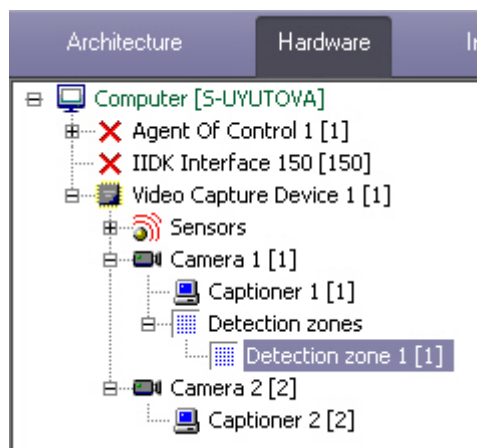

To associate various events with particular alarm groups:

1. Go to the configuration panel for the **Partition Of Control** object.

2. Click the **Monitoring...** button. The **Add/Edit events for Monitoring** window opens.

id	Type	Type (id)	Number	Name	Event	Event (id)	Group of alarms	Conf.	Video data	Message	Detail
2	Detection zone	CAM_ZONE	1	Detection zone 1	Alarm in the zone	MO_START	Detections	No	No	Abandoned object	
3	Camera	CAM	1	Camera 1	Disarmed	DISARM	Detections	No	No	Camera (cid:) disarm...	

3. To add an event, click the **Add...** button. The event configuration window opens.

4. In the form that appears, in the **Type** drop-down list, select the type of device (**1**). This list contains the types of all objects created on the **Hardware** tab of the **System settings** window that have recorded events.
Example: In the case of the Abandoned Object Detection Tool, select the **Detector Zone** type.
5. Select an ID number for the object of the selected type from which you want to get events (**2**). If you want to get events from all devices of this type, leave this field blank.

6. In the **Event** drop-down list, select an event type (3). The available event types depend on the selected object type. System type of the event in brackets is for use in scripts and programs (see [Programming Guide](#) and [Programming Guide \(JScript\)](#)).
Example. For the Abandoned Object Detection Tool triggering event, select **Alarm in the zone (MD_START)**.
7. In the **Group of alarms** drop-down list, select an alarm group and indicate in which alarm group you want for *Monitoring* to display alarms for this event (4).
8. It is possible to get confirmation of alarm acceptance from the *Server of Control*. Select the type of confirmation in the **Confirmation** dropdown list (5):
 - a. **No** – no confirmation is sent.
 - b. **Simple** – *Agent of Control* sends confirmation when an alarm is confirmed by the operator.
 - a. **Complex** – when accepting an alarm the operator must confirm it in the confirm box and after that the confirmation is sent.

Note.

The *Agent of Control* sends the "Confirmed: Monitoring event" message to *Intellect* core when there is the confirmation of alarm acceptance on the *Server of Control*. Scripts that use this event can be created in *Intellect* – see [Sample scripts for processing alarm confirmations](#).

Note.

Confirmation sending can be disabled on the side of the *Server of Control* – see [Sending confirmations of alarm acceptance](#).

9. In the **Video data** dropdown list select the video data configuration that is to be transmitted (6). Information on how to set video data transmission configurations is given in the [Adding video data to alarms](#) section.
10. Enter text in the **Message** field (7). The text entered in this field will appear in the **Device** column of the **Alarm Reaction** dialog form (see the document [Monitoring Software Package: Operator's Guide](#)).
If the object identifier (2) is not specified, the following variables can be used in the **Message** field to detail the message:
 - a. <id> – identifier of the object from which the event came.
 - b. <name> – the object name.

Attention!

<id> and <name> are to be in lower case.

After substitution of variables values the message must not be longer than 40 characters. If the resulting message is longer, extra characters will be dropped.

Example.

When the **Disarmed** event appears at the **Camera 1**, the “Camera [1] disarmed” message is sent.

11. To search for additional information in messages from a device of this type (for the substring "param0<>"), select the **Capture detailed data** check box (8).
12. Click **OK** to save changes (9).

This means that when integrating a new device into *Intellect*, if a developer wants to be able to send more detailed information to *Monitoring*, when generating an event from the device, the developer should add detail in the param0<> parameter. For example, if there is a Motherboard Control module that has the Alarm event, the following values could be included in param0<>: "processor cooler", "BIOS battery", etc. If you enter "Motherboard" in the **Message** field and select **Capture detailed data**, the following text may appear in the **Device** column of the **Alarm Reaction** dialog form: "Motherboard (CPU cooler)".

Example of how to configure the message for the Abandoned Object Detection Tool.

In the example shown with the Abandoned Object Detection Tool, when the detection tool is triggered a indicator corresponding to the **Detection Tools** alarm group becomes red in the Control Panel.



Click this indicator to view the **Alarm Reaction** window, which indicates that the Abandoned Object Detection Tool has been triggered.

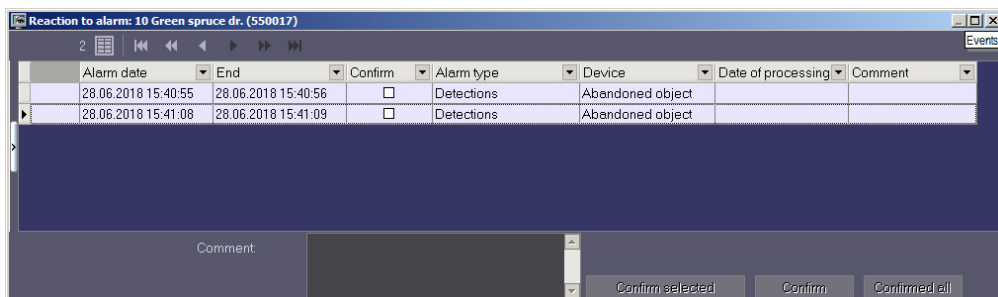

Similarly, it is possible to monitor messages from other objects created in the *Intellect* device tree, on the **Hardware** tab. Configuration for associating different events with certain alarm groups is now complete.

5.3.8 Adding video data to alarms

If the transmission of user alarms (see [Configuring alarm groups](#) section) to the *Server of Control* is configured, then video data can be added to these alarms. The video data transmission configurations can be created in *Monitoring* software in order to be added to any events when configuring alarm groups.

⚠ Important!

If video data (snapshots or videos) is added to an alarm, then the script for stopping camera recording is to be created (see [Sample script for stopping camera recording](#) section).

Configure adding video data to alarms as follows:

1. Go to the settings panel of the **Partition of Control** object.

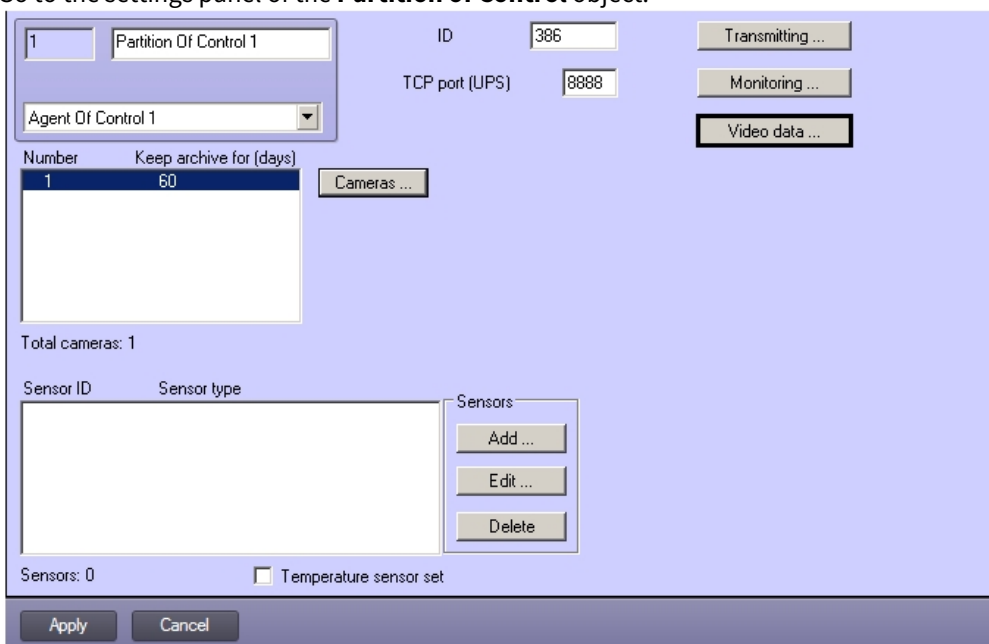

- Click the **Video data...** button. The **Adding/Removing configurations for transferred video data** box appears.

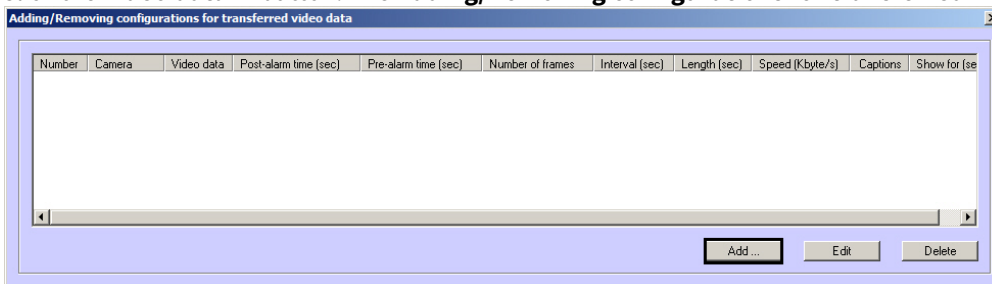

- To add a new video data transmission configuration click the **Add...** button. The configuration settings box appears.

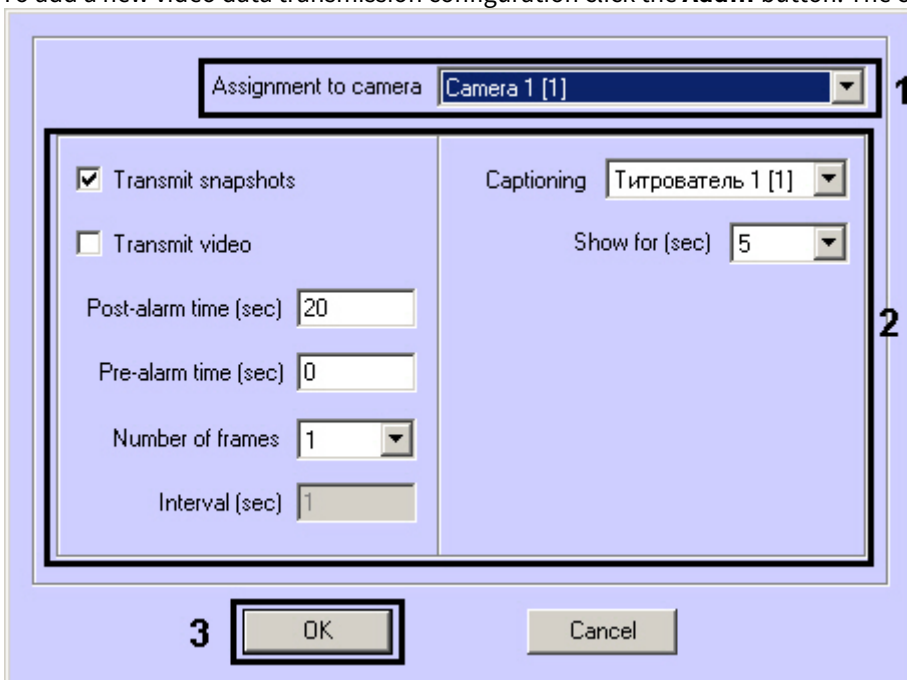

- In the **Assignment to camera** dropdown list select the **Camera** object that will be used for getting video data (1).
- Configure the data transmission parameters (2). The data transmission parameters are the same as those for video data transmitted along with sensor alarms (see [Configuring sensors](#) section, steps 7-17).
- Click the **OK** button (3). The created configuration is added to the list.
- Repeat steps 3-6 for all video data transmission configurations.
- Click the **OK** button.
- Click the **Apply** button.

Video data transmission configurations are now created.

5.4 Connecting to uninterrupted power supplies

If your computer has a Smart-UPS uninterrupted power supply unit made by APS, messages from the UPS can be sent to *Server of Control*.

Configuration of a UPS is performed in the following order:

- Install the StateUPS utility.
- Configure the PowerChute plus utility.

5.4.1 Configuring StateUPS

StateUPS utility (exe-file and ini-file) is installed with *Agent of Control* and placed to the <Intellect software installation>/Vhost/UPS/.

Note

Files from the <Intellect software installation>/Vhost/UPS/Ext directory will look for the ini settings file in the same directory as the StateUPS utility.

Configure the file StateUPS.ini in this directory:

1. Address – address of the machine on which *Agent of Control* is running. The default value of this parameter is 127.0.0.1. If you install StateUPS on the same computer on which *Agent of Control* is installed, it is not necessary to change this parameter.
2. Port – TCP port to which StateUPS sends messages from the UPS. The value of this parameter must match the corresponding setting of *Agent of Control*, TCP port (UPS) (see the section [Configuring a port for incoming UPS messages](#)).

If the StateUPS utility is to be used on another computer, do the following:

1. Create "HKLM\SOFTWARE\BitSoft\VHOST\VHostService" section in the registry for 32-bit OS ("HKLM\SOFTWARE\Wow6432Node\BitSoft\VHOST\VHostService" for 64-bit) on this computer.
2. In this section, create the "FolderLog" parameter. In the "FolderLog" parameter specify the path where the UPS folder will be created containing ini-file. For example, if the folder is C:\EVUPS, then "FolderLog" = "C:\EVUPS\"
3. In the specified folder, for example, C:\EVUPS, create the UPS sub-folder and copy the StateUPS.ini into it.

5.4.2 Installing the software from the UPS vendor

After the StateUPS is configured, install the software from the UPS vendor. Before starting installation, make sure that the interface cable is connected to the UPS.

1. To start the installation process, start the executable file pc521.exe in the installation folder UPS\PowerChutePlus. A window opens to inform of the start of installation.



2. On the following wizard page, select the option **Continue with the installation now** and click the **Next** button.

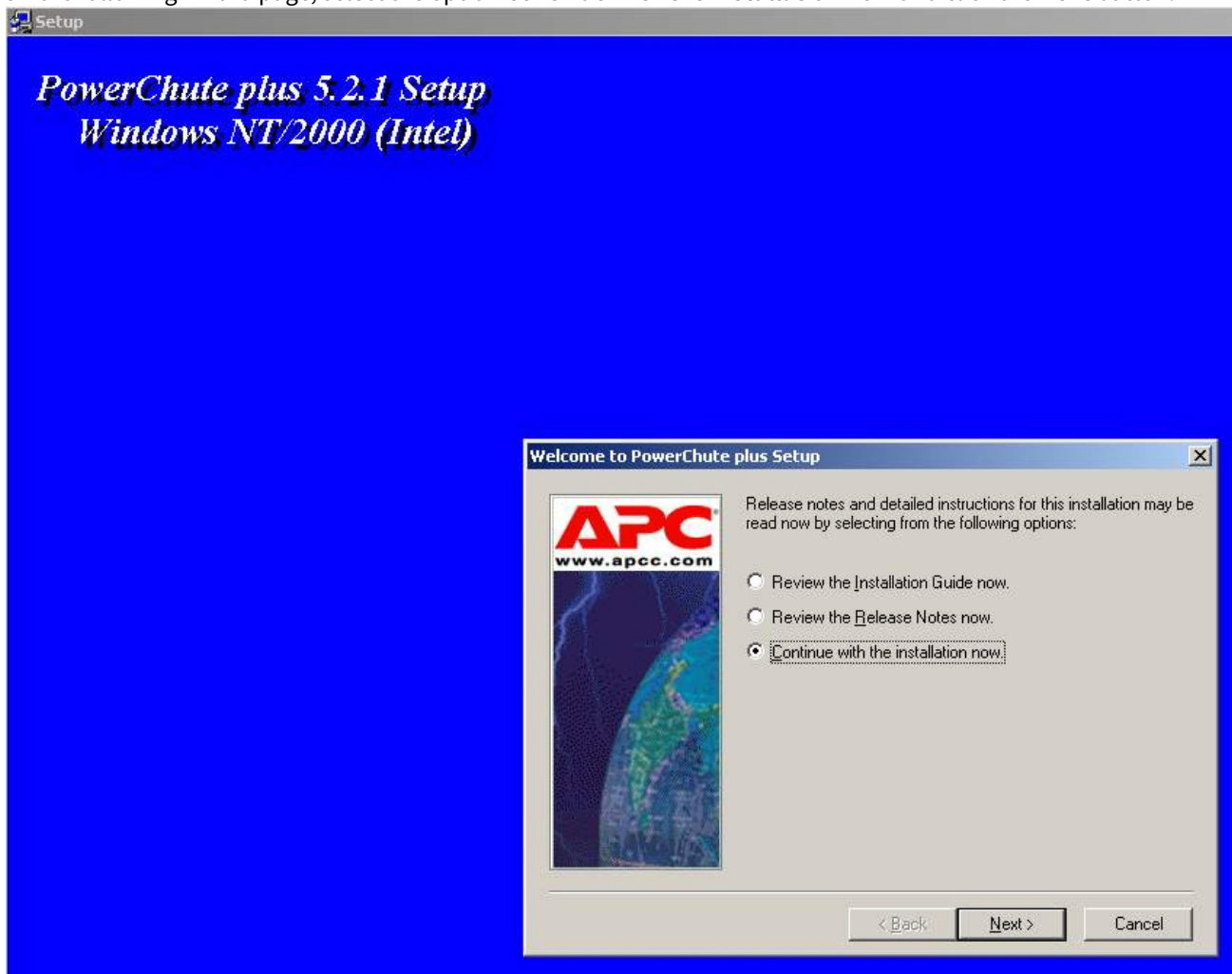

3. On the following wizard page, click the **Yes** button to accept the license agreement.

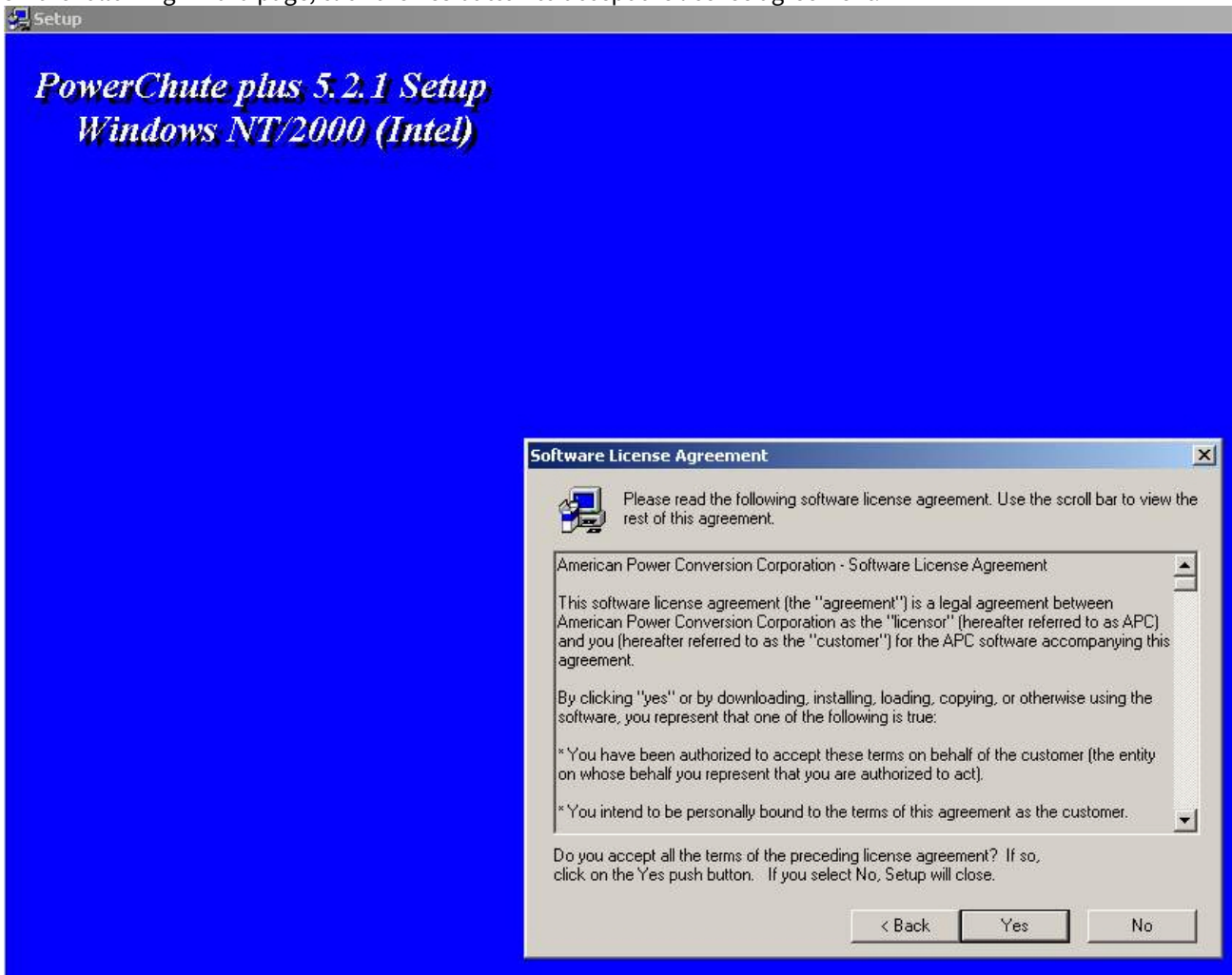

4. On the following wizard page, select the **Typical** installation type and indicate the path at which you want to install the software.

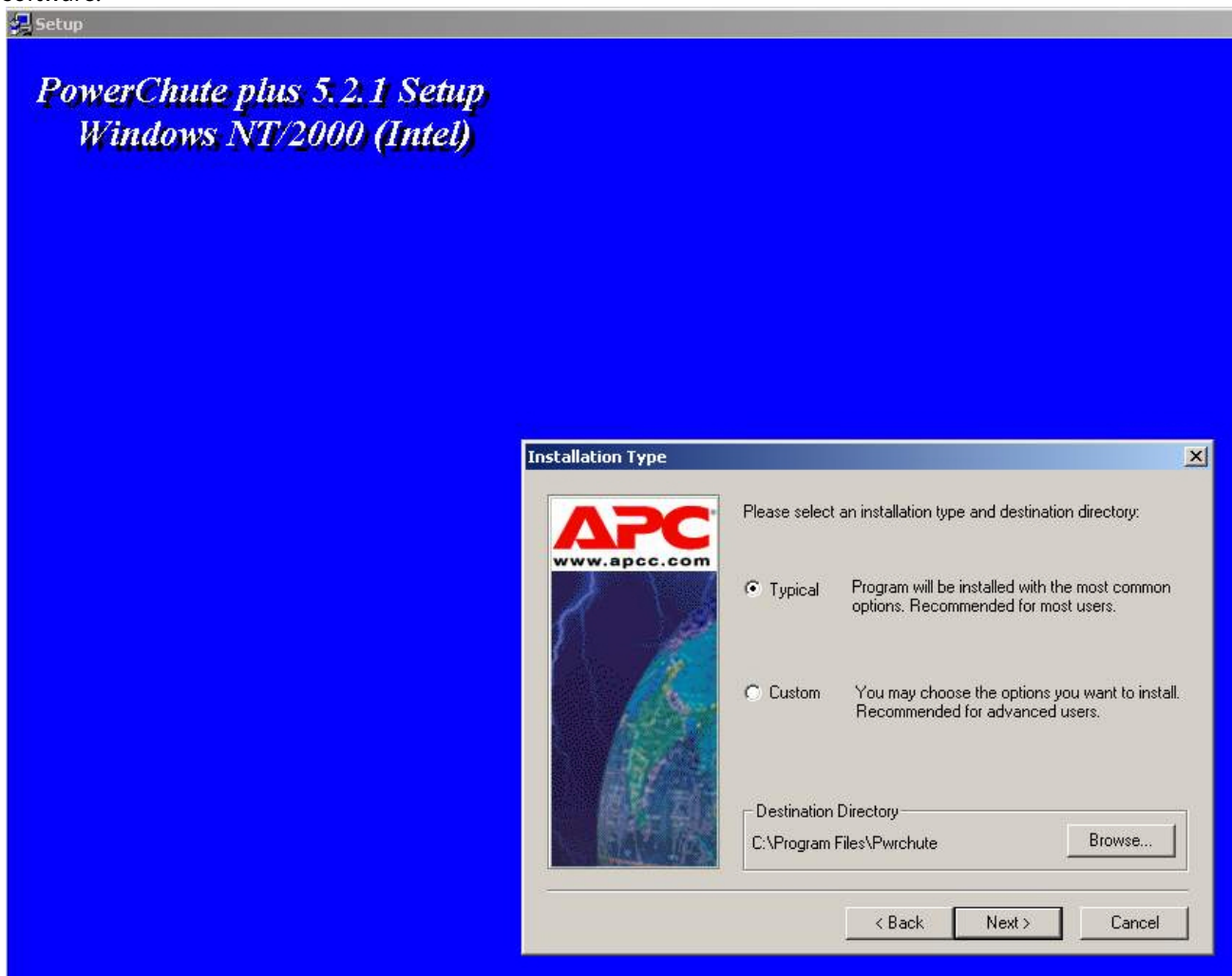

5. Copying begins of the necessary files.

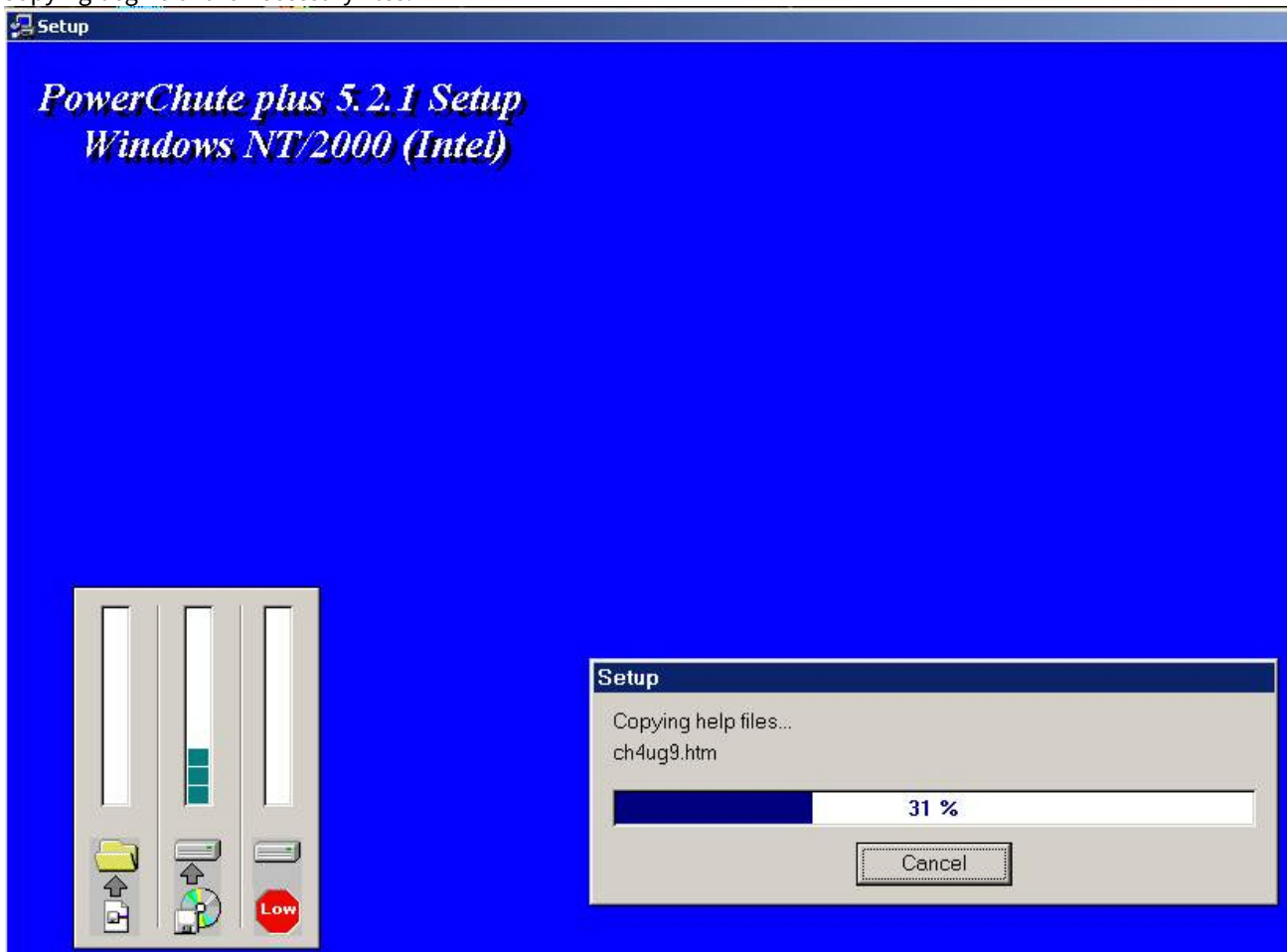

6. When copying is complete, a dialog box appears with a request to automatically determine the COM port on which the UPS is located. Click the **Yes** button.

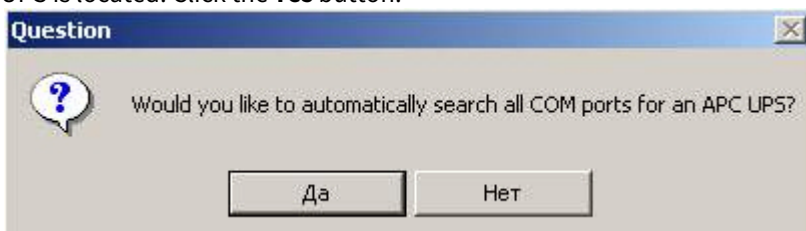

7. The search process begins.

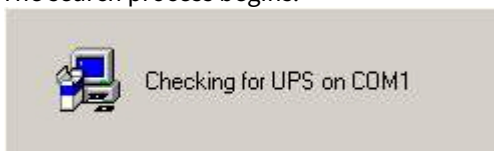

8. When the search is complete, the program will show what type of UPS it found and on which COM port. Click the **Next** button.

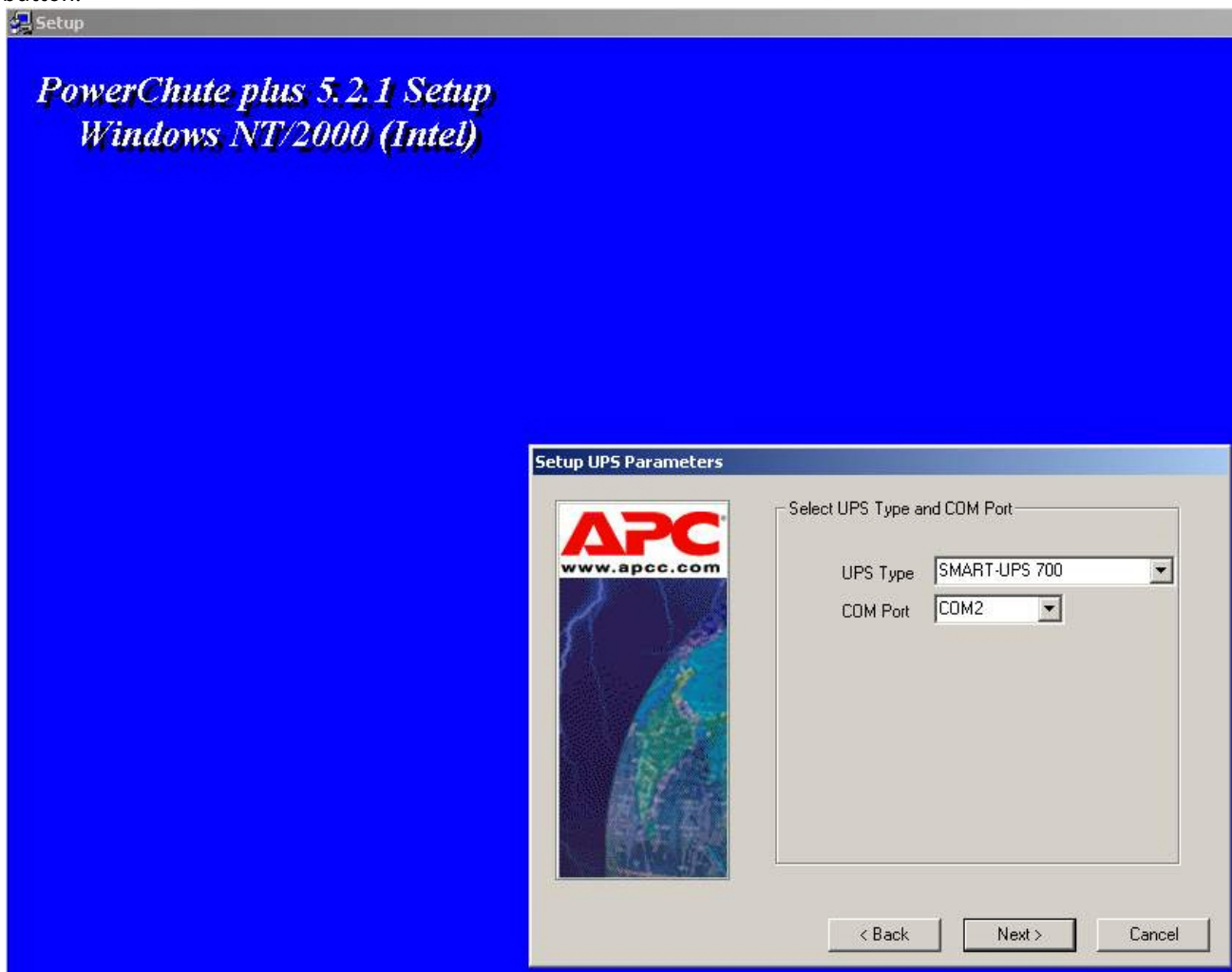

9. On the next wizard page, clear the **Enable PowerChuteplus remote monitoring** check box and click the **Next** button.

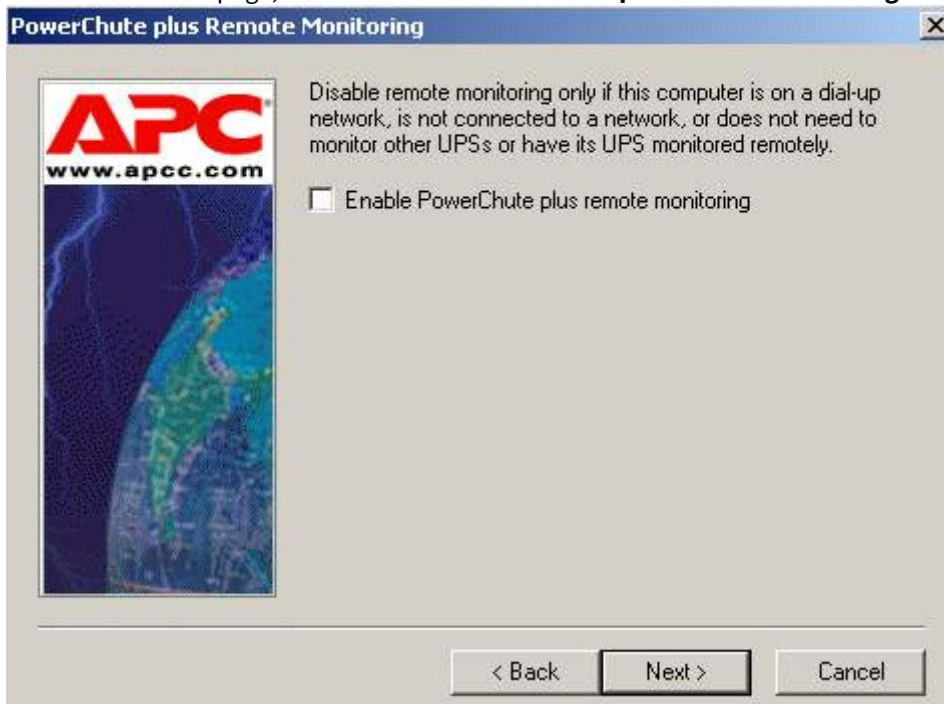

10. The two following wizard pages complete the installation process.

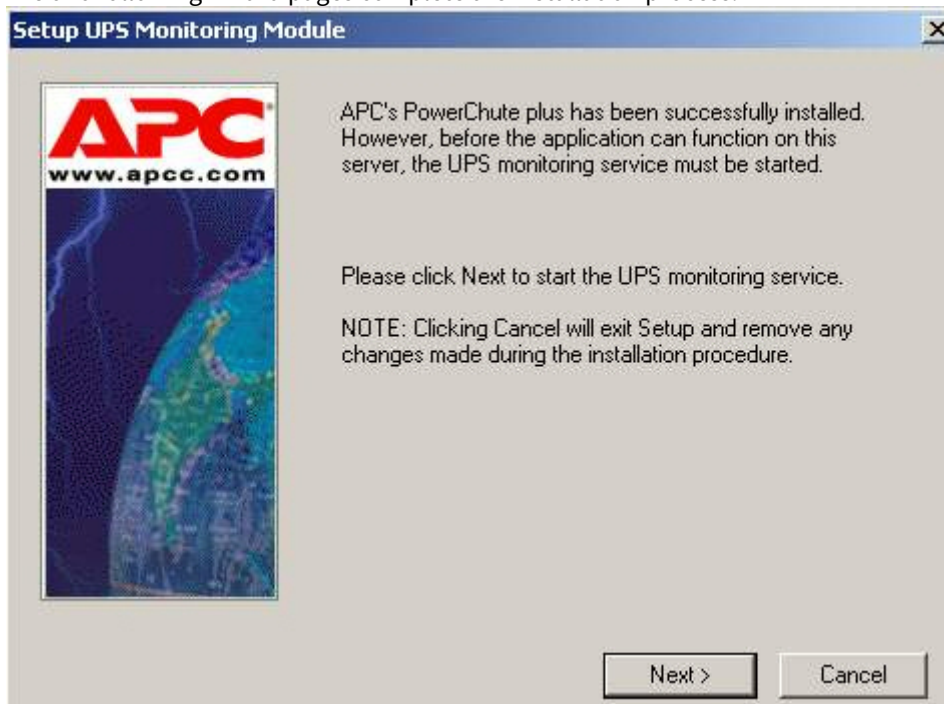

Dialog box to confirm installation completion.



Installation of the StateUPS utility is now complete.

5.4.3 Installing the PowerChute plus utility

Note.

The PowerChute utility configuring process is given in this document as an example. Alternative software can have different settings.

Alternative software must allow binding certain reactions with UPS events.

To set up the PowerChute plus utility:

1. Start the PowerChute plus configuration program, by selecting **Start -> Programs -> PowerChute plus -> PowerChute plus**.

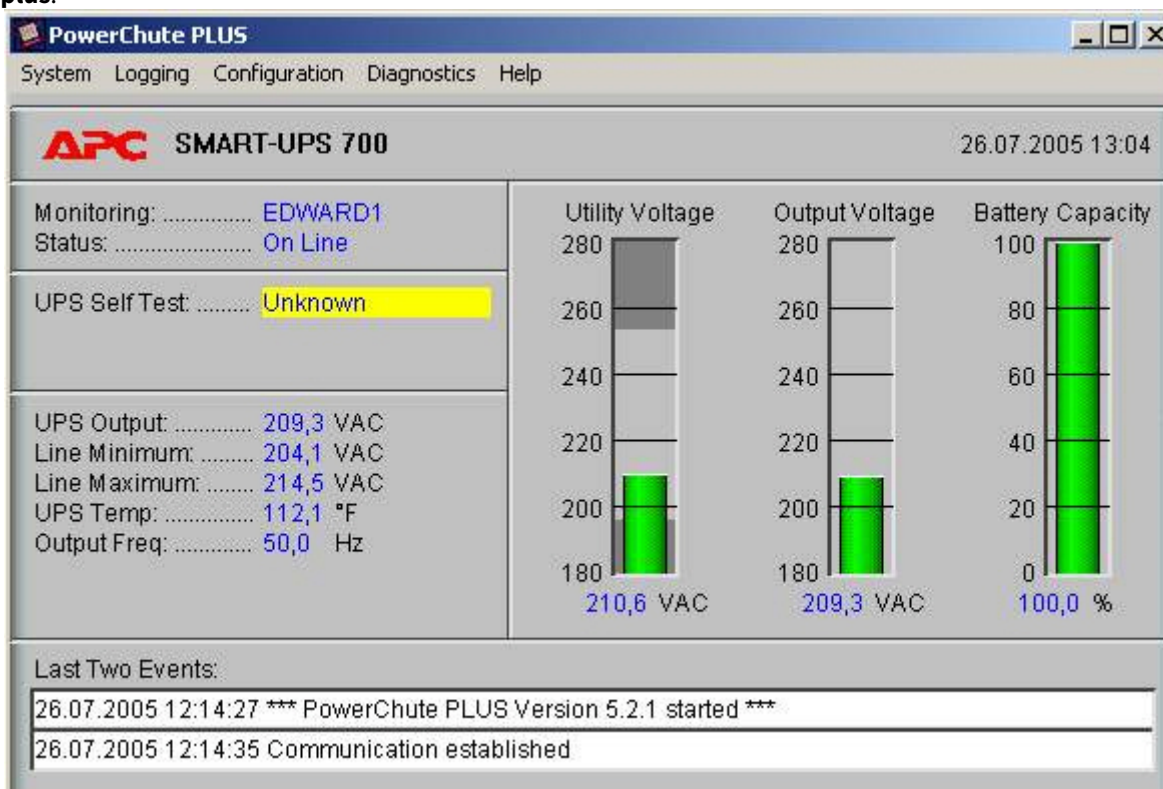

2. Select the menu item **Configuration -> Event Actions...** A dialog box appears, in the left part of which there is a list of events for which different reactions can be assigned (right part of the window). It is recommended to disable the **Notify Users** option for all events unless there is a need for it; otherwise, messages are sent to the entire domain on which the computer is located.

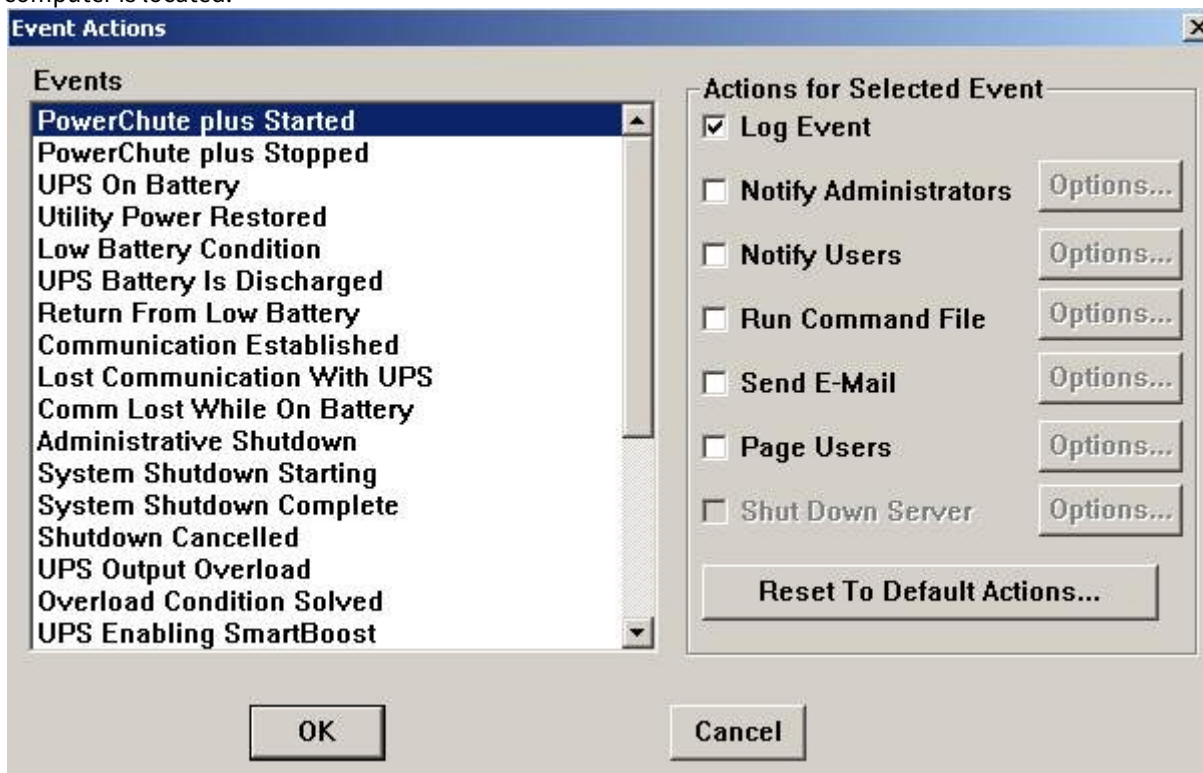

A more detailed list of events is given in the table.

ID Code	Event Name	Description
1000	PowerChute Started	PowerChute service started
1001	PowerChute Stopped	PowerChute service stopped
1002	Communication Established	Communication restored
1003	Utility Power Restored	Electricity restored
1004	UPS Self-Test Passed	Self-Test passed
1005	Administrative Shutdown	Administrative shutdown
1006	Shutdown Cancelled	Shutdown cancelled
1007	Returned From Low Battery	Battery charged
1009	UPS Battery Replaced	Battery replaced
1013	Overload Condition Solved	Overload is back to normal
1014	Runtime Calibration Started	Runtime Calibration Started
1015	Runtime Calibration Finished	Runtime Calibration Finished
1016	System Shutdown Starting	System is shutting down
1102	UPS Internal Temperature In Bounds	Internal temperature is in bounds
2000	UPS On Battery	Electricity turned off
2001	System Shutdown Complete	System performed shutdown
2002	UPS Enabling SmartBoost	Low-voltage mode
2003	Low Battery Condition	Battery is running low
2004	Runtime Calibration Aborted	Runtime Calibration Aborted
2007	UPS Enabling SmartTrim	High-voltage mode
3000	Lost Communication With UPS	Communication lost
3001	UPS Output Overload	Overload
3002	UPS Self-Test Failed	Self-Test failed
3003	UPS Battery Is Discharged	Battery discharged

3004	Comm Lost While On Battery	Comm Lost While On Battery
3016	Battery Needs Replacing	Must replace battery
3107	Maximum Internal Temperature Exceeded	High internal temperature

PowerChute plus can be configured so that any of the events listed previously can be sent to the *Server of Control*.

Events marked in green are highly recommended for sending to *Server of Control*.

The <*Intellect installation*>\Vhost\UPS\Ext\ folder also includes three executables that have been created for specific events:

- PowerOff.exe (electricity is off)
- PowerOn.exe (electricity is restored)
- BatDisch.exe (battery is discharged)

This minimal set can be used with different series of Back-UPS that do not support calling third-party subprograms from from the command line.

5.4.4 Example of configuration of event distribution

Let us consider the following situation: electricity has turned off and the UPS began to work in battery mode (ID Code = 2000), and after a time electrical supply was restored (ID Code = 1003).

In this case to configure events notifying do the following:

1. In the list of events, select the event **UPS On Battery** and, for this event, select the **Run Command File** check box.

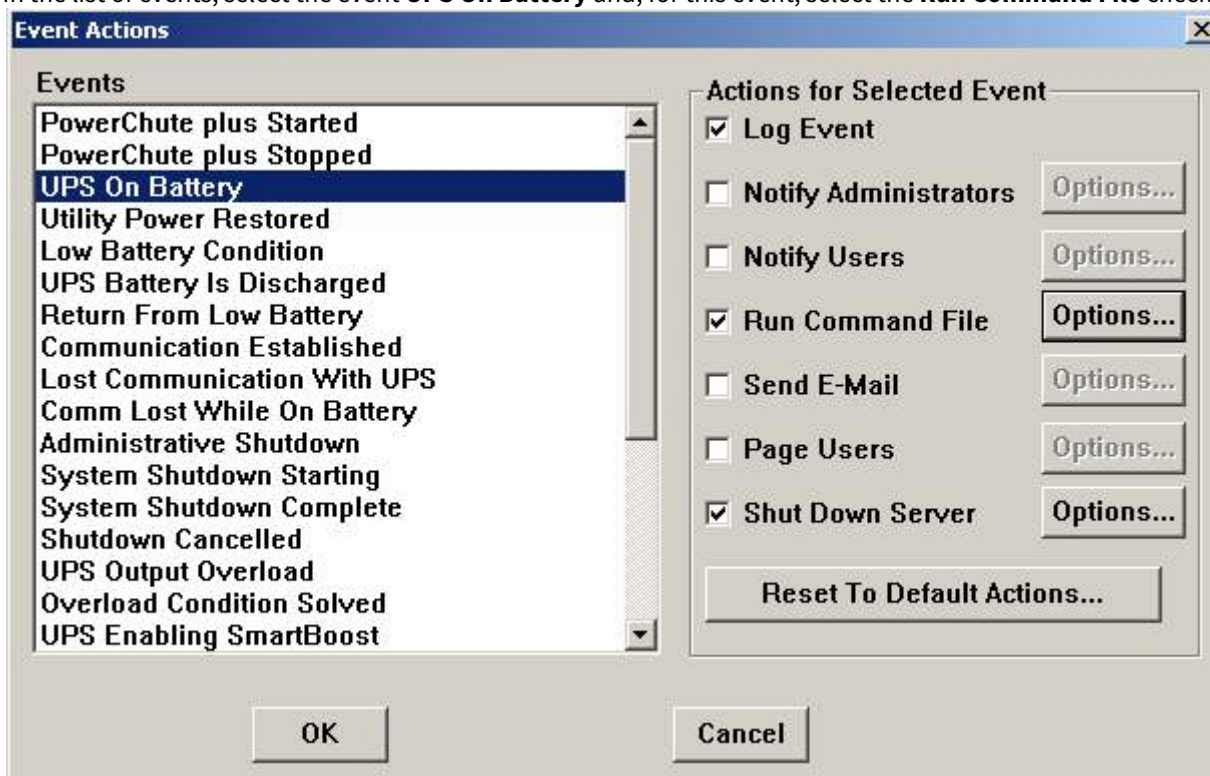

2. To the right of **Run Command File**, click the **Options...** button.
3. In the dialog box that opens, indicate the full path to the StateUPS utility that you want to be started when the event occurs.

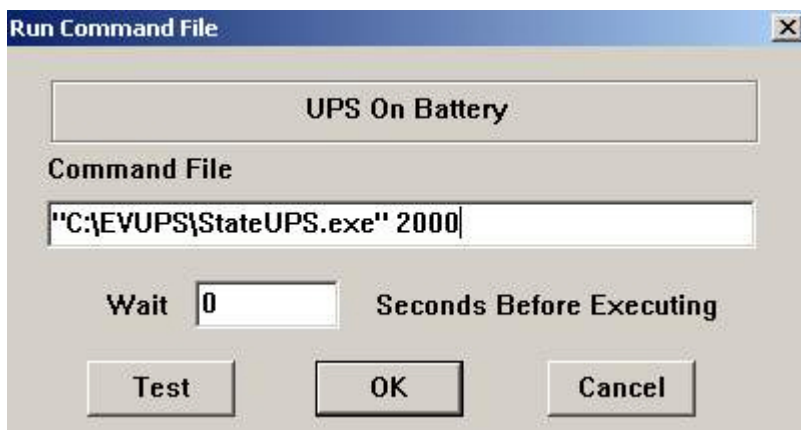

This path should be surrounded by double quotation marks (one at the beginning of the path and one at the end). Leave a space and then indicate the ID code; for the **UPS On Battery** event, the ID code is 2000.

4. Similar actions for the **Utility Power Restored** event are shown in the following figures.

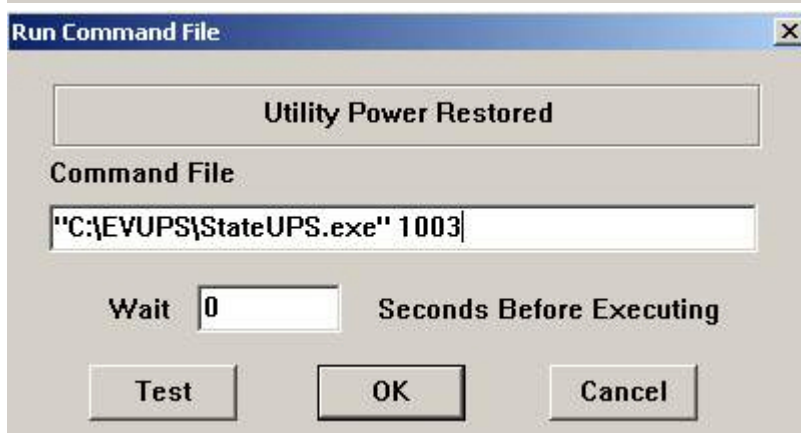
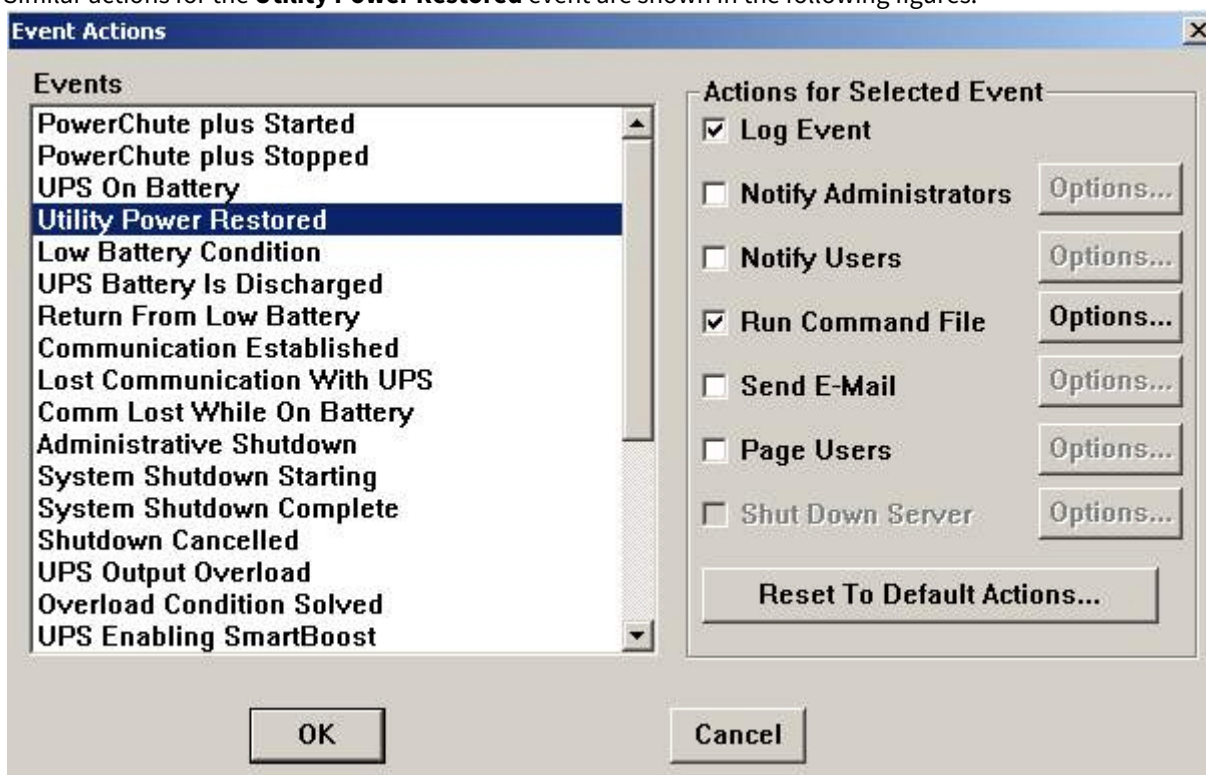

You should also remember that after utility power is restored, the UPS does not always generate the **Utility Power Restored** event; sometimes, it generates the **UPS Enabling SmartBoost** or **UPS Enabling SmartTrim** events. In order to not "miss" the

moment at which utility power is restored, it is advisable to also handle the **UPS Enabling SmartBoost** and **UPS Enabling SmartTrim** events.

Each time the StateUPS utility is called, a log file is created in the <Intellect installation>\Vhost\UPS folder with a name of the following format:

```
upslog_<state><date><time>.log
```

5.5 Working with Agent of Control without Windows administration rights

To allow the user not added to the Administrators group in the Windows operating system to work correctly with *Agent of Control*, make sure the following conditions are fulfilled:

1. The user must have full access to the *Agent of Control* registry section:
HKEY_LOCAL_MACHINE\Software\BitSoft for 32-bit system
(HKEY_LOCAL_MACHINE\Software\Wow6432Node\BitSoft for 64-bit).
2. The user must have full rights for the folder <DISK>:\Backup, where <DISK> is the logical disc where Intellect software is installed.

6 Configuring Server of Control

To configure *Server of Control*, go to the **System settings** window. Use of this window is described in [Intellect Software Package: Administrator's Guide](#).

6.1 Creating necessary Server of Control objects

Note.

Server of Control, as well as *Agent of Control*, can operate in [distributed architecture of the digital video surveillance system](#). In this case both *Server of Control* and *Agent of Control* shall be configured locally, not remotely. *Agents of Control* can view each other in the distributed configuration but cannot change each other's settings. *Agents of Control* cannot view *Servers of Control* while *Servers of Control* can view where *Agents of Control* are installed.

Create objects of the *Server of Control* in the hardware tree as follows:

1. Go to **Hardware** tab in the **System settings** dialog box (1).

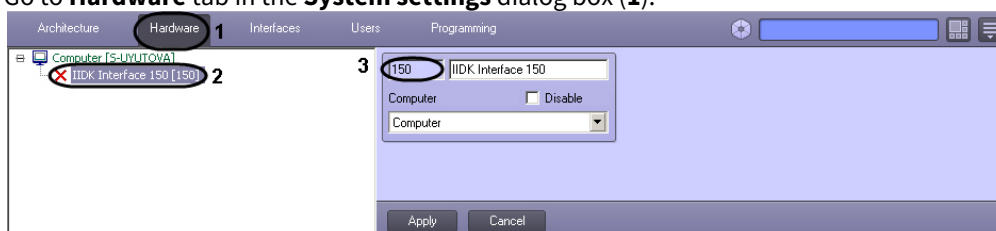

2. Create an **IIDK interface** object under the **Computer** object (2). Set the **IIDK interface** object number (3).
3. Create a **Server of Control** object under the **Computer** object.

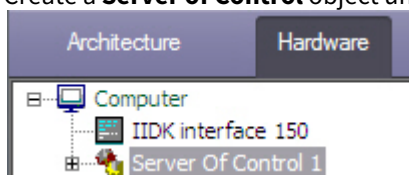

4. When the **Server of Control** object is created its settings panel is displayed on the right of the **System settings** dialog box.

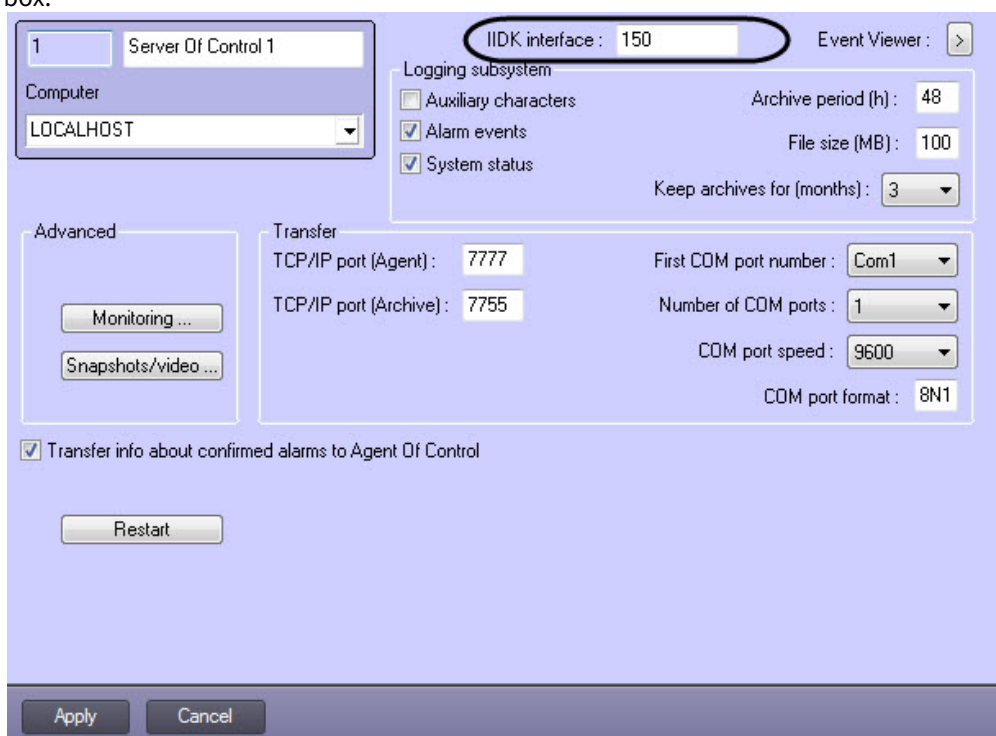

- Specify the **IDK interface** object number in the **IDK interface** field.
- Create one or more **Partition of Control** objects the **Server of Control** object. When you create these objects specify the same ID as in the **ID** field on the settings panel of the corresponding **Partition of Control** object created under the **Agent of Control** object.



Note
 The **ID** and **Name** fields must not contain underscores (_) or backslashes (\), the **ID** field is limited to 9 characters and must not contain spaces.
 The object address can be specified as the name.

The required objects are now created in the hardware tree.

6.2 Configuring a connection

A *Server of Control* can simultaneously interface with objects over both the TCP/IP and RS232 protocols.

To configure a connection between *Server of Control* and *Agent of Control/Archive*:

- Go to the configuration panel for the **Server of Control** object.

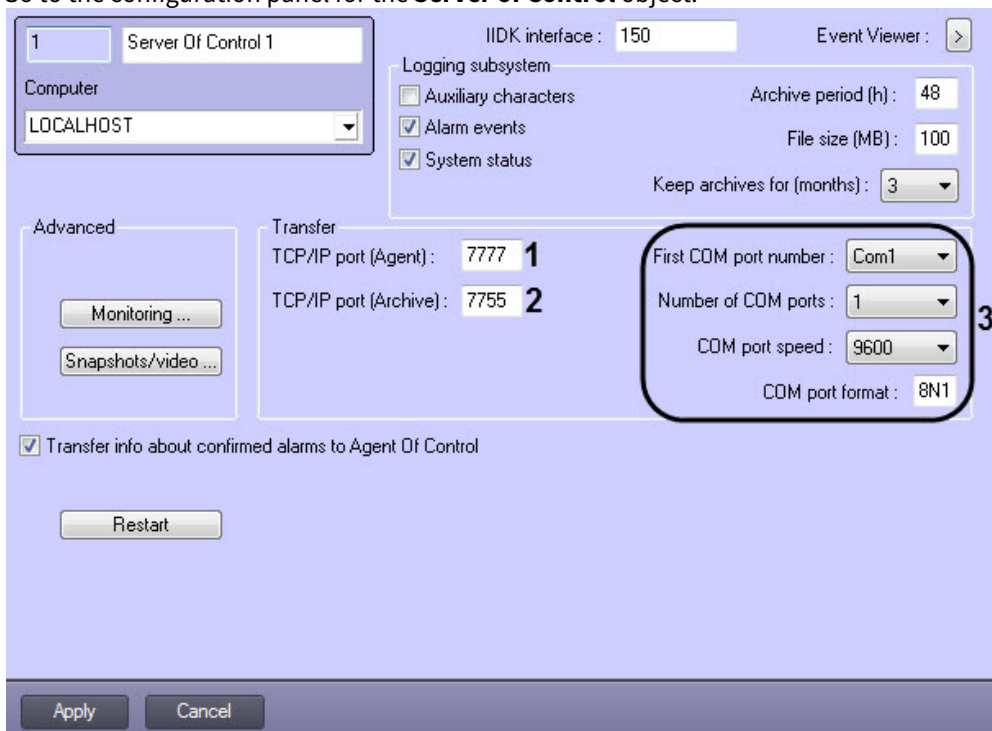

- In the **TCP/IP port (Agent)** field, enter the port number for TCP/IP communication with remote objects (1).
- In the **TCP/IP port (Archive)** field, enter the port number for TCP/IP communication with the **Search in archive** module (2).
- For the RS232 protocol, indicate the following parameters: **First COM port number**, **Number of COM ports**, **COM port speed**, and **COM port format** (3).
- Click the **Apply** button.

Connection configuration is complete.

6.3 Configuring the logging subsystem

The logging subsystem allows configuring the detail level at which *Server of Control* activities are logged.

The main log file is located in the <Intellect software installation folder>\VHost folder, in the file vsrvYYMMDD.log, where YY is the year, MM the month, and DD the day.

To configure the logging subsystem:

1. Go to the configuration panel for the **Server of Control** object.

The screenshot shows the configuration panel for the logging subsystem. The 'Logging subsystem' section is highlighted with a red box and numbered 1 through 6. The 'Transfer' section is also highlighted with a red box. The 'Advanced' section contains buttons for 'Monitoring ...' and 'Snapshots/video ...'. The 'Restart' button is located at the bottom left. The 'Apply' and 'Cancel' buttons are at the bottom center.

2. To log auxiliary characters at the transport level, select the **Auxiliary characters** check box (1).
3. To log alarms (activation of a vibration sensor, temperature sensor, or Door-Forced-Open (DFO) sensor), select the **Alarm events** check box (2).
4. To log events related to system status, select the **System status** check box (3).
5. In the **Archive period (h)** field, enter the frequency, in hours, at which the log file is to be archived (4). Archives are saved in the DATA subfolder, with the following name format: namelog_yymmddhhmmss.gz, where
 - a. namelog is the name of the log file being archived;
 - b. yy is the year of archive creation;
 - c. mm is the month of archive creation;
 - d. dd is the day of archive creation;
 - e. hh is the hour of archive creation;
 - f. mm is the minute of archive creation;
 - g. ss is the second of archive creation.
6. In the **File size (MB)** field, enter the file size threshold, in megabytes, upon which the log file is archived (5). This setting overrides the value in the **Archive period (h)** field.
7. In the **Keep archives for (months)** drop-down list, select the length of time, in months, for which you want to store archived log files. This value must be between 1 and 24 (6). Archives that are older than the specified number of months are deleted.

To save settings, click the **Apply** button.

6.3.1 Specifying storage time for event log

To specify the term of keeping the event log in the database do the following:

1. Go to the **Programming** tab of the **System settings** dialog box (1).

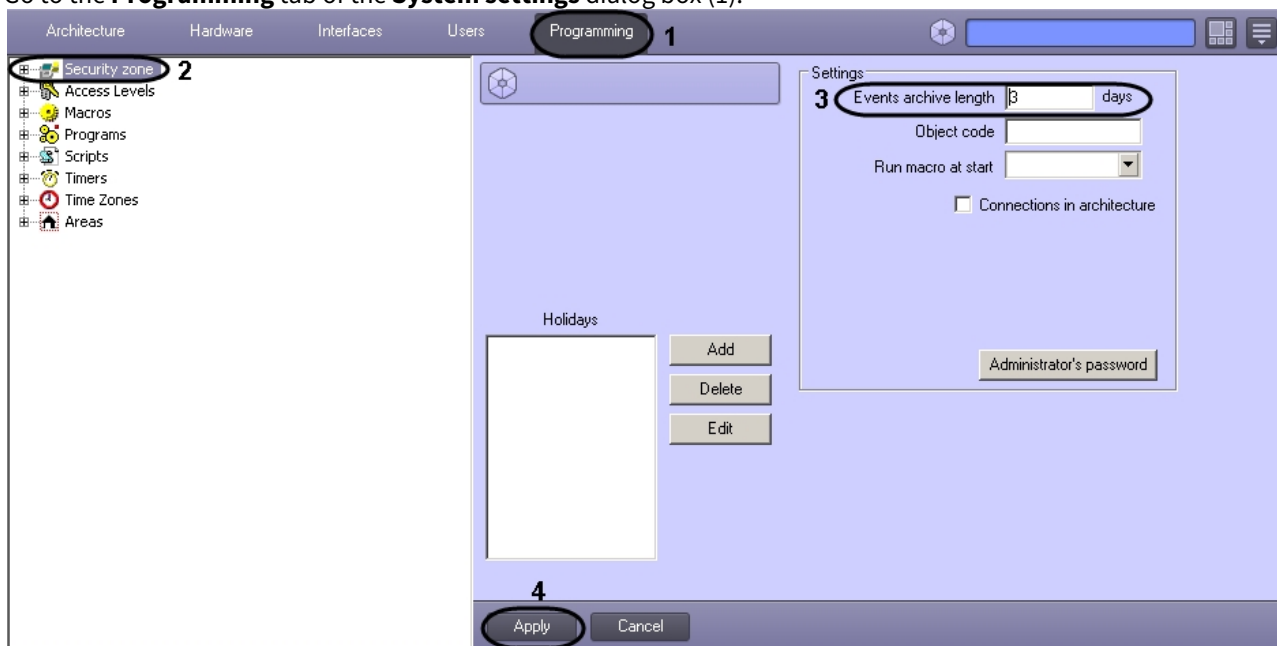

2. Go to the **Security zone** object setting panel (2).
3. Specify the term of keeping the event log in the **Event archive length** parameter (3).
4. Press **Apply** (4).

Specifying the term of keeping the event log is completed.

6.3.2 The Event Viewer utility

The disadvantage of viewing information via the *Event Viewer* is clearing the screen on each Intellect restart. It is impossible to see what was on before the system restart. The additional *Event Viewer* utility is required in such cases. This utility operates the database directly and allows to view information from the whole length of time used to keep the event log in the database.

To start the *Event Viewer* utility, click the **Event Viewer** button on the **Server of Control** settings panel.

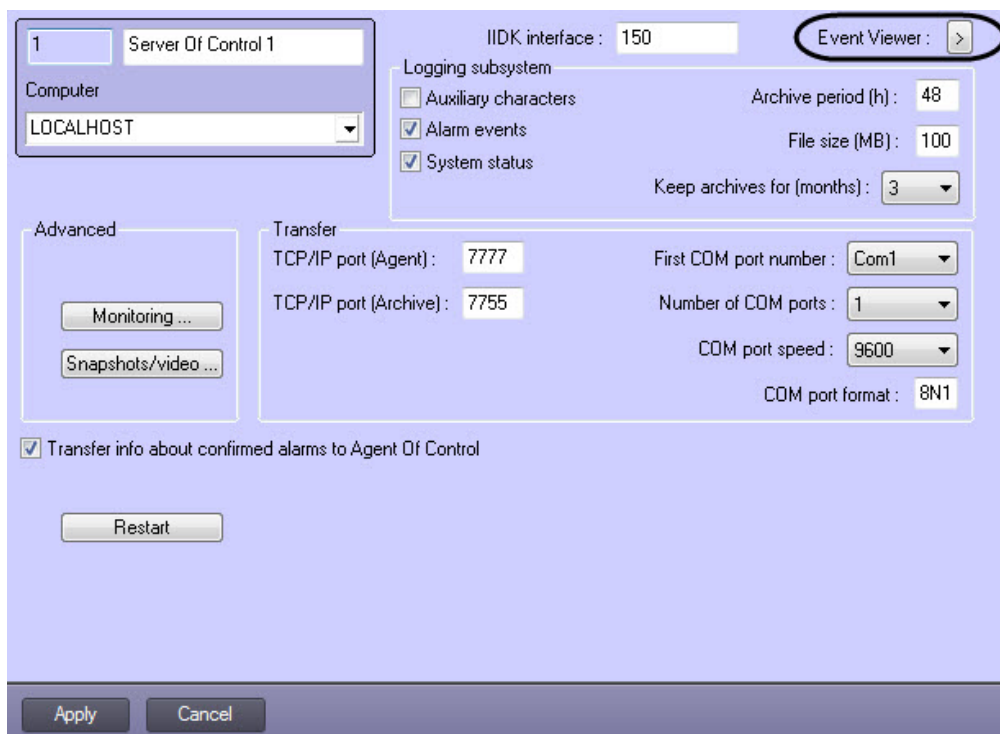

The *Event Viewer* utility allows to sort and filter data.

Source	Event	Additional information	Date	Time
10 Green spruce dr.	Detections	Abandoned object	28.06.2018 15:43:35	28.06.2018 15:4
10 Green spruce dr.	Detections	Abandoned object	28.06.2018 15:43:06	28.06.2018 15:4
10 Green spruce dr.	Detections	Abandoned object	28.06.2018 15:42:44	28.06.2018 15:4
10 Green spruce dr.	Detections	Abandoned object	28.06.2018 15:42:40	28.06.2018 15:4
10 Green spruce dr.	Detections	Abandoned object	28.06.2018 15:42:35	28.06.2018 15:4
10 Green spruce dr.	Camera enabled	Camera 2 [id=2]	28.06.2018 15:42:04	28.06.2018 15:4
10 Green spruce dr.	Camera enabled	Camera 3 [id=3]	28.06.2018 15:42:04	28.06.2018 15:4
10 Green spruce dr.	Camera enabled	Camera 4 [id=4]	28.06.2018 15:42:04	28.06.2018 15:4
10 Green spruce dr.	Camera enabled	Camera 5 [id=5]	28.06.2018 15:42:04	28.06.2018 15:4
10 Green spruce dr.	Archive size : enough	Camera 2 [060-003: Specified-Cur.(days)]	28.06.2018 15:42:04	28.06.2018 15:4
10 Green spruce dr.	Archive size : enough	Camera 3 [060-001: Specified-Cur.(days)]	28.06.2018 15:42:04	28.06.2018 15:4
10 Green spruce dr.	Archive size : enough	Camera 4 [060-001: Specified-Cur.(days)]	28.06.2018 15:42:04	28.06.2018 15:4
10 Green spruce dr.	Archive size : enough	Camera 5 [060-001: Specified-Cur.(days)]	28.06.2018 15:42:04	28.06.2018 15:4
47 John Reed str.	Camera enabled	Camera 1 [id=1]	28.06.2018 15:42:04	28.06.2018 15:4
47 John Reed str.	Archive size : enough	Camera 1 [060-005: Specified-Cur.(days)]	28.06.2018 15:42:04	28.06.2018 15:4
10 Green spruce dr.	Detections	Abandoned object	28.06.2018 15:41:45	28.06.2018 15:4
10 Green spruce dr.	Detections	Abandoned object	28.06.2018 15:41:00	28.06.2018 15:4

6.4 Configuring reaction to snapshots and videos

Monitoring allows configuring how the application reacts after receiving still frames or video that are sent when alarm sensors are triggered.

Note. These settings do not affect the acquisition of video data by the **Search in Archive** interface.

To configure the reaction to receipt of still frames and video:

1. Go to the configuration panel for the **Server of Control** object.

1 Server Of Control 1 IIDK interface : 150 Event Viewer : >

Computer LOCALHOST

Logging subsystem

Auxiliary characters Archive period (h) : 48

Alarm events File size (MB) : 100

System status Keep archives for (months) : 3

Advanced

Monitoring ...

Snapshots/video ...

Transfer

TCP/IP port (Agent) : 7777 First COM port number : Com1

TCP/IP port (Archive) : 7755 Number of COM ports : 1

COM port speed : 9600

COM port format : 8N1

Transfer info about confirmed alarms to Agent Of Control

Restart

Apply Cancel

2. Click the **Snapshot/Video** button. A window opens, allowing configuration of the application response to receipt of still frames and video.

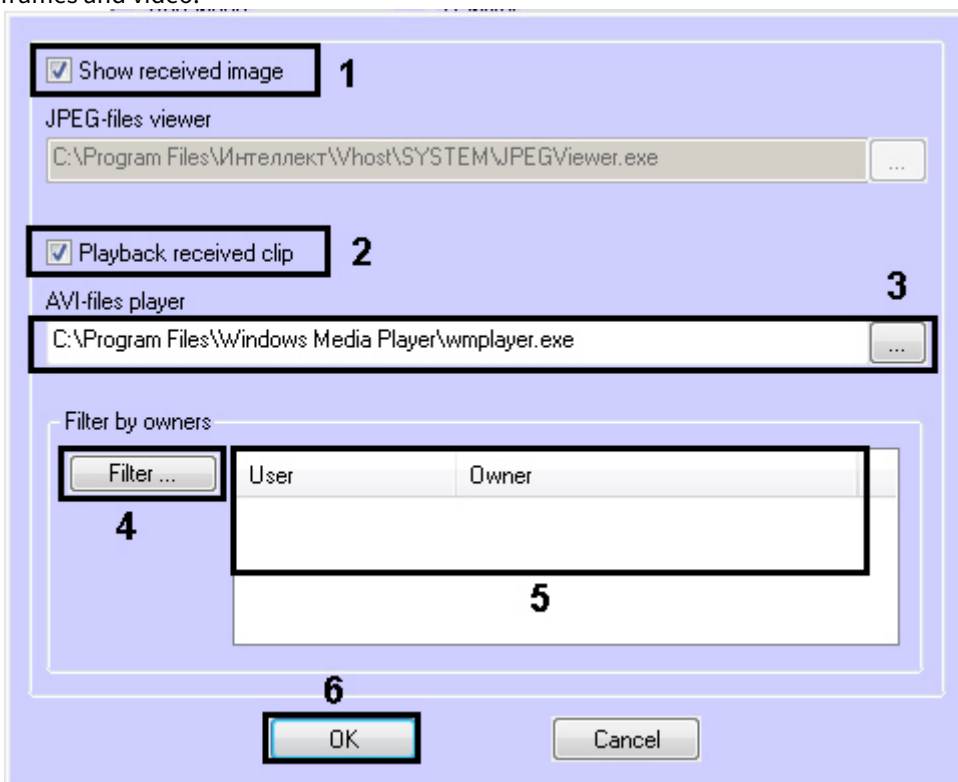

3. If you want for received still frames to be opened:
- a. Select the **Show received image** check box (1).
4. If you want for received video to be played back:
- a. Select the **Playback received clip** check box (2).
5. Specify the path to a program for playing back video files (3).

Note.

AVI-files player setting is only used for compatibility with Monitoring older versions which transmitted avi-files. Newer versions transmit files in the Intellect video archive format, which are opened with the Axxon Player utility.

6. If snapshots and videos only from sites belonging to specific owners are to be available for specific users, then set the filter by owners:
- a. Click the **Filter...** button (8).

- b. The **Filter by owners** window appears. The list of available user-owner pairs is on the left, the list of selected ones is on the right.

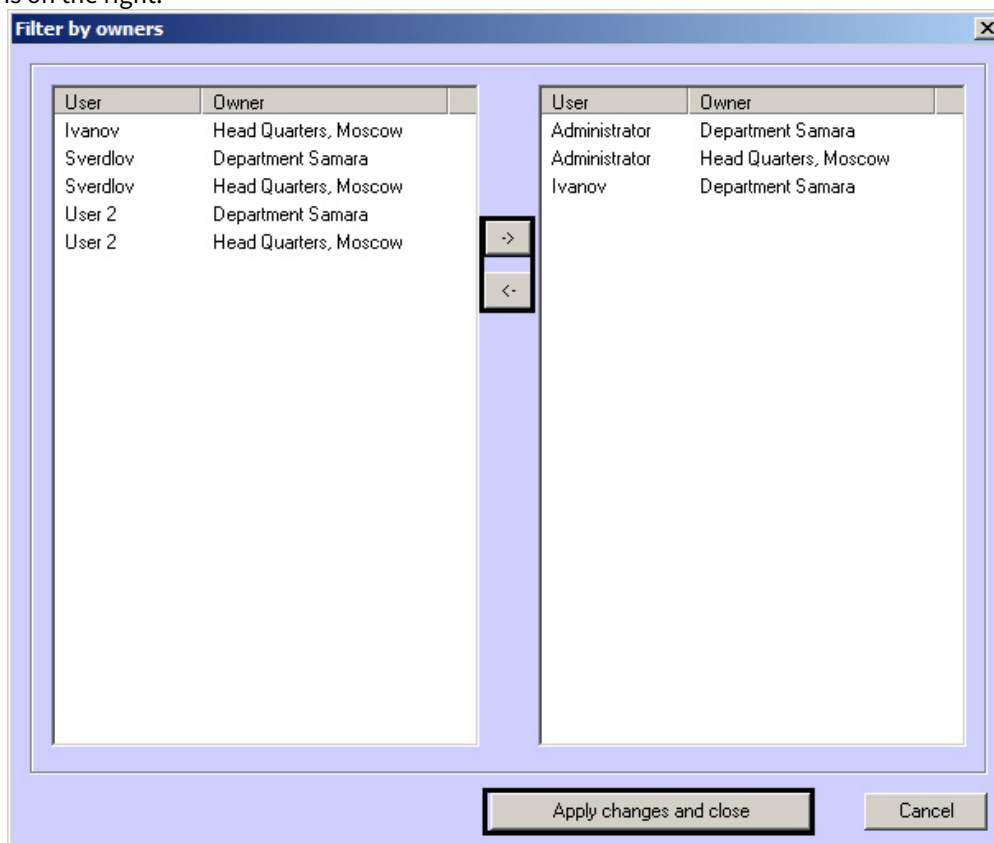

Note.

The list of owners is set on the Control Panel – see [Regulatory and reference information](#) section of [Operator's Guide](#).

Users and their rights are configured in the **Users** tab of the **System settings** dialog box – get information on how to do it in the *Intellect Software Package. Administrator's Guide*. The latest version of this document can be found in [AxxonSoft documentation repository](#).

- c. Move the pairs between the lists using the <- and -> buttons.
 - d. When the list of user-owner pairs is formed, click the **Apply changes and close** button.
7. Selected pairs of users and owners are displayed in the table (5).
 8. Click **OK** (6).

Configuration of the application reaction to receipt of video or still frames is now complete.

6.5 List of Additional workplaces

For the *Additional workplaces* software operation, it is necessary to configure the list of additional workplaces in the *Server of Control*, and specify the computer name and client code for each of them.

The client code is bound to the computer hardware. You can find it out as follows:

1. On the computer with installed *Monitoring* software, open the **Search in archive** interface in the Additional workplace configuration.

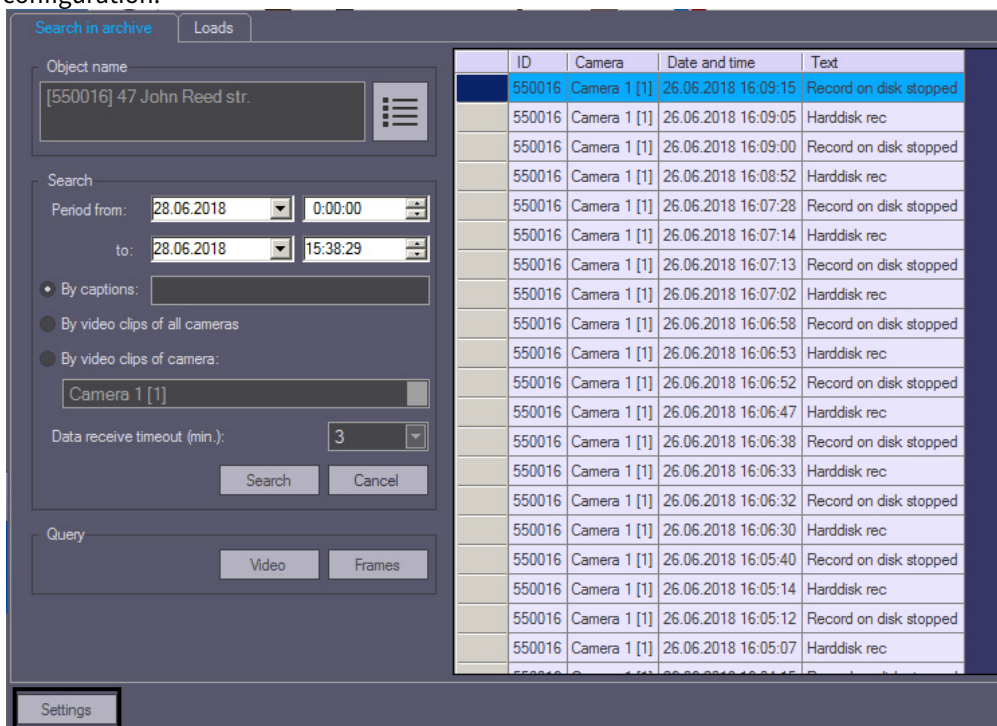

2. Click the **Settings** button in the bottom left corner.
3. The client code is specified in the appeared **Settings** box.

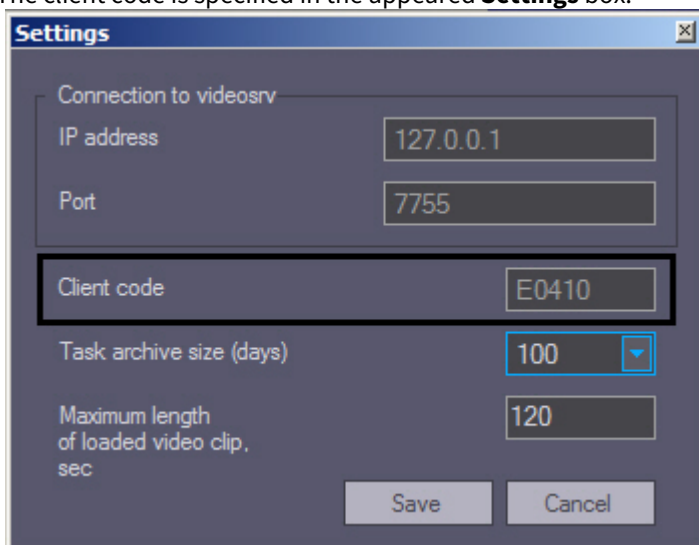

The list of Additional workplaces that can be connected to the *Server of Control* is configured as follows:

1. Go to the settings panel of the **Server of Control** object.

The screenshot shows the settings panel for a 'Server of Control' object. The 'Computer' is set to 'LOCALHOST'. The 'IIDK interface' is '150' and the 'Event Viewer' is open. Under 'Logging subsystem', 'Alarm events' and 'System status' are checked. The 'Archive period (h)' is 48, 'File size (MB)' is 100, and 'Keep archives for (months)' is 3. In the 'Advanced' section, the 'Monitoring...' button is circled in red. The 'Transfer' section shows 'TCP/IP port (Agent): 7777', 'TCP/IP port (Archive): 7755', 'First COM port number: Com1', 'Number of COM ports: 1', 'COM port speed: 9600', and 'COM port format: 8N1'. A checkbox for 'Transfer info about confirmed alarms to Agent Of Control' is checked. 'Restart', 'Apply', and 'Cancel' buttons are also visible.

2. Click the **Monitoring...** button. As a result, the box for configuring the list of Additional workplaces appears.

The screenshot shows the 'Additional workplaces' configuration dialog box. It has a table with two columns: 'Computer name' and 'Client code'. The table is currently empty. Below the table are three buttons: 'Add...', 'Edit...', and 'Delete'. The 'Add...' button is highlighted with a red box. At the bottom of the dialog are 'OK' and 'Cancel' buttons.

3. To add an Additional workplace to the list, click the **Add...** button.

- In the appeared box specify the computer name on which the Additional workplace is installed (1).

- Specify the client code in the **Client code** field (2).
- Click the **OK** button (3).
- Repeat steps 3-6 for all Additional workplaces that will be connected to this *Server of Control*.

Note.

To edit specified settings select the Additional workplace in the list and click the **Edit...** button.
To delete the Additional workplace in the list select it in the list and click the **Delete** button.

- Click the **OK** button.
- Click the **Apply** button.

The list of Additional workplaces is now configured.

6.6 Sending confirmations of alarm acceptance

In general the *Agent of Control* is considered not to have the same core with the *Server of Control*.

It is possible to configure sending messages to *Agent of Control* when the operator confirms an alarm on the *Server of Control*. The *Agent of Control* then sends these messages to *Intellect* core. Two types of confirmation are available: simple and complex. The confirmation type is selected when configuring alarm transmission to the *Server of Control* (see [Configuring alarm groups](#) section).

When the confirmation is sent, the *Server of Control* waits for the confirmation from the *Agent of Control* that the message has been sent to *Intellect* core. If this message is not received, then confirmation packets are sent every 5 minutes.

Note.

See also [Sample scripts for processing alarm confirmations](#) section.

Disable sending confirmations of alarm acceptance as follows:

- Go to the settings panel of the *Server of Control* object.

2. Clear the **Transfer info about accepted alarms to Agent of Control** check box.

3. Click the **Apply** button.

The **Transfer info about accepted alarms to Agent of Control** function is now disabled.

6.7 Working with Server of Control without Windows administration rights

To allow the user not added to the Administrators group in the Windows operating system to work correctly with *Server of Control*, make sure the following conditions are fulfilled:

1. The user must have full access to the *Server of Control* registry section:
HKEY_LOCAL_MACHINE\Software\BitSoft for 32-bit system
(HKEY_LOCAL_MACHINE\Software\Wow6432Node\BitSoft for 64-bit).
2. The user must have full right on the **Export** folder. The path to this folder is stored in the ExportPath parameter in the following registry section:
HKEY_LOCAL_MACHINE\Software\BitSoft\VHOST\VHostService for 32-bit system
(HKEY_LOCAL_MACHINE\Software\Wow6432Node\BitSoft\VHOST\VHostService for 64-bit).

6.8 Configuring sound notification at Server of Control

6.8.1 Configuring sound notification at Server of Control in a general way

The *Monitoring* software allows configuring audio feedback for alarms received from an *Agent of Control*. For this do the following:

Note.

This function is not supported for the Additional Workplace in non-distributed configuration.

1. Create a **Display** object in the **Interfaces** tab.
2. Create an **Audio player** object on the base of the **Display** object.
3. Run the *System configuration* utility (ddi.exe).

Note.

Detailed info on using this utility is given in the *Intellect software. Administrator's Guide*. The most relevant version of this document is available in [AxxonSoft documentation repository](#).

4. Open the intellect.atm.ddi file.
5. Select the VIDEOSRV_S_DVC (**Partition of control**) object.
6. Go to the **Events** tab.

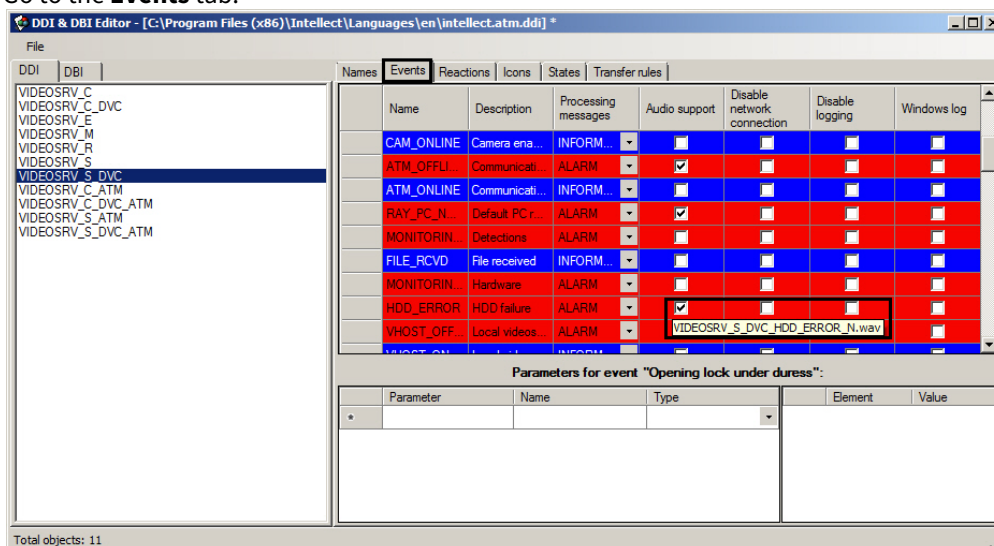

7. In the **Audio support** column set checkboxes for all events that have to be followed by an audio signal. A screentip shows the required name of the wav file. N is an ID of the VIDEOSRV_S_DVC_ATM object.
8. Create corresponding files and put them to the <Intellect installation>\Wav folder.

Configuration of sound notification at *Server of Control* is completed.

6.8.2 Configuring sound notification at Server of Control for various alarm groups

There are 4 alarm groups in the *Monitoring* software. Several different events can be assigned to them at the *Agent of Control*. These groups are: **Equipment, ACS, FSA, Detections** (see [Configuring alarm groups](#)).

In order to configure sound notification for alarm groups do the following:

Note.

This function is not supported for the Additional Workplace in non-distributed configuration.

1. Create and configure the **Display** and **Audio player** objects in the **Interfaces** tab of the **System settings** dialog box.
2. Run the *System configuration* utility (ddi.exe).
Note. Detailed info on using this utility is given in the *Intellect software. Administrator's Guide*. The most relevant version of this document is available in [AxxonSoft documentation repository](#).
3. Open the intellect.atm.ddi file, select the VIDEOSRV_S_DVC (**Partition of control**) object.

4. Go to the **Events** tab.

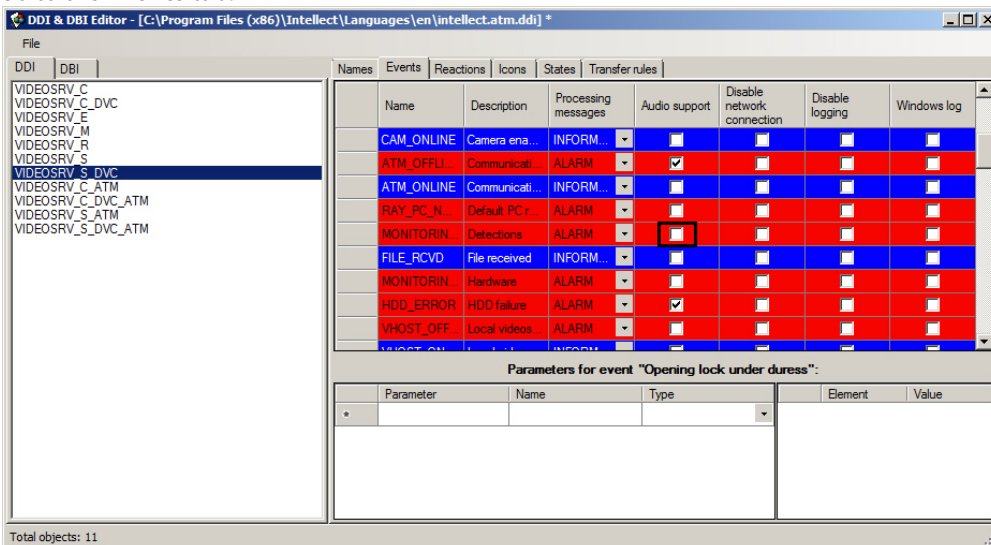

5. Make sure that the **Audio support** is not set for the **Detections** event.
6. Close the *System configuration* utility.
7. Create and configure the **Program** object in the **Programming** tab of the **System settings** dialog box.

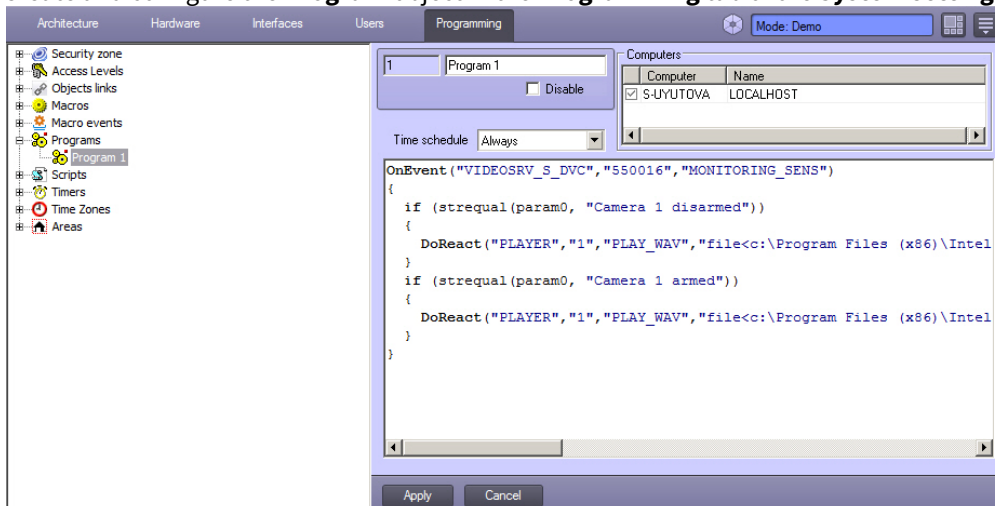

Example of a program for alarm groups shown on the picture:

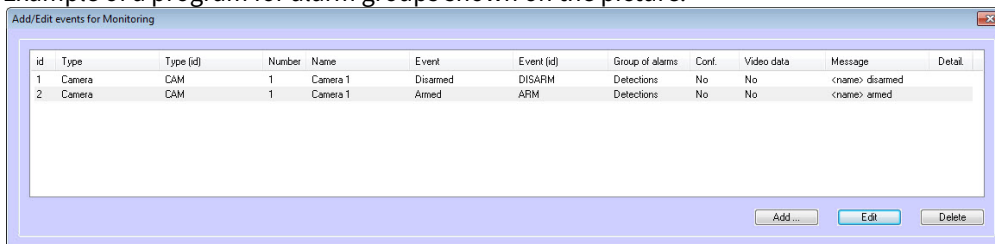

```

OnEvent("VIDEOSRV_S_DVC","550016","MONITORING_SENS")
{
  if (strequal(param0, "Camera 1 disarmed"))
  {
    DoReact("PLAYER","1","PLAY_WAV","file<c:\Program Files
(x86)\Intellect\Wav\cam_disarm.wav>");
  }
  if (strequal(param0, "Camera 1 armed"))
  {
    DoReact("PLAYER","1","PLAY_WAV","file<c:\Program Files
(x86)\Intellect\Wav\cam_arm.wav>");
  }
}

```

8. Create corresponding files and put them to the <Intellect installation>\Wav folder.

Configuration of sound notification at Server of Control for various alarm groups is completed.

6.9 Creating and configuring Data gateway

Data gateway is needed when live video is transmitted from *Agent of Control* to *Additional workplace* in another subnet and *Monitoring* software components are not united in the distributed video surveillance system, as so as in this case **Video gate** object cannot be used.

The **Data gateway** objects are created on the computers with *Server of Control* installed. The number of the **Data gateway** objects must be equal to the number of *Agent of Control* to receive live video from. For example, if there are 10 **Agents of Control**, then create 10 **Data Gateways** with **Local port** and **Remote IP-address** corresponding to those *Agents of Control*.

In this section, the description of **Data gateway** configuration is given. By default, this module is not enabled for live video transmitting to *Additional workplaces*. In order to enable Data gateway, set the **View live video through the gate** in the **Monitoring** interface object settings panel – see [Configuring the Monitoring interface object](#).

Data gateway object configuration is performed as follows:

1. Create the **Data gateway** object based on the **Computer** object on the **Hardware** tab of the **System settings** dialog box (1).

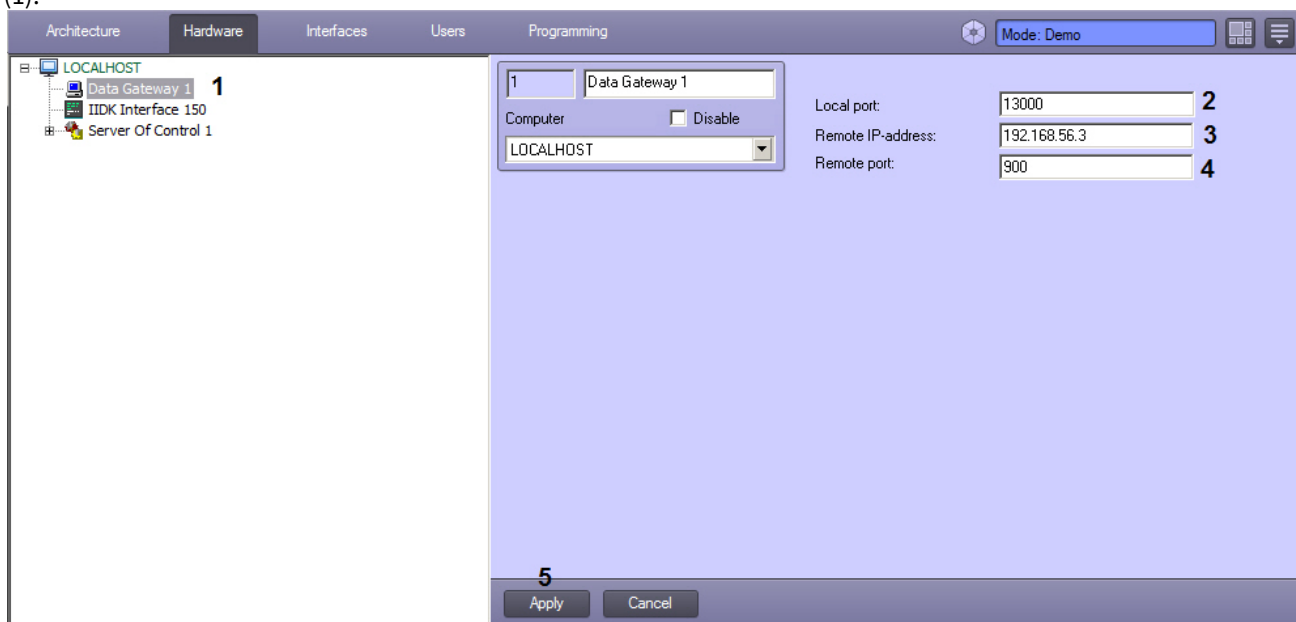

2. In the **Local port** field enter the number of the port in the system for connection of *Additional Workplaces* (2).
3. In the **Remote IP-address** field enter IP-address of the *Agent of Control* (3).

4. In the **Remote port** field enter the standard port of the *Agent of Control* intended to transmit live video (4). Do not change the default value in most cases. It is to be changed only if by some reason the system uses intermediate server with port forwarding.
5. Click **Apply** (5).

Data gateway object configuration is completed.

7 Configuring Central server of control

7.1 General principles of the Central server of control software

8 Configuring Additional workplace

8.1 List of Servers of Control

Additional workplace can operate with only one *Server of Control* at a time. However, the list of available *Servers of Control* can be configured and the active *Server of Control* can be selected. For this use the *Additional workplace configuration tool*. The tool can be run in one of the following ways:

1. Click **Start -> All Programs -> Intellect -> Monitoring -> Additional workplace configuration tool**.
2. Use the ARMSelector.exe executable file, located in the <Intellect installation directory>\VHost\SYSTEM\ folder.

The tool is shown in the figure.

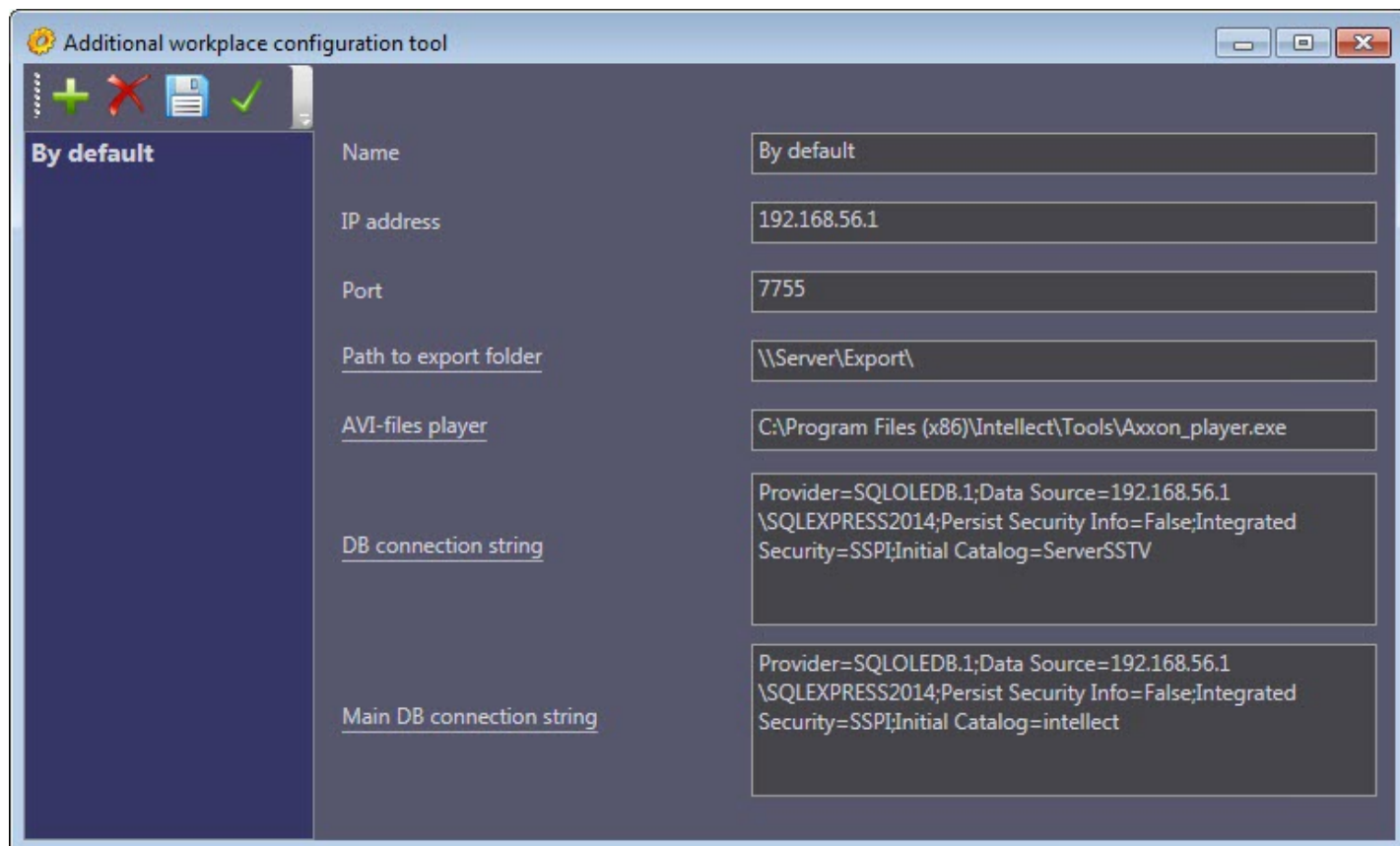

See [Interface of Additional workplace configuration tool](#) for parameters description.

8.1.1 Interface of Additional workplace configuration tool

Interface elements of *Additional workplace configuration tool* are described in the table.

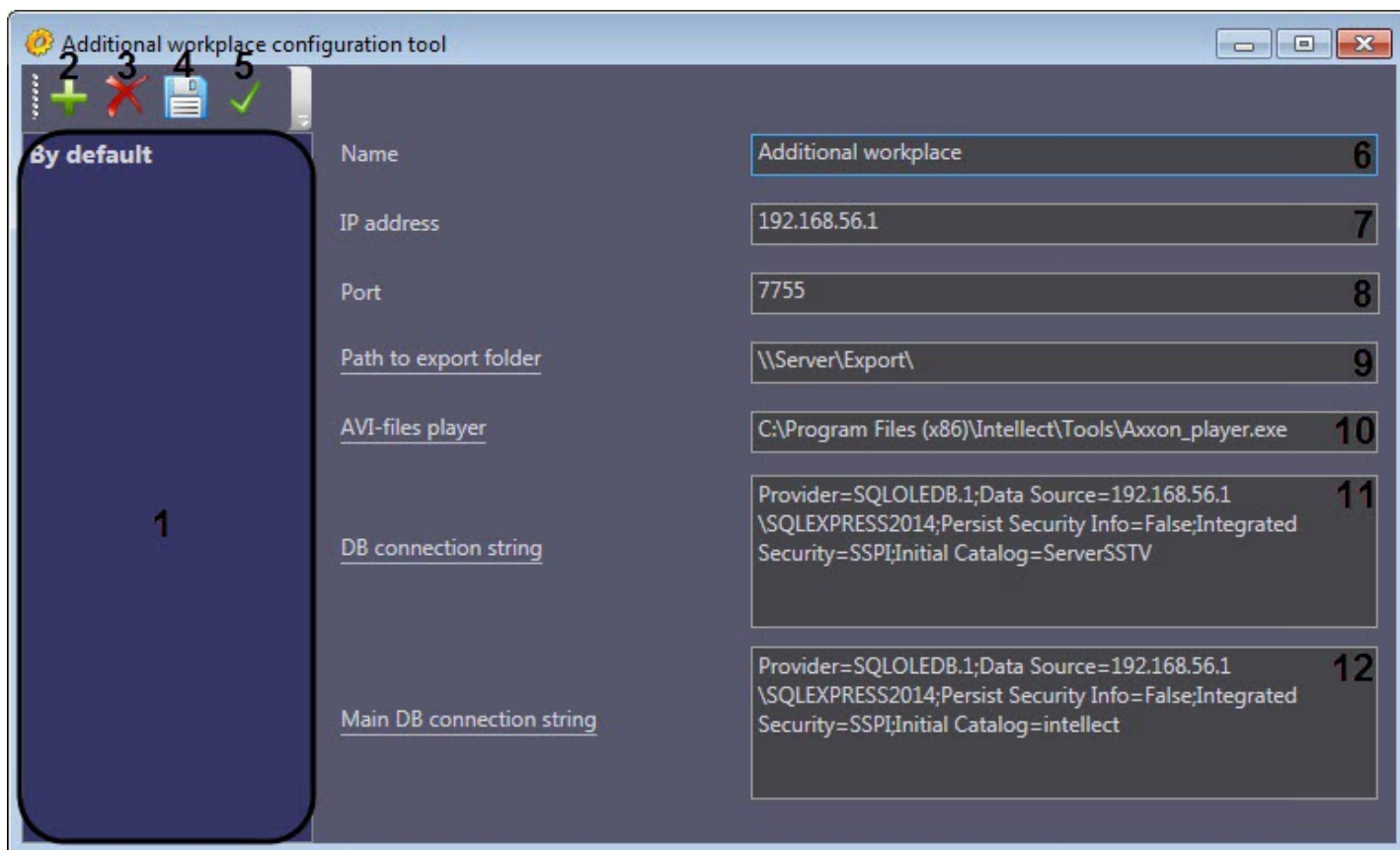

#	Name	Method of setting the parameter value	Default value	Description
1	List of Servers of Control	The Add , Remove and Set as active buttons	By default there is the <i>Server of Control</i> in the list. It is named By default and is created during installation.	Displays the list of existing <i>Servers of Control</i> . An active <i>Server of Control</i> is highlighted in bold.
2	The Add button	Click the button	-	Adding a new <i>Server of Control</i> to the list.
3	The Delete button	Click the button	-	Deleting a selected <i>Server of Control</i> from the list.
4	The Save button	Click the button	-	Saving the changes
5	The Set as active button	Click the button	-	Setting an active <i>Server of Control</i> .
6	The Name field	Enter a value in the field	See #1. When a new <i>Server of Control</i> is added to the list it is named New by default.	Setting a name for <i>Server of Control</i> . This name is used only in this tool.
7	The IP address field	Enter a value in the field	127.0.0.1 Important! The value of this parameter is to be changed according to the IP address of the <i>Server of Control</i> .	Setting the IP address to connect to VideoSrv module.

8	The Port field	Enter a value in the field	7755	Setting a port to connect to VideoSrv module. The port used by the <i>Server of Control</i> is specified on the settings panel of the corresponding object when setting the <i>Server of Control</i> - see Configuring a connection section.
9	The Path to export folder field	The Path to export folder link or enter a value in the field	-	Setting a path to the network folder on the <i>Server of Control</i> where there are archive files requested from the <i>Agent of Control</i> .
10	The DB connection string field	The DB connection string link	-	Setting the <i>Server of Control</i> DB connection string. The Data Link Properties box appears when clicking the DB connection string link.
11	The Main DB connection string field	The Main DB connection string link	-	Setting the base <i>Intellect</i> DB connection string. The Data Link Properties box appears when clicking the Main DB connection string link.

8.1.2 Adding Server of Control to the list

By default the *Server of Control* (named “By default”) is added to Additional workplace configuration right after installation of *Monitoring* software package. Its settings are the same as those specified during installation (see [Additional workplace Installation](#) section).

Add a new *Server of Control* to the list as follows:

1. Run *Additional workplace configuration tool*.

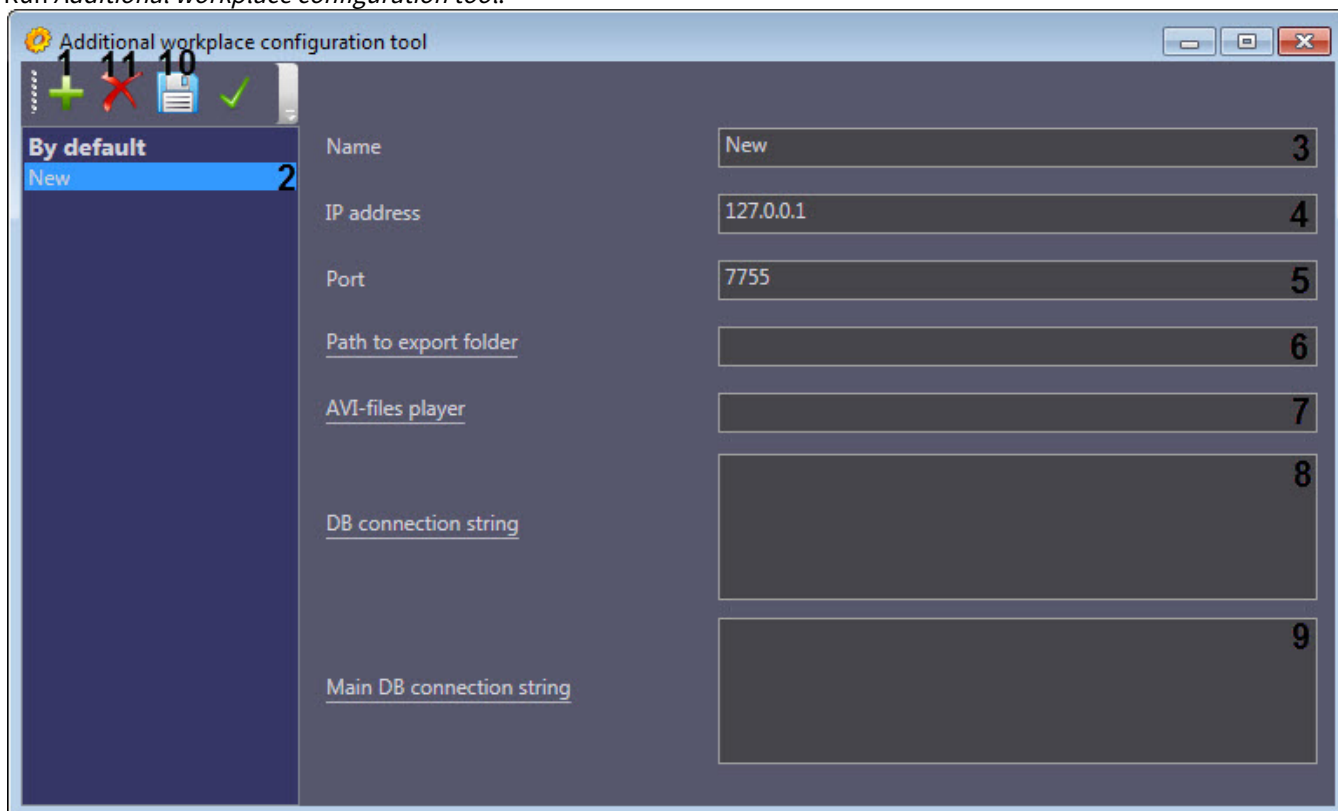

2. Click the  button (1).
3. A new Server of Control is added to the list (named **New**) (2).
4. Rename the *Server of Control* if necessary (3).

Note.

This name is used in the *Additional workplace configuration tool* only.

5. Specify the IP address of computer where VideoSrv module is run (4).
6. Specify the VideoSrv module connection port (5).

Note.

The port used by the *Server of Control* is specified on the settings panel of the corresponding object when setting the *Server of Control* - see [Configuring a connection](#) section.

7. Specify the path to network folder on the *Server of Control* where there are archive files requested from the *Agent of Control* (6). A *standard Browse for Folder dialog box* appears when clicking the **Path to export folder** link. Select a required folder.

Note.

By default the folder (Export folder) on the *Server of Control* where the snapshots and videos are stored is located at DISK:\Export\, where DISK is a disk with installed OS. You can edit the folder by editing the **ExportPath** registry value in the HKLM\Software\BITSoft\VHost\VHostService section for 32-bit OS (HKLM\Software\Wow6432Node\BITSoft\VHost\VHostService for 64-bit).

8. Click the **DB connection string** link. The **Data Link Properties** box appears. Configure DB connection to remote *Server of Control* as follows:

- a. Go to the **Provider** tab. Select **Microsoft OLE DB Provider for SQL Server**.

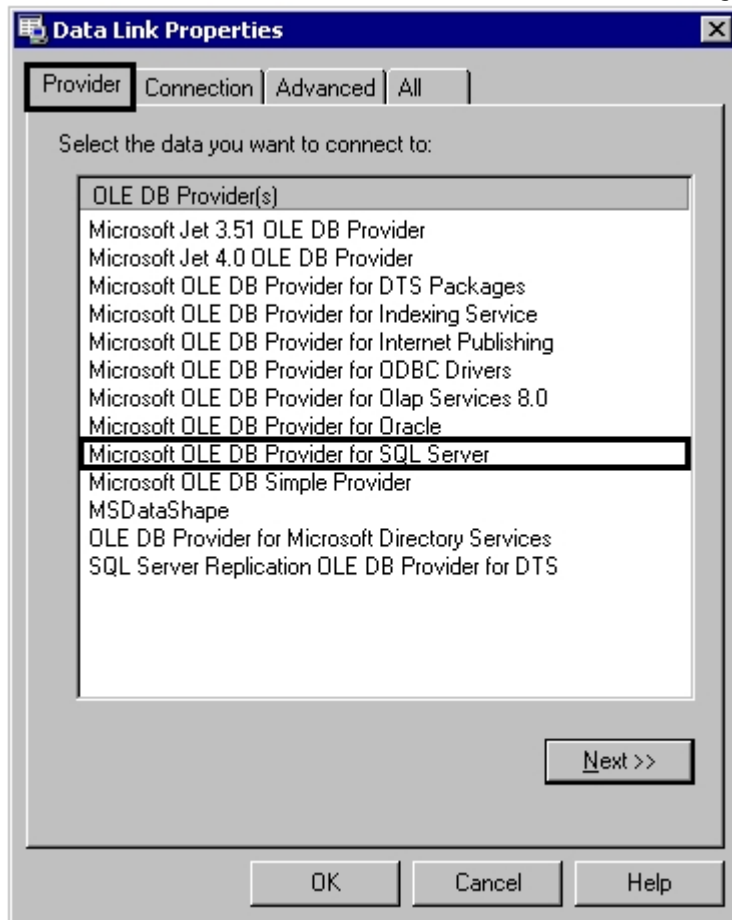

- b. Go to the **Connection** tab.

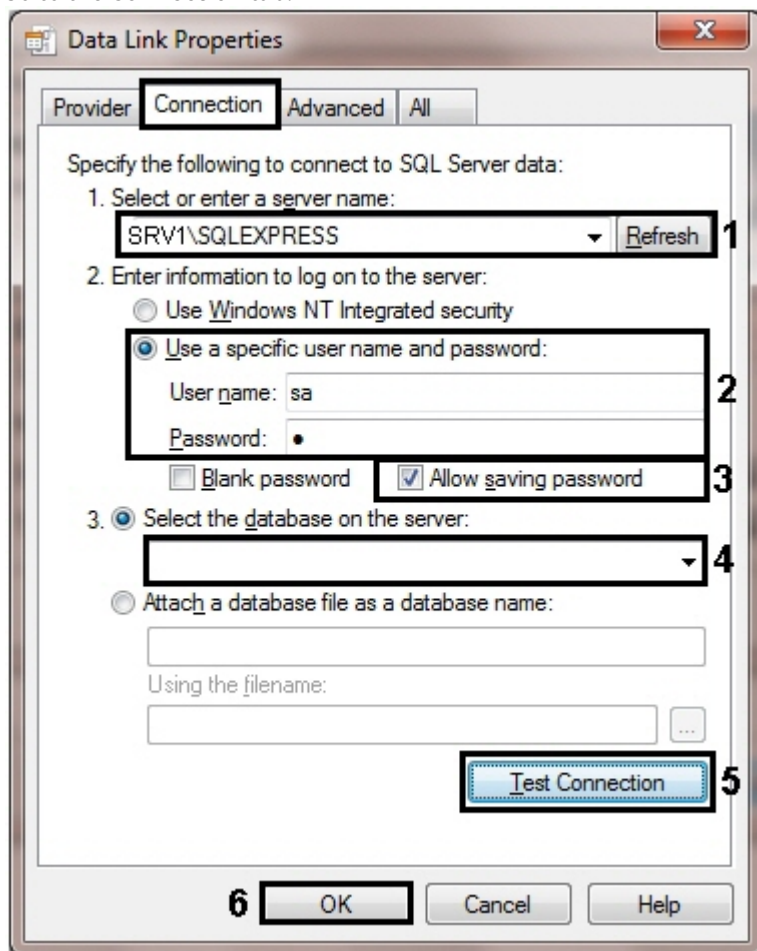

- c. In the **1. Select or enter a server name:** dropdown list select a name of DB server where the *Server of Control* DB is stored (1).
- d. Set the **2. Enter information to log on to the sever:** to the **Use a specific user name and password:** position and specify the user name and password to connect to MS SQL Server (2).
- e. Select the **Allow saving password** check box (3).
- f. In the **Select the database on the server:** dropdown list select the name of the *Server of Control* DB (4).
- g. Click the **Test Connection** button (5). If connection data is specified correctly, then the box with the **Test connection succeeded** message appears.

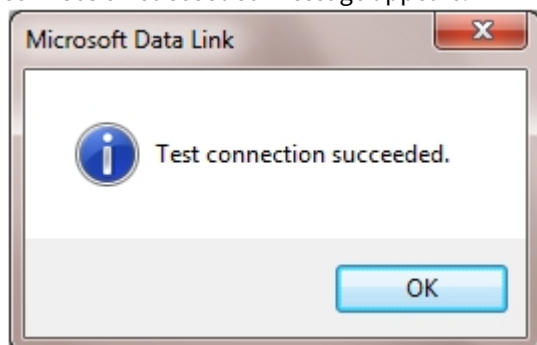

Note.

If there is the **Connection failed** message, then check if there is connection to the *Server of Control* computer and if the server DB is configured correctly and then repeat steps 8.a-8.g.

- h. Click the **OK** button(6).

9. The configured connection string is displayed in the text field (8).

10. Click the **Main DB connection string** link (9). The **Data Link Properties** box appears. Configure DB connection to the base *Intellect* DB similarly to the *Server of Control* (see steps 8.a-8.h). The configured connection string is displayed in the text field (10).
11. Click the  button to save the changes (11).

Note.

To remove *Server of Control* in the list select it and click the  button.



Server of Control is now added to the list.

8.1.3 Selecting active Server of Control

Select an active *Server of Control* used by the Additional workplace as follows:

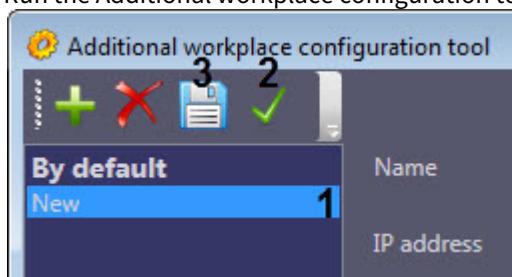
1. Run the Additional workplace configuration tool.



2. Select the required *Server of Control* in the list (1).
3. Click the  button (2).
4. Click the  button (3).

Active *Server of Control* is now selected.

8.2 Working with Additional workplace without Windows administration rights

To allow the user not added to the Administrators group in the Windows operating system to work correctly with *Additional workplace*, make sure the user has the full access to the *Additional workplace* registry section:

HKEY_LOCAL_MACHINE\Software\BitSoft for 32-bit system
 (HKEY_LOCAL_MACHINE\Software\Wow6432Node\BitSoft for 64-bit).

9 Data Loader for Monitoring

9.1 Server of Control

Server of Control is a communication module that is responsible for receiving information from objects. The icon of the module (a red "V" symbol) is shown in the toolbar, in the lower-right corner of the screen.



If you double click on the icon, the window shown in the following figure opens.

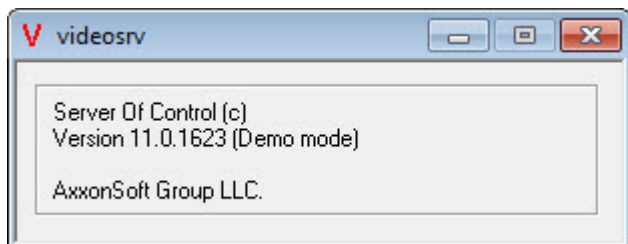

Server of Control starts automatically. If *Server of Control* has been stopped by mistake or any other reason, it can be restarted from **Start – All programs – Intellect – Monitoring – VideoSrv** menu.

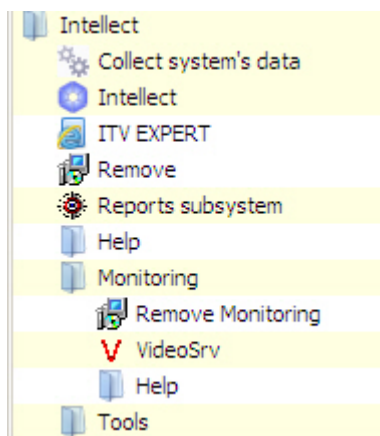

9.2 Data Loader for Monitoring

Server of Control creates files that contain object status information and puts them in the exchange folder. The files are then loaded from the folder to the database by the *Data loader for Monitoring* module. The icon of the module (a "monitor" symbol) is shown in the toolbar, in the lower-right corner of the screen.

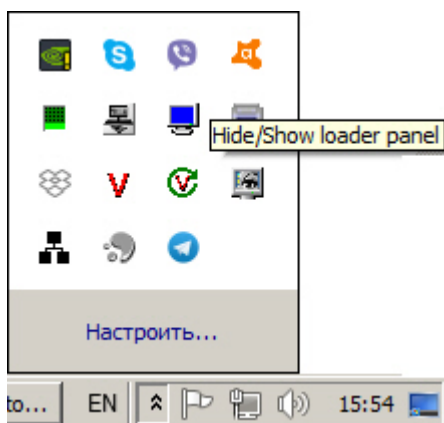

If you right-click on this icon, a context menu opens.

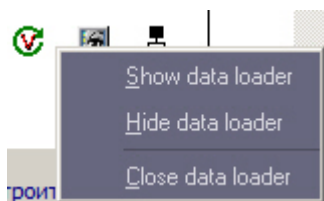

If you select the **Show data loader** menu item, the **Data loader for Monitoring** window opens.

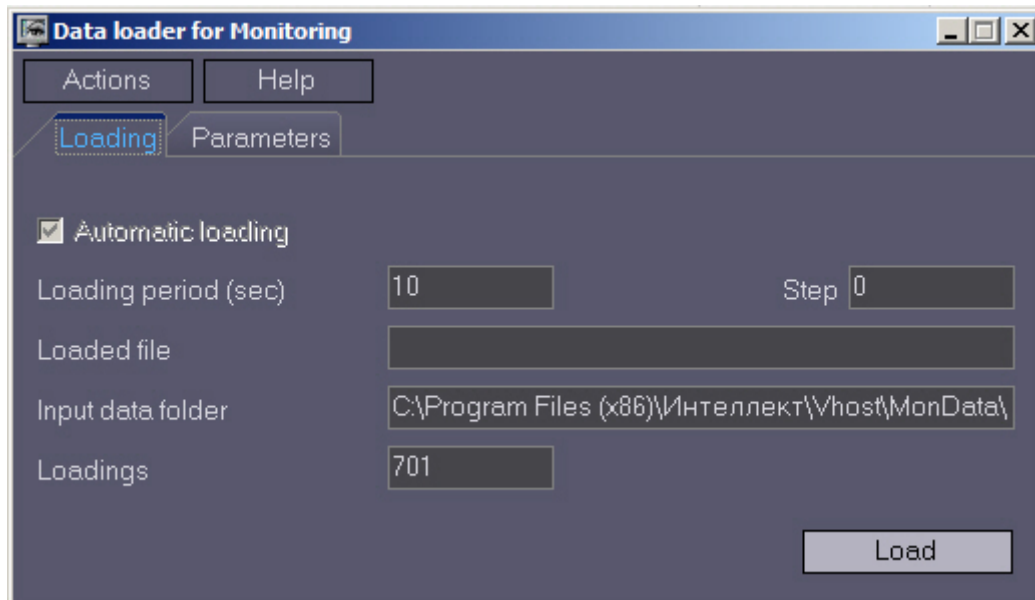

This window contains the following parameters:

1. **Input data folder:** The path to the folder that contains incoming files from *Server of Control*.
2. **Loading period (sec):** The time (in seconds) between two consecutive loads of incoming files from *Server of Control* into the database. This parameter applies to non-alarm messages. Alarm messages are recorded to the database immediately. Each time after data is loaded into the database, the system sends to the **Log Panel** interface component a data update request. The Log Panel refreshes the information from the database every minute.
3. **Automatic loading:** If you select this check box, data is loaded automatically. Otherwise, the load starts only when you click **Load**.
4. **Loaded file:** This field shows the name of the file being processed, or an error message if an error occurred while loading the data.
5. Message files received from *Server of Control* are processed in several steps. The current step is shown in the **Step** field.

9.3 Connecting to the database

To configure the database connection string, select the **Connection to database** item in the **Actions** menu.

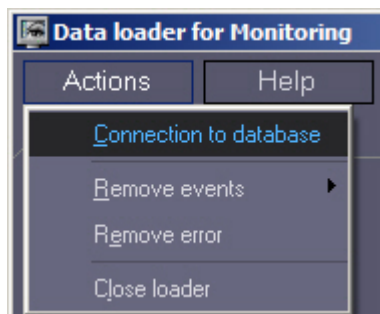

Attention!

If the location of the MonitorSSTV database changes from local to remote, then it is necessary to set the **0** value for the **UseBulkInsert** registry, if it changes from remote to local, then set the **1** value (for details, see [Registry keys reference guide](#), for more information about working with the registry, see [Working with Windows OS registry](#)).

9.4 Removing errors

If there was a failure while loading data, you cannot close the program in a usual way, because the loading process cannot be interrupted. To close the program, use the **Remove error** menu item.

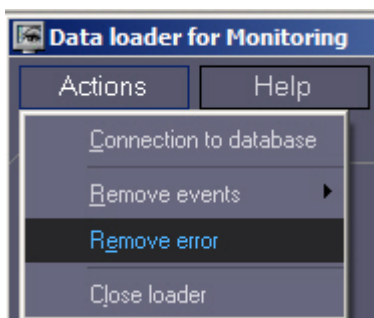

9.5 Removing events from the database

The **Remove events** menu item allows you to clear database. You can use the following modes:

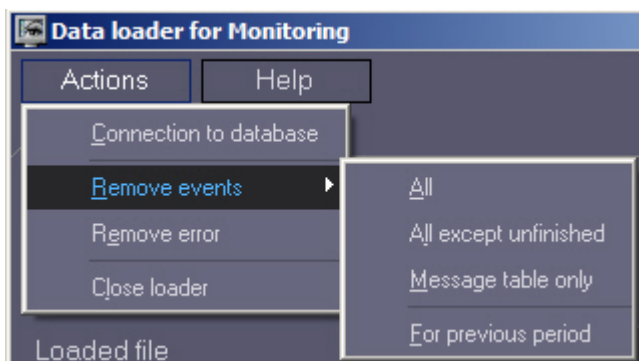

1. **Full** – Clears the database from alarms completely.
2. **All except incomplete** – Clears the database from alarms completely, but leaves the information on the start of the alarm for those alarms that did not yet end (long-term alarms).
3. **Message table only** – Clears the message log. This allows you to decrease the size of the database. In **Settings** tab, you can specify how long messages are kept in the log (see [Setting the log storage period](#)).
4. **For the period** – Clears the data for a specified period.

9.6 Setting the log storage period

If you want to specify how long the *Data loader* messages are kept in the log (event log), go to the **Data loader for Monitoring** window and then to the **Settings** tab.

The data loader's event log is stored in the <Intellect software installation folder>\VHost\MONITOR\LOADER\LoaderSSTV_L_M.log, where M is a month.

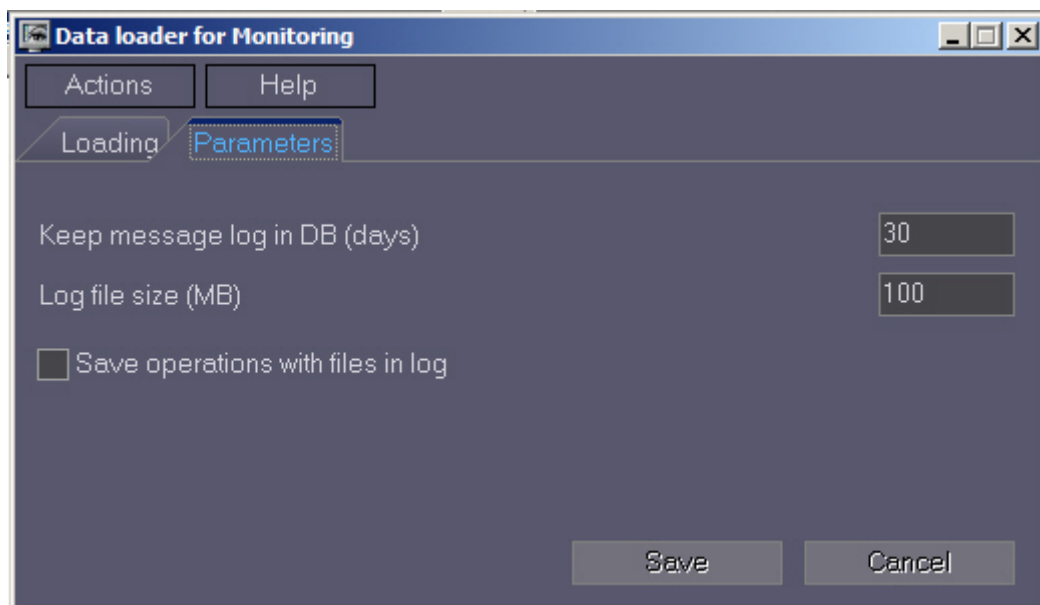

1. **Keep messages log in DB (days):** You can specify for how long will the data be kept in the MonitorSSTV database tables.
2. **Log file size (MB) :** You can specify the file size for the data loader's event log (in megabytes). After this limit is reached, the log file is archived.
3. **Save file operations in log:** This allows you to save details for the data loader's file operations in the data loader's event log.

9.7 Configuring automated video clip loading

To enable automated video clip loading, set the **FileQueryEnable** key in the Windows registry to 1 and specify folder to share data with third party system in the **FileQueryPath** key (see [Registry keys reference](#) guide for more details on the key and the [Working with Windows OS registry](#) section of *Intellect software. Administrator's Guide* for more details on how to operate registry keys). Restart the computer to ensure the changes applied.

Note.

The **C:\Query** folder is set by **FileQueryPath** key by default.

Important!

Specify different folders in **FileQueryPath** key if automated video clip loading is enabled both on *Server of Control* and *Additional workplace* simultaneously.

Note.

When *videosrv.exe communication module* starts at the *Server of Control*, the folder specified in the **FileQueryPath** key is automatically created with the following subfolders:

In – the folder for request files;

In\Work – the service folder for request files;

OutSuccess – the folder to place request files in after successful load of the video clips;

OutError – the folder for incorrect request files or request files with absent mandatory parameters;

OutFail – the folder to place correct request files in if video clip could not be loaded for some reason.

 **Important!**

At *Additional workplace*, create the folder specified in the **FileQueryPath** key with all subfolders described above manually.

10 Configuration of the Monitoring interface

10.1 General information about the Monitoring interface

The Monitoring interface is accessible through the following interface elements

1. **Monitoring**
2. **Search in archive**
3. **Monitoring Reports**

These objects are created based on the **Display** object, in the **Interfaces** tab of the **System settings** dialog box. It is recommended to create these objects on the basis of different **Display** objects.



Interface objects are available at the following *Monitoring* installation types: *Server of Control*, *Additional workplace*.

Note.

Operations with interface objects are described in the [Monitoring. Operator's Guide document](#).

10.2 Configuring the Monitoring interface object

Important!

Before creating the **Monitoring** object, create and configure the **Server of Control** object (see [Creating necessary Server of Control objects](#)).

To configure the **Monitoring** interface object:

1. In the object tree, select the **Monitoring** object. On the right side of the **System settings** dialog box, the configuration panel for the relevant object is displayed.

2. If it is necessary to display the **Owner Panel** component on the screen, select the **Owner Panel** check box and specify the component coordinates the on-screen coordinates of the component (1).
3. If it is necessary to display the **Control Panel** component on the screen, select the **Control Panel** check box and indicate the on-screen coordinates of the component (2).
4. If it is necessary to display the **Log Panel** component on the screen, select the **Log Panel** check box and indicate the on-screen coordinates of the component (3).
5. To require that operators leave comments when accepting an alarm (to describe the alarm and/or their actions), select the **Non-empty Comments field** check box (4). These comments can later be reviewed in the event log, which also indicates the operator that accepted the alarm.
6. By default, objects can be filtered by **Alarm** and **Failure** events as well as by **Connected** and **Disconnected** states on the Control Panel. Uncheck the **Use filter by events** box to disable this feature (5). As a result, the corresponding drop-down list becomes disabled on the Control Panel.
7. If when live video is attempted to be viewed from Control Panel it is necessary to display a warning that it can create the critical load per channel, set the **Warning when watching live video** checkbox (6).
8. If Agents of Control and Additional workplaces are in different subnets and the *Monitoring* components are not in a distributed system configuration in *Intellect* object tree and **Data gateway** is in use for transmission of live video to *Additional workplaces*, set the **Viewing live video through gateway** checkbox (7).

Note

For the details about the **Data gateway**, see [Creating and configuring Data gateway](#).

9. To add the "All cameras of Partition of Control" item to the object's "Video image playback" context menu on the Control Panel which enables viewing video from all cameras of the selected Partition of Control, set the **Viewing live video from all cameras (add.)** checkbox (8).
10. In the **Video stream speed** field specify the frame rate for live or archive video displaying in frames per second (9).

Note.

For the archive video, the **Video stream speed** setting only works with CamMonitor.ocx 4.11.0.1766 or later versions.

11. Select the required compression rate for the live video in the **Compression** drop-down list (10).
12. For the alarms that you want to visualize, select the corresponding check boxes (11).
13. If specific owners are to be available for specific users on the Owner Panel, then set the filter by owners:
 - a. Click the **Filter...** button (12).
 - b. The **Filter by owners** window appears. The list of available user-owner pairs is on the left, the list of selected ones is on the right.

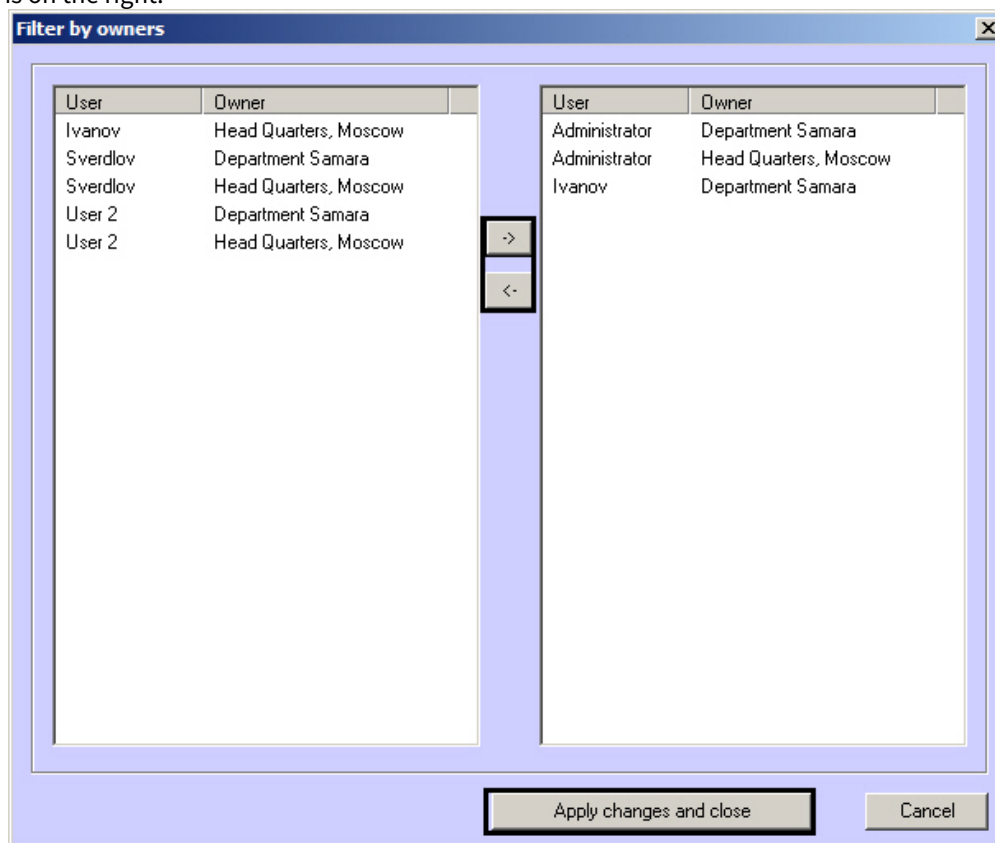
**Note.**

The list of owners is set on the Control Panel – see [Regulatory and reference information](#) section of [Operator's Guide](#).

- c. Users and their rights are configured in the **Users** tab of the **System settings** dialog box – get information on how to do it in the **Intellect Software Package. Administrator's Guide**. The latest version of this document can be found in [AxxonSoft documentation repository](#).
 - d. Move the pairs between the lists using the <- and -> buttons.
 - e. When the list of user-owner pairs is formed, click the **Apply changes and close** button.
14. Selected pairs of users and owners are displayed in the table (13).
 15. Click **Apply** (14).

Configuration of the **Monitoring** interface object is now complete.

When a screen for which the **Monitoring** object has been created is selected in Intellect, the **Monitoring** interface window is displayed.

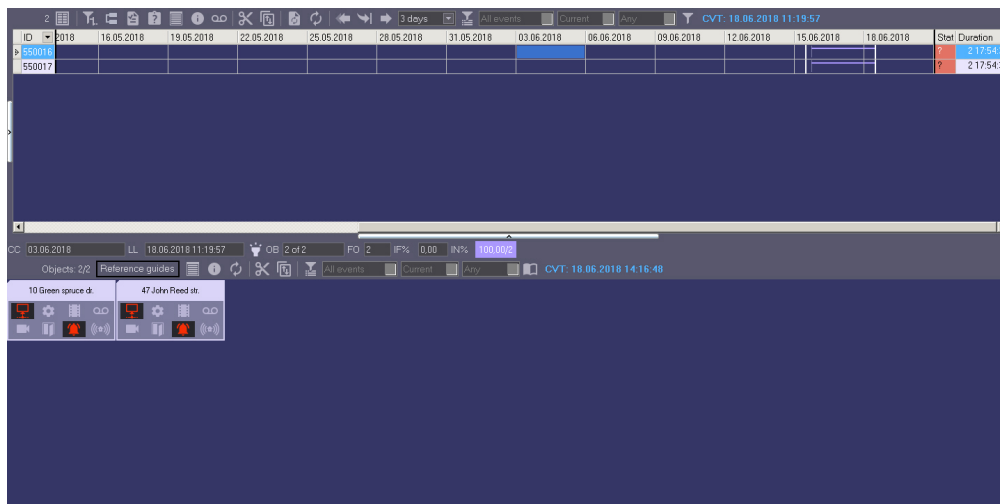

10.3 Configuration of the Search in archive object

By configuring the **Search in archive** interface object, you can indicate the coordinates at which it is displayed on the screen and set up a filter by owners.

Note. The filter by owners is configured similar to **Monitoring** object – see [Configuring the Monitoring interface object](#)

Configuration panel for the **Search in archive** object.

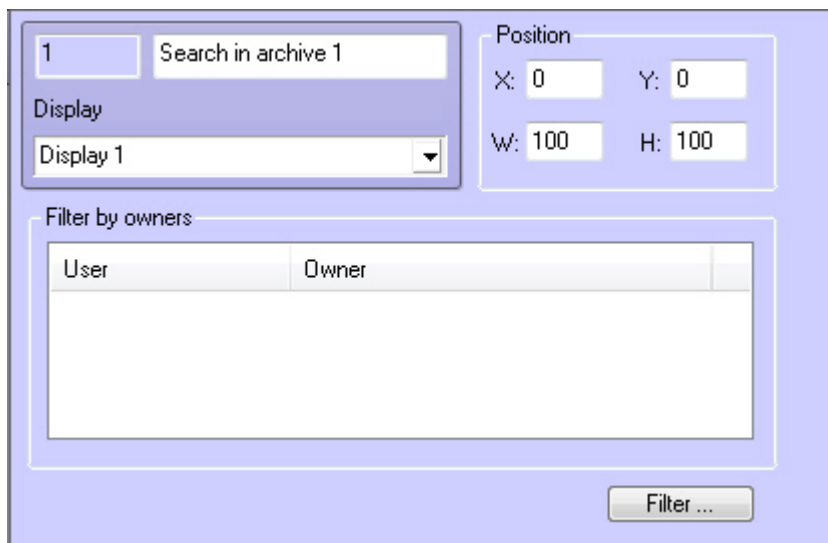

When a display used to create the **Search in archive** object is selected in *Intellect*, the **Search in archive** interface window is visualized.

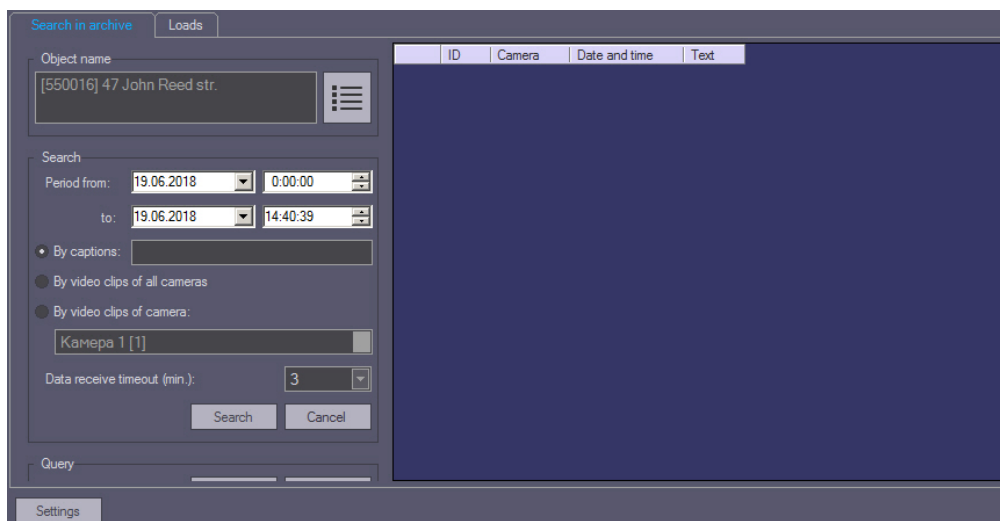

10.4 Configuration of the Monitoring Reports object

To configure the **Monitoring Reports** object, proceed as follows:

1. Select the **Monitoring Reports** object in the object tree. The settings panel of the object is displayed on the right as the **System settings** dialog box.

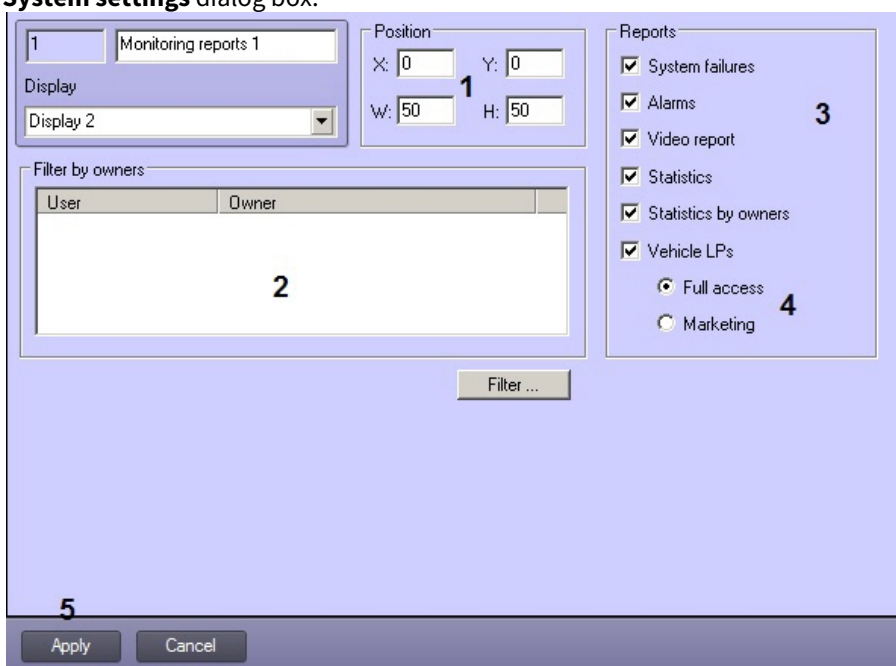

2. Set coordinates for the **Monitoring Reports** interface window (1).
3. Set owners filter similar to the one for the **Monitoring** object (2, see [Configuring the Monitoring interface object](#)).
4. By default, all reports are available for operator. To hide some of the reports, uncheck the boxes next to them in the **Reports** group (3).
5. Select the type of access to the Vehicle LPs reports (4):
 - a. **Full access:** all Vehicle LPs report types are available.
 - b. **Marketing:** only the average time span at the gas station and number of vehicles reports are available, and the Vehicle LP field is restricted to three letters and % symbol.
6. Click **Apply** (5).

Configuration of the **Monitoring Reports** object is completed.

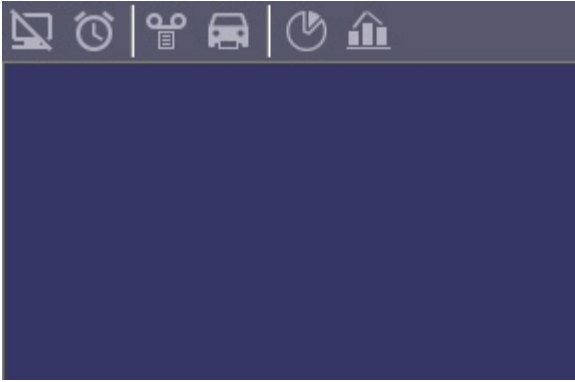

11 Configuring special operation mode joint with Auto Intellect

11.1 Configuration at Agent of Control

Configure special operation mode on *Agent of Control* as follows:

1. Create and configure **Agent of Control** object on the **Hardware** tab (see [Configuring Agent of Control](#)).
2. Create and configure **LPR channel** object on the Hardware tab (see [Auto Intellect. Administrator's Guide](#)).

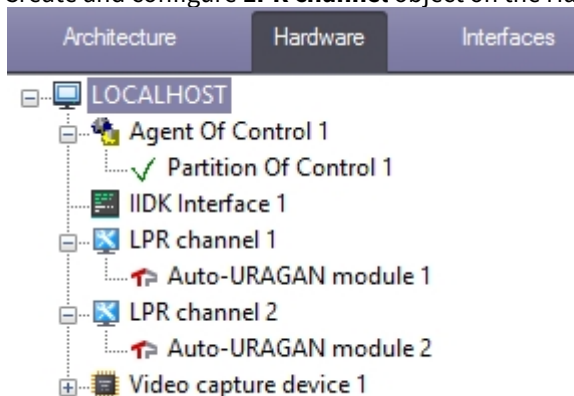

3. Create **Partition of Control** object based on **Agent of Control** object, then add **Number identified** event (see [Configuring the Partition of Control object](#)).

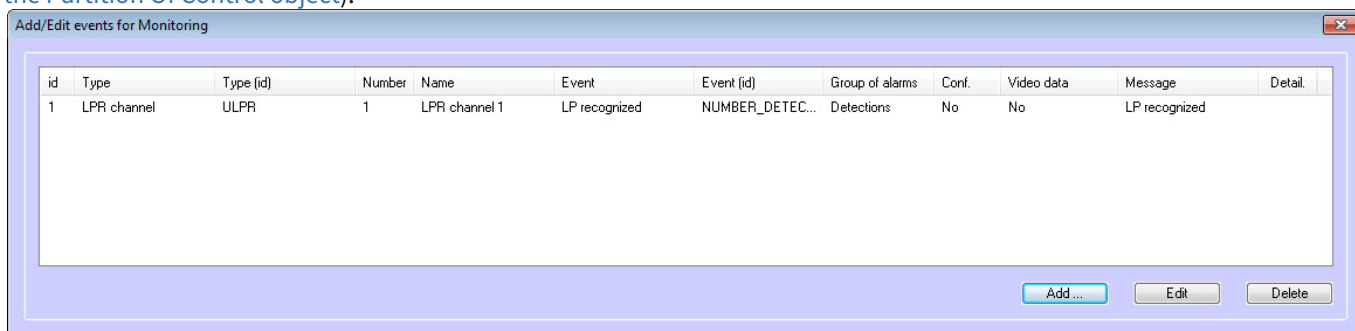

4. Create **ULPR** section in the Windows registry if it is not created yet (see [Registry keys reference guide](#) for more details on the section, see [Working with Windows OS registry](#) for more details on how to operate registry).
5. In the **ULPR** section of the Windows registry create **ULPRspecialProcessing** string parameter and set it to **1** (see [Registry keys reference guide](#) for more details on the key, see [Working with Windows OS registry](#) for more details on how to operate registry).
6. In the **ULPR** section of the Windows registry create **PlaceOfRecognitionN** string parameter, where **N** is the ID of **LPR channel** object. This parameter corresponds to the point of recognition. Value 1 corresponds to entrance; 2, to exit (see [Registry keys reference guide](#) for more details on the key, see [Working with Windows OS registry](#) for more details on how to operate registry).



7. In the **ULPR** section of the Windows registry (see step 4) create **CamOfRecognitionN** string parameter, where **N** is the ID of **LPR channel** object. The value in this key should correspond to the ID of a Camera object specified in the LPR channel object settings (see [Registry keys reference guide](#) for more details on the key, see [Working with Windows OS registry](#) for

more details on how to operate registry).



- Restart the computer to apply changes.

Configuring special operation mode on *Agent of Control* is now completed.

11.2 Configuration at Server of Control

Configure special operation mode on *Server of Control* as follows:

- Create and configure **Server of Control** object on the **Hardware** tab (see [Configuring Server of Control](#)).
- Create and configure one or several **External plates DB** objects on the **Hardware** tab (see [Connecting and setting up of the external LP number database](#)).
- Create and configure **Monitoring** object on the **Interfaces** tab (see [Configuring the Monitoring interface object](#)).

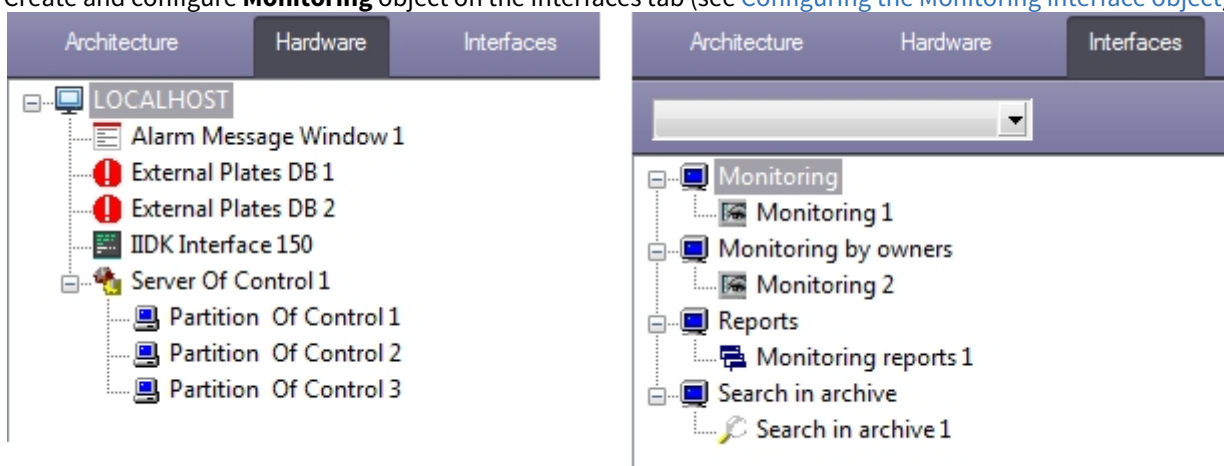

- Create **ULPR** section in the Windows registry if it is not created yet (see [Registry keys reference guide](#) for more details on the key, see [Working with Windows OS registry](#) for more details on how to operate registry).
- In the **ULPR** section of the Windows registry create **ULPRspecialProcessing** string parameter and set it to **1** (see [Registry keys reference guide](#) for more details on the key, see [Working with Windows OS registry](#) for more details on how to operate registry).
- Restart the computer to apply changes.

As a result, the **Info on vehicle license plates** button becomes available in the **Log panel** and **Details** window of the **Monitoring** interface. The **License plate search** window opens when clicking this button (see [Viewing recognized LPs](#)).

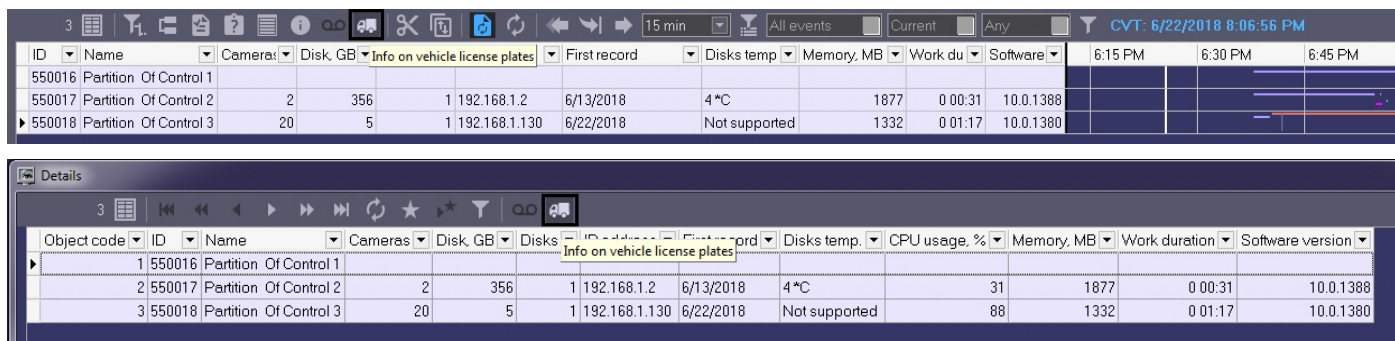

Note.

By default, the **LP found in the database** alarm is generated for **Entrance** recognition point only. In order to generate alarm both on **Entrance** and **Exit** points, in the **ULPR** section of the Windows registry create **AlarmMsgOne** string parameter and set it to **0** (see [Registry keys reference guide](#) for more details on the key, see [Working with Windows OS registry](#) for more details on how to operate registry).

Configuring special operation mode on *Server of Control* is now completed.

12 Appendix 1. Interfaces

12.1 Settings panel of the Agent of Control object

Settings panel of the **Agent of Control** object is given on figure.



Description of the **Agent of Control** object settings panel elements is given in table.

#	Parameter	Method for setting the parameter value	Description	Type	Default value	Value range
1	Identifier	Automatically	Shows the identification number of the Agent of Control object in the system	Nonnegative integer	-	≥ 0
2	Name	Enter the value in the field	Shows the name of the Agent of Control object in the system	Latin, Cyrillic letters and service characters	Agent of Control	A line representing a sequence of any symbols (letters, digits, service characters apart from > and < symbols), not case-sensitive. Number of symbols – from 1 to 60.
3	Computer	Is selected in the list	Assigns the parent Computer object for the Agent of Control object	Name of the Computer objects registered in the system.	Name of the parent Computer object	Depends on the number of the Computer objects in the system.
4	IIDK interface	Enter the value in the field	Sets the ID number of IIDK interface object used by the Agent of Control	Nonnegative integer	150	≥ 0
5	Logging subsystem...	Click the button	Opens a dialog box for setting logging subsystem parameters	-	-	-
6	Restart	Click the button	VideoSrv communication module restarting	-	-	-

12.2 Settings panel of the Partition of Control object

Settings panel of the **Partition of Control** object is given on figure.

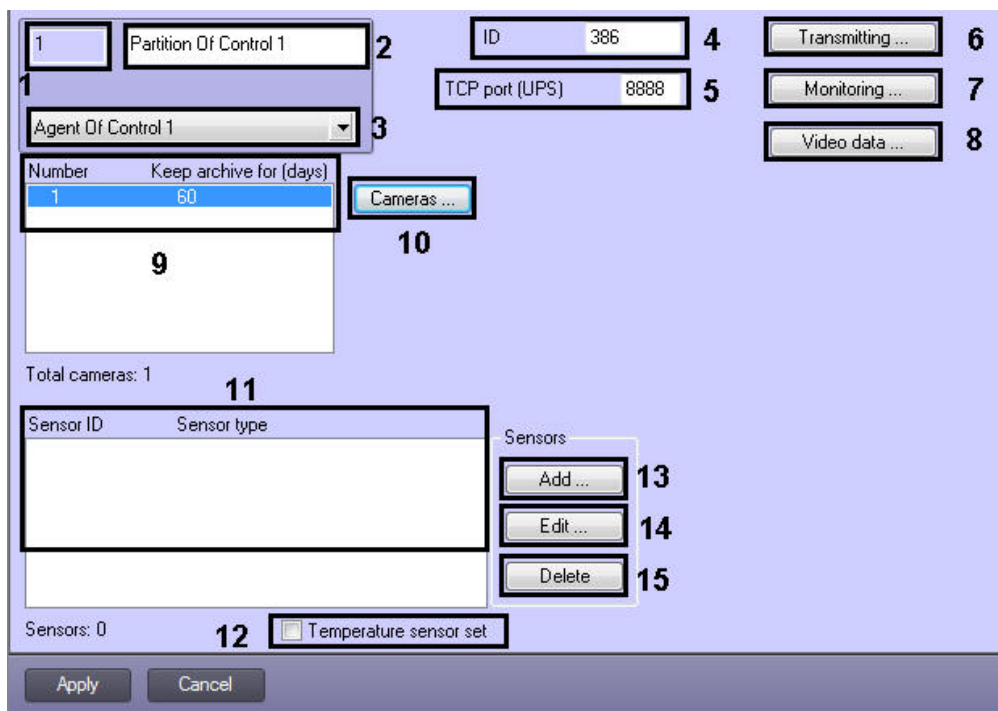

Description of the **Partition of Control** object settings panel elements is given in table.

#	Name	Method for setting the parameter value	Description	Type	Default value	Value range
1	Identifier	Automatically	Shows the identification number of the Partition of Control object in the system	Nonnegative integer	-	Depends on number of Partition of Control objects in the system
2	Name	Enter the value in the field	Shows the name of the Partition of Control object in the system	Latin, Cyrillic letters and service characters	Partition of Control	A line representing a sequence of any symbols (letters, digits, service characters apart from > and < symbols), not case-sensitive. Number of symbols – from 1 to 60.
3	Agent of Control	Is selected in the list	Assigns the parent Agent of Control object for the Partition of Control object	Names of Agent of Control objects registered in the system	Name of the parent Agent of Control object	Depends on the number of the Agent of Control objects in the system.
4	ID	Enter the value in the field	Sets the unique ID number for the object where <i>Agent of Control</i> is installed	Nonnegative integer	386	>=0
5	TCP port (UPS)	Enter the value in the field	Sets the port on which to "listen" for UPS messages	Nonnegative integer	8888	from 1 to 65535

#	Name	Method for setting the parameter value	Description	Type	Default value	Value range
6	Transmitting...	Click the button	Opens a dialog box with settings for configuring the communication method between <i>Agent of Control</i> and <i>Server of Control</i>	-	-	-
7	Monitoring...	Click the button	Opens a dialog box for configuring alarm groups	-	-	-
8	Video data...	Click the button	Opens a dialog box for setting video data transferring configurations	-	-	-
9	Cameras	Using the Cameras... button	Displays the list of cameras whose state and archives are monitored by <i>Agent of Control</i> and operating with which shall be available from <i>Monitoring</i> software interface.	-	-	-
10	Cameras...	Click the button	Opens a dialog box for adding cameras for monitoring	-	-	-
11	Sensors	Using the Add, Edit and Delete buttons	Displays IDs and types of sensors whose state is monitored by <i>Agent of Control</i> and on whose triggering video data are sent to the Server of Control.	-	-	-
12	Temperature sensor set	Is set in a checkbox	Specifies if monitoring to ensure that temperatures do not deviate from an allowed range is performed using temperature sensors	Boolean	False	True – temperature sensors set is in use False – temperature sensors set is not in use
13	Add...	Click the button	Opens a dialog box for adding a sensor. In this dialog box one can also setup video data sending on the sensor triggering	-	-	-
14	Edit...	Click the button	Opens a dialog box for editing the sensor. This dialog box is similar to the one for adding a sensor	-	-	-

#	Name	Method for setting the parameter value	Description	Type	Default value	Value range
15	Delete	Click the button	Deletes sensor from the list	-	-	-

12.3 Settings panel of the Server of Control object

Settings panel of the **Server of Control** object is given on figure.

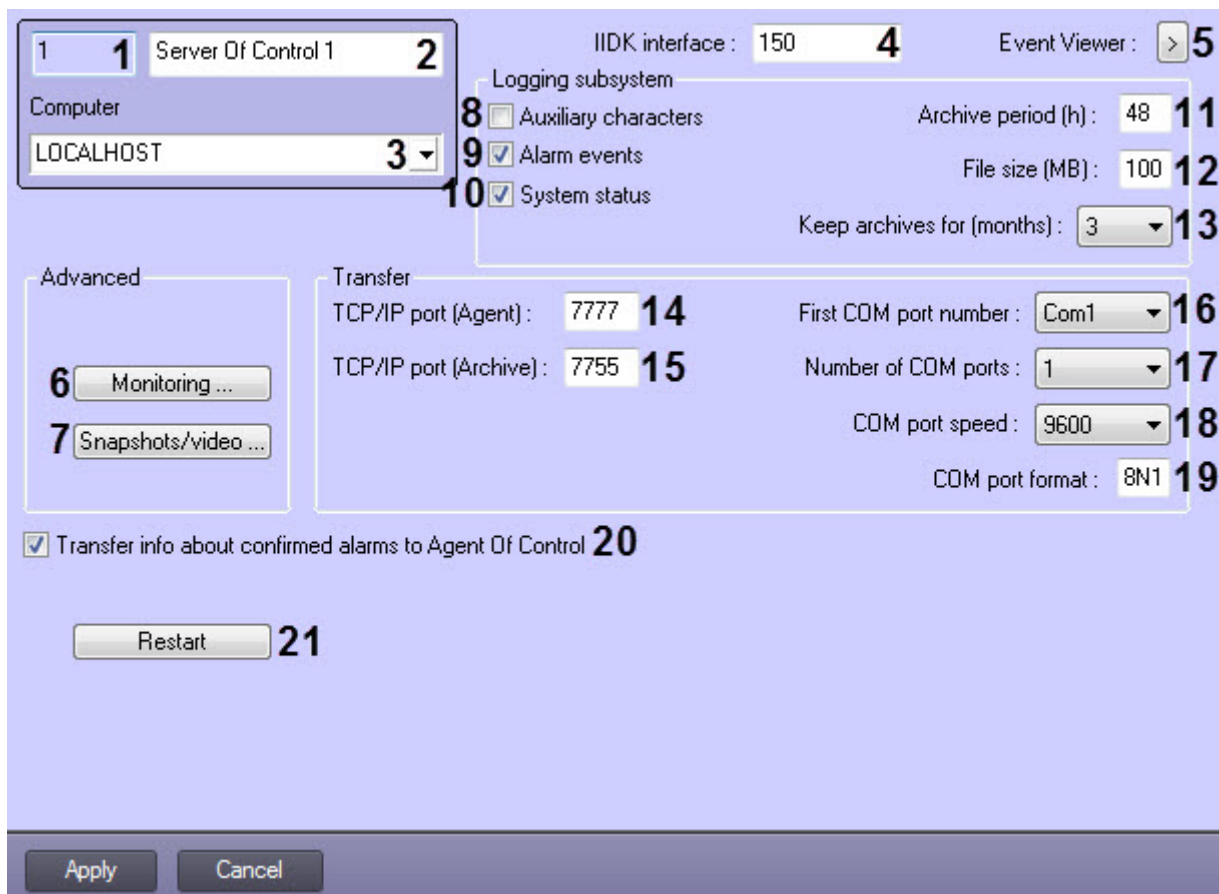

Description of the **Server of Control** object settings panel elements is given in table.

#	Name	Method for setting the parameter value	Description	Type	Default value	Value range
1	Identifier	Automatically	Shows the identification number of the Server of Control object in the system	Nonnegative integer	-	>=0
2	Name	Enter the value in the field	Shows the name of the Server of Control object in the system	Latin, Cyrillic letters and service characters	Server of Control	A line representing a sequence of any symbols (letters, digits, service characters apart from > and < symbols), not case-sensitive. Number of symbols – from 1 to 60.

#	Name	Method for setting the parameter value	Description	Type	Default value	Value range
3	Computer	Is selected in the list	Assigns the parent Computer object for the Server of Control object	Name of the Computer objects registered in the system.	Name of the parent Computer object	Depends on the number of the Computer objects in the system.
4	IIDK interface	Enter a value in the field	Sets the ID of the IIDK interface object used by the <i>Server of Control</i>	Nonnegative integer	150	>=0
5	Event Viewer	Click the button	Opens the Event Viewer tool	-	-	-
Advanced group						
6	Monitoring...	Click the button	Opens the box of setting the list of additional workplaces			
7	Snapshots/video...	Click the button	Opens a dialog box for configuring reaction to snapshots and videos receiving on sensors alarms at the <i>Agent of Control</i>	-	-	-
Logging subsystem group						
8	Auxiliary characters	Is set in a checkbox	Enables logging of auxiliary characters at the transport level into the event log	Boolean	False	True – logging of auxiliary characters is enabled False – logging of auxiliary characters is not performed
9	Alarms	Is set in a checkbox	Enables logging alarms into the event log	Boolean	True	True – logging of alarms is enabled False – logging of alarms is not performed
10	System status	Is set in a checkbox	Enables logging of events related to system status	Boolean	True	True – logging of events related to system status is enabled False – logging of events related to system status is not performed
11	Archive period (h)	Enter the value in the field	Sets the frequency at which the log file is to be archived	Hours	48	>0
12	File size (MB)	Enter the value in the field	Sets the file size threshold upon which the log file is archived. This setting overrides the value in the Archive frequency field.	Megabytes	100	>0
13	Keep archives for (months)	Enter the value in the field	Sets the length of time for which you want to store archived log files.	Months	3	from 1 to 24
Transfer group						

#	Name	Method for setting the parameter value	Description	Type	Default value	Value range
14	TCP/IP port (Agent)	Enter the value in the field	Sets the port number for TCP/IP communication with remote objects of Agent of Control	Nonnegative integer	7777	from 1 to 65535
15	TCP/IP port (Archive)	Enter the value in the field	Sets the port number for TCP/IP communication with remote <i>Search in archive</i> module	Nonnegative integer	7755	from 1 to 65535
16	First COM port number	Is selected in the list	Sets the first COM port number	COM-ports names	Com1	from Com1 to Com256
17	Number of COM ports	Is selected in the list	Sets number of COM ports used	Nonnegative integer	1	from 1 to 256
18	COM port speed	Is selected in the list	Sets the COM port speed	Baud	9600	110 300 1200 2400 4800 9600 19200 38400 57600
19	COM port format	Enter the value in the field	Sets the COM port format	COM port format	8N1	<ul style="list-style-type: none"> • first digit: from 5 to 9 data bits; • second letter: N (No parity) - no parity bit, E (Even parity) - even parity bit, O (Odd parity) - odd parity bit; • third digit: 1 or 2 stop bits.
Outside the groups						
20	Transfer info about accepted alarms to Agent of Control	Set the checkbox	Enables sending confirmations of alarm acceptance by the operator on the <i>Server of Control</i> to the <i>Agent of Control</i> .	Boolean type	Yes	True – confirmations of alarm acceptance are sent. False – confirmations of alarm acceptance are not sent
21	Restart	Click the button	<i>VideoSrv</i> communication module restarting	-	-	-

12.4 Settings panel of the Monitoring interface object

Settings panel of the **Monitoring** interface object is given on figure.

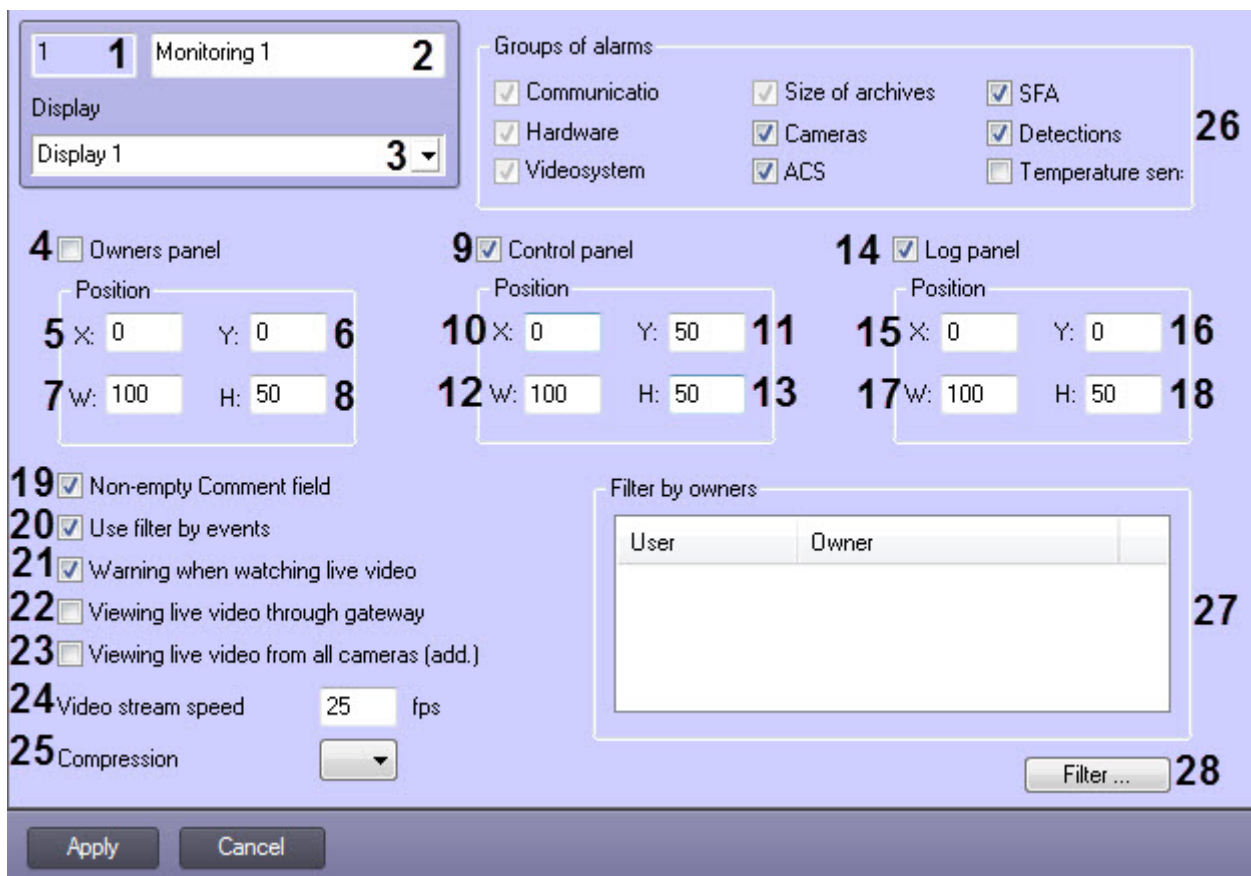

Description of the **Monitoring** object settings panel elements is given in table.

#	Name	Method for setting the parameter value	Description	Type	Default value	Value range
1	Identifier	Automatically	Shows the identification number of the Monitoring object in the system	Nonnegative integer	-	>=0
2	Name	Enter the value in the field	Shows the name of the Monitoring object in the system	Latin, Cyrillic letters and service characters	Monitoring	A line representing a sequence of any symbols (letters, digits, service characters apart from > and < symbols), not case-sensitive. Number of symbols – from 1 to 60.
3	Display	Is selected in the list	Assigns the parent Display object for the Monitoring object	Names of Display objects registered in the system	Name of the parent Display object	Depends on the number of the Display objects in the system.
4	Owners panel	Is set in a checkbox	Enables Owners panel displaying	Boolean	True	True - Owners panel is displayed False - Owners panel is hidden

#	Name	Method for setting the parameter value	Description	Type	Default value	Value range
5	X:	Enter the value in the field	Set the X coordinate in the horizontal axis for the upper-left corner of the Owners panel interface box	% of the screen width	0	from 0 to 100. When more than one monitor is connected to the computer it is possible to use coordinates outside this range, but it is not recommended to use coordinates less than -200.
6	Y:	Enter the value in the field	Set the Y coordinate in the vertical axis for the upper-left corner of the Owners panel interface box	% of the screen width	50	from 0 to 100. When more than one monitor is connected to the computer it is possible to use coordinates outside this range, but it is not recommended to use coordinates less than -200.
7	W:	Enter the value in the field	Set the width of the Owners panel interface box	% of the screen width	100	from 0 to 100. When more than one monitor is connected to the computer it is possible to use coordinates outside this range, but it is not recommended to use coordinates less than -200.
8	H:	Enter the value in the field	Set the height of the Owners panel interface box	% of the screen width	50	from 0 to 100. When more than one monitor is connected to the computer it is possible to use coordinates outside this range, but it is not recommended to use coordinates less than -200.
9	Control panel	Is set in a checkbox	Enables Control panel displaying	Boolean	True	True - Control panel is displayed False - Control panel is hidden
10	X:	Enter the value in the field	Set the X coordinate in the horizontal axis for the upper-left corner of the Control panel interface box	% of the screen width	0	from 0 to 100. When more than one monitor is connected to the computer it is possible to use coordinates outside this range, but it is not recommended to use coordinates less than -200.

#	Name	Method for setting the parameter value	Description	Type	Default value	Value range
11	Y:	Enter the value in the field	Set the Y coordinate in the vertical axis for the upper-left corner of the Control panel interface box	% of the screen height	50	from 0 to 100. When more than one monitor is connected to the computer it is possible to use coordinates outside this range, but it is not recommended to use coordinates less than -200.
12	W:	Enter the value in the field	Set the width of the Control panel interface box	% of the screen width	100	from 0 to 100. When more than one monitor is connected to the computer it is possible to use coordinates outside this range, but it is not recommended to use coordinates less than -200.
13	H:	Enter the value in the field	Set the height of the Control panel interface box	% of the screen height	50	from 0 to 100. When more than one monitor is connected to the computer it is possible to use coordinates outside this range, but it is not recommended to use coordinates less than -200.
14	Log panel	Is set in a checkbox	Enables Log panel displaying	Boolean	True	True - Log panel is displayed False - Log panel is hidden
15	X:	Enter the value in the field	Set the X coordinate in the horizontal axis for the upper-left corner of the Log panel interface box	% of the screen width	0	from 0 to 100. When more than one monitor is connected to the computer it is possible to use coordinates outside this range, but it is not recommended to use coordinates less than -200.
16	Y:	Enter the value in the field	Set the Y coordinate in the vertical axis for the upper-left corner of the Log panel interface box	% of the screen height	0	from 0 to 100. When more than one monitor is connected to the computer it is possible to use coordinates outside this range, but it is not recommended to use coordinates less than -200.

#	Name	Method for setting the parameter value	Description	Type	Default value	Value range
17	W:	Enter the value in the field	Set the width of the Log panel interface box	% of the screen width	100	from 0 to 100. When more than one monitor is connected to the computer it is possible to use coordinates outside this range, but it is not recommended to use coordinates less than -200.
18	H:	Enter the value in the field	Set the height of the Log panel interface box	% of the screen width	50	from 0 to 100. When more than one monitor is connected to the computer it is possible to use coordinates outside this range, but it is not recommended to use coordinates less than -200.
19	Non-empty Comment field	Is set in a checkbox	Is set to require that operators leave comments when accepting an alarm to describe the alarm and/or their actions	Boolean	True	True - Comment field shall not be empty on alarm accepting False - alarm accepting can be done without a comment from Operator
20	Use filter by events	Is set in a checkbox	Is set to enable filtering objects by Alarm and Failure events and Connected and Disconnected states. on the Control Panel.	Boolean	True	True – filter can be applied. False – filter cannot be applied.
21	Warning when watching live video	Is set in a checkbox	Is set if when live video is attempted to be viewed from Control Panel it is necessary to display a warning that it can create the critical load per data channel	Boolean	True	True - when live video is attempted to be viewed from Control Panel the warning is displayed False - when live video is attempted to be viewed from Control Panel the video is displayed with no warnings
22	Viewing live video through gateway	Is set in a checkbox	Is set if Agents of Control and Additional workplaces are in different subnets and the <i>Monitoring</i> components are not in a distributed system configuration in <i>Intellect</i> object tree and Data gateway is in use for transmission of live video to <i>Additional workplaces</i>	Boolean	False	True – live video is transferred to the <i>Additional workplaces</i> through the data gateway. False – live video is transferred to the <i>Additional workplaces</i> directly from the <i>Agent of Control</i> .

#	Name	Method for setting the parameter value	Description	Type	Default value	Value range
23	Viewing live video from all cameras (add.)	Is set in a checkbox	Is set if the "All cameras of Partition of Control" item should be added to the object's "Video image playback" context menu on the Control Panel which enables viewing video from all cameras of the selected Partition of Control.	Boolean	False	True – the "All cameras of Partition of Control" item is added to the object's "Video image playback" context menu on the Control Panel. False – there is no "All cameras of Partition of Control" item in the menu.
24	Video stream speed	Enter the value in the field	Sets the frame rate for live or archive video displaying from Control panel. The setting only works for the archive video with CamMonitor.ocx 4.11.0.1766 or later versions.	Frames per second	25	Depnds on the camera features
25	Compression	Select from the list	Sets live video compression rate	Supported compression rates	No	0-5
26	Groups of alarms	Is set in a checkbox	Sets alarms that one want to visualize on the Control panel	Boolean	All checkboxes except the Temperature sensors are set	If checkbox is set next to the group of alarms, then alarm from the corresponding group will be displayed on the Control panel
27	Filter by owners	Via the Filters... button	Displays selected pairs of users and owners	-	-	-
28	Filter...	Click the button	Opens a dialog box to match owners to users	-	-	-

12.5 Settings panel of the Monitoring reports interface object

Settings panel of the **Monitoring reports** interface object is given on figure.

Description of the **Monitoring reports** object settings panel elements is given in table.

#	Name	Method for setting the parameter value	Description	Type	Default value	Value range
1	Identifier	Automatically	Shows the identification number of the Monitoring reports object in the system	Nonnegative integer	-	≥ 0
2	Name	Enter the value in the field	Shows the identification number of the Monitoring reports object in the system	Latin, Cyrillic letters and service characters	Monitoring	A line representing a sequence of any symbols (letters, digits, service characters apart from > and < symbols), not case-sensitive. Number of symbols – from 1 to 60.
3	Display	Is selected in the list	Assigns the parent Display object for the Monitoring reports object	Names of Display objects registered in the system	Name of the parent Display object	Depends on the number of the Display objects in the system.

#	Name	Method for setting the parameter value	Description	Type	Default value	Value range
4	X:	Enter the value in the field	Set the X coordinate in the horizontal axis for the upper-left corner of the Monitoring reports interface box	% of the screen width	0	from 0 to 100. When more than one monitor is connected to the computer it is possible to use coordinates outside this range, but it is not recommended to use coordinates less than -200.
5	Y:	Enter the value in the field	Set the Y coordinate in the vertical axis for the upper-left corner of the Monitoring reports interface box	% of the screen height	50	from 0 to 100. When more than one monitor is connected to the computer it is possible to use coordinates outside this range, but it is not recommended to use coordinates less than -200.
6	W:	Enter the value in the field	Sets width of the Monitoring reports interface box	% of the screen width	100	from 0 to 100. When more than one monitor is connected to the computer it is possible to use coordinates outside this range, but it is not recommended to use coordinates less than -200.
7	H:	Enter the value in the field	Sets height of the Monitoring reports interface box	% of the screen height	50	from 0 to 100. When more than one monitor is connected to the computer it is possible to use coordinates outside this range, but it is not recommended to use coordinates less than -200.
8	Filter by owners	Via the Filter... button	Displays selected pairs of users and owners	-	-	-
9	Filter...	Click the button	Opens a dialog box to match owners to users	-	-	-
10	Reports	Set the checkbox	Select reports available in the interface window.	Boolean	All checkboxes are set, full access to the Vehicle PLs report is set	Yes – the report button is displayed in the Monitoring Reports interface window. No – the report button is not displayed in the Monitoring Reports interface window.

12.6 Settings panel of the Search in archive interface object

Settings panel of the **Search in archive** interface object is given on figure.

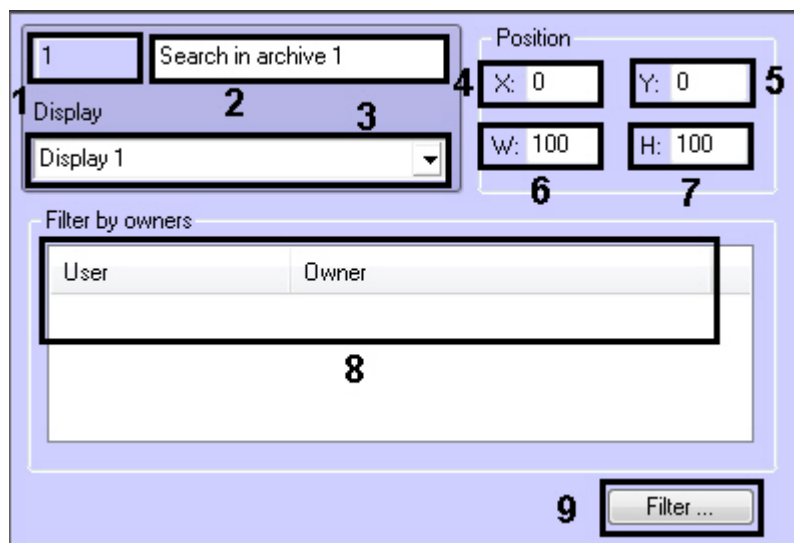

Description of the **Search in archive** object settings panel elements is given in table.

#	Name	Method for setting the parameter value	Description	Type	Default value	Value range
1	Identifier	Automatically	Shows the identification number of the Search in archive object in the system	Nonnegative integer	-	>=0
2	Name	Enter the value in the field	Shows the name of the Search in archive object in the system	Latin, Cyrillic letters and service characters	Monitoring	A line representing a sequence of any symbols (letters, digits, service characters apart from > and < symbols), not case-sensitive. Number of symbols – from 1 to 60.
3	Display	Is selected in the list	Assigns the parent Display object for the Search in archive object	Names of Display objects registered in the system	Name of the parent Display object	Depends on the number of the Display objects in the system.
4	X:	Enter the value in the field	Set the X coordinate in the horizontal axis for the upper-left corner of the Search in archive interface box	% of the screen width	0	from 0 to 100. When more than one monitor is connected to the computer it is possible to use coordinates outside this range, but it is not recommended to use coordinates less than -200.

#	Name	Method for setting the parameter value	Description	Type	Default value	Value range
5	Y:	Enter the value in the field	Set the Y coordinate in the vertical axis for the upper-left corner of the Search in archive interface box	% of the screen height	50	from 0 to 100. When more than one monitor is connected to the computer it is possible to use coordinates outside this range, but it is not recommended to use coordinates less than -200.
6	W:	Enter the value in the field	Sets width of the Search in archive interface box	% of the screen width	100	from 0 to 100. When more than one monitor is connected to the computer it is possible to use coordinates outside this range, but it is not recommended to use coordinates less than -200.
7	H:	Enter the value in the field	Sets height of the Search in archive interface box	% of the screen height	50	from 0 to 100. When more than one monitor is connected to the computer it is possible to use coordinates outside this range, but it is not recommended to use coordinates less than -200.
8	Filter by owners	Via the Filter... button	Displays selected pairs of users and owners	-	-	-
9	Filter...	Click the button	Opens a dialog box to match owners to users	-	-	-

13 Appendix 2. Sample scripts

13.1 Sample script for processing Server of Control command on Agent of Control

In the *Monitoring* software package one can configure ad hoc command sending by the Operator of the *Server of Control* to the *Agent of Control*. Information on how to configure commands on the *Server of Control* can be found in the [Executing ad hoc command on the Agent of Control by the operator of Server of Control](#) section of *Operator's Guide*.

A script for processing incoming commands is to be created on the *Agent of Control*.

Extra menu items are created on the Server of Control – “Arm camera 1” and “Disarm camera 1”. They send a command with parameter 1 or 2 correspondently.

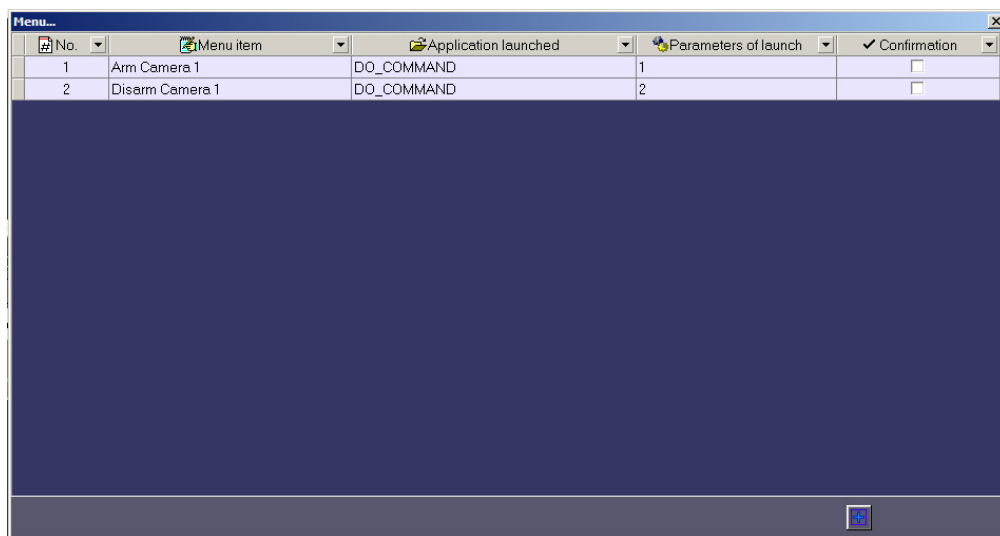

No.	Menu item	Application launched	Parameters of launch	Confirmation
1	Arm Camera 1	DO_COMMAND	1	<input type="checkbox"/>
2	Disarm Camera 1	DO_COMMAND	2	<input type="checkbox"/>

The sample of program in *Intellect* embedded language for processing the incoming command is shown below:

```
OnEvent("VIDEOSRV_C_DVC", "1", "DO_COMMAND")
{
    if (strequal(param0, "1"))
    {
        DoReact("CAM", "1", "ARM");
    }
    if (strequal(param0, "2"))
    {
        DoReact("CAM", "1", "DISARM");
    }
}
```

13.2 Sample script for setting custom filter in the Log Panel

Custom filter on the Log Panel can be changed with a script or macro. For more details on the filter and its configuration in the user interface, see [Custom filter in the Log Panel](#).

Use APPLY_FILTER reaction of the VIDEOSRV_M object to create or change the custom filter in the Log Panel:

```
DoReact("VIDEOSRV_M", "", "APPLY_FILTER", "computer<>, query<>");
```

Parameters:

computer<> – NetBIOS name of the computer to execute the command on.

query<> – filter condition.

The query<>parameter syntax:

query<TotalExpressions;BoolOperatorKind;Expression[;Expression]>

- **TotalExpressions** — number of expressions in the condition
Example:
TotalExpressions = 1 for condition (Cameras equal 2)
TotalExpressions = 3 for condition (Cameras equal 2) and ((Disks equal 1) or (Disks equal 2))
- **BoolOperatorKind** — boolean operator for main expression. Possible values:
– and
– or
Example:
BoolOperatorKind = and for condition (Cameras equal 2)
BoolOperatorKind = and for condition (Cameras equal 2) and ((Disks equal 1) or (Disks equal 2))
BoolOperatorKind = or for condition (Cameras equal 1) or (Cameras equal 2)
- **Expression** — one or several expressions
Format: Field;Expressions;LocalBoolOperator;OperatorKind;Value
 - *Field* — name of the field in the DB table.
Possible values:
 - ID
 - Name
 - Region
 - Province
 - City
 - CamCnt
 - ArcMax
 - HddCnt
 - IpAddress
 - FirstRecord
 - TemperHdd
 - AvailMemory
 - WorkingTime
 - VerSoft
 - *Expressions* — number of expressions in a subcondition.
Example:
Expressions = 1 for condition (Cameras equal 2) and ((Disks equal 1) or (Disks equal 2))
Expressions = 2 for condition (Cameras equal 2) and ((Disks equal 1) or (Disks equal 2))
 - *LocalBoolOperator* — boolean operator for subconditions. Possible values:
– and
– or
Example:
LocalBoolOperator = and for condition (Cameras equal 2)
LocalBoolOperator = or for condition (Cameras equal 2) and ((Disks equal 1) or (Disks equal 2))
 - *OperatorKind* — operator type.
Possible values:
– Equal
– NotEqual
– Less
– LessOrEqual
– Greater
– GreaterOrEqual
– Like
– NotLike
 - *Value* — value to compare with.

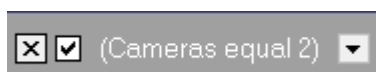
Examples:

```
query<1;and;CamCnt;1;and;Equal;2>
```

With main expressions:

(Cameras less 5) AND (Cameras greater 3) ▼

```
query<2;and;CamCnt;1;and;Less;5;CamCnt;1;and;Greater;3>
```

With subquery:

((Cameras less 5) AND (Cameras greater 3)) ▼

```
query<2;and;CamCnt;2;and;Less;5;CamCnt;2;and;Greater;3>
```

((Cameras greater 1) AND (Cameras less 5)) AND (Disks greater 0) ▼

```
query<3;and;CamCnt;2;and;Greater;1;CamCnt;2;and;Less;5;HddCnt;1;and;Greater;0>
```

(Name ending with 47) ▼

```
query<1;and;Name;1;and;Like;%47>
```

13.3 Sample script for stopping camera recording

If you want for a JPEG still frame to be attached to an alarm message or video fragment when a sensor is activated (**Sensor** object), remember that this is possible only after the current archive file has been written to disk. To reduce the waiting time (the **Delay (sec.)** parameter, see the section [Configuring sensors](#)) and be assured of camera recording, you can create a program on the **Programming** tab of the **System settings** window in Intellect, based on the example below.

The program is written for a camera with an ID of 1 and for a **Sensor** object whose ID is also equal to 1. Thanks to this program, the value of the **Delay** parameter can be set equal to 7 seconds.

```
OnEvent("GRAY","1","ALARM")
{
[
  if( !CheckState("CAM","1","DETACHED") )
  {
    DoReact("CAM","1","REC_ROLLBACK");
    Wait(5);
    DoReact("CAM","1","REC_STOP");
  }
]
}

OnEvent("GRAY","1","ALARM")
{
[
  Wait(2);
  DoReact("GRAY","1","CONFIRM");
  Wait(2);
  DoReact("GRAY","1","ARM");
]
}
```

When continuous recording is in use, the following program should be used:

```

OnEvent("GRAY","1","ALARM")
{
[
Wait(5); // Specifies the time after which the recording should be stopped in order to get the
required clip length or number of frames
DoReact("CAM","1","REC_STOP");
Wait(2); // Pre-alarm record time in the camera settings = 2 sec.
DoReact("CAM","1","REC_ROLLBACK"); // Start recording with pre-alarm recording of 2 seconds.
This allows us not to lose data in the archive
]
}

```

13.4 Sample scripts for processing alarm confirmations

The **Partition of Control** object (VIDEOSRV_C_DVC) sends the «Confirmed: Monitoring events» (CONF_MON) message to *Intellect* core when an alarm is confirmed.

When the confirmation type is **Simple**, then param0<> has the same value as the ID of event that is confirmed (see [Configuring alarm groups](#) section). When **param1<>** is **0**, it means that a Simple confirmation is used.

Below you will find a sample program that can be written on the *Agent of Control* in order to process a received simple confirmation. As a result a camera is armed.

```

OnEvent("VIDEOSRV_C_DVC","1","CONF_MON")
{
  if (strequal(param0,"1"))
  {
    DoReact("CAM","1","ARM");
  }
}

```

When the confirmation type is **Complex**, then param0<> has the value of the ID of event that is confirmed (see [Configuring alarm groups](#) section). If param1<> is **1**, it means that the operator has clicked the **OK** button in the confirm box. If the operator clicked the **Cancel** button, then param1<> would be **2**.

Below you will find a sample program that can be written on the *Agent of Control* in order to process a received complex confirmation. As a result a camera is armed only when the operator clicks the **OK** button in the confirm box.

```

OnEvent("VIDEOSRV_C_DVC","1","CONF_MON")
{
  if (strequal(param0,"1")&&strequal(param1,"1"))
  {
    DoReact("CAM","1","ARM");
  }
}

```

13.5 Sample script to export filtered data from the Log Panel to .xls

Before executing this command, apply filter in the Log Panel. It can be done from the user interface (see [Custom filter in the Log Panel](#)) or by a script (see [Sample script for setting custom filter in the Log Panel](#)).

Export filtered Log Panel data to the test.xls file on disk C:

```
DoReact("VIDEOSRV_M","", "EXPORT_EXCEL", "computer<NamePC>,file<c:\test.xls>");
```

13.6 Sample script to show and hide Search license plates window

Show **Search license plates** window with 70% screen width and 50% screen height in the upper left of the display:

```
DoReact ("VIDEOSRV_M", "", "SHOW_AUTO", "computer<NamePC>,x<0>,y<0>,w<70>,h<50>");
```

Hide **Search license plates** window:

```
DoReact ("VIDEOSRV_M", "", "HIDE_AUTO", "computer<NamePC>");
```

Parameters:

computer<> – name of the computer to execute command on.

x<> – X-axis coordinate of upper left corner the window.

y<> – Y-axis coordinate of upper left corner the window.

w<> – window width as a percentage of the screen width.

h<> – window height as a percentage of the screen height.

14 Configuring the Monitoring fault tolerance

To configure the *Monitoring* fault tolerance, do the following:

1. Configure the main *Server of Control* (see [Configuring Server of Control](#)).
2. Configure the *Agent of Control* (see [Configuring Agent of Control](#)) and set the **Partition of Control** connection to the main *Server of Control* (see [Configuring communication between Agent of Control and Server of Control](#)).
3. Create the second **Partition of Control**, configure in the same way, but with a different **Partition of Control** ID (see [Configuring the Partition Of Control unique ID](#)).
4. Configure a backup *Server of Control* (see [Configuring Server of Control](#)).
5. When configuring the second **Partition of Control**, set the connection parameters to the backup *Server of Control* (see [Configuring communication between Agent of Control and Server of Control](#)).

Attention!

If the list of cameras for tracking was added when configuring the first **Partition of Control** (see [Configuring the camera list](#)), then to add the same cameras to the second **Partition of Control**, it is necessary to change the **MonitoringReserving** key value to **1** in the Windows registry (for details, see [Registry keys reference guide](#), for more information about working with the registry, see [Working with Windows OS registry](#).)

The *Monitoring* fault tolerance is configured.