



Administrator's Guide

Auto Intellect 6.0 (english)

Last update 03/04/2023

Table of contents

1	Administrator's Guide. Introduction	13
1.1	The purpose and structure of this manual	13
1.2	The purpose of the Auto-Intellect software package.....	13
1.3	How to use Auto-Intellect	13
2	Main software and hardware components of the Auto-Intellect system.....	15
2.1	Software	15
2.1.1	Software kernels	15
2.1.2	Functional software modules.....	15
2.1.3	The internal database of the videosever	15
2.1.4	The internal database of the Auto-Intellect software module	15
2.1.5	Software for the workstations.....	16
2.2	Hardware	16
2.2.1	The Guardant hardware protection electronic key	17
2.2.2	Communications environment	17
3	Software and hardware technical requirements	18
3.1	Software and hardware requirements.....	18
3.1.1	General requirements for base computers and operating system	18
3.1.2	Hardware and software requirements for neural analytics.....	18
3.2	Platforms for the software modules of the Auto Intellect system.....	19
3.3	General requirements for mounting and configuring of cameras.....	20
3.3.1	Camera location on the road.....	20
3.3.2	Camera location at the security sites.....	21
3.3.3	Setup of the lens focal length.....	21
3.3.4	Camera setup	21
3.3.5	General parameters of used video cameras	21
4	Installation of Auto-Intellect software components	23
4.1	General description of the Auto Intellect distribution kit	23
4.2	Installation of the Auto Intellect software package	23
4.3	Repairing the Auto Intellect software package	27
4.4	Removing the Auto Intellect software from the computer	29
4.5	Possible problems during installation	31
4.5.1	Intellect software package is installed as a service.....	31

4.5.2	Files that need to be updated by Auto intellect installer are used by another application	32
4.6	Remote installation, deinstallation and update of Auto Intellect	32
4.6.1	Remote installation of Auto Intellect	33
4.6.2	Remote update of Auto Intellect	33
4.6.3	Remote deinstallation of Auto Intellect	34
5	Configuring the Auto-Intellect software package and setting up its components	35
5.1	The configuration and setup procedure of the Auto-Intellect software package	35
5.2	Configuring the program modules.....	36
5.2.1	Activating the software module used for identifying the plates	36
5.2.2	General information on Neural analytics.....	37
5.2.3	Features of Auto Intellect modules operating in VMWare	38
5.2.4	AUTO-Uragan	39
5.2.4.1	The AUTO-Uragan module functionality	39
5.2.4.2	AUTO-Uragan module licensing	41
5.2.4.3	Video camera mounting and setup requirements for the AUTO-Uragan software module	41
5.2.4.4	Setting up the AUTO-Uragan module	42
5.2.4.4.1	Changing the SDK version using batch files	44
5.2.5	Bioiris.....	45
5.2.5.1	The Bioiris module functionality.....	45
5.2.5.2	The Bioiris module licensing	45
5.2.5.3	Video camera mounting and setup requirements for the Bioiris software module	45
5.2.6	CARMEN-Auto	46
5.2.6.1	The CARMEN-Auto module functionality.....	46
5.2.6.2	CARMEN-Auto module licensing	47
5.2.6.3	Video camera mounting and setup requirements for the Carmen software module	47
5.2.6.4	Setting up the CARMEN-Auto module.....	49
5.2.7	CIDR IntelliVision	50
5.2.7.1	The functionality of the CIDR IntelliVision module	50
5.2.7.2	Licensing of the CIDR IntelliVision module	51
5.2.7.3	Video camera mounting and setup requirements for the CIDR IntelliVision module	51
5.2.7.4	Configuring the CIDR IntelliVision module	52
5.2.8	IntLab.....	53
5.2.8.1	The IntLab module functionality.....	53
5.2.8.2	IntLabs module licensing.....	54
5.2.8.3	Video camera mounting and setup requirements for the IntLab module	54

5.2.8.4	Setting up the IntLab module.....	56
5.2.8.4.1	Setting up the auxiliary recognition channel of the IntLab module.....	58
5.2.8.4.2	Setting up display of information on fluid level in search results for the IntLab module	61
5.2.9	LPR IntelliVision	63
5.2.9.1	The LPR IntelliVision module functionality	63
5.2.9.2	LPR IntelliVision module licensing	65
5.2.9.3	Video camera mounting and setup requirements for the LPR IntelliVision software module	65
5.2.9.4	Setting up the LPR IntelliVision module	65
5.2.10	RIDR IntelliVision	67
5.2.10.1	The functionality of the RIDR IntelliVision module	67
5.2.10.2	Licensing of the RIDR IntelliVision module	67
5.2.10.3	Video camera mounting and setup requirements for the RIDR IntelliVision module	67
5.2.10.4	Configuring the RIDR IntelliVision module	69
5.2.11	RoadAR	70
5.2.11.1	The RoadAR module functionality	70
5.2.11.2	RoadAR module licensing.....	71
5.2.11.3	Video camera mounting and setup requirements for the RoadAR software module	72
5.2.11.4	Configuring the RoadAR software module	72
5.2.12	VIT	73
5.2.12.1	The VIT module functionality	73
5.2.12.2	VIT module licensing.....	74
5.2.12.2.1	General information on the VIT module licensing.....	74
5.2.12.2.2	How to activate a Hasp hardware security key for the VIT module.....	75
5.2.12.2.3	How to activate a software demo key for the VIT module	75
5.2.12.2.4	How to activate a software license key for the VIT module	76
5.2.12.3	Video camera mounting and setup requirements for the VIT software module	78
5.2.12.4	Configuring the VIT module.....	79
5.2.13	Taiwan	81
5.2.13.1	The Taiwan module functionality	81
5.2.13.2	Taiwan module licensing.....	81
5.2.13.3	Video camera mounting and setup requirements for the Taiwan software module	82
5.2.14	ARENA	82
5.2.14.1	The ARENA module functionality	82
5.2.14.2	ARENA module licensing.....	82
5.2.14.3	Setting up the ARENA module	82

5.2.15	ARH-Railway	83
5.2.15.1	The ARH-Railway module functionality	83
5.2.15.2	The ARH-Railway module licensing	83
5.2.15.3	Configuring the ARH-Railway module.....	84
5.2.15.4	Requirements for mounting and configuring cameras for carriage recognition.....	87
5.2.15.5	Requirements for mounting and configuring cameras for container recognition	89
5.2.15.6	Combining the carriages and containers SDK.....	92
5.2.15.6.1	Example of a carriage license plate recognition with the aar SDK.....	95
5.2.16	External Plates DB.....	95
5.2.16.1	The External Plates DB module functionality.....	95
5.2.16.2	Connecting and setting up of the external LP number database.....	96
5.2.16.2.1	External database connection and setup procedure.....	96
5.2.16.2.2	Connecting the external database	96
5.2.16.2.3	Assigning names to table columns containing LP numbers.....	101
5.2.16.2.4	Plates search method selection in the external plates database.....	103
5.2.16.2.5	Setting up the number of search results to be displayed	104
5.2.16.2.6	Setting up SQL-query for plates search in the external database	105
5.2.16.2.7	Additional settings of the external plates database	107
5.2.16.3	LP database replication	109
5.2.17	Remote recognition	109
5.2.17.1	The Remote recognition module functionality	109
5.2.17.2	Configuring the cameras with LP recognition and vehicle speed detection	110
5.2.17.2.1	Configuring VEGA Access and VEGA III cameras by Tattile.....	111
5.2.18	Traffic violations detection.....	115
5.2.18.1	Video camera mounting and setup requirements for the Traffic violations detection.....	115
5.2.18.2	The Traffic violations detection functionality	115
5.2.18.3	Setting up the Traffic violations detection module	115
5.2.19	Parking violation detection	121
5.2.19.1	The Parking violation detection functionality.....	121
5.2.19.2	Setting up the Parking violation detection module.....	121
5.2.20	Traffic Detection.....	122
5.2.20.1	The Traffic Detection module functionality.....	122
5.2.20.2	Traffic Detection module licensing	123
5.2.20.3	Video camera mounting and setup requirements for the Traffic Detection module	123
5.2.20.4	The Traffic Detection software module setup	125

5.2.20.4.1	Traffic Detection setup procedure	125
5.2.20.4.2	Selecting the camera to be used by the Traffic Detection	126
5.2.20.4.3	Setting up the database archive depth.....	126
5.2.20.4.4	Setting up the update time and period for displaying statistics	127
5.2.20.4.5	Setting up the road markings parameters.....	128
5.2.20.4.6	Importing and exporting the file with the markings parameters	133
5.2.20.4.7	Setting up the joint operation of Traffic Detection and Speed traps server modules	135
5.2.20.4.8	Setting up the jam detection parameters.....	136
5.2.20.4.9	Setting the driving direction names to be shown in the Traffic Monitor window	137
5.2.20.4.10	Setting up the traffic limiting parameters	138
5.2.20.4.11	Selecting the events to be saved to database and to generate notifications in the Traffic Monitor window	139
5.2.21	Camera of recognition upon request.....	140
5.2.21.1	Setting up the Camera of recognition upon request module.....	140
5.2.22	Vehicle Type Recognition module.....	144
5.2.22.1	The Vehicle Type Recognition Module functionality.....	144
5.2.22.2	Video camera mounting and setup requirements for the Vehicle Type Recognition Module	144
5.2.22.3	Setting up the Vehicle type recognition module	144
5.2.22.4	Saving the frames processed by the Vehicle Type Recognition module.....	145
5.2.23	RoadAR vendor and model recognizer	146
5.2.23.1	The functionality of RoadAR vendor and model recognizer module	146
5.2.23.2	Licensing of the RoadAR vendor and model recognizer module	146
5.2.23.3	Video camera mounting and setup requirements for the RoadAR vendor and model recognizer module.....	147
5.2.23.4	Configuring the RoadAR vendor and model recognizer module.....	147
5.2.24	Information-gathering subsystem	147
5.2.24.1	The Information-gathering subsystem functionality	147
5.2.24.1.1	The IntelliVision vehicle detection functionality	148
5.2.24.1.2	The Vehicle Processor functionality.....	148
5.2.24.2	Video camera mounting and setup requirements for the IntelliVision vehicle detection module.....	148
5.2.24.3	Traffic data gathering subsystem setup	149
5.2.24.3.1	Traffic data gathering subsystem setup procedure	149
5.2.24.3.2	Setting up the IntelliVision vehicle detection parameters.....	149
5.2.24.3.3	Setting up the Vehicle Processor module.....	150
5.2.24.3.3.1	Vehicle Processor setup procedure.....	150
5.2.24.3.3.2	Setting up the Vehicle Processor and IntelliVision vehicle detection modules interaction	150

5.2.24.3.3.3	Selecting the Vehicle Processor operation mode	151
5.2.24.3.3.4	Setting up the vacant lane speed	153
5.2.24.3.3.5	Setting up the vehicles classification according to the length	153
5.2.25	Speed traps server	155
5.2.25.1	The Speed traps server module functionality	155
5.2.25.2	Speed-trap mounting and setup requirements for the Speed traps server module	155
5.2.25.3	The Speed traps server software module setup	155
5.2.25.3.1	The Speed traps server module setup procedure	156
5.2.25.3.2	Setting up the speed-trap device connection to the server	156
5.2.25.3.3	Selecting the video camera for Speed traps server and LPR channel joint operation	156
5.2.25.3.4	Setting up the vehicle speed	157
5.2.25.3.5	Selecting the model and installation type of a Speed-trap device	158
5.2.25.3.6	Selecting the vehicle movement direction and distance	158
5.2.25.3.7	Setting up the Speed-trap device	159
5.2.25.3.8	Specifying the Speed-trap device information to be displayed in the recognized number report	160
5.2.25.4	Joint operation of the LPR channel and Speed traps server modules	161
5.3	Setting up the LPR channel	162
5.3.1	Selecting the video cameras to work with the LPR channel	162
5.3.2	Setting up the video recording parameters	164
5.3.3	Setting up the LP storage and the database records retention period	165
5.3.3.1	Configuring the database records retention period	165
5.3.3.2	Recognized LP images and vehicle images storing modes	166
5.3.3.3	Configuring recognized LP images and vehicle images storage in Auto Intellect database	166
5.3.3.4	Configuring the recognized LP images and vehicle images storage on disk	167
5.3.4	Setting up the LPR channel detector	168
5.3.5	Setting the LP number search area border	171
5.3.6	Selecting the country and license plate recognition SDK	174
5.3.6.1	General information	174
5.3.6.2	Selecting the country for license plate recognition	175
5.3.6.3	Selecting the license plate recognition SDK	176
5.3.7	Setting up the frame sign parameters	177
5.3.8	Setting up the LP recognition results display	184
5.3.9	Setting the joint operation of the LPR channel and the motion detector of the Intellect platform	186
5.3.10	Selecting the traffic direction for LP number recognition	187
5.3.11	Setting up the results filtering	189

5.3.12	Frame processing setup.....	190
5.3.13	Configuring speed estimation by video	191
5.3.14	Settings of LP processing.....	193
5.4	Setting up the joint operation of Auto Intellect and Axxon Next.....	196
5.5	The Traffic Monitor interface object setup	197
5.5.1	The Traffic Monitor setup procedure	197
5.5.2	Setting up the position of the Traffic Monitor window	197
5.5.3	Selecting the traffic detectors to be connected to the Traffic Monitor object	198
5.5.4	Setting up the traffic information display option.....	199
5.5.5	Setting up the Alarm window position	200
5.6	The Vehicle Tracer interface module	200
5.6.1	The Vehicle Tracer functionality.....	200
5.6.2	The Vehicle Tracer setup procedure	201
5.6.3	Setting up the position of the Vehicle Tracer components on the screen	201
5.6.4	LPR channels selection	203
5.6.5	Selecting the External Plates Database	204
5.6.6	Setting up the Vehicle Tracer interface window.....	205
5.6.7	Setting up the audio notification while registering the alarms	207
5.6.8	Selecting the external LPs databases as the Active tracking databases.....	208
5.6.9	Setting up color for LP recognition events	210
5.6.10	Selecting the Monitor object for playing back the video archive	213
5.6.11	Setting up the font of the recognized LP number	214
6	Appendices	216
6.1	Appendix 1. Interface description	216
6.1.1	The LPR channel object settings panel	216
6.1.2	The External Plates DB object settings panel	227
6.1.3	The IntelliVision vehicle detection settings panel.....	230
6.1.4	The Parking violation detection module settings panel.....	230
6.1.5	The Speed traps server object settings panel	231
6.1.6	The Traffic Detection object settings panel.....	233
6.1.7	The Traffic Monitor object settings panel.....	236
6.1.8	TheTraffic violations detection module object settings panel.....	239
6.1.9	The Vehicle processor settings panel.....	241
6.1.10	The Vehicle Tracer object settings panel	243
6.1.11	The ARENA module object settings panel.....	247

6.1.12	The ARH-Railway module object settings panel	249
6.1.13	The AUTO-Uragan module object settings panel.....	252
6.1.14	The CARMEN-Auto module object settings panel	255
6.1.15	The IntLab Module object settings panel.....	256
6.1.16	The IntLab subordinate module object settings panel.....	257
6.1.17	The RoadAR module object settings panel.....	259
6.1.18	The VIT module object settings panel.....	261
6.1.19	The CIDR IntelliVision module object settings panel	264
6.1.20	The RIDR IntelliVision module object settings panel	266
6.1.21	The LPR IntelliVision module object settings panel.....	269
6.2	Appendix 2. Examples of widely used scripts	271
6.2.1	General information about scripts.....	271
6.2.2	Scripts used in the Auto-Intellect software package	271
6.3	Appendix 3. Database replication via MS SQL Server.....	273
6.3.1	Introduction	273
6.3.2	Replication setup	274
6.3.2.1	Replication setup features.....	274
6.3.2.2	Publication setup	274
6.3.2.3	Subscription setup.....	275
6.3.3	Example of setting up the Traffic replication database	276
6.3.3.1	Setting up the replication on the publishing server.....	277
6.3.3.2	Setting up replication on the subscriber server	283
6.4	Appendix 4. Procedures for the Auto-Intellect database and software for fine imposing interaction	290
6.5	Appendix 5. Setting up the External plates database in «dbf» format.	292
6.6	Appendix 6. The Debug windows	296
6.6.1	ULPR server debug window.....	296
6.6.1.1	The launch of the ULPR server debug window	296
6.6.1.2	The ULPR server debug window interface.....	297
6.6.1.3	The operations in the ULPR server debug window	299
6.6.1.3.1	The forced clearing of the license plate numbers database.....	299
6.6.1.3.2	Editing the Nearest Time for the specified remote recognition module	299
6.6.2	UrlServer debug window	301
6.6.2.1	The launch of the UrlServer debug window	301
6.6.2.2	The UrlServer debug window interface	302

6.7	Appendix 7. The utilities description to work with Auto-Intellect software	304
6.7.1	The utilities to work with AUTO-Urgan recognition module	304
6.7.1.1	KeyInfo.exe utility for reading the Urgan keys	304
6.7.1.1.1	General information about the KeyInfo.exe utility.....	304
6.7.1.1.2	Starting and closing the utility	304
6.7.1.1.3	Using the KeyInfo.exe utility.....	304
6.7.1.2	PatCfgr.exe utility for active patterns configuration of Auto-URAGAN module	305
6.7.1.2.1	General information about PatCfgr.exe utility	305
6.7.1.2.2	Starting and closing the PatCfgr.exe utility	305
6.7.1.2.3	Using the PatCfgr.exe utility	306
6.7.1.2.3.1	Open the configuration.....	306
6.7.1.2.3.2	Edit the list of configuration patterns.....	307
6.7.1.3	RTKeyUpdate.exe utility for updating the Urgan keys.....	308
6.7.1.3.1	General information about the RTKeyUpdate.exe utility	308
6.7.1.3.2	Starting and closing the RTKeyUpdate.exe utility	308
6.7.1.3.3	Using the RTKeyUpdate.exe utility	309
6.7.1.3.3.1	Generation the query file for key updating.....	309
6.7.1.3.3.2	Key update by answer received from software vendor	311
6.7.2	The utilities to work with VIT recognition module	312
6.7.2.1	LicenceViewer.exe utility for reading the VIT keys	312
6.7.2.1.1	General information about the LicenceViewer.exe utility	312
6.7.2.1.2	Starting and closing the LicenceViewer.exe utility	312
6.7.2.1.3	Using the LicenceViewer.exe utility	313
6.7.2.2	PresetEditor.exe utility for active patterns configuration of VIT module	314
6.7.2.2.1	General information about PresetEditor.exe utility.....	314
6.7.2.2.2	Starting and closing the PresetEditor.exe utility.....	314
6.7.2.2.3	Using the PresetEditor.exe utility.....	315
6.7.3	LprFsTool.exe utility for loading images of recognized license plates from database to disk	316
6.7.3.1	General information about the LprFsTool.exe utility.....	316
6.7.3.2	Starting and closing the LprFsTool.exe utility.....	316
6.7.3.3	Using the LprFsTool.exe utility.....	317
6.7.4	TestAppTMD.exe utility for setting up the Intellivision vehicle detection	318
6.7.4.1	General information about TestAppTMD.exe utility and its licensing	318
6.7.4.1.1	General information about TestAppTMD.exe utility	318
6.7.4.1.2	Licensing of the TestAppTMD.exe utility.....	318

6.7.4.2	Starting and closing the TestAppTMD.exe utility	318
6.7.4.3	Using the TestAppTMD.exe utility	319
6.7.4.3.1	Opening a video file in TestAppTMD.exe utility	319
6.7.4.3.2	Interface description of Area editor window	322
6.7.4.3.3	Guidelines for creating and configuring the zones in Area editor window	326
6.7.4.3.3.1	General information about creating the zones in Area editor window	326
6.7.4.3.3.2	Examples of correct and incorrect zone configuration	326
6.8	Appendix 8. Auto Intellect. REST API	329
6.8.1	UrlServer	329
6.8.1.1	Initializing UrlServer	329
6.8.1.1.1	General request format:.....	329
6.8.1.1.2	Request parameters:.....	330
6.8.1.1.3	Request example:.....	330
6.8.1.2	Removing the UrlServer instance.....	330
6.8.1.2.1	General request format:.....	330
6.8.1.2.2	Request parameters:.....	330
6.8.1.2.3	Request example:.....	330
6.8.1.3	Unloading UrlServer	331
6.8.1.3.1	General request format:.....	331
6.8.1.3.2	Request example:.....	331
6.8.1.4	UrlServer frame recognition	331
6.8.1.4.1	General request format:.....	331
6.8.1.4.2	Request parameters:.....	331
6.8.1.4.3	Request example:.....	331
6.8.1.4.4	Response example:	335
6.8.1.4.5	Response parameters:	336
6.8.2	ULPR Server	336
6.8.2.1	Image receiving by the ID	336
6.9	Appendix 9. LPR channel integration via TCP/IP	336
6.9.1	TCP port 35555	337
6.9.2	TCP port 55555	337
6.10	Appendix 10. Selea CPS (Car Plate Server) configuration guide	338
6.10.1	Brief description of Selea CPS	338
6.10.2	Configuring the Selea CPS server	338
6.10.3	Configuring the Selea cameras	341

6.10.4	Configuring Intellect to work with the Selea CPS.....	341
6.11	Appendix 11. Examples of correct and incorrect video images for the LPR IntelliVision software module.....	345

1 Administrator's Guide. Introduction

On the page:

- [The purpose and structure of this manual](#)
- [The purpose of the Auto-Intellect software package](#)
- [How to use Auto-Intellect](#)

1.1 The purpose and structure of this manual

The Auto-Intellect Software Package. The Administrator's Guide document is intended to be used as a reference by videocamera, radar and other devices installation and setup specialists, and administrator users of the *Auto-Intellect* software responded for connection of program modules and their configuration.

This manual includes the following:

1. General description of the *Auto-Intellect* software.
2. Main software and hardware components of *Auto-Intellect*.
3. Technical requirements for the software and hardware platform.
4. Personnel qualification requirements.
5. Installing the components of *Auto-Intellect*.
6. Configuring *Auto-Intellect* and setting of its components.
7. Appendix 1. Description of the interfaces.
8. Appendix 2. Examples of high-usage scripts.
9. Appendix 3. Procedures for the *Auto-Intellect* database and software for fine imposing interaction.
10. Appendix 4. Database replication via MS SQL Server .
11. Appendix 5. Setting up the External plates database in «dbf» format.
12. Appendix 6. The utilities description to work with *Auto-Intellect* software.

1.2 The purpose of the Auto-Intellect software package

The *Auto-Intellect* software package was designed for automated traffic monitoring including the following functionality:

1. License plate recognition.
2. Matching the recognized license plate numbers with the numbers in the *Auto-Intellect* database.
3. Determining the speed of the vehicles.
4. Determining general parameters of traffic as a whole and determining traffic characteristics of each particular vehicle.
5. Centralized event registration and processing, as well as notification and action generation according to flexible algorithms.
6. Photo and video archive building.
7. The scalability of the software package.

1.3 How to use Auto-Intellect

The *Auto-Intellect* software package is installed as an extension for the Intellect software package.

To operate the software properly, please, follow these recommendations:

1. Fulfill your job description accurately.
2. Use the software for the intended purpose.

3. Do not use the computer with Intellect installed, to run other software which is not part of the Intellect package.

It is not recommended to use the same logical disk for recording the *Intellect* (basic) video archive as for storage of the *Auto-Intellect* database. It can cause the data loss. Detailed information about setting up the disks for recording the Intellect video archive is given in [Intellect Software Package.Administrator's Guide document](#).

2 Main software and hardware components of the Auto-Intellect system

2.1 Software

2.1.1 Software kernels

Auto-Intellect is delivered in the following configuration versions:

1. Based on the full-scale Intellect software kernel (the `intellect.exe` software module). The full-scale software kernel supports the videosever, administration workstation and operator workstation functionality.
2. Based on the reduced software kernel (the `slave.exe` software module). The reduced kernel supports the operator workstation functionality only.

The operator workstation software does not support system administration functions (object creation, deletion or setup, user registration, user rights management), as well as local database maintenance. The operator workstation module uses the remote database owned by the videosever or the administration workstation and controlled by the `intellect.exe` kernel.

The `intellect.exe` full-scale executable module is used as the main software component. Other functional modules comprise the subsystems and interact with the main system kernel.

The distributed surveillance system is integrated using the interaction of the software kernels.

2.1.2 Functional software modules

The functional software modules are responsible for actual interaction with the hardware and produce the data about the status of the controlled objects. The kernel processes the information received from the software modules and integrates them.

The list of available functional modules depends on the delivery configuration of the system. The executables of the functional subsystems are launched automatically by the kernel during the system configuration.

For example, if a **Video camera** object is created, the `video.run` subsystem executable is launched immediately after the corresponding settings are configured.

2.1.3 The internal database of the videosever

The videosever internal database contains the following information:

1. system settings (information about the objects created in the system, their properties, the users and user rights, and other data);
2. events registered by the system (event logs) during the time period set in the configuration.

The internal database of the server has the MS SQL format. The MS SQL Server 2014 is supported in *Auto-Intellect* software.

The object data, the settings of the surveillance systems and the event logs may be automatically replicated from a videosever or administration workstation to all databases of other videosevers and administrator workstations in the system. The full-scale Intellect kernels communicate with each other using the TCP/IP protocol (if such communication is enabled during the system configuration).

The object information is initially saved in the database of the videosever or administration workstation which owns the corresponding objects. The information is automatically replicated when the data changes, the kernel is launched or the connection restored.

The replication is used to maintain common event space across the distributed surveillance system.

The replication process is hidden from the user.

2.1.4 The internal database of the Auto-Intellect software module

The *Auto-Intellect* module internal database contains the following information:

1. the settings of the system objects;
2. events registered by the system (event logs) during the time period set in the configuration.

The internal database of the *Auto-Intellect* module has the MS SQL format. The free MS SQL Express version is used. The technical characteristics and the limitations of the free version can be found on the vendor's site (see <http://www.microsoft.com>).

Note.

The *Auto-Intellect* software requires permanent connection to the MS SQL Server (see the [Intellect Software Package Administrator's Guide](#) document).

A commercial version of MS SQL Server can be used to overcome the limitations of the free version of Microsoft SQL Server 2014 Express Edition.

See the site of the vendor to learn about the versions of Microsoft SQL Server 2014 ([https://msdn.microsoft.com/en-us/library/cc645993\(v=sql.120\).aspx](https://msdn.microsoft.com/en-us/library/cc645993(v=sql.120).aspx)).

2.1.5 Software for the workstations

The digital video surveillance system based on the *Auto-Intellect* software package can include the following workstation types based on the Intellect platform:

1. Operator workstation;
2. Administration workstation;

The *AutoIntellect.msi* executable module should be installed on the main computer in order to support the operation of *Auto-Intellect* on workstations.

To enable remote operation of *Auto-Intellect*, the *Guardant* hardware protection key should be installed on the main computer. The key is included in the *Auto-Intellect* delivery set. The computer with the administration workstation software installed also supports the operator workstation functionality in case the user logs in using the operator password. If no hardware protection key is installed, the *Auto-Intellect* software can be used in its demo version only.

2.2 Hardware

On the page:

- [The Guardant hardware protection electronic key](#)
- [Communications environment](#)

The following hardware and software components can be included in the video surveillance system based on the *Auto-Intellect* package:

1. The operator and administration workstations using IBM-compatible personal computers. Administration workstation functionality includes the operator workstation functionality;
2. Videoservers using IBM-compatible personal computers with specialized hardware installed (audio and video capture cards, USB audio input devices). Videoserver functionality includes the functionality of both workstation types;
3. Administration workstations enabled for videoserver functionality using the network (IP) audio and video capture devices;
4. Network video concentrators (WaveHub, LinuxHub, etc);
5. Network videoservers (Matrix, etc);
6. Analog and IP video cameras;
7. Speed-traps;
8. TCP/IP communications environment.

2.2.1 The Guardant hardware protection electronic key

The *Auto-Intellect* software package is protected. To install *Auto-Intellect* on the main computer, the *Guardant* electronic key for hardware protection must be present.

2.2.2 Communications environment

The communications hardware of the *Auto-Intellect* software package allows creation of automated monitoring systems for spacious and highly diverse sites. The components of the system communicate with each other automatically and form an integrated security system.

Local networks (LAN), the Internet (WAN), telephone lines (dial-up) and dedicated lines are used for data exchange and communications between system components using the TCP/IP protocol.

3 Software and hardware technical requirements

3.1 Software and hardware requirements

On this page:

- [General requirements for base computers and operating system](#)
- [Hardware and software requirements for neural analytics](#)

3.1.1 General requirements for base computers and operating system

The requirements for the base computers and operating system for *Auto Intellect* correspond to the same requirements for the *Intellect* (see [Intellect Administrator's Guide](#)).

3.1.2 Hardware and software requirements for neural analytics

The software modules that use neural analytics (see [General information on Neural analytics](#)) have the following software and hardware platform requirements:

1. Due to the NVIDIA SDK specific features, the neural analytics can operate only on Windows Server 2019 OS and Windows 10 OS.
2. The neural network analytics supports the following devices: CPU, GPU NVIDIA, VPU ([Intel NCS](#), [Intel HDDL](#)).
3. If CPU or Intel GPU is used for the neural network analytics operation, then the following requirements should be taken into account:
 - a. support for Intel CPUs from 6th generation (Skylake) and Intel Pentium® processors N4200/5, N3350/5 or N3450/5 with Intel® HD Graphics
 - b. the OpenVino toolkit should support the Intel CPU being used (for more information see <https://software.intel.com/content/www/us/en/develop/tools/openvino-toolkit/system-requirements.html>).
4. NVIDIA GeForce 1050 Ti GPU or newer. GPU requirements:
 - a. at least 2 GB of memory;
 - b. Compute Capability 3.0 or higher.



Note.

Please check the GPU's Compute Capability version on the [manufacturer's web site](#).



Attention!

When using NVIDIA graphics cards, it is recommended to install the latest driver from the NVIDIA [official web site](#).

A single neural network consumes 500 MB of video memory. You can use multiple video cards in your system.

Attention!

To ensure the correct operation of each software module that uses neural analytics, the video image requirements should also be met (see [Configuring the program modules](#)).

3.2 Platforms for the software modules of the Auto Intellect system

Auto Intellect includes the following basic software modules, operating on the following platforms:

Module	x32	x64
ARENA module	<input type="checkbox"/>	<input type="checkbox"/>
ARH-Railway module	<input type="checkbox"/>	<input type="checkbox"/>
AUTO-Uragan module	<input type="checkbox"/>	<input type="checkbox"/>
Bioiris module	<input type="checkbox"/>	<input type="checkbox"/>
CARMEN-Auto module	<input type="checkbox"/>	<input type="checkbox"/>
CIDR IntelliVision module	<input type="checkbox"/>	<input type="checkbox"/>
IntLab module	<input type="checkbox"/>	<input type="checkbox"/>
LPR IntelliVision module	<input type="checkbox"/>	<input type="checkbox"/>
RIDR IntelliVision module	<input type="checkbox"/>	<input type="checkbox"/>
RoadAR module	<input type="checkbox"/>	<input type="checkbox"/>
Taiwan module	<input type="checkbox"/>	<input type="checkbox"/>
VIT module	<input type="checkbox"/>	<input type="checkbox"/>

Additionally, the software package includes:

Module	x32	x64
External Plates DB	<input type="checkbox"/>	<input type="checkbox"/>
IntelliVision vehicle detection	<input type="checkbox"/>	<input type="checkbox"/>
Parking violation detection	<input type="checkbox"/>	<input type="checkbox"/>
Remote recognition	<input type="checkbox"/>	<input type="checkbox"/>
Speed traps server module	<input type="checkbox"/>	<input type="checkbox"/>
Traffic Detection	<input type="checkbox"/>	<input type="checkbox"/>
Traffic Monitor	<input type="checkbox"/>	<input type="checkbox"/>
Traffic violations detection	<input type="checkbox"/>	<input type="checkbox"/>

Module	x32	x64
Vehicle Processor	<input type="checkbox"/>	<input type="checkbox"/>
Vehicle Tracer	<input type="checkbox"/>	<input type="checkbox"/>
Vehicle type recognition module	<input type="checkbox"/>	<input type="checkbox"/>

⚠ Attention!
 To enable the 64-bits modules, set the **Run x64 modules** checkbox in *Intellect*. However, simultaneous operation of the 32-bits and 64-bits modules and *SDK* on the same computer is not possible (find details in [Configuring of using 64-bits modules](#)).

3.3 General requirements for mounting and configuring of cameras

On the page:

- [Camera location on the road](#)
- [Camera location at the security sites](#)
- [Setup of the lens focal length](#)
- [Camera setup](#)
- [General parameters of used video cameras](#)

3.3.1 Camera location on the road

By default, the cameras are installed at a height of 6 m above the controlled lane edge. The control zone center is located 20 m from the camera. The camera is tilted at an angle of 18 degrees. We recommend placing the cameras above the edge of the road, and not above the center. In this case, the horizontal inclination will amount to 4 degrees for the control zone width of 3 m.

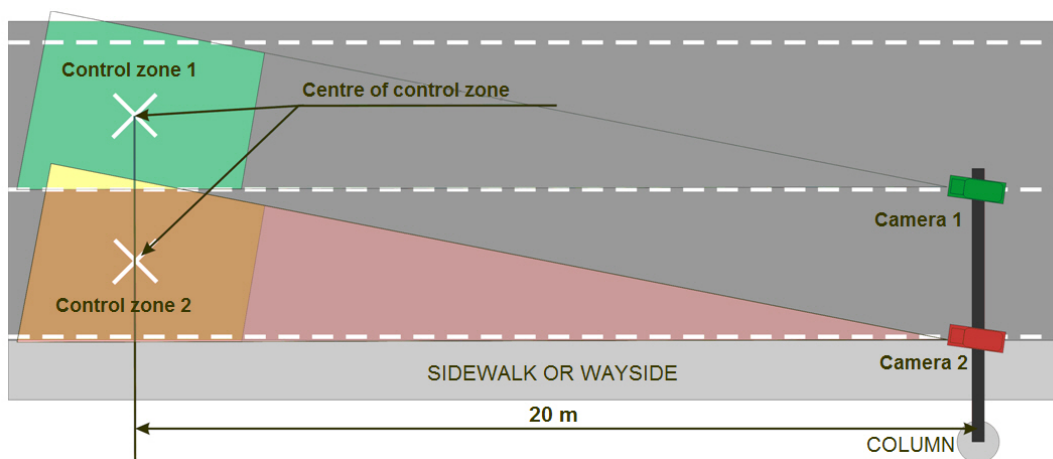

3.3.2 Camera location at the security sites

By default, the cameras controlling the security site entrances and exits are located at a height of 3 m above the lane edge. The control zone center is then located 11 m from the camera.

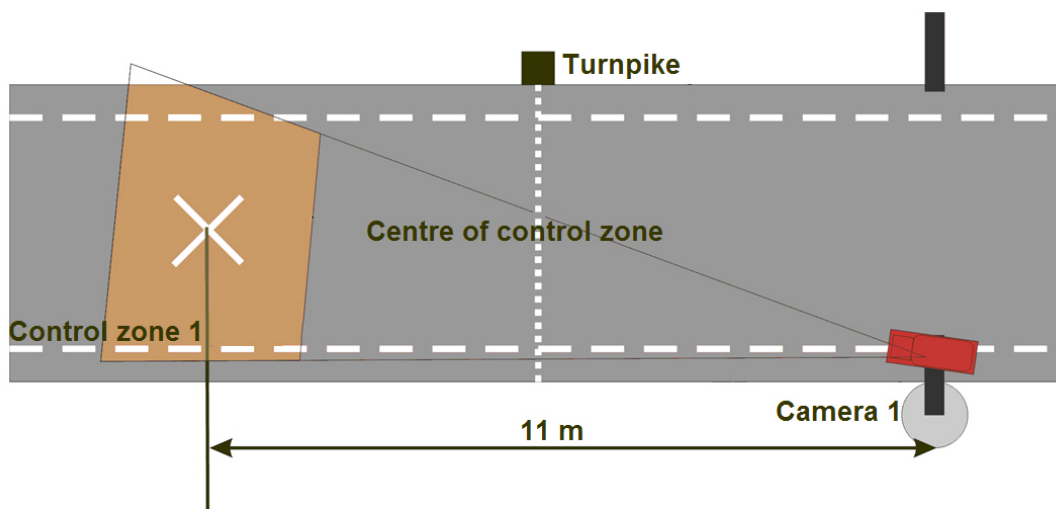

3.3.3 Setup of the lens focal length

After the camera is mounted, the lens focal length should be adjusted to the required viewing distance.

To set up the lens without the Urgan software, do the following:

1. Direct the camera at the road area where the license plate numbers are to be read;
2. Place a license plate in the center of the control zone. The plate should be perpendicular to the camera axis;
3. Zoom the lens to make the license plate occupy approximately 1/5 of the image at the center of the image;
4. Lock the zoom position;
5. Adjust the image sharpness.

3.3.4 Camera setup

To set up the camera, do the following:

1. Set the required shutter speed.

Note.

1/1000 sec is enough in most cases.

2. Set maximum sharpness and dynamic range of the signal, if the camera includes the video signal Level adjustment. Do the following:
 - 2.1 Aim the camera at a very bright object to catch as much light as possible (but not at the sun!). Decrease the Level value until the image disappears – the lens closes and the image becomes black.
 - 2.2 Gradually increase the Level value until the image appears.
 - 2.3 Close the lens for 5 sec using any opaque object (eg. the palm of your hand). Open the lens again.
 - 2.4 Make sure the image reappears. If the image does not appear, increase the Level value and check the image again.
3. Set the image sharpness. The sharpness should be set up under poor lighting conditions (approx. 10 – 100 lux), when the noise level is just below the signal level. To achieve such conditions, the dark lens filter can be used.

3.3.5 General parameters of used video cameras

General parameters of used video cameras are presented in the following table.

No	Property	Range	Comment
1	Camera type	CCTV	Analog and IP-cameras can be in use.
2	Camera resolution	Not less than 520 TVL horizontally.	Only high resolution CCTV camera usage guarantees the recognition rate declared in the technical characteristics of the system.
3	Illuminance of the monitored area	Not less than 50 lux for cameras with 0.05 lux CCD sensitivity; Not less than 20 lux for cameras with 0.0002 lux CCD sensitivity; 0 lux for cameras with IR illumination.	At night time, standard auto road illumination devices are sufficient to provide 50 lux illuminance in full compliance with the building regulations.
4	Automatic amplification adjustment	LOW or MIDDLE depending on the camera	This function must be enabled. Unfortunately, the scene is usually not sufficiently illuminated, thus the image looks too dark in case this function is disabled. Enabling this function amplifies the whole video signal including the CCD noise. The amplification value is chosen for each camera separately.
5	Auto aperture and auto electronic shutter	<ul style="list-style-type: none"> not more than 1/500 sec for vehicle speed below 40 km/h; not more than 1/1000 sec for fast motions (vehicle speed above 40 km/h). 	<p>The image should be sharp. Sharpness can be achieved by locking the shutter speed (exposure). Locking the speed of the electronic shutter is a very important function.</p> <p>When the exposure is long, i.e. the shutter speed is low (1/100, 1/50 sec), the moving objects are blurred in the image. This most affects the small details, eg. the symbols in license plate numbers. The video sequence as a whole may look good enough, but the static frames that comprise it may be blurred, making LP number recognition partially or completely impossible. If the video camera is not forced to operate at high shutter speed, it will automatically switch to long exposure in case of poor lighting conditions, preventing plates recognition. With the same settings, the video camera can recognize the numbers in bright light only, automatically switching to short exposure.</p> <p>If the video camera is installed at an angle more than 10 degrees to perpendicular to the license plate, we recommend to halve the shutter speed.</p>
6	Color	Black and white image	It is recommended to use black and white cameras unless it is necessary to store color pictures of the vehicle. This is because color cameras while having same characteristics have less sensitivity and pictures appear less sharp.
7	Video stream speed (fps)	See the corresponding module functionality description.	For proper recognition, the plate is to be fully observed and read at least in one frame. For getting the car direction, the plate is to be fully observed and read at least in two frames. The maximum speed of vehicles moving in the control zone is defined for each object and depends on the way of camera installation, what objective is in use, etc. In some frames the plate can be light-struck/darkened/covered depending on the traffic situation, the time of day, etc. To avoid such problems, it is necessary to increase the number of frames in which the plate is observed. It is achieved by the video stream speed-up or decreasing of maximum allowed speed of a car.

The following video camera requirements should be met in order to ensure the recognition of license plate numbers using the *Auto-Intellect* system.

- license plate number should be fully placed in the frame;
- symbols should be sharp, not smeared, undistorted, not overexposed, evenly lighted;
- symbols should be visually differentiated;
- technical requirements for the number plates should follow according government standards;
- without the effect of interlacing (on speed) for analog cameras.

4 Installation of Auto-Intellect software components

4.1 General description of the Auto Intellect distribution kit

Auto Intellect is supplied as a software installation package (distribution kit). The current version of the distribution kit can be downloaded from the official [AxxonSoft](#) website.

The distribution kit contains all the necessary software components for installing the *Auto Intellect* software package on a base computer.

The distribution kit allows you to install, restore and remove the *Auto Intellect* software package.

⚠ Attention!

- Prior to installing, restoring or removing the *Auto Intellect* software package, the *Intellect* operation should be shut down.
- Administrator rights are required for installing, restoring or removing *Auto Intellect*.

4.2 Installation of the Auto Intellect software package

Auto Intellect is installed as a part of *Intellect*. Information about compatibility of the *Intellect* software versions and *Auto Intellect* is presented in the [General information about product releases and versions compatibility](#) section.

⚠ Attention!

Auto Intellect should be installed on both **Server/Remote Administrator's workstation** and **Client**. For details, see [Intellect. Administrator's Guide](#).

To install *Auto Intellect*, do the following:

1. In the root directory of the distribution kit, run the setup.exe file.
2. To continue the installation process, click **Next**.



3. Read the terms of the license agreement carefully. Then set the radio button to **I accept the terms of the License agreement** and click **Next**.

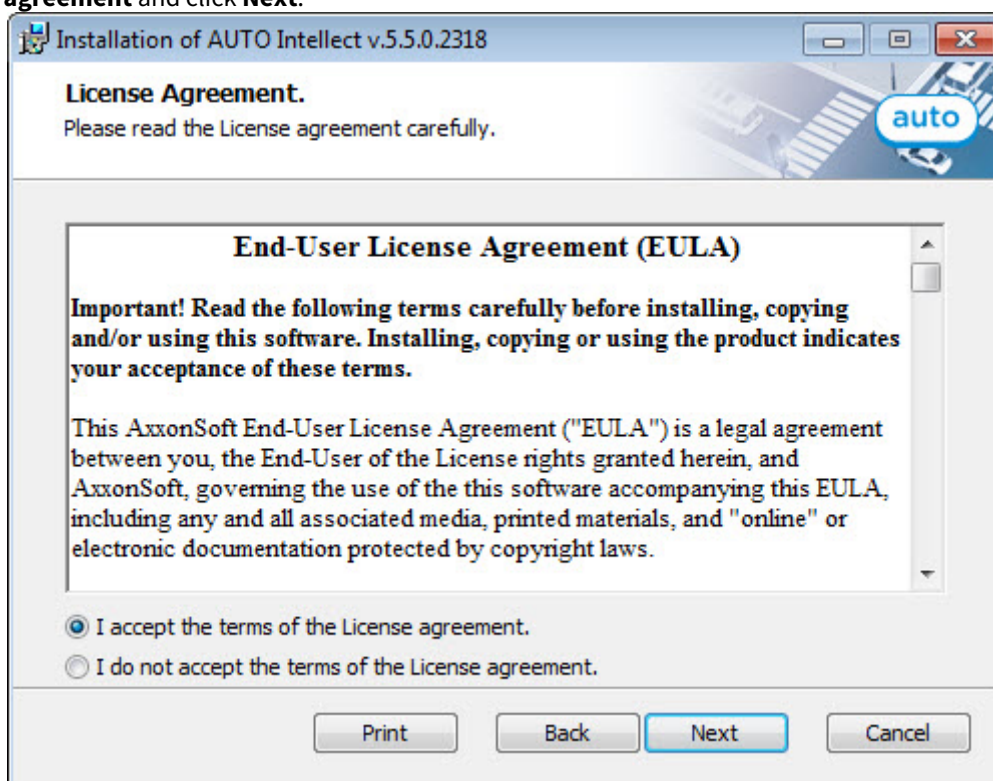

4. Select the database MS SQL Server and specify the authorization parameters for connection. For details, see [Installation of Intellect as a Server/Remote Administrator's workstation](#). To continue the installation process, click **Next**.

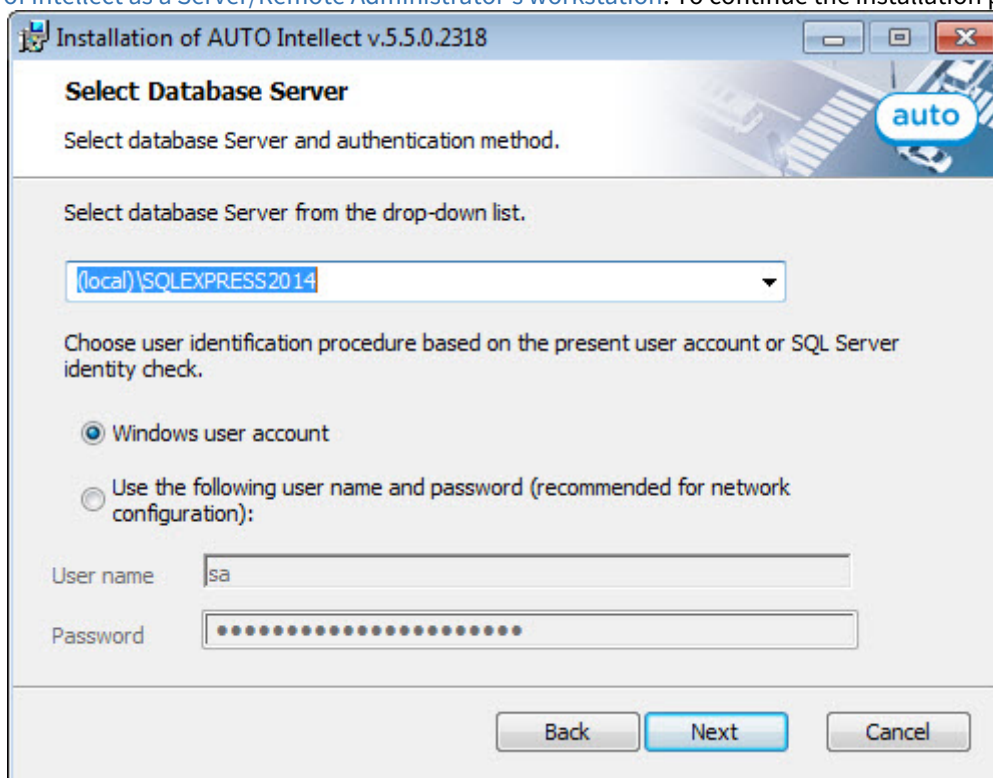

5. Specify the folder where the images of the recognized LP numbers will be stored. For more information about storing the images of the recognized LP numbers, see [Configuring the recognized LP images and vehicle images storage on disk](#).

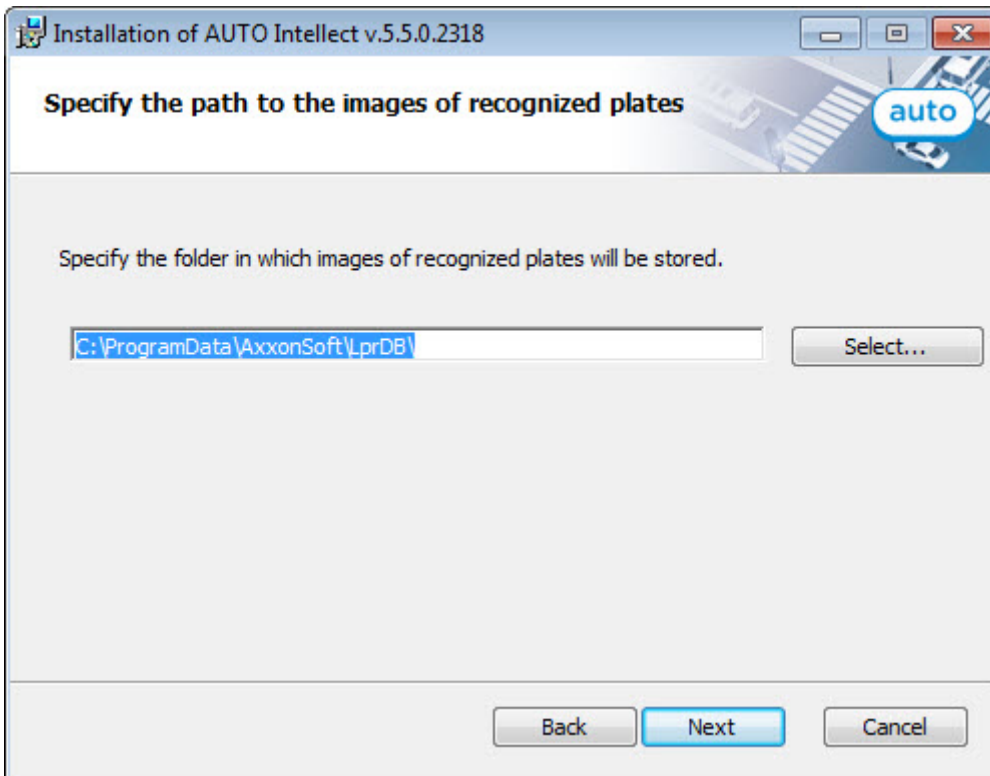

6. To start the installation process, click **Install**.

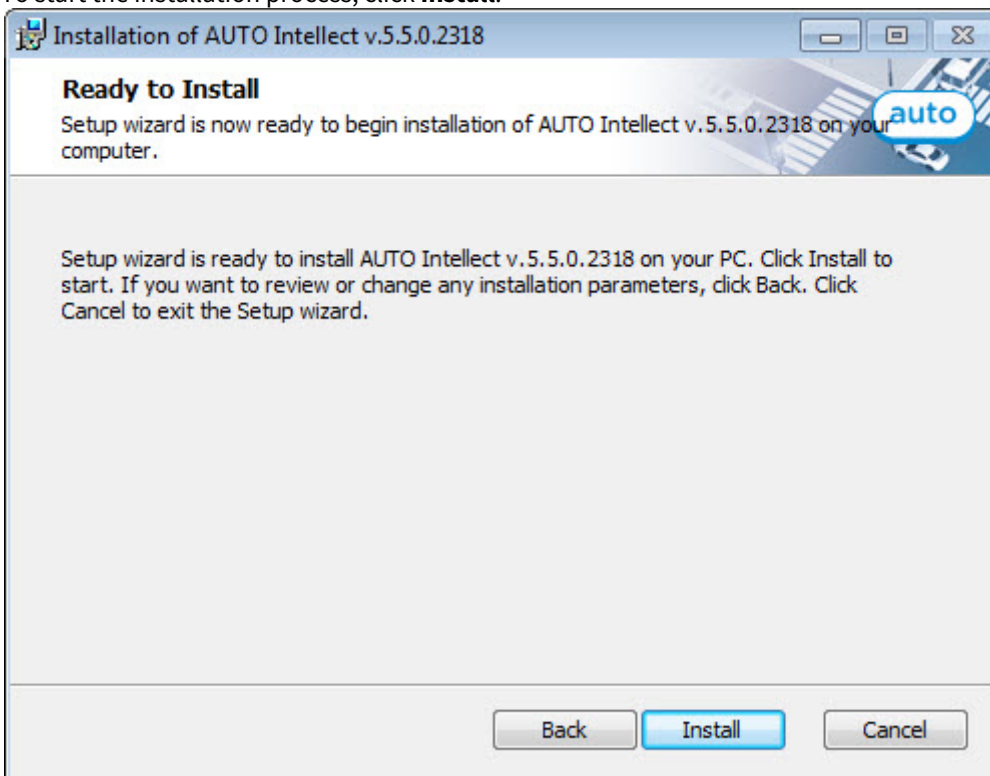

As a result, the necessary components of *Auto Intellect* will be copied to hard drive of your computer.

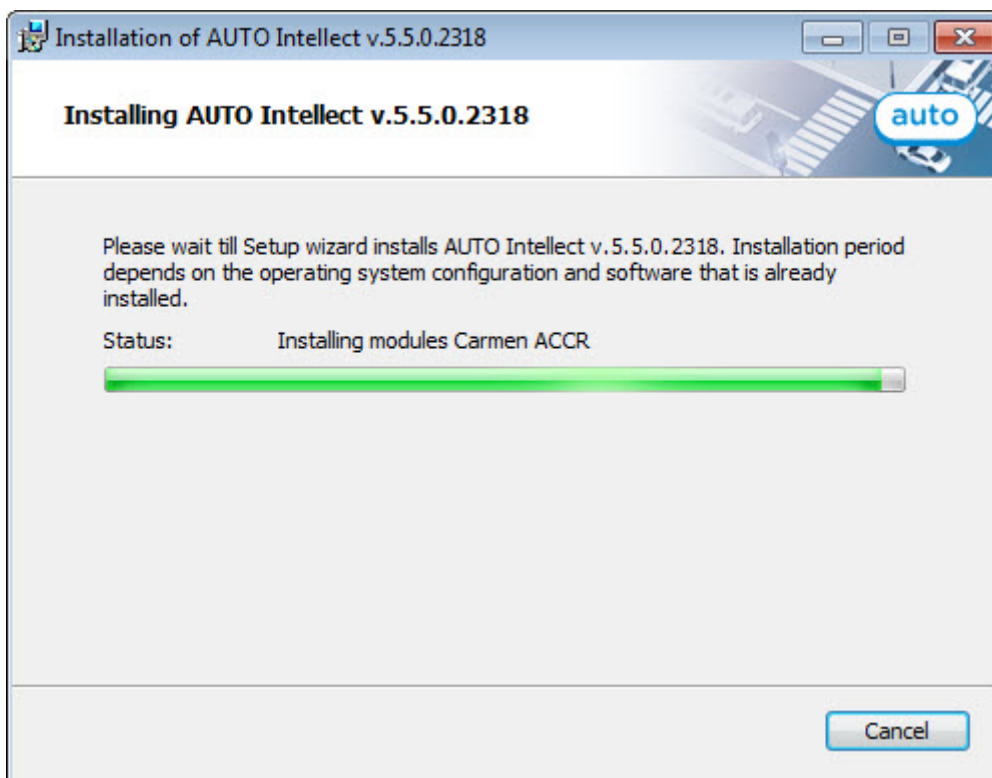

7. After all software components are successfully copied on your hard drive, the message about the completion of the installation process will be displayed. Click **Finish**.

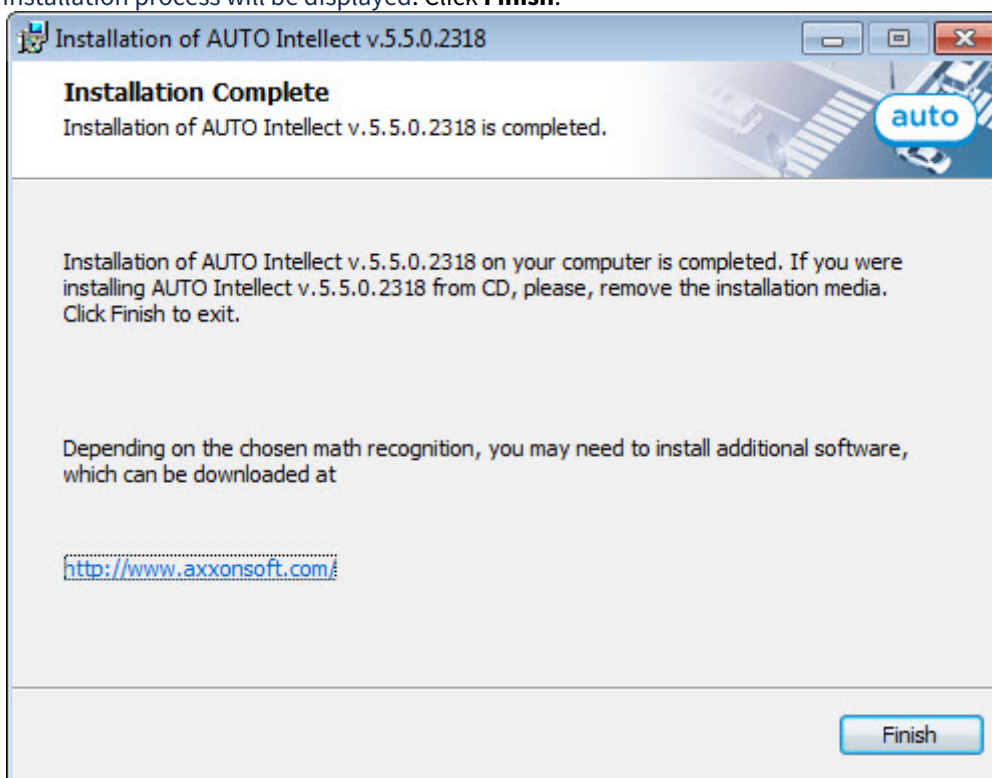

It is necessary to restart the computer for the configuration changes to take effect. To restart your system automatically, click **Yes**. To restart your system manually, click **No**.

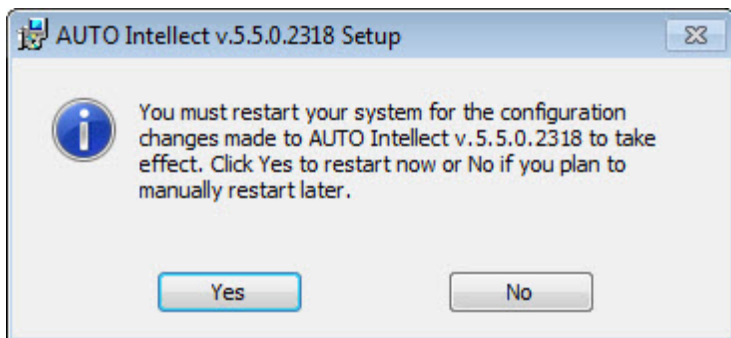

Auto Intellect installation is completed.

4.3 Repairing the Auto Intellect software package

The repair mode is used if *Auto Intellect* software components need to be re-installed.

To repair the *Auto Intellect* software, do the following:

1. In the root directory of the distribution kit, run the setup.exe file.
2. Select the **Repair** operation type and click **Next**.

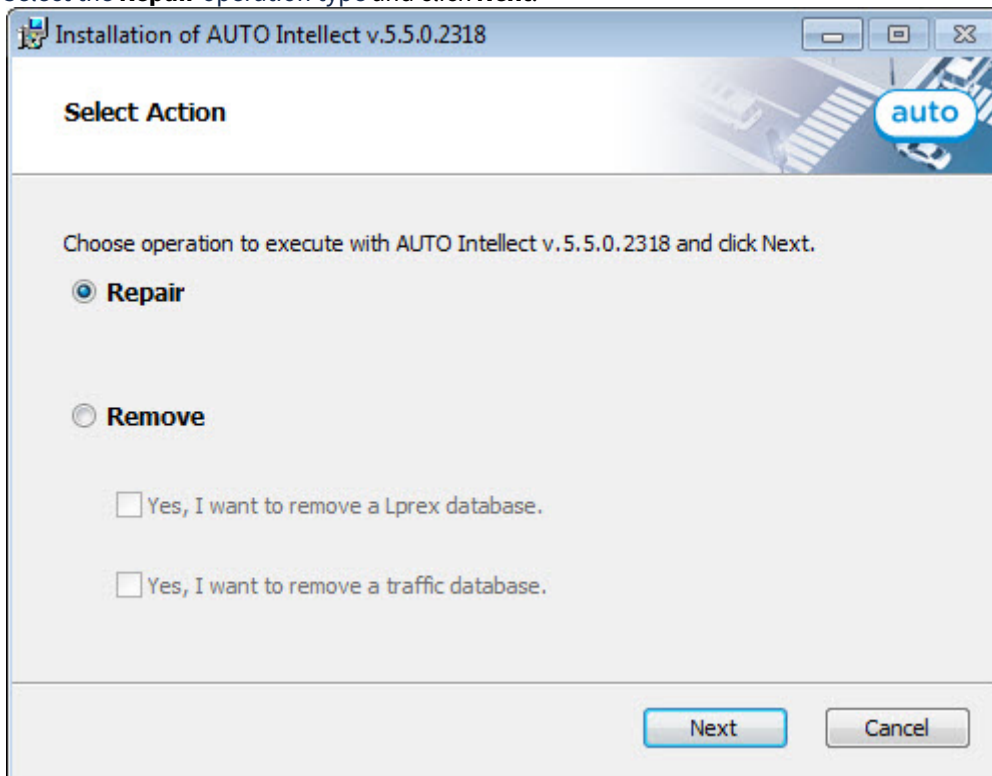

3. As a result, the installed components will be checked and the necessary components of the *Auto Intellect* software package will be copied to hard drive of your computer.

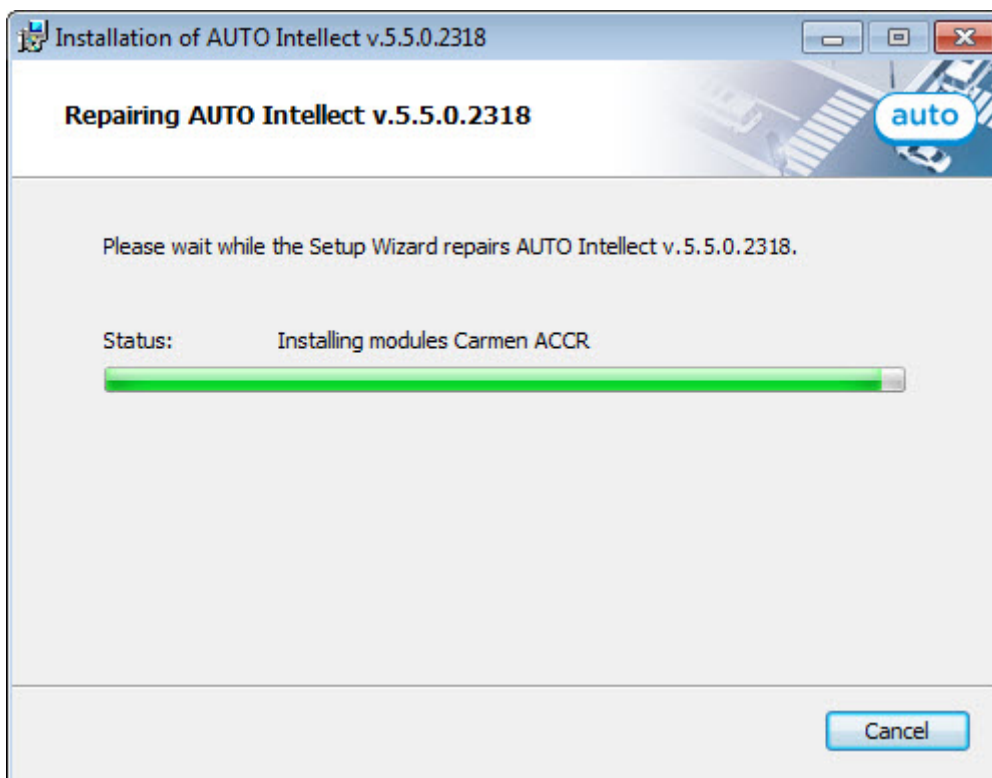

After all software components are successfully copied on your hard drive, the message about the completion of the repairing process will be displayed. Click **Finish**.

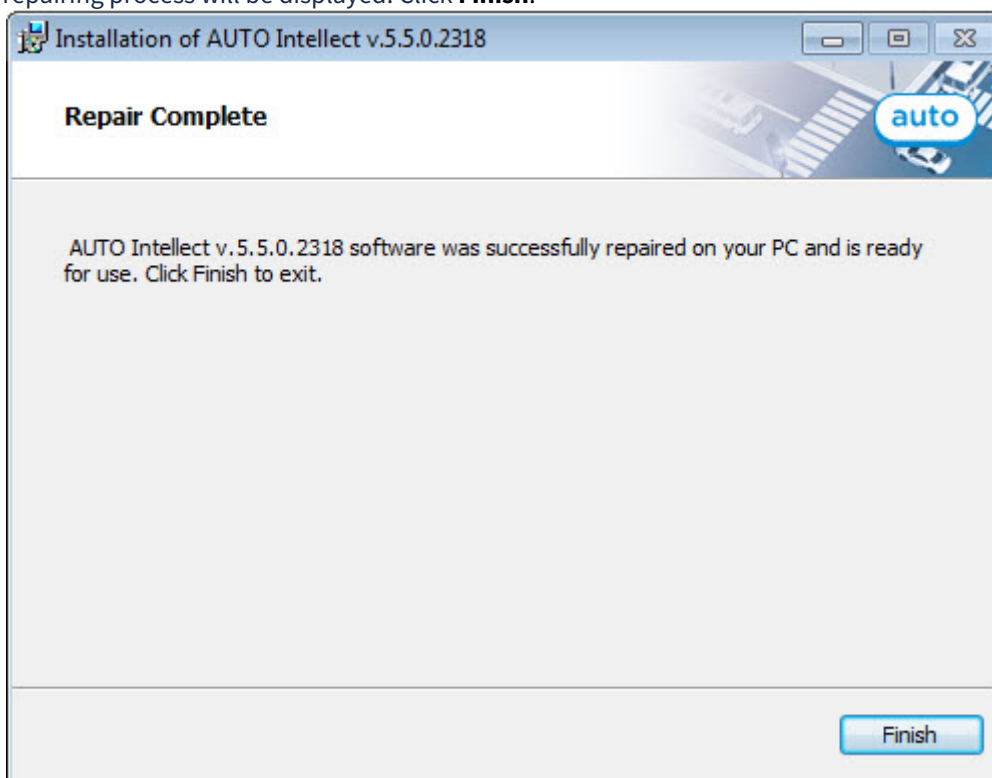

4. It is necessary to restart the computer for the configuration changes to take effect. To restart your system automatically, click **Yes**. To restart your system manually click **No**.

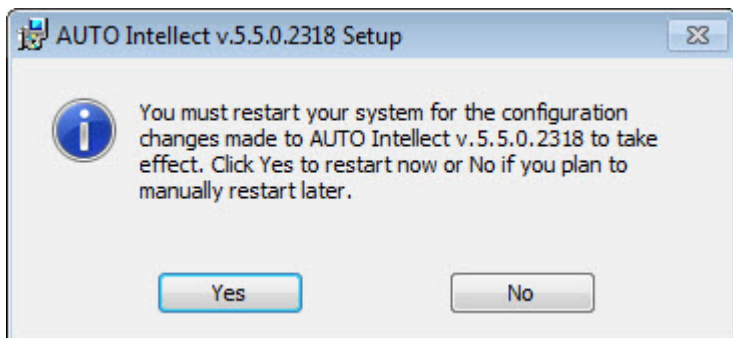

Repairing the *Auto Intellect* software complex is completed.

4.4 Removing the Auto Intellect software from the computer

To remove the *Auto Intellect* software, do the following:

1. In the root directory of the distribution kit, run the setup.exe file.
2. Select the **Remove** operation type and click **Next**.

i Notes

- To also remove the *Auto Intellect* recognizer database, set the **Yes, I want to remove a Lprex database** checkbox.
- To also remove the *Auto Intellect* **Traffic Detection** module database, set the **Yes, I want to remove a traffic database** checkbox.

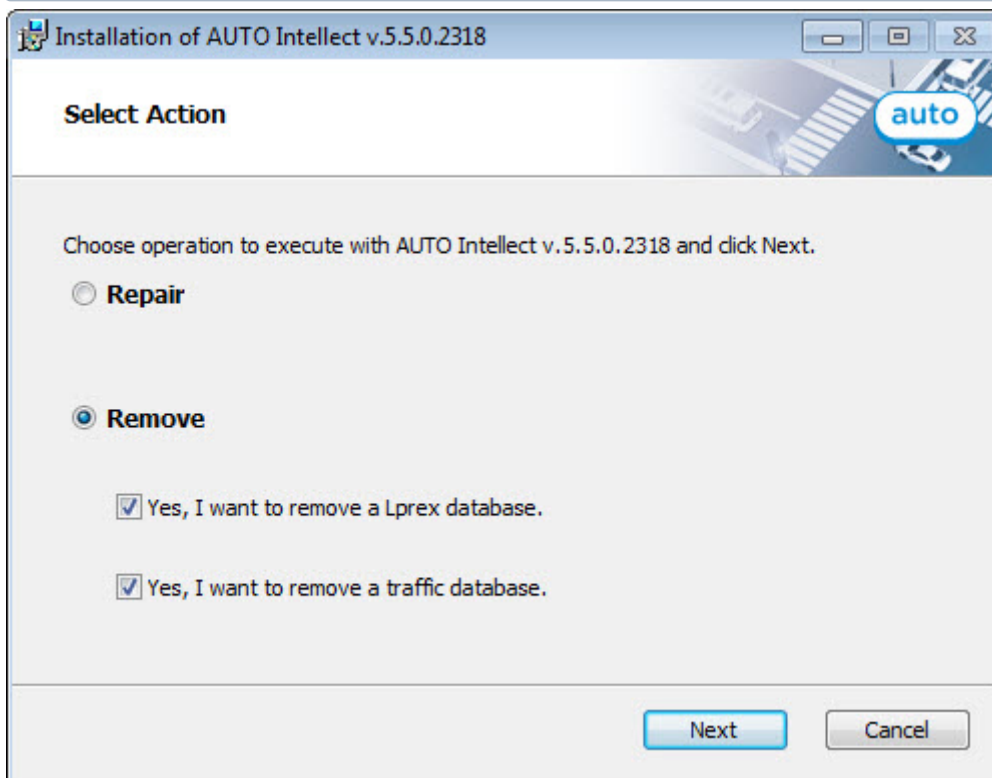

As a result, the process of removing the installed components of the *Auto Intellect* software package from the hard drive of the computer will begin.

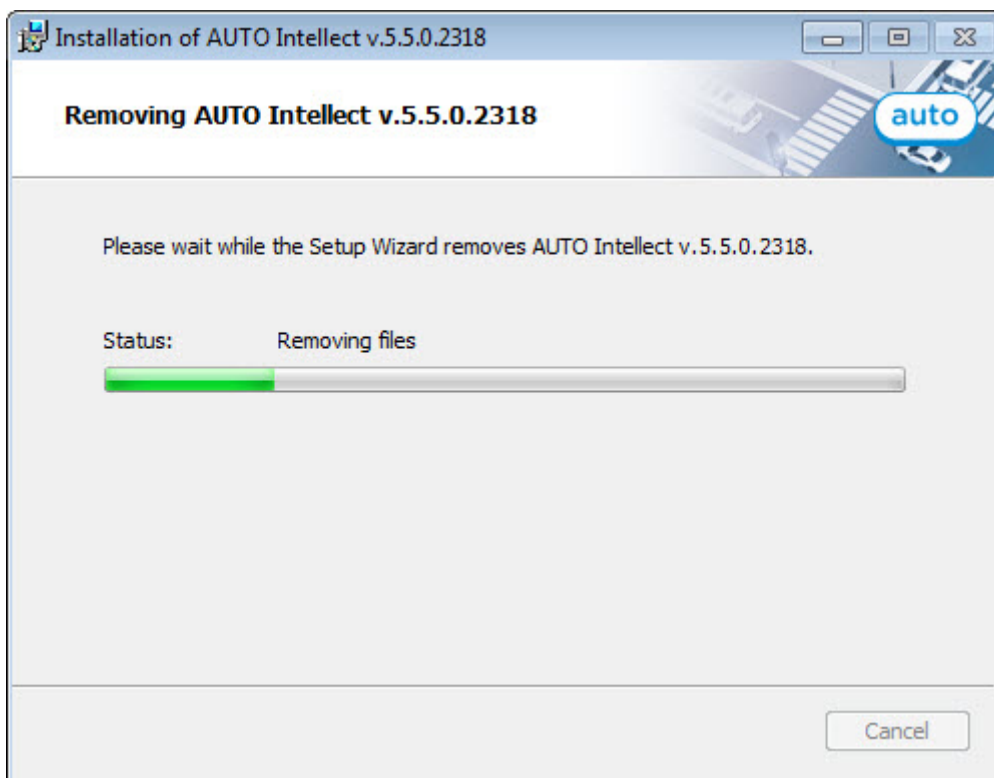

3. After all software components are successfully removed from hard drive, the message about the completion of the removing process will be displayed. Click **Finish**.

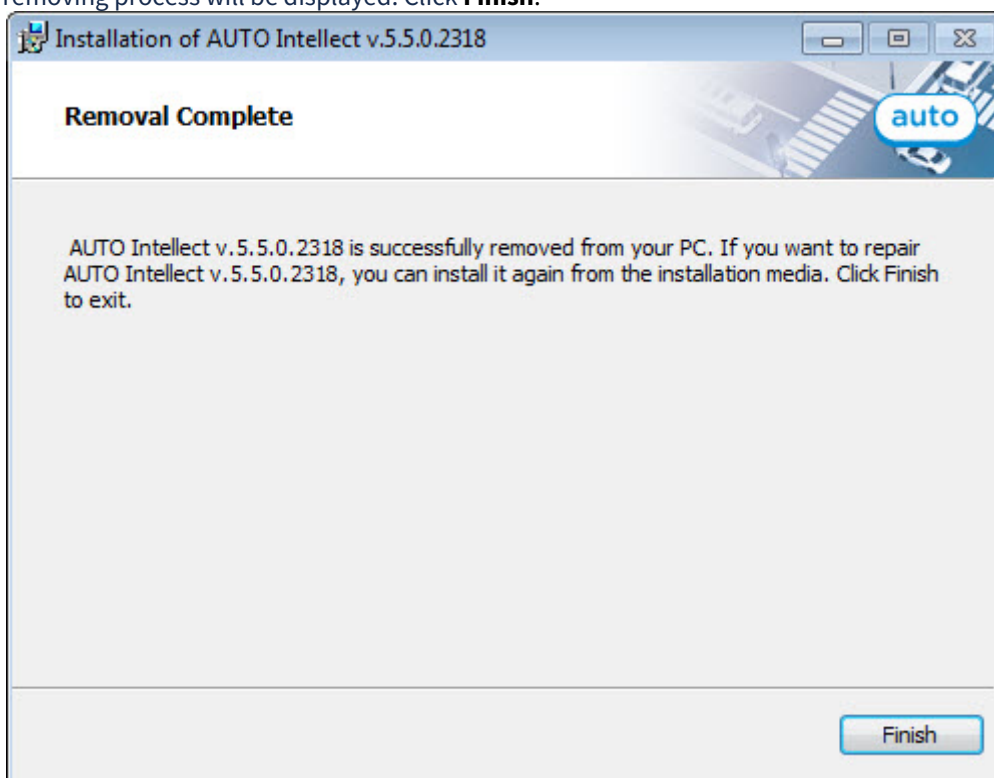

Removing the *Auto Intellect* software is completed.

4.5 Possible problems during installation

On the page:

- Intellect software package is installed as a service
- Files that need to be updated by Auto intellect installer are used by another application

4.5.1 Intellect software package is installed as a service

In case when Intellect software package is installed as a service some problems can occur during installation, repairing, removing of *Auto Intellect* software package. If installation program can't close all applications and processes that use files that need to be updated then the corresponding dialog box is displayed.

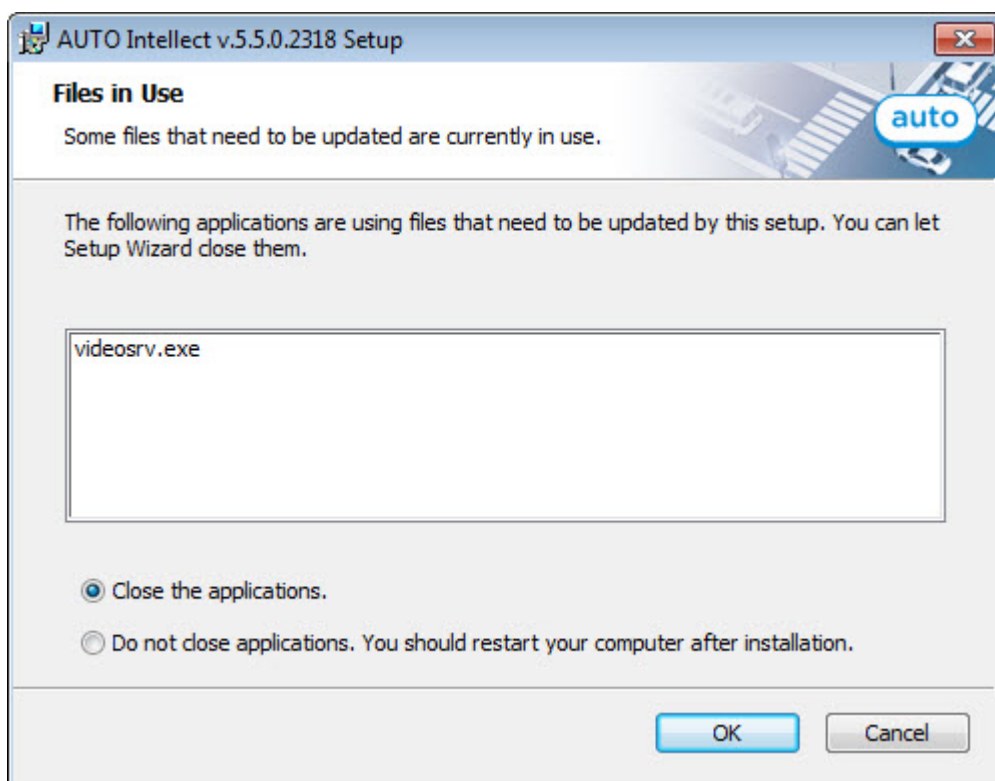

Attention!

This dialog box can change according to OS in use.

To continue installation it's necessary to shut down the application that uses this file and click **OK**.

4.5.2 Files that need to be updated by Auto intellect installer are used by another application

When during repairing or removing of *Auto Intellect* software package the file that need to be updated is used by another application then the dialog box that reports about it is displayed.

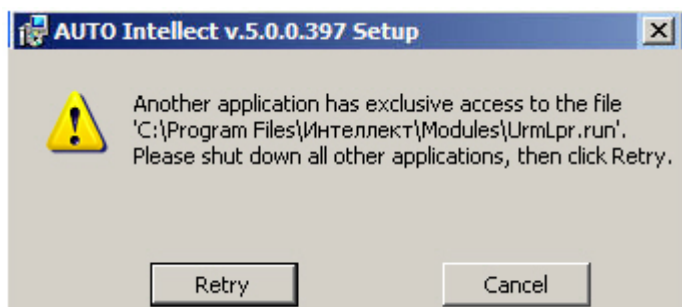

To continue installation it's necessary to close the application that uses this file and click **Retry**.

4.6 Remote installation, deinstallation and update of Auto Intellect

You can remotely install, deinstall and update *Auto Intellect* using the `wmic.exe` command line utility. This utility is a part of Windows OS. To run the utility, enter "wmic" without quotation marks in Windows command line.

Detailed information about this utility can be found on Microsoft technical documentation page <https://docs.microsoft.com/en-us/>. At the moment of creating this section, the description of the utility is available at <https://docs.microsoft.com/en-us/windows/win32/wmisdk/wmic>.

Note

The `wmic.exe` utility does not work correctly with VMware virtual machines. It is not guaranteed to work with other virtual machines.

To run `wmic` on a remote computer, you should disable UAC (for instructions on how to do this, see [OS settings for correct operation of Remote Admin Workstation or Server](#)).

The installation, deinstallation, and upgrade methods described in this section apply to domain and extra-domain computers.

It is necessary to copy *Auto Intellect* distribution kit to the computer local disks where the installation will be performed in advance.

To do this, you can use the following command line script:

```
xcopy %Path_to_folder_with_distribution_kit% %Network_folder_on_the_target_PC% /e
```

where:

- `%Path_to_folder_with_distribution_kit%` is the path to the folder with the distribution kit on the local computer.
- `%Network_folder_on_the_target_PC%` is the path to the folder on the computer where you want to install the software. You should have the write access to it.
- The `/e` attribute copies all subdirectories and their contents, including empty directories.

Note

The UNC path is in the format `\\<server IP address>\<Shared folder on this server>\...`. The ellipses here represent the path from the shared folder to the folder with the distribution kit. If you are installing on the computers in the domain, specify the address of the server that contains the distribution kit folder available to all computers.

Detailed information about the `xcopy` utility can be found on Microsoft technical documentation page. At the moment of creating this section, the description of the utility is available at [https://docs.microsoft.com/en-us/previous-versions/windows/it-pro/windows-xp/bb491035\(v=technet.10\)](https://docs.microsoft.com/en-us/previous-versions/windows/it-pro/windows-xp/bb491035(v=technet.10)).

Note that the installation method described in this section allows you to install or upgrade only the core product without any add-ons.

4.6.1 Remote installation of Auto Intellect

In order to install *Auto Intellect* on a remote computer, run the following command with the wmic.exe utility:

```
/NODE:"Computer_name" /USER:"User_name" /PASSWORD:"Password" product call install true,
"%installer parameters%", "%Path_to_folder_with_distribution_kit%\Product.msi"
```

Here:

- /NODE - the name of the target computer on which *Auto Intellect* is being installed.

Note

The NODE list can be a text file that specifies the names of the target computers in column.

- /USER and /PASSWORD - login and password of the user who has the rights to install the software on the remote computer.
- "%Path_to_folder_with_distribution_kit%\Product.msi" - path to the Product.msi installer file you need to run. It is the local path to the folder to which you copied the distribution kit.
- %installer parameters% - installer options. The following parameters can be applied to Product.msi:
 - a. The parameters that can be applied to any msi file (for reference, run the msixec.exe /? command in the command line from <WINDOWS>\system32\ directory).
 - b. The parameters described in the setup.exe help article in the /CMD="[commands]" section (for reference, run the setup.exe /? command in the command line from the installer folder. These commands are also described in [Installing INTELLECT™ software in a silent mode](#) section).
 - c. The parameters that are set in setup.exe during installation:
 - CMD_INSTALLTYPE – Client, Server, Admin.
 - REMOVEALL (0, 1) – removal with/without saving the configuration.
 - NOOSCHECK=1 – disable the OS compatibility check.

Note

The operation of these parameters is not guaranteed if there is a branch in the registry:

- For x86 system: HKEY_LOCAL_MACHINE\SOFTWARE\ITV\INTELLECT\InstallPropertyInfo
- For x64 system: HKEY_LOCAL_MACHINE\SOFTWARE\Wow6432Node\ITV\INTELLECT\InstallPropertyInfo

The branch has the parameters of the previous installation.

Example

Example of an installer parameter string:

```
REBOOT=ReallySuppress LANGUAGE="ru" TRANSFORMS="%Path_to_folder_with_distribution_kit%
\languages\Setup\ru\ru.mst" CMD_INSTALLTYPE="Server"
```

In the example above:

REBOOT=ReallySuppress cancels computer reset at the end of installation.

LANGUAGE="ru" selects the product language. The default product language is English.

TRANSFORMS="%Path_to_folder_with_distribution_kit%\languages\Setup\ru\ru.mst" specifies the path to the installer language mst-patch (specifies the installer language).

CMD_INSTALLTYPE="Server" specifies *Intellect* installation type - Server. It can also take the Admin value (if Remote Administrator's workplace installation type is required) and Client (if Remote Client installation type is required).

4.6.2 Remote update of Auto Intellect

In order to update *Auto Intellect* to a newer version remotely, do the following:

1. Run the installation of the new version as described in [Remote installation of Auto Intellect](#).

2. In the installation command, specify the path to Product.msi for the newer version.

The old version will be deleted automatically. The configuration will be saved. The newer version will be installed.

4.6.3 Remote deinstallation of Auto Intellect

In order to deinstall *Auto Intellect*, run the following command in the wmic.exe utility:

```
/NODE:"Computer_name" /USER:"User_name" /PASSWORD:"Password" product where  
name="Product_name" call uninstall
```

Here Product_name is the name under which *Auto Intellect* is installed. In the English version, this is usually "AUTO Intellect v.Build_number". The name can be found in the registry in HKEY_LOCAL_MACHINE\Software\Microsoft\Windows\CurrentVersion\Uninstall section.

5 Configuring the Auto-Intellect software package and setting up its components

5.1 The configuration and setup procedure of the Auto-Intellect software package

The *Auto-Intellect* software configuration is performed on the basis of *Intellect* software platform. Necessary system objects for video subsystem performing are considered to have already been configured and set up (see [Configuring video subsystem](#) section in the reference manual [Intellect software package: Administrator's guide](#)).

The second stage in configuring the *Auto-Intellect* software is to create and set up system objects, necessary for processing the received video in order to identify plates, speed and type of the vehicle in the video surveillance area and also to create databases for storing the received information.

Note.

The database of identifiers/detections and the object from which the data is received to this database are to be located in one computer for correct working of *Auto-Intellect* software package.

The program module **Traffic Detection** is used for identifying the type of the vehicle. The **Radar** module is designed for identifying the speed of the vehicle.

If the **ARENA** module is used and the *Auto-Intellect* software should be set up, create and set up the following objects:

1. **LPR channel** (should be only created, not set up);
2. **ARENA** module;
3. **Vehicle Tracer** interface object.

If the LP recognition modules are used and the *Auto-Intellect* software should be set up, it is necessary to create and set up the following objects:

1. LPR channel;

Note.

LPR channel object is designed for creating the multipurpose settings of the recognition modules.

2. The corresponding LP recognition module (see [Activating the software module used for identifying the plates](#)).

Attention!

With the growing number of **CARMEN-Auto** identifiers on the *Auto-Intellect* server the rate of video processing by every identifier goes down, that results in lesser percent of the identified characters. Results delay and missing of frames are also possible. The rate of video processing by **CARMEN-Auto** can also depend on the model, resolution, color and other camera's parameters.

3. **Radar module** (if LPR channel is used simultaneously with **Radar** module);
4. **External Plates DB** (if LPR channel is used simultaneously with external Plates database);
5. **Vehicle Tracer** interface object.

To set up the *Auto-Intellect* software, when **Vehicle Tracer** is used, the following system objects should be created and set up:

1. **Traffic Detection**;
2. **Traffic Monitor** interface object.

To set up the subsystem, gathering information about vehicle streams, the following system objects should be created and set up:

1. **IntelliVision vehicle detection**;
2. **Vehicle Processor**.

5.2 Configuring the program modules

5.2.1 Activating the software module used for identifying the plates

Activate one of the following software modules for license plates recognition:

1. ARENA module;
2. ARH-Railway module;
3. AUTO-Uragan module;
4. Bioiris module;
5. CARMEN-Auto module;
6. CIDR IntelliVision module;
7. IntLab module;
8. LPR IntelliVision module;
9. RIDR IntelliVision module;
10. Remote recognition;
11. RoadAR module;
12. Taiwan module;
13. VIT module.

To activate the software module, create the same-name object on the basis of the **LPR channel** object.

Note

After creating the recognition module object, except the **Bioiris**, **Taiwan**, or **Remote recognition**, it is necessary to configure it.

Attention!

- After creating or configuring the license plates recognition modules, it is necessary to go to the **LPR channel** settings panel and click the **Apply** button.
- Some settings can be not available for some modules. If a setting is only applied for several modules, it is indicated on the corresponding page.

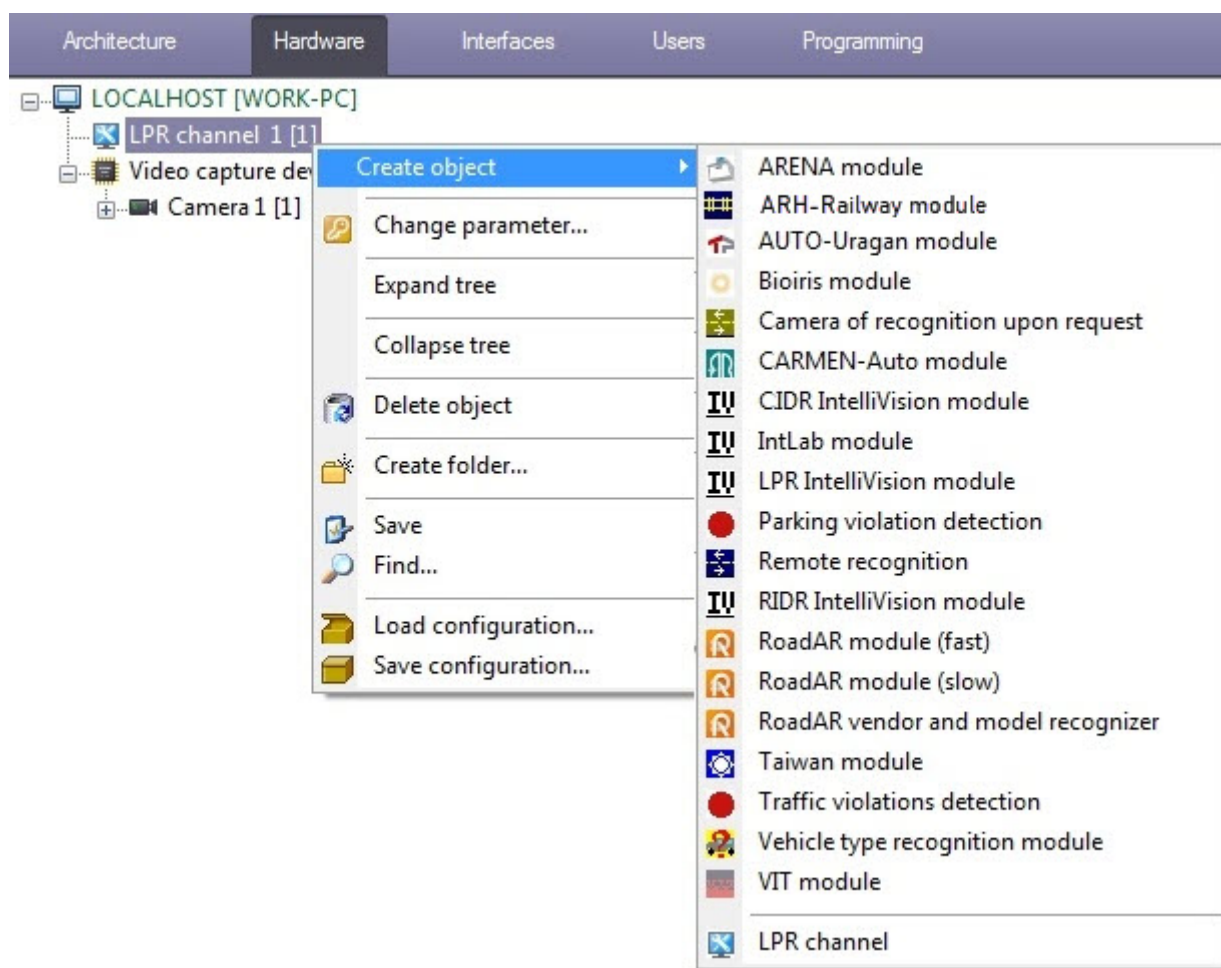

5.2.2 General information on Neural analytics

✓ Software and hardware requirements

The Auto-Intellect Software Package uses the AI analytics based on neural networks. The following AI features are available:

1. **Vehicle Type Recognition** (see [Vehicle Type Recognition module](#)).

The **Vehicle Type Recognition** module performs vehicle type recognition using a neural network.

📘 Note

See also [Saving the frames processed by the Vehicle Type Recognition module](#)

The quality of work and resource consumption of software modules based on a neural network directly depend on the optimization of the neural network model they use.

Before you start setting up a software module based on a neural network, you should contact the [AxxonSoft](#) technical support and request the files of the trained neural networks models. Technical support specialists will request the required data and then provide files for each neural network model. These files should be distributed to all Servers where it is planned to use the corresponding software modules.

⚠ Attention!

The startup (initialization) time of each neural network on NVIDIA GPU can take several minutes, depending on the neural network model used. Until the initialization is complete, no events will be received from the software module.

5.2.3 Features of Auto Intellect modules operating in VMWare

Note

Find the list of *Auto Intellect* modules that support VMWare operation in [Intellect software working in virtual machines](#).

For the **LPR IntelliVision** module, copy the license key to the *<Intellect installation folder>Modules64* and apply the MAC address in order to activate it in VMWare.

For the **VIT**, **AUTO-Uragan** and **CARMEN-Auto** modules, connect the USB key to the computer where the VMWare is installed in order to activate their license keys. The USB key will be discovered and connected automatically (the **Removable Devices** box appears where **OK** is to be clicked).

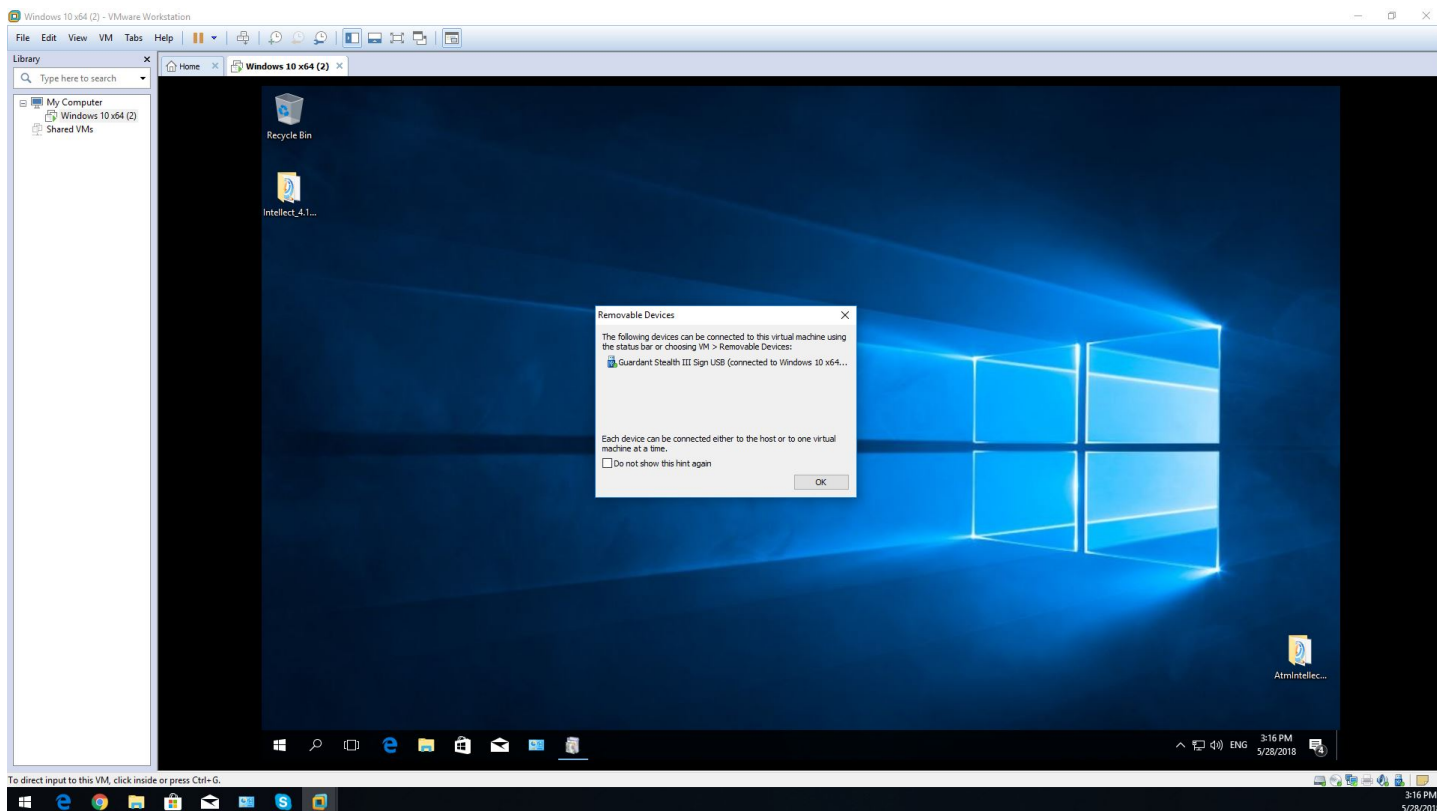

Note

If the USB key is not discovered automatically, then connect it manually: **VM (1)** → **Removable devices (2)** → **USB (3)** → **Connect (4)**.

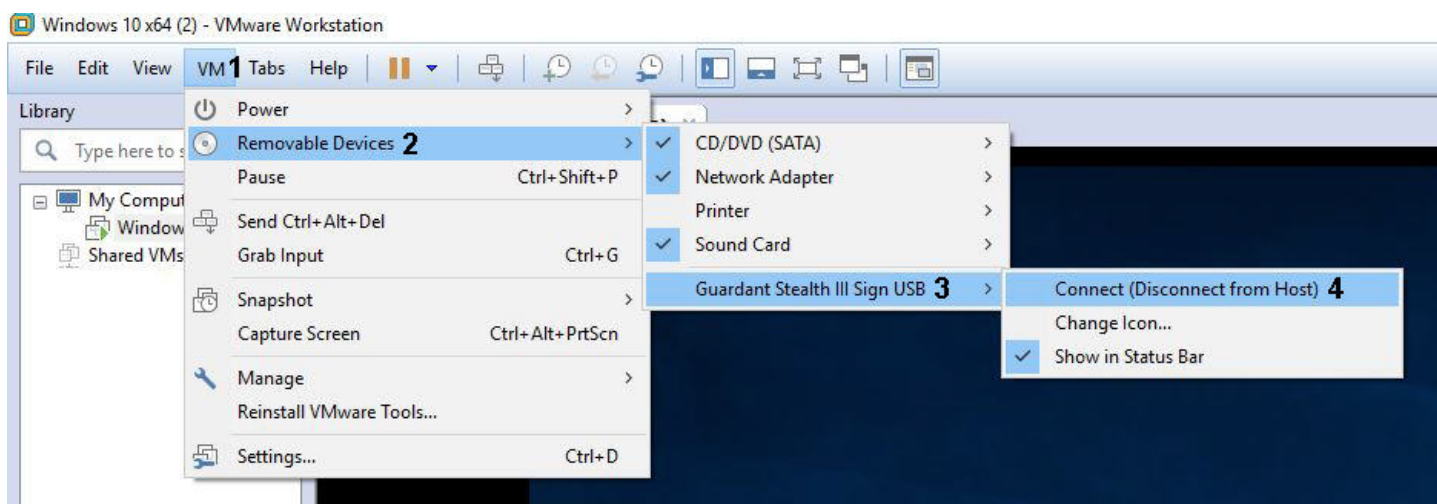

5.2.4 AUTO-Urgan

5.2.4.1 The AUTO-Urgan module functionality

The **AUTO-Urgan** software module supports the following functionality:

1. License plates identification;
2. Saving the identified number to the plates detector database;
3. Identification and logging the determined speed of the vehicle to the plates database (by video or using the **Speed traps server** module);
4. Identification and logging the determined class of a moving vehicle to the plates database (while connecting the **Traffic detection** module);
5. Check of identified license plates via connected search database;
6. Possibility to work with multilane driveway;
7. Identification of extended list of license plates types: all types of Russian license plates, all CIS countries and Baltic States, countries of Europe, Latin America and The USA. Worked out the main types of single- and double-line plates of different countries, for each both civil and specialized (diplomatic, transit, military etc.). The full list of countries is given below.
8. Plates filtration according to their characters' sizes
9. Possibility to change level of plates' identification quality
10. Saving the frames of the identified plates to bmp, jpeg and avi formats
11. Calculation of the capture lanes in the area of identification restriction
12. Setting the alarm when the vehicle entering an oncoming lane.

The **AUTO-Urgan** software module uses the IPP 6.1 library.

The **AUTO-Urgan** software module can work in one of the following modes: Slow or Fast (for more detail see [AUTO-Urgan module licensing](#)).

AUTO-Urgan module allows recognition of vehicles' license plates of the following countries:

Note.

The list of countries below is actual at the moment of documentation creation. Contact an AxxonSoft manager to find out the most relevant list of countries supported.

1. **CIS + Baltic + Georgia**
 - a. Abkhazia
 - b. Belarus
 - c. Georgia
 - d. Kazakhstan
 - e. Kyrgyzstan
 - f. Latvia

- g. Lithuania
- h. Moldavia
- i. Russia
- j. Tajikistan
- k. Turkmenistan
- l. Uzbekistan
- m. Ukraine
- n. Estonia
- o. South Ossetia

2. Europe

- a. Austria
- b. Belgium
- c. Bulgaria
- d. Bosnia and Herzegovina
- e. United Kingdom
- f. Hungary
- g. Germany
- h. Greece
- i. Denmark
- j. Spain
- k. Italy
- l. Luxembourg
- m. Netherlands
- n. Norway
- o. Poland
- p. Portugal
- q. Romania
- r. San Marino
- s. Slovakia
- t. Slovenia
- u. Turkey
- v. Finland
- w. France
- x. Croatia
- y. Czech Republic
- z. Switzerland
- aa. Sweden

3. North and South America

- a. Argentina
- b. Brazil
- c. Paraguay
- d. USA
- e. Uruguay

4. Africa

- a. Morocco
- b. Tanzania
- c. South Africa

5. Southeast Asia

- a. India
- b. Malaysia
- c. Singapore
- d. Thailand

6. Australia and Oceania

- a. Australia
- b. New Zealand

Note.

Missing countries except for the listed above can be added into the recognition module if necessary. For that, contact your AxxonSoft manager and provide him or her a video recording with license plates of the required country. The final decision on adding a country to the module is made by the module manufacturer.

Attention!

Ask the manager of AxxonSoft company about the possibility to recognize special licence plates (e.g. two-lanes, motorcycles' LP, special vehicles' LP) for each country.

5.2.4.2 AUTO-Uragan module licensing

There are two types of license for **AUTO-Uragan** program module:

1. Slow — the module processes the video stream with the speed not exceeding 3 fps and recognizes license plates of vehicles moving with speed not more than 10 km/h.
2. Fast – the module processes the video stream with the speed not exceeding 25 fps and recognizes license plates of vehicles moving with speed not more than 150 km/h.

Attention!

Licensing of the **AUTO-Uragan** module depends on the number of motion lanes in the video camera control area. Calculation of the numbers of motion lanes is performed by internal module logic and depends on automatically defined typical minimal and maximum sizes of license plates (see the [Setting up the Auto-Uragan module](#) section). For example, the Uragan Fast 2 allows using of two cameras, each of which controls one lane, or one camera controlling two lanes.

Maximal width of motion lane is 3.5 m. So if the width of video camera control area more than 3.5 meters, the license for 2 channels of the **AUTO-Uragan** module is required. If the width of control area more than 7 meters, the license for 3 channels is required.

Selected area of recognition is considered while licensing if it is specified in settings of the **AUTO-Uragan** program module. The whole frame is considered if area of recognition is not specified. Detailed information about specifying areas of recognition is presented in the [Setting the LP number search area border](#) section.

There is an electronic hardware security key for the **AUTO-Uragan** program module (*Guardant*), which depends on the SDK version used (see [Setting up the AUTO-Uragan module](#)). The key can be remotely updated when it is required (to expand the permanent key or convert demo key to the permanent key).

Important!

The **AUTO-Uragan** hardware security keys are not summed up.

5.2.4.3 Video camera mounting and setup requirements for the AUTO-Uragan software module

The following camera functions should be disabled:

1. Video information accumulation mode / night mode;
2. Permanent automatic image sharpness adjustment;
3. Motion detectors;
4. Any information from the camera (name, date, time, etc) inserted in the video image.

The declared recognition quality is guaranteed if the cameras are installed at angles of not more than 20 degrees to the perpendicular to the plate. In case of larger angles (up to 45 degrees) the numbers will be recognized, although the recognition accuracy will decrease.

The following table shows the main parameters required for camera installation.

Parameter	Maximum value	Recommended (optimal) value
Camera height	20 m	6 m
Vertical inclination	30°	18°
Horizontal inclination	20°	5-10°
Maximum inclination of the license plate	10°	10°

Control zone width of a CCTV camera:

- 3 m – frontal camera location;
- 3.2—3.7 m - side location with an angle of no more than 10-20°.

Zone width of a 1 Mpix digital camera:

- 6.5 m – frontal location.

Zone width of a 3 Mpix digital camera:

- 11 m – frontal location.

Basic characteristics of used video cameras are presented in the [General requirements for mounting and configuring of cameras](#) section.

5.2.4.4 Setting up the AUTO-Uragan module

Setting up the **AUTO-Uragan** program module is done in the following way:

1. Go to the **AUTO-Uragan module** object settings panel, which is created on the basis of the **LPR Channel** object.

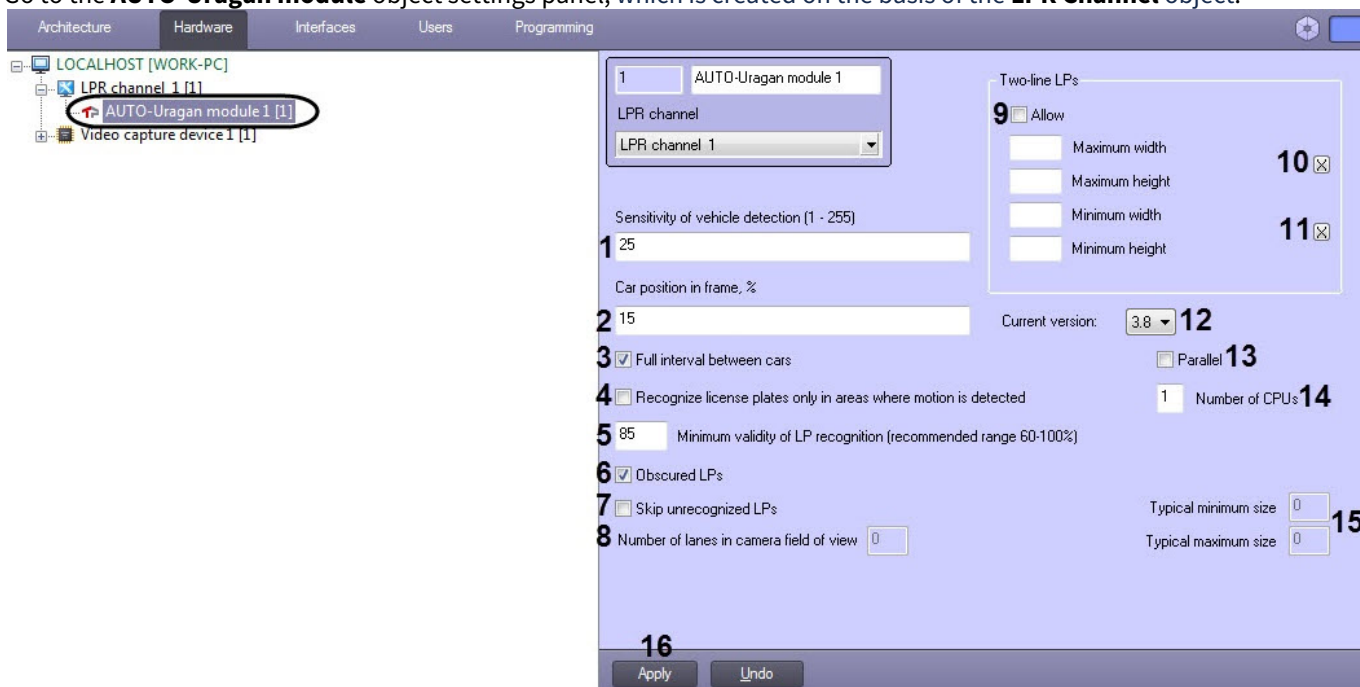

2. In the **Sensitivity of vehicle detection (1-255)** field (1) enter the sensitivity value which characterizes the motion detector's sensitivity by the contrast of video image. While recognizing the **AUTO-Uragan** module defines the vehicle dimensions. The lower value, the more detector sensitivity. The **Sensitivity of vehicle detection** parameter value is matched by testing the detector on false triggering.
3. In the **Car position in frame, %** field (2) enter the value in percent, showing the position of car in displayed frame. This adjustment is relevant only for those cars which plates have not been recognized. If the plate has not been recognized, the module gives as a result the frame located at the specified distance from the frame with first car appearance.

Note.

The moment of car appearance in the frame like as 0% and the moment of car disappearance in the frame like as 100%.

4. Set the **Full interval between cars** checkbox (3) in case if the recognizer is to be in a waiting state with motion absence in the whole frame. This adjustment can improve the quality of long vehicles recognizing in the frame (e.g. trucks).
5. Set the **Recognize license plates only in areas where motion is detected** checkbox (4) to increase the recognizing speed on mega-pixels video cameras.
6. Enter the value of minimal validity of recognition in percent in the **Minimum validity of LP recognition (60-100%)** field (5). Validity is defined by the degree of similarity between results of recognition and the LP template and it allows distinguishing the LP from other marks on the vehicle.

Note.

The validity is displayed in the List of parameters of the **Active monitor** box.

7. Set the **Obscured LPs** checkbox (6) to increase the quality of recognition the vehicles with obscured plates.
8. The non-editable **Number of lanes in camera field of view** field (8) displays the number of lanes captured by the **AUTO-Uragan** module.
9. Set the **Skip unrecognized LPs** checkbox (7) if it is necessary to ignore unrecognized numbers.
10. Set the **Allow** checkbox (9) to enable the possibility to recognize the two-line LPs.
11. Set the maximum width and height of area where the search of LPs is performed (is set in percent of the full frame) (10).

Click the button to set these parameters. In the **Two-line LPs** opened box click the **Stop video** button when the appropriate frame is appeared and select the area with the required size.

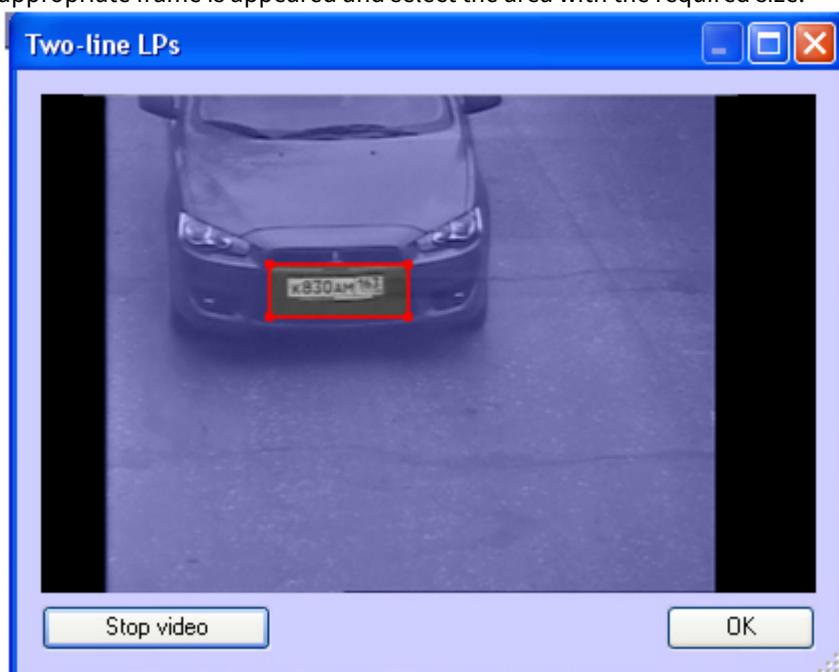

Click **OK** and the specified area parameters will be automatically entered in the **Maximum width** and **Maximum height** fields.

12. Set the minimal area width and height where the search of LP is performed (11) (is set in percent of the full frame) by analogy with the **Maximum width** and **Maximum height** parameters – see item 11.
13. In the **Current version** field (12), select the SDK version of the **AUTO-Uragan** module. SDK version **3.8** (default) is recommended.

Note

You can also change the SDK version using the batch files (see [Changing the SDK version using batch files](#)).

⚠ Attention!

After changing the SDK version, it is necessary to restart *Auto Intellect* to apply the changes.

14. Set the **Parallel** checkbox (13), if it is necessary to recognize a LP number simultaneously on several processors using parallel computing, which improves the performance of the **AUTO-Uragan** module.
15. In the **Number of CPUs** field (14), specify the number of processors which will be used for the parallel computing, if the **Parallel** checkbox is set.

i Note

Processors are physical and logical cores available on the Server. For example, if there are 8 cores available on the Server, and the **Number of CPUs** field value is set to 4, then only the cores from 1 to 4 will be involved in the LP numbers recognition.

16. The typical minimum size and the typical maximum size of plates recognized by **Auto-Uragan** program module will be correspondingly displayed in the **Typical minimum size** and **Typical maximum size** non-edited fields (15).

i Note.

Typical minimum size and **Typical maximum size** fields are not displayed if there are no recognized LPs.

i Note.

Typical minimum size and **Typical maximum size** fields are displayed only if the Debug 1-Debug 4 mode is enabled. The debug mode is described in the [Intellect software package.Administrator's Guide](#) document.

17. Click **Apply** to save the changes (16).

i Note

The parameters **Current version**, **Parallel**, and **Number of CPUs** will be applied to all activated **AUTO-Uragan** software modules in *Auto-Intellect*.

Setting up the **AUTO-Uragan** program module is completed.

5.2.4.4.1 Changing the SDK version using batch files

To enable the possibility of changing the versions of SDK, at the first start of *Intellect*, open the command line as an administrator, using it, go to the Modules64/UrmLpr/Auto_uragan/required SDK version/Bin folder and run the Regsvr32 UrmCom.dll command. After that, you can change the version of SDK both using the batch files and via the *Intellect* settings.

To change the SDK version of the **AUTO-Uragan** software module using the batch files, do the following:

1. Go to the <Auto Intellect installation directory>\Modules\UrmLpr\Auto_uragan folder.

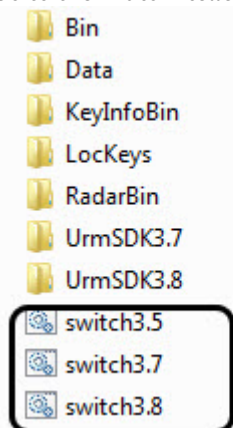

- Execute the **switch3.5.cmd** batch file to change the SDK version to **3.5** or the **switch3.7.cmd** file to change the SDK version to **3.7** or the **switch3.8.cmd** file to change the SDK version to **3.8**. As a result, a Windows command prompt window will open, where the information about the SDK version change status will be displayed.

```

C:\Windows\system32\cmd.exe
Register Urm.dll
Save to registry AutoUragan.SDKVersion = 3.5
The operation completed successfully.
The operation completed successfully.
Press any key to continue . . . _
  
```

Note

Press any key on the keyboard to close the Windows command window.

- Restart *Auto Intellect* to apply the changes.

Note

The SDK version will be changed for all **AUTO-Uragan** software modules in *Auto Intellect*.

Changing the SDK version of the **AUTO-Uragan** software module using the batch files is complete.

5.2.5 Bioiris

5.2.5.1 The Bioiris module functionality

The **Bioiris** software module supports the following functionality:

- Recognition of Chinese vehicle license plates only.
- Recording the recognized LP number into the license plate recognizer database.
- Determination and logging of the speed of the recognized vehicle into the database (using the **Speed traps server** module).
- Checking the recognized vehicle LP numbers against the connected wanted databases.
- Ability to work with a multi-lane road (recognition of up to 10 vehicle license plates in one frame).
- Recording frames of recognized license plates for debugging in bmp, jpeg and avi formats.

5.2.5.2 The Bioiris module licensing

The **Bioiris** software module is licensed in *Auto Intellect* using a *License.txt* license file. This file must be placed in the folder *<Auto Intellect installation directory>\Modules64\UrmLpr\BIOIRIS*.

5.2.5.3 Video camera mounting and setup requirements for the Bioiris software module

To ensure the recognition of the state license plates using the **Bioiris** software module, it is necessary to install and configure the video cameras in such a way that the following requirements are met:

Camera specifications	<ul style="list-style-type: none"> Basic characteristics of used video cameras are presented in the General requirements for mounting and configuring of cameras section.
Video image	<ul style="list-style-type: none"> The symbols height for IP cameras should be not less than 20-30 px, for analog cameras - not less than 14-20 px, the stroke width should be not less than 2 px; Minimum allowed contrast with evenly dirty number plate should not be less than 10% (the contrast differentiation of symbols to the background is 25 on 256 point scale); Maximum allowed uneven dirtiness is not more than 12% (ratio of the dirty area of the number plate to its whole area); Geometrical proportions of the number plate picture should not differ from such proportions of the number plate itself with more than 10%.
Camera positioning	<ul style="list-style-type: none"> The camera should be installed permanently

For correct license plate recognition, only China license plates should be installed on the vehicle. If the vehicle has both a China license plate and a Hong Kong and/or a Macau license plate, then the Chinese license plate may not be recognized correctly.

An example of a vehicle image, which license plate may not be recognized correctly:

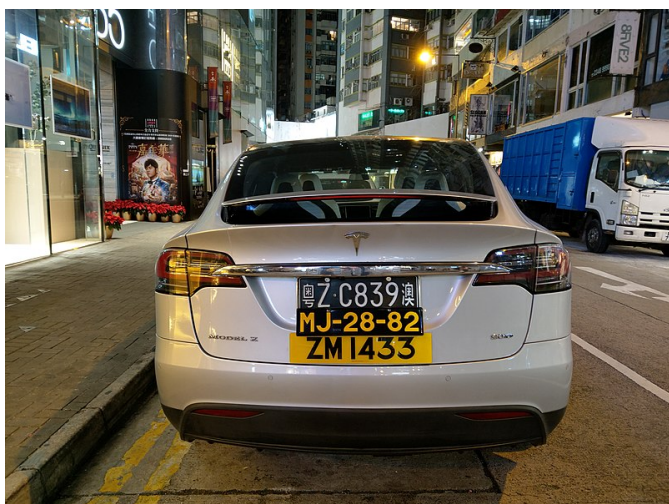

Attention!

Any deviation from the above requirements reduces the likelihood of correct number recognition.

5.2.6 CARMEN-Auto

5.2.6.1 The CARMEN-Auto module functionality

The **CARMEN-Auto** software module supports the following functionality:

1. License plates identification;
2. Saving the identified number to the plates detector database;
3. Identification and logging the determined speed of the vehicle to the plates database (by video or using the **Radar** module).

Note

The **CARMEN-Auto** software module also supports the parking mode, which is enabled using the **ParkingMode** registry key (for details, see [Registry keys reference guide](#), for more information about working with the registry, see [Working with Windows OS registry](#)).

By default, the recognition of all Latin license plate characters is used (for example, corresponding to countries such as Argentina, India, Africa and Singapore), although the country recognition function is not used.

To add additional recognition engines, you need to install the appropriate engines (for more information see [Setting up the CARMEN-Auto module](#)).

The full list of supported countries for **CARMEN-Auto** module and the personal settings for license plates recognition are available on request to technical support of the module manufacturer (AHR).

The missing countries can be added into the recognition module if necessary. For that, contact your AxxonSoft manager and provide him or her a video recording with license plates of the required country. The final decision on adding a country to the module is made by the module manufacturer.

5.2.6.2 CARMEN-Auto module licensing

The **CARMEN-Auto** software module uses the *Carmen FreeFlow* license type and is licensed by the used processor cores. There is additional electronic key in the form of USB key in case of license for one and two cores and in the form of PCI card in case of one, two and four cores. Number of recognition channels is limited by processor capacity. There are no restrictions on the number of recognitions per unit.

For the *Carmen FreeFlow* license type, it is possible to use multiple hardware keys of any type on the same PC. Even if two hardware keys of different types are used (the first is USB and the second is PCI).

5.2.6.3 Video camera mounting and setup requirements for the Carmen software module

To ensure the proper recognition of license plate numbers using the *Auto-Intellect* system, the angle between the camera axis and the direction of the vehicle movement is to be minimal.

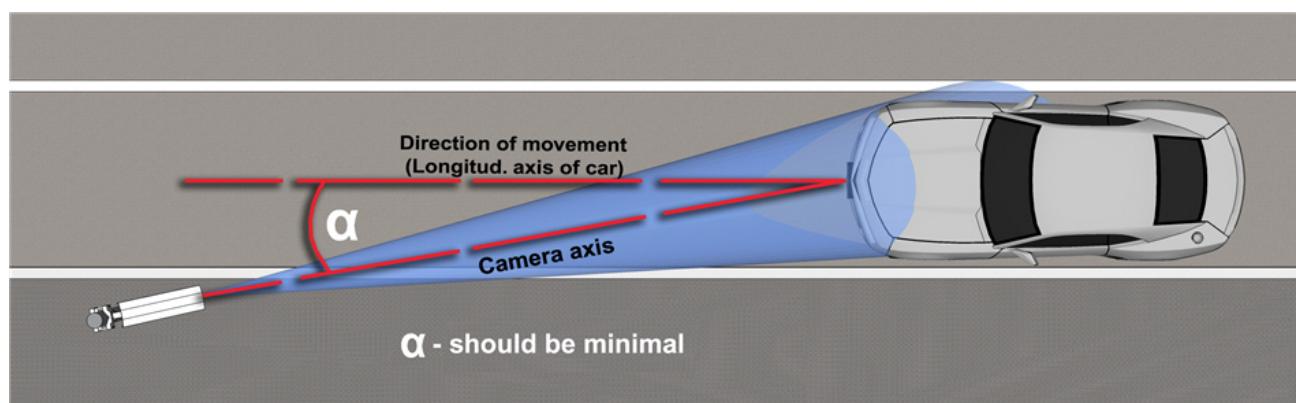

The camera is to be installed on the optimal distance from the plate. If the camera is too far from the plate, the characters may not be large enough for recognizing them. In this case zoom-in until you reach the proper size. If the distance is too short it may happen that a part of the plate is over the camera's field of view.



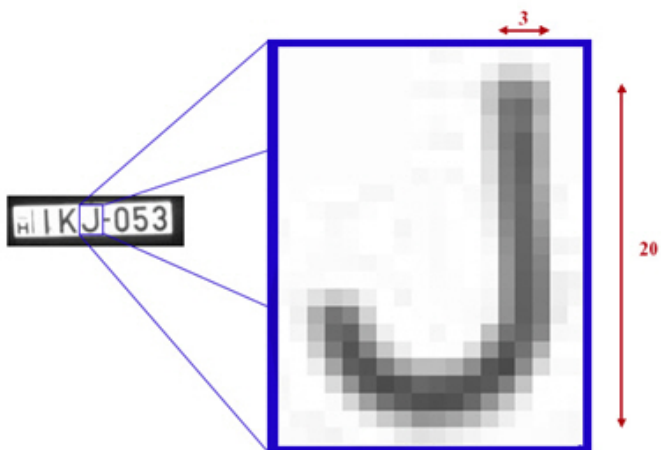

For recognition it is necessary to make sure that frames with number plates fulfill the following characteristics:



- height of latin symbols is not less than 16 px, line-width is not less than 2px;
- height of non-latin symbols is not less than 20 px, line-width is not less than 2px;
- optimal character height is around 16-30 px;
- character size is not greater than 50 px in height;
- symbols should be sharp, not smeared, undistorted, not overexposed, evenly lighted;
- symbols should be visually differentiated;
- license plate number should be fully placed in the frame.

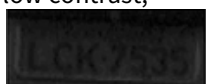
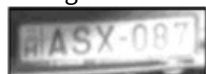

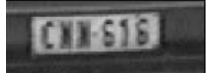
The following conditions may cause invalid results of LP recognition:

- low contrast;
 
- bad light conditions (shadow and strong light);
 
- high distortion;
 
- low spatial resolution;
 
- blurred image;
 

- interlaced.

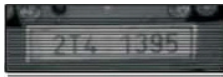

5.2.6.4 Setting up the CARMEN-Auto module

Attention!

To ensure the correct **CARMEN-Auto** module operation, do the following:

1. Make sure that "KB3033929" security update and [Hotfix](#) are installed.
2. If *Carmen GX* drivers are installed, then they should be uninstalled from Windows.
3. Make sure that there is not a single folder with any drivers left at C:\Windows\System32\DRVSTORE\ (if there are folders, they should be removed).
4. Restart the computer.
5. Download the *Carmen Freeflow 7.3.1* distribution kit from the [AxxonSoft](#) website and install it. If an older version was installed earlier, then it should be uninstalled before installing a newer version.
6. Download the distribution kit with the license plate recognition algorithm from the [AxxonSoft](#) website and install it via the *Engine Manager* utility. The procedure for installing the recognizer using the *Engine Manager* utility is described in the engine_install_windows.txt file located in the folder with the corresponding recognizer.

Setting up the **CARMEN-Auto** program module is performed in the following way:

1. Go to the **CARMEN Module** object settings panel, which is created on the basis of the **LPR Channel** object.

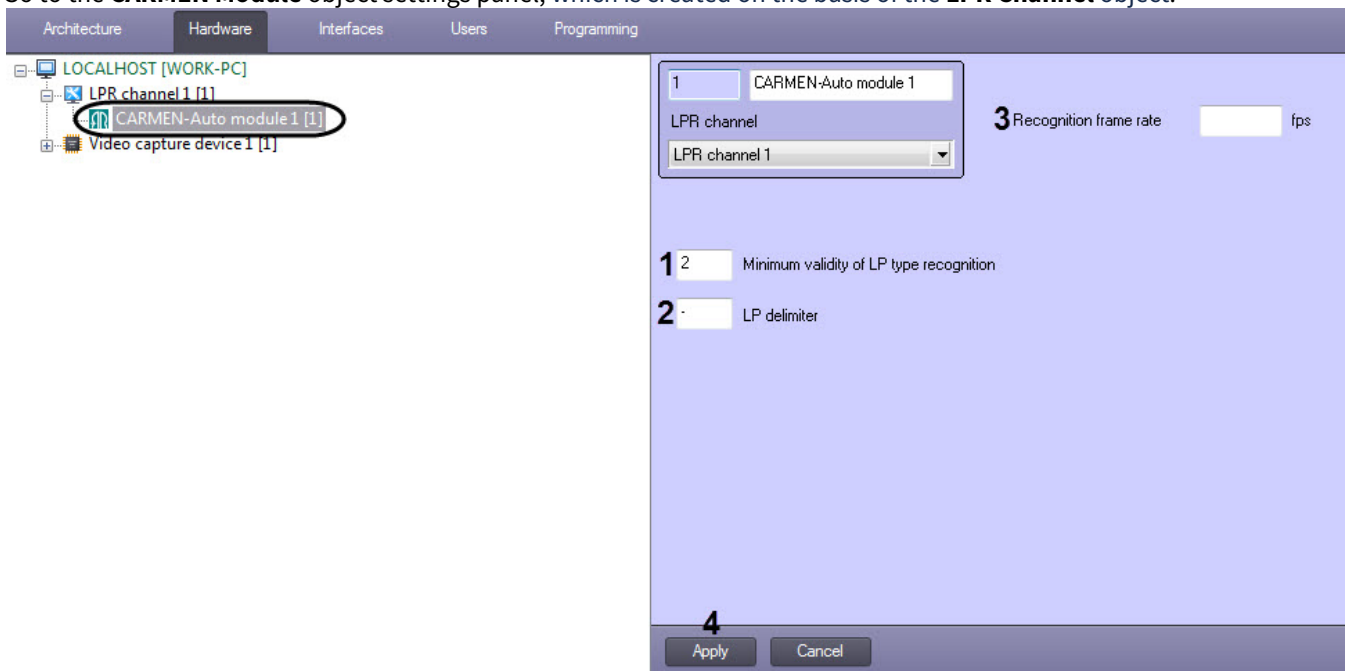

2. Enter the value of minimal validity of recognition in percent in the **Minimum validity of LP type recognition** field (1). Validity is defined by the degree of similarity between results of recognition and the LP template and it allows distinguishing the LP from other marks on the vehicle.

Note.

The validity is displayed in the List of parameters of the **Active monitor** box.

3. In the **LP delimiter** field (2) enter symbols which will separate LP symbols from region symbols. Maximum number of delimiter symbols – 2. If recognized license plate is to be written without any delimiters, leave the **LP delimiter** field empty.
4. In the **Recognition frame rate, fps** field (3), enter the number of frames per second processed by the recognizer. If you enter **0** or leave the field empty, the recognizer will process the maximum possible number of frames.

5. Click **Apply** to save the changes (4).

Setting up the **CARMEN-Auto** program module is completed.

For the best quality of recognition consider the following characteristic while the CARMEN-Auto configuring:

1. The less resolution the higher quality of recognition. It is recommended to use the following resolution: 320x240 - 800x600px. It is highly recommended not to use resolution more than 1.2 Mpx.
2. It is recommended to specify the search area. It results in decreasing of factual resolution which go to the entry on recognizer. The less area the less resolution and consequently the higher quality of recognizing.
3. It is recommended to use recognition by trigger command (motion detection, the Parking mode) instead of permanent recognition. If a lot of recognizers are to be configured on the one server, use the Parking mode. Detailed information about Parking mode is presented in the [Scripts used in the Auto-Intellect software package](#) section.
4. The less recognizers are created on the one computer the higher speed of video processing because the speed of video processing is shared between all created recognizers. Low speed of processing results in plate recognition delay and bad quality of recognition.

Here's approximate data of speed of video processing:

For the Common characters template:

Resolution	FPS
320x240	19
480x360	18
640x480	13
1024x768	8
1280x960	8

For other templates:

Resolution	FPS
320x240	12
480x360	9
640x480	7
1024x768	5
1280x960	4

Note.

These data can differ decreasingly of frequency of processed frames at different lighting conditions, on different processors etc.

5.2.7 CIDR IntelliVision

5.2.7.1 The functionality of the CIDR IntelliVision module

The **CIDR IntelliVision** module supports the following functionality:

1. Recognition of railway container license plates;
2. Recording the recognized license plate into the database;
3. Checking the recognized railway container license plates against the connected search databases;
4. Recording the frames of recognized license plates for debugging in bmp, jpeg and avi formats.

5.2.7.2 Licensing of the CIDR IntelliVision module

The **CIDR IntelliVision** module is licensed in *Auto Intellect* using a USB dongle.

5.2.7.3 Video camera mounting and setup requirements for the CIDR IntelliVision module

To ensure the correct recognition of the railway container license plates, follow the requirements listed below.

Requirements for video camera characteristics:

1. High definition cameras (720p recommended);
2. Recommended frame rate per second is 24;
3. The container motion speed must meet the camera operation speed. For a better recognition, it is necessary and it is enough to have 1-2 frames of a container number.
4. it should be possible to set a fixed exposure value (shutter) on video camera of 1/2000 s or less;
5. the video cameras should have high sensitivity (0,01 lx or more).

Requirements for video camera position:

1. The distance between the video camera and the carriage should be at least 1,5 meters (depends on the focal length of the camera lens), the optimal distance is 5-7 meters;

Note

To simplify the setting, it is recommended to use the varifocal lenses. The focal length variation range should be selected in each case of the system installation.

If you use the camera with an integrated lens with a focal length of 2.8 mm or less, then there may be strong geometric distortions on the image. As a result, the recognition quality may go down. To avoid this, it is necessary to use special removable lenses with an aspherical lens, which eliminate these distortions.

2. the cameras height for reading the side number is 3–3,5 meters, the cameras height for reading the chassis number is 1,5 meters;
3. the width of the carriage plate number in the image should be about 30-35% of the total image width, in most cases this means the width of the camera control zone is 3-5 meters;
4. the optical axis of video camera should be perpendicularly to plane of carriage plate;
5. the position of the carriage in the frame should be strictly horizontal;
6. the infrared sensor and the video camera should be located in the same vertical plane.

Note

If the analog video camera is used, then to prevent the video signal fading on the transmission line, it is necessary that the distance from the video camera to the digitizing device does not exceed 30 meters.

Image requirements:

1. the position of the container or wagon in the frame should be strictly horizontal;
2. the size of the number symbols on the image should be between 20 and 40 pixels, i.e. not less than 4% of the image height;
3. geometric distortions ("barrels", "pillows") introduced by the optics should be moderate.

Also it's required while video camera setup:

1. Focus camera exactly to the container or wagon plate;
2. It is recommended to turn off all the camera's smart features. For example, contrast adding mode.

Below is a diagram of the camera installation to ensure the most accurate recognition of license plates of freight containers.

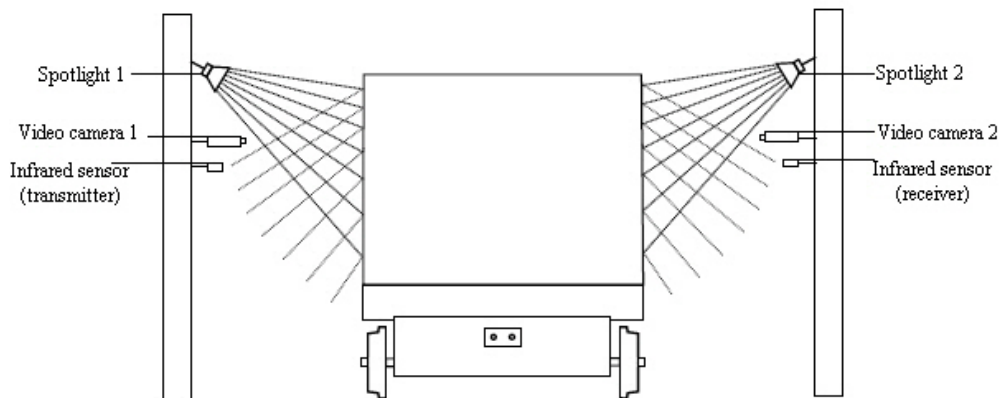

Reference image received from correctly mounted and setup video camera is shown in the following figure.



5.2.7.4 Configuring the CIDR IntelliVision module

Configure the **CIDR IntelliVision** module as follows:

1. Go to the settings of the **CIDR IntelliVision** module object created under the **LPR channel** object.

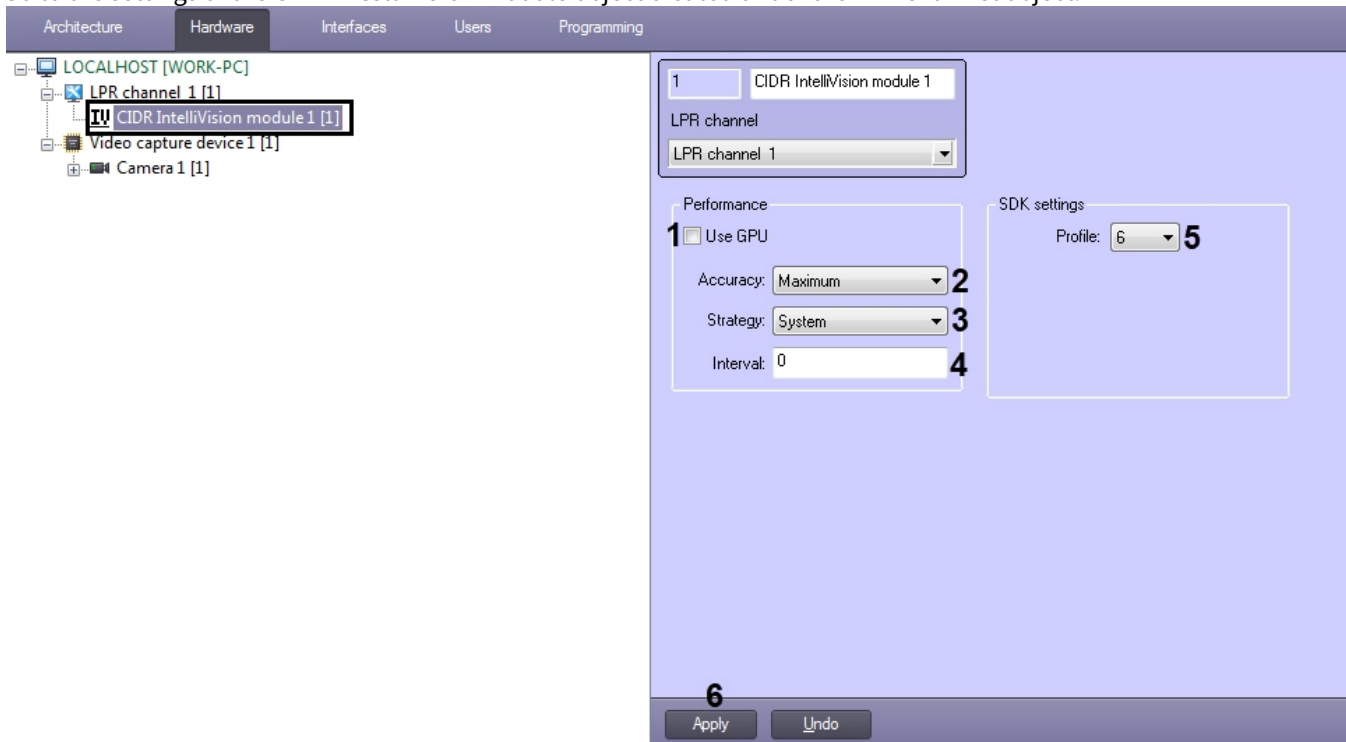

2. Set the **Use GPU** checkbox (1) if it is necessary to use the NVIDIA GPU resources to increase the license plate recognition performance. By default, only the CPU resources are used.

⚠ Attention!

The startup (initialization) of the license plate recognition algorithm on NVIDIA GPU can take about one minute. No LP recognition events will be received until the initialization is complete.

3. Select the numbers recognition accuracy in the **Accuracy** drop-down list (2). The following options are available:
 - a. Maximum — enables maximum recognition accuracy, but it causes great CPU and/or GPU load.
 - b. High — enables high recognition accuracy, it requires less computing resources than for maximum accuracy.
 - c. Fast — enables high recognition speed, but the accuracy becomes worse.
4. Select the computing resources use mode in the **Strategy** drop-down list (3). The following options are available:
 - a. Process — mild mode: no more than 1 core for 1 license plate.
 - b. System — default mode: all available computing cores are in use;
 - c. Core — strict mode: 1 core per stream.
5. In the **Interval** field (4), specify the minimum time interval in milliseconds that lasts between frames processing (i.e. all frames within this interval will not be processed). The range of values is 0-999, the default value is 0.
6. The **Profile** drop-down list (5) displays the license plate recognition quality profile. At the moment, only profile 6 is used, which provides high performance (high processing speed and low CPU usage).
7. Click **Apply** (6).

Configuration of the **CIDR IntelliVision** module is completed.

5.2.8 IntLab

5.2.8.1 The IntLab module functionality

The **IntLab** software module supports the following functionality:

1. Recognition of license plates of all types of railway carriages, platforms, tanks marked with a number conforming to the Ministry of Transport standard on board and/or chassis;
2. Recognition of license plates of all types of railway carriages, platforms, tanks marked with a number conforming to the International Union of Railways (UIC) standard on board and/or chassis;

3. Recognition of license plates of all types of railway containers with a number conforming to ISO 6346 standard on the roof and sides of the container;
4. Determination of the direction of movement of all the above types of railway carriages, platforms, tanks, and containers, and logging it to the database.
5. Saving the identified number to the plates detector database;
6. Verifying the license plate recognition by the checksum and recording the verification result in the database.

Characteristics of the **IntLab** software module:

Mode	Recognition of passenger and cargo railway carriage numbers (conforming to the Ministry of Transport standard)	Recognition of railway carriage numbers conforming to the UIC standard	Recognition of railway container numbers	Note
LP number recognition accuracy	up to 97%	up to 97%	up to 97%	LP number recognition accuracy depends on the following factors: compliance with recommendations for choosing, installing and configuring equipment, the accuracy of the recognition module settings, recognition from one or two sides of the car, recognition from a separate image or the video stream.
Time of one frame recognition	5-40 ms	20-300 ms	20-300 ms	Frame recognition time depends on the computing power of the equipment, the frame resolution and image complexity, which consists of the following factors: the noise in the form of text inscriptions not related to the car number, the damages on the number, the number correspondence to the standard, the complexity of lighting — shade and light in the car number area, etc.
Maximum train speed	80 km/h	20 km/h	20 km/h	The indicated speed applies if the standard equipment is used. The maximum allowable train speed depends on the camera fps number, the distance from the camera to the car and the average frame processing time.
Supported types	Locomotive, open box car, hopper, tank, covered train car, automobile car, refrigerator, dumping car, platform and any others that have a number conforming to the Ministry of Transport standard.	Locomotive, passenger car, open box car, hopper, tank, covered train car, automobile car, refrigerator, dumping car, platform and any others that have a number conforming to the UIC standard.	Dry cargo containers 20, 40, 45, 48, 53 feet long, tank containers 20 feet on a railway platform or on a truck trailer	-

5.2.8.2 IntLabs module licensing

Licensing of the **IntLab** program module is performed by USB-key.

5.2.8.3 Video camera mounting and setup requirements for the IntLab module

Requirements for video camera characteristics:





1. It is recommended to use the resolution of no more than 800x600;
2. Recommended frame rate per second is 25;
3. High resolution black and white cameras are recommended because they provide better quality of image at low light conditions;
4. If the analog video camera is used, then to prevent the video signal fading on the transmission line, it is necessary that the distance from the video camera to the digitizing device does not exceed 30 meters;
5. It is recommended to use a camera and a lens with auto iris support to minimize the number of flares and maintain optimal frame contrast.

Image requirements:

1. The geometric distortion by optics ("barrels" and "pillows") should be reduced;
2. The image of the carriage plate numbers should be clear, contrast and readable;
3. It is recommended to disable all the camera functions aimed for processing dark areas of bright images, brightness, color tone, contrast, etc, because these functions usually degrade image quality due to the heavy traffic and sudden changes in light which often occur in the control zone when recognizing railway container and carriage numbers.

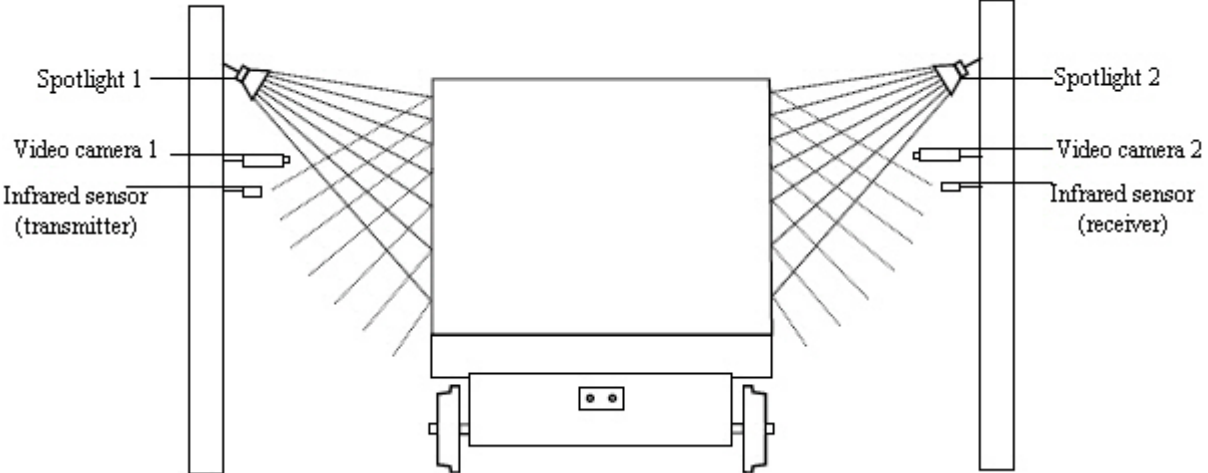
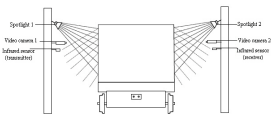
Requirements for video camera installation:

-	Passenger railway carriages	Cargo railway carriages	UIC railway carriages	Railway containers
Supported character size	At least 10 pixels; >= 16 pixels are recommended			
Possible places for reading numbers	carriage number	carriage number, number on the chassis	carriage number, number on the chassis	roof and sides of container
Number of control cameras	1-2; 2 are recommended	1-4; at least 2 are recommended; 4 – if there are platforms	1-4; at least 2 are recommended; 4 – if there are platforms	1-6; at least 2 are recommended
Width of camera control zone	5-10 meters	5-10 meters	5-10 meters	4-8 meters
Camera horizontal angle	<= 20°			
Camera vertical angle	<= 30°			
Camera angle of view	<= 5°			
The camera height relative to the top of the railroad tracks	3-3.5 meters	3-3.5 meters for reading the side numbers, 1.5 meters for reading the chassis number	1.7-2.3 meters	2.5-3.4 meters
Distance between the camera and the carriage	1,5-10 meters (depends on the focal length of the camera lens), the optimal distance is 4-6 meters	1,5-10 meters (depends on the focal length of the camera lens), the optimal distance is 5-7 meters	1,5-10 meters (depends on the focal length of the camera lens)	1,5-10 meters (depends on the focal length of the camera lens)
	<p>To simplify the setting, it is recommended to use the varifocal lenses. The focal length variation range should be selected in each case of the system installation.</p> <p>If you use the camera with an integrated lens with a focal length of 2.8 mm or less, then there may be strong geometric distortions on the image. As a result, the recognition quality may go down. To avoid this, it is necessary to use special removable lenses with an aspherical lens, which eliminate these distortions.</p>			

-	Passenger railway carriages	Cargo railway carriages	UIC railway carriages	Railway containers
<p>Minimum required lighting of a number</p>	<p>Depends on the camcorder used; typical value is 50 lux. To illuminate the control zone at night, it is recommended to use LED lamps with a direction zone of maximum light intensity of about 90 degrees.</p> <p>You can use a typical halogen spotlight with a capacity of 1–1,5 kW if the spotlight is mounted in distance 5-7 meters from the railway. Locate the spotlight as shown in the figure below. Such location allows to avoid the following:</p> <ol style="list-style-type: none"> 1. blindness of camera by spotlight directed to it from another side of railway; 2. image flashing by light reflection from the carriage. 			
<p>Example of successfully recognized numbers</p>				

5.2.8.4 Setting up the IntLab module

⚠ Attention!

To ensure the proper operation of the **IntLab** software module, additionally download and install the appropriate LP number recognition algorithms (SDK) from the [official AxxonSoft website](#). If the IntLab SDK was installed in a non-default folder, then for the **IntlabSDKx32Path** registry key (if the SDK x32 was installed), or **IntlabSDKx64Path** key (if the x64 SDK was installed), set the corresponding path to the folder in which the IntLab SDK was installed (for more details, see [Registry keys reference guide](#), for more information about working with the registry, see [Working with Windows OS registry](#)).

Setting up the **IntLab** program module is done in the following way:

1. Go to the **IntLab module** object settings panel, which is created on the basis of the **LPR Channel** object.

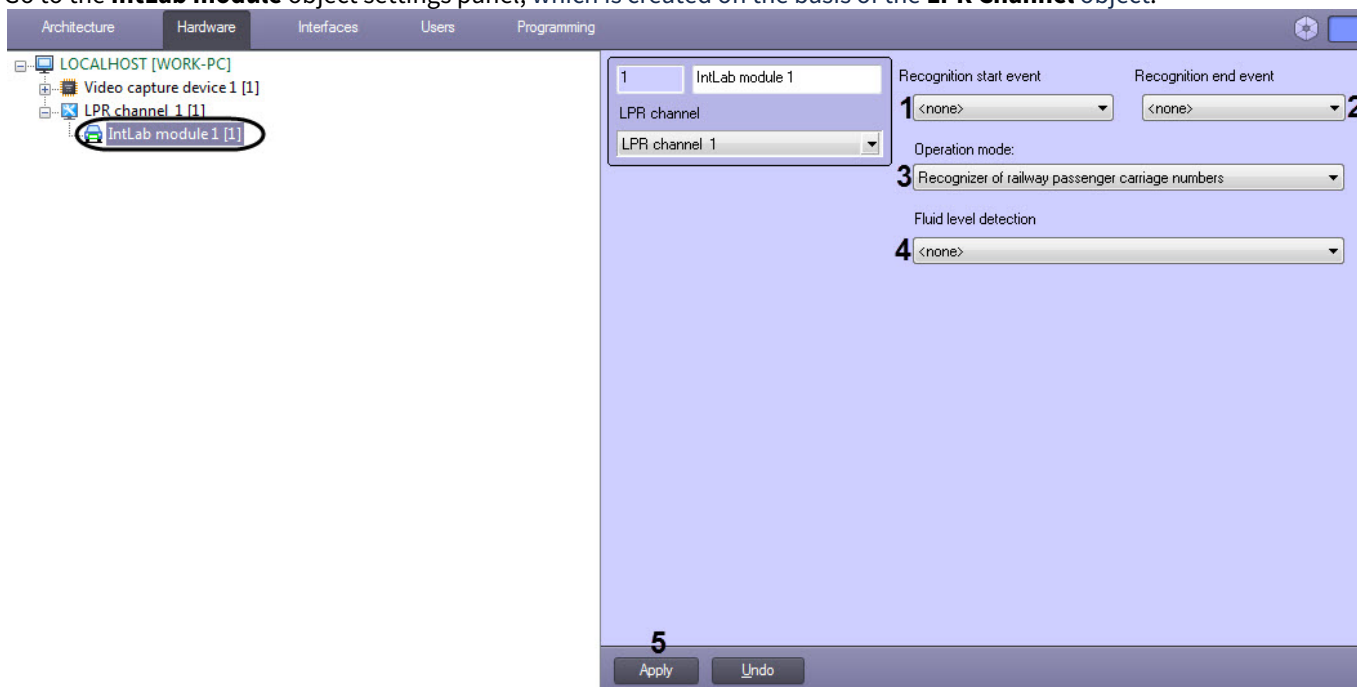

2. Select the macro from the drop-down list of the **Recognition start event (1)** on which the LP recognition will be started.

Note

LP number recognition may also start with the subtitles information added to a video. To do so, it is necessary to specify the **1** value for the **ReadRayFromTitles** registry key (for more details, see [Registry keys reference guide](#), for more information about working with the registry, see [Working with Windows OS registry](#)).

3. Select the macro from the drop-down list of the **Recognition end event (2)** on which the LP recognition will be completed and the result will be given.

Note

For more details on working with macros, see [Creating and using macros](#).

4. From the **Operation mode** drop-down list select the mode of numbers recognition (**3**).

Mode
Recognizer of railway passenger carriage numbers
Recognizer of railway freight carriage numbers
Recognizer of UIC railway carriage numbers
Railway container number recognizer

5. From the **Fluid level detection** drop-down list select the **Fluid level detection** object to be used with the **IntLab** module (**4**). Fluid level detection is a part of the *Intellect Detector Pack* subsystem starting from version 2.6. For details on how to create, configure and operate it, please refer to *Detector Pack. User Guide* (the most relevant version is available in [AxxonSoft documentation repository](#)).

6. Go to the parent **LPR Channel** object settings panel (see [Selecting the traffic direction for LP number recognition](#)) and select the **carriage** or **container** direction in the camera view:

- a. **any**: license plates are recognized for carriages moving in both directions;
- b. **to the right**: license plates are recognized for carriages moving to the right;
- c. **to the left**: license plates are recognized for carriages moving to the left.

7. Click **Apply (5)** to save changes.

If the use of the auxiliary recognition channels (**IntLab** subordinate modules) is required, the auxiliary channels are to be configured (see [Setting up the auxiliary recognition channel of the IntLab module](#)).

Note

By default, the **IntLab** module uses a standard frame issuing mechanism which may rarely not issue the license plate number with a better visibility. To enable the advanced frame issuing mechanism with a better visibility, which causes a temporary delay in getting the result, it is necessary to specify the **1** value for the **Intlab.BestFrame** registry key (for more details, see [Registry keys reference guide](#), for more information about working with the registry, see [Working with Windows OS registry](#)).

Setting up the **IntLab** program module is completed.

Note

When the *Auto-Intellect* software is restarted for the first time after configuring the **IntLab** module, the folder will be created on the following address:

- for x32: <Auto-Intellect installation directory>\Modules\UrmLpr\intlabinstlab_railway_detector\id
 - for x64: <Auto-Intellect installation directory>\Modules64\UrmLpr\intlabinstlab_railway_detector\id
- where id is the object identifier of the **LP recognition channel**.

This folder will contain the following files and folders:

1. **settings.json** is the file containing initial settings of the **IntLab** module.
2. **settings_override.json** is the file containing modified settings which can be edited manually.
3. **settings_merge.json** is the file containing the merge result of the above mentioned files. There are parameters displayed in this file which are directly used by the **IntLab** module.
4. The folders with the **IntLab subordinate module** object identifiers name, if they exist (see [Setting up the auxiliary recognition channel of the IntLab module](#)), containing similar files but having the settings of the corresponding **Intlab** subordinate module.

5.2.8.4.1 Setting up the auxiliary recognition channel of the IntLab module

The auxiliary channel for recognition of the carriages plates for the **IntLab** module can be used in the following cases:

- The same plate is placed on both sides of a carriage. If the plate cannot be recognized from one side (it is wiped off or dirtied, or the camera was blinded at the moment of plate fixation, etc.), the auxiliary channel from other side is utilized for plate fixation.
- Carriages of different types pass through the recognition point, e.g. platforms and hoppers. Sometimes one camera isn't able to capture plates on all types of carriages (some plates are too high, some are too low). In this case two cameras can be placed on both sides of the railway track: one of them as a primary one and the other three as auxiliary.

Setting up the auxiliary channel for recognition of the carriages plates for the **IntLab** module is performed as follows:

1. Go to the **IntLab subordinate module** object settings panel, which is created on the basis of the **IntLab module** object.

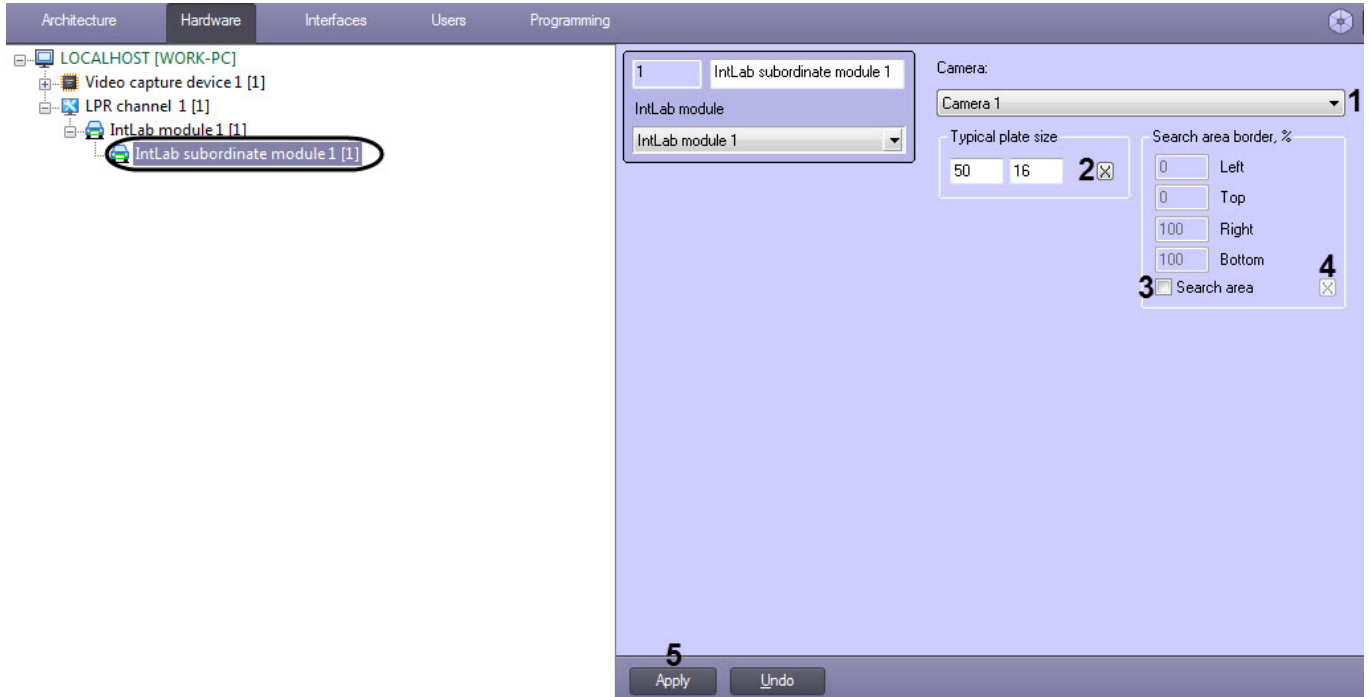

2. From the **Camera** drop-down list select the required **Camera** object, used for carriage plates recognition (1).
3. In the **Typical plate size** enter the width and height of recognized carriage plate (is set in pixels) (2).

To specify a plate size in the video image using a mouse button, do the following:

- a. Click the button to open the **Camera** window. The **Camera** window displays video image from the camera set in the LPR channel settings.

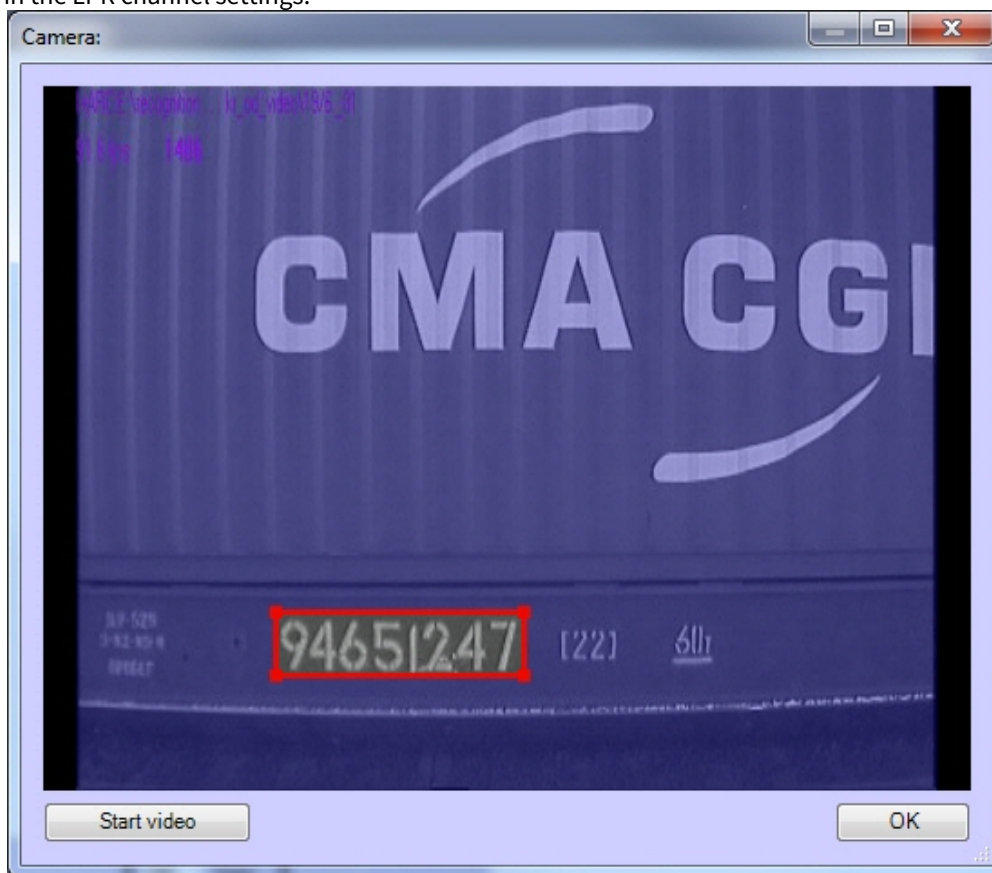

⚠ Important!

- Select 8 character cells for proper recognition of Russian carriages plates.
- Select 5 character cells for proper recognition of European carriages plates.



- b. Click and hold the mouse button in the video image at one of the corners of the supposed search area.
- c. Keep the mouse button pressed and drag the mouse across the supposed search area to the opposite corner. Release the mouse button and click **OK** button to save the selected area.

⚠ Attention!

For correct recognition of double-row plates (e.g. plates of passenger carriages) specify size of one row in the **Typical plate size:** field.



- Set the **Search area** checkbox to activate function of specifying search area borders in the video image (3).

Note.

Procedure of specifying search area borders in the video image using mouse button is the same as procedure of specifying plate size (see item 3).

- In the **Left, Top, Right, Bottom** fields enter values of search area border of carriage plate in the video image (4). Values of the search area borders are specified in percentage of the video image size.
- To set the values of the search area borders for the railway car license plate, left-click the  button in the video frame (4).
- To save changes click **Apply** (5).

Setting up the auxiliary channel for recognition of the carriages plates for the **IntLab** module is completed.

5.2.8.4.2 Setting up display of information on fluid level in search results for the IntLab module

Set up the displaying of information on fluid level in search results for the **IntLab** module as follows:

1. Open the **Event search in the Recognition DBs** dialog box (see [Using the Vehicle Tracer interface object](#)).

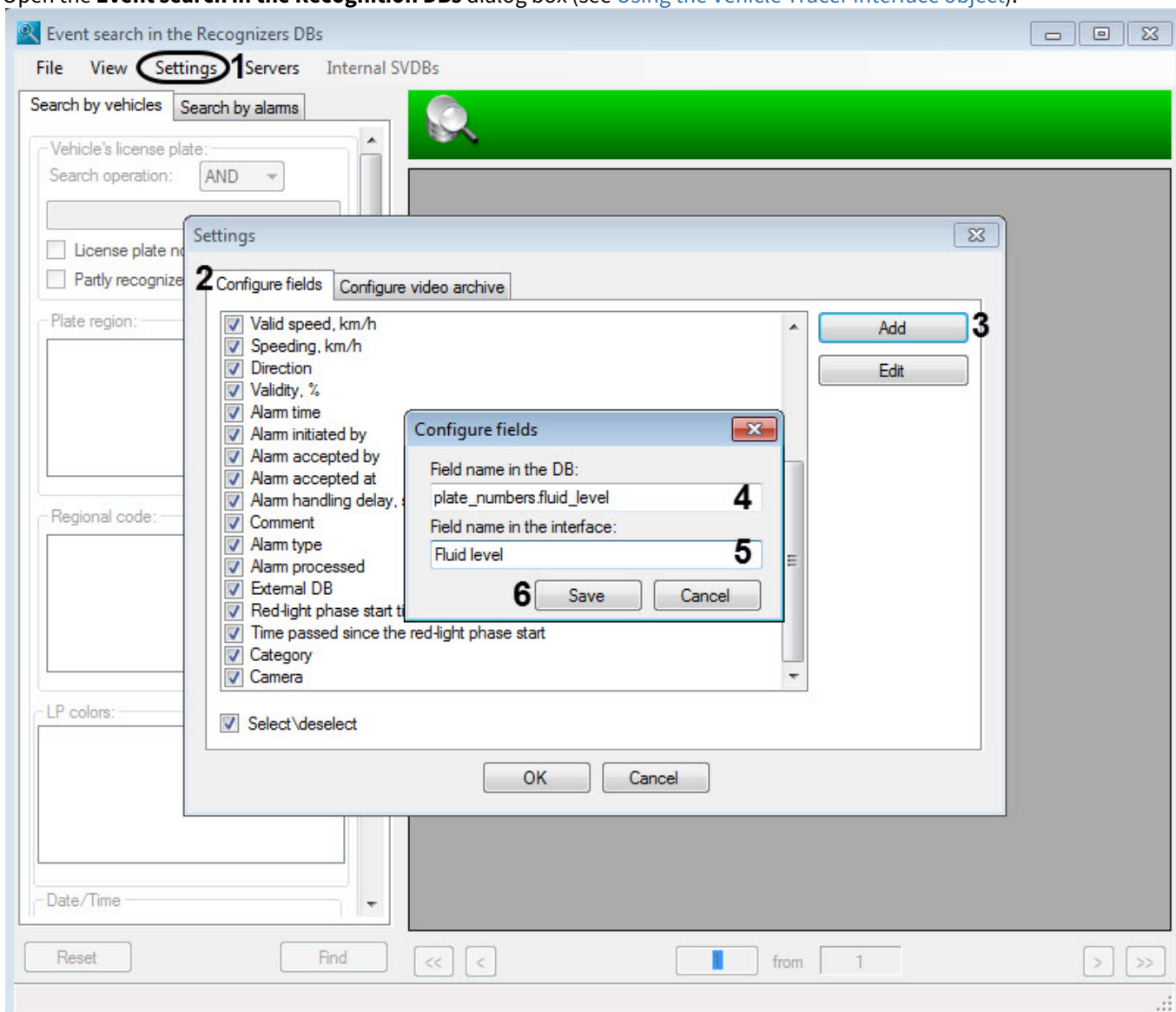

2. Go to the **Settings** (1). As a result the **Settings** dialog box appears.
3. Go to the **Configure fields** tab (2) and click the **Add** button (3). As a result the **Configure fields** dialog box appears.
4. Specify the **plate_numbers.fluid_level** value in the **Field name in the DB** field (4).
5. Specify the **Fluid level** value in the **Field name in the interface** field (5).
6. Click the **Save** button (6).

- In the **Settings** box of the **Configure fields** tab set the **Fluid level (7)** checkbox checked next to the added field in order to display this field in the event search results table.

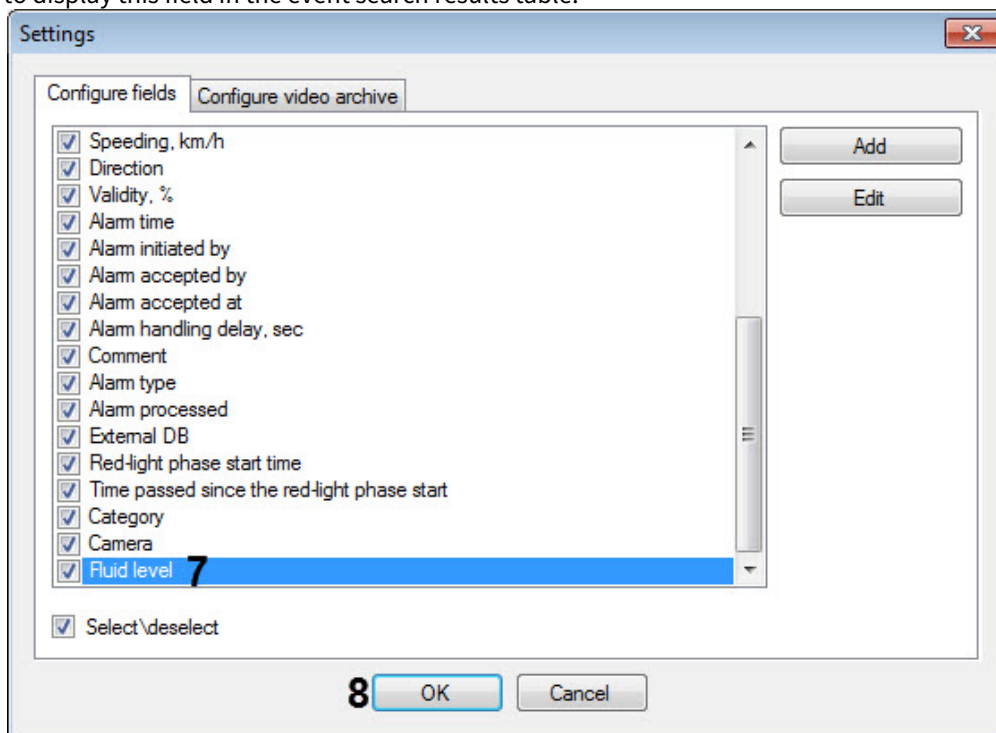

- Click the **OK** button (8).

Displaying of information on fluid level in search results for the **IntLab** module is now set up.

5.2.9 LPR IntelliVision

5.2.9.1 The LPR IntelliVision module functionality

The **LPR IntelliVision** software module supports the following functionality:

- Recognition of vehicle license plates.
- Saving the identified number to the plates detector database.
- Check of recognized license plates of vehicles via connected search databases.
- Recognition of an extended list of vehicle license plate types, including the main types of single-line numbers of different countries are supported, both civil and specialized (diplomatic, transit, military, etc.):

Country	Comment	Profile (see Setting up the LPR IntelliVision module)
Africa	The Republic of South Africa	6 (recommended), 9
Australia	-	6 (recommended), 9
Belarus	-	6 (recommended), 9
Brazil	-	6 (recommended), 9
Canada	-	6 (recommended), 9
China	-	6 (recommended), 9
Dubai	Dubai (emirate of UAE)	6 (recommended), 9
Egypt	-	6 (recommended), 9

Country	Comment	Profile (see Setting up the LPR IntelliVision module)
Europe	The template that includes the countries: Germany, Austria	6
France	-	6 (recommended), 9
Germany	-	6 (recommended), 9
Great Britain	-	6 (recommended), 9
India	-	6 (recommended), 9
Indonesia	-	6 (recommended), 9
Israel	-	6 (recommended), 9
Japan	-	6 (recommended), 9
KZ, UA, BY, RU	The template that includes the countries: Kazakhstan, Ukraine, Belarus, Russia	6 (recommended), 9
Kazakhstan	-	6 (recommended), 9
Malaysia-Singapore	-	6 (recommended), 9
Mexico	-	6 (recommended), 9
Middle East	-	6 (recommended), 9
North America	-	6 (recommended), 9
Poland	-	6 (recommended), 9
Qatar	-	6 (recommended), 9
Russia	-	6 (recommended), 9
Saudi Arabia	The Kingdom of Saudi Arabia	6 (recommended), 9
South Korea	-	6 (recommended), 9
Spain	-	6 (recommended), 9
Sri Lanka	-	6
Taiwan	-	6 (recommended)
Thailand	-	6 (recommended), 9
Turkey	-	6 (recommended), 9
UAE	United Arab Emirates	6 (recommended), 9
USA	The United States of America	6 (recommended), 9
Ukraine	-	6 (recommended), 9
Vietnam	-	6 (recommended), 9

5. Recording the frames with recognized numbers in .bmp, .jpeg and .avi formats for debugging.

5.2.9.2 LPR IntelliVision module licensing

The **LPR IntelliVision** module licensing in the *Auto Intellect* software is performed by processed video channels.

Contact *AxxonSoft* managers to get the **LPR IntelliVision** license.

The received *IntelliVisionLPRlicense.txt* license file is a software key, and it is assigned to the computer hardware. Add it to the folder at: *<Intellect installation folder>\Modules64*.

5.2.9.3 Video camera mounting and setup requirements for the LPR IntelliVision software module

To ensure the vehicle license plates recognition with the **LPR IntelliVision** software module, install and configure cameras so that the following requirements are met:

Camera specifications	<ul style="list-style-type: none"> the minimum video resolution of 640x480, the recommended resolution of 720p or 1080p; the minimum frame rate of 15 fps, the recommended frame rate of 25-30 fps; autofocus and zoom features are advisable to enable small changes after recognizer's configuration; automatic white-balance / automatic gain control; high-contrast IR for night mode; HDR / WDR.
Video image	<ul style="list-style-type: none"> the video image must be clear and contrast, without aberration; the size of the license plate must be 10-70% of the total frame size; there should be single or two-row of symbols on a license plate.
Camera positioning	<ul style="list-style-type: none"> the camera is to be 0,6-2,4 meters above the ground; the angle between the license plate bottom border and the horizon line should be of 0 to 20 degrees.
Vehicle speed	<ul style="list-style-type: none"> slow to moderate (8-40 kmph).

 **Note**

Current license plate recognition algorithm works only with alphanumeric symbols (A-Z, 0-9). In some countries specific letters on a license plate can be displayed as * after recognition.

 **Note**

For the examples of correct and incorrect video images, see [Appendix 8. Examples of correct and incorrect video images for the IntelliVision software module](#).

 **Important!**

It is also recommended to study the [manufacturer's specification](#).

5.2.9.4 Setting up the LPR IntelliVision module

Configure **LPR IntelliVision** module as follows:

1. Go to the settings of the **LPR IntelliVision** module object created under the **LPR channel** object.

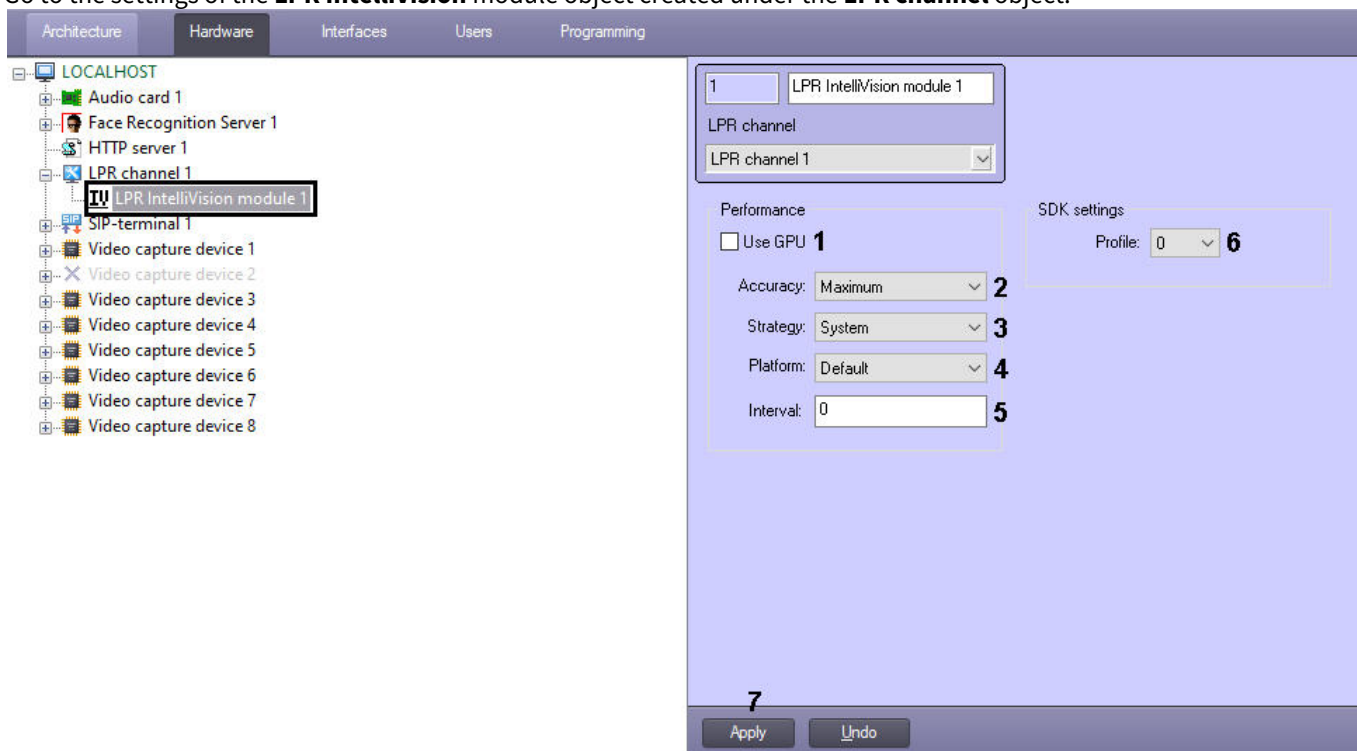

2. Set the **Use GPU** checkbox (1) if it is necessary to use the NVIDIA GPU resources to increase the license plate recognition performance. By default, only the CPU resources are used.

Attention!

The startup (initialization) of the license plate recognition algorithm on NVIDIA GPU can take about one minute. No LP recognition events will be received until the initialization is complete.

3. Select the LPR accuracy in the **Accuracy** drop-down list (2). The following options are available:
 - a. Maximum — enables maximum recognition accuracy, but it causes great CPU and/or GPU load.
 - b. High — enables high recognition accuracy, it requires less computing resources than for maximum accuracy.
 - c. Fast — enables high recognition speed, but the accuracy becomes worse.
4. Select the computing resources use mode in the **Strategy** drop-down list (3). The following options are available:
 - a. Process — mild mode: no more than 1 core for 1 license plate.
 - b. System — default mode: all available computing cores are in use;
 - c. Core — strict mode: 1 core per stream.
5. From the **Platform** drop-down list (4) select the device on which the module will operate:
 - a. Default — CPU resources are used for computing.
 - b. TensorRT — NVIDIA GPU resources are used for computing.
 - c. CV22, NCNN, HISI, Qualcomm, TFLite, OpenVino - other device resources are used for computing, if available. These options apply to platforms other than x86/x64.
6. In the **Interval** field (5), specify the minimum time interval in milliseconds that lasts between frames processing (i.e. all frames within this interval will not be processed). The range of values is 0-999, the default value is 0.
7. Select the profile of country license plates that are to be recognized in the **Profile** drop-down list (6).

Important!

The profile of country license plates should match the selected country for plate recognition (see [Selecting the country and license plate recognition SDK](#)).

The following options are available:

- 0 - Common. This profile should be selected if **By default** country is selected.
- 3, 6 and 9 — for more information see [The LPR IntelliVision module functionality](#) section.

Note

- The **9** profile enables recognizing correctly USA license plates with vertical letters on the plates. It can also be recommended to be in use when maximum recognition accuracy is needed if there is no high load on hardware.
- Greater profile number enables more accurate LPR comparing to the solution with smaller number, but it is more demanding to computing resources.

8. Click **Apply (7)**.

Configuration of the **LPR IntelliVision** module is completed.

5.2.10 RIDR IntelliVision

5.2.10.1 The functionality of the RIDR IntelliVision module

The **RIDR IntelliVision** module supports the following functionality:

1. Recognition of railway car license plates;
2. Recording the recognized license plate into the database;
3. Checking the recognized railway car license plates against the connected search databases;
4. Recording the frames of recognized license plates for debugging in bmp, jpeg and avi formats.

5.2.10.2 Licensing of the RIDR IntelliVision module

The **RIDR IntelliVision** module is licensed in *Auto Intellect* using a USB dongle.

5.2.10.3 Video camera mounting and setup requirements for the RIDR IntelliVision module

To ensure the correct recognition of the railway carriage license plates, follow the requirements listed below.

Requirements for video camera characteristics:

1. It is recommended to use the resolution of no more than 800x600, because using a resolution of more than 800x600 does not lead to the recognition quality improvement;
2. High resolution black and white cameras are recommended because they provide better quality of image at low light conditions;
3. Recommended frame rate per second is 24;
4. The carriage motion speed must meet the camera operation speed. For a better recognition, it is necessary and it is enough to have 1-2 frames of a carriage number.
5. it should be possible to set a fixed exposure value (shutter) on video camera of 1/2000 s or less;
6. the video cameras should have high sensitivity (0,01 lx or more).

Requirements for video camera position:

1. The distance between the video camera and the carriage should be at least 1,5 meters (depends on the focal length of the camera lens), the optimal distance is 5-7 meters;

Note

To simplify the setting, it is recommended to use the varifocal lenses. The focal length variation range should be selected in each case of the system installation.

If you use the camera with an integrated lens with a focal length of 2.8 mm or less, then there may be strong geometric distortions on the image. As a result, the recognition quality may go down. To avoid this, it is necessary to use special removable lenses with an aspherical lens, which eliminate these distortions.

2. the cameras height for reading the side number is 3–3,5 meters, the cameras height for reading the chassis number is 1,5 meters;
3. the width of the carriage plate number in the image should be about 30-35% of the total image width, in most cases this means the width of the camera control zone is 3-5 meters;

4. the optical axis of video camera should be perpendicularly to plane of carriage plate;
5. the position of the carriage in the frame should be strictly horizontal;
6. the infrared sensor and the video camera should be located in the same vertical plane.

Note

If the analog video camera is used, then to prevent the video signal fading on the transmission line, it is necessary that the distance from the video camera to the digitizing device does not exceed 30 meters.

Image requirements:

1. The minimum character height in the frame should be 16 pixels, 20–50 pixels are recommended; the line width of the character should be at least 2-3 pixels;

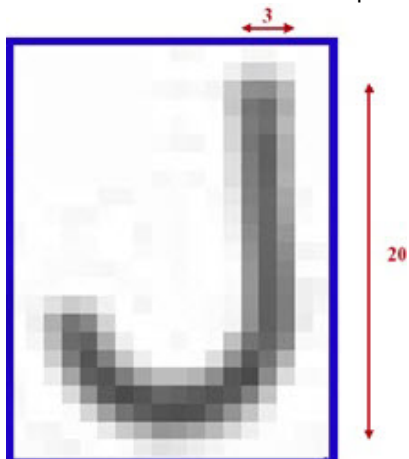

2. the geometric distortion by optics ("barrels" and "pillows") should be reduced;
3. the image of the carriage plate numbers should be clear, contrast and readable.

Also it's required while video camera setup:

1. Focus camera exactly to the carriage plate;
2. disable AGC mode in video camera;
3. disable modes of adding contrast of video camera.

To provide working of system at night use searchlight flashing of carriages/cisterns. Use usual halogen spotlight with a capacity of 1–1,5 kW while mounting spotlight in distance 5-7 meters from railway. Locate spotlight as shown in the figure below. Such location allows to avoid the following:

1. Blindness of camera by spotlight directed to it from another site of railway.
2. Image flashing by light reflection from carriage.

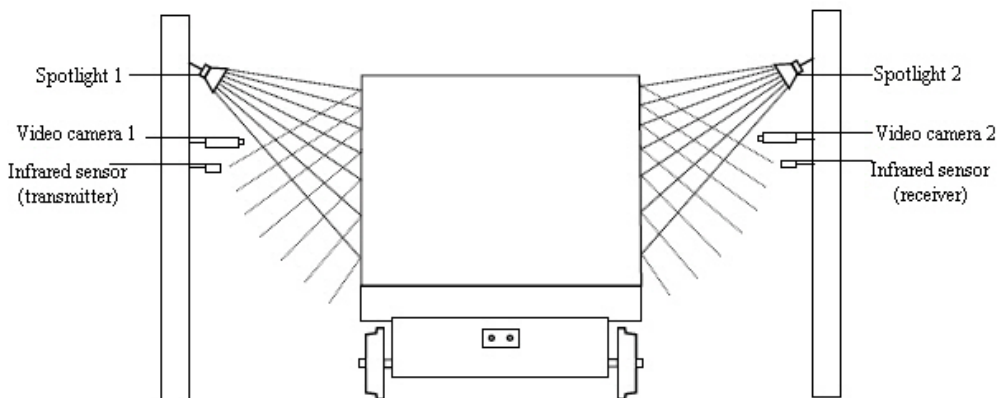

Reference image received from correctly mounted and setup video camera is shown in the following figure.



5.2.10.4 Configuring the RIDR IntelliVision module

Configure the **RIDR IntelliVision** module as follows:

1. Go to the settings of the **RIDR IntelliVision** module object created under the **LPR channel** object.

2. Set the **Use GPU** checkbox (1) if it is necessary to use the NVIDIA GPU resources to increase the license plate recognition performance. By default, only the CPU resources are used.

⚠ Attention!

The startup (initialization) of the license plate recognition algorithm on NVIDIA GPU can take about one minute. No LP recognition events will be received until the initialization is complete.

3. Select the numbers recognition accuracy in the **Accuracy** drop-down list (**2**). The following options are available:
 - a. Maximum — enables maximum recognition accuracy, but it causes great CPU and/or GPU load.
 - b. High — enables high recognition accuracy, it requires less computing resources than for maximum accuracy.
 - c. Fast — enables high recognition speed, but the accuracy becomes worse.
4. Select the computing resources use mode in the **Strategy** drop-down list (**3**). The following options are available:
 - a. Process — mild mode: no more than 1 core for 1 license plate.
 - b. System — default mode: all available computing cores are in use;
 - c. Core — strict mode: 1 core per stream.
5. In the **Interval** field (**4**), specify the minimum time interval in milliseconds that lasts between frames processing (i.e. all frames within this interval will not be processed). The range of values is 0-999, the default value is 0.
6. From the **Profile** drop-down list (**5**) select a license plate recognition quality profile:
 - **6** — provides higher performance (higher processing speed and less CPU usage) relative to profile **9**, but has a lower recognition accuracy.
 - **9** — provides higher recognition accuracy (works well on noisy and complex scenes) relative to profile **6**, but has lower performance (lower processing speed and more CPU consumption).
7. Click **Apply** (**6**).

Configuration of the **RIDR IntelliVision** module is completed.

5.2.11 RoadAR

5.2.11.1 The RoadAR module functionality

The **RoadAR** software module supports the following functionality:

1. License plates recognition.
2. Saving the recognized number to the plates detector database.
3. Identification and logging the determined speed of the vehicle to the license plates database (by video or using the **Speed traps server** module).
4. Check of recognized license plates via connected search database.
5. Possibility to work with multi-lane driveway (recognition of up to 10 vehicle license plates in one frame).
6. Saving the frames of the recognized license plates for debugging in bmp, jpeg and avi formats.
7. Recognition of an extended list of vehicle license plate types:
 - Armenia
 - Austria
 - Azerbaijan
 - Bulgaria
 - Brunei
 - Belarus
 - Brazil
 - Belgium
 - Cyprus
 - Czechia
 - Germany
 - Denmark
 - Estonia
 - Egypt
 - Finland
 - France
 - Georgia
 - Greece
 - Croatia
 - Hungary

- Ireland
- Italy
- Kyrgyzstan
- Kazakhstan
- Latvia
- Lithuania
- Luxembourg
- Malta
- Malaysia
- Mexico
- Moldova
- Myanmar
- Netherlands
- Peru
- Poland
- Portugal
- Romania
- Russia
- Sweden
- Slovakia
- Slovenia
- Turkmenistan
- Tajikistan
- Spain
- Ukraine
- Uzbekistan
- Vietnam
- "Other"

 **Note**

Due to the peculiarities of the **RoadAR** SDK, Cyrillic characters on the license plate are recognized by Latin characters.

The **RoadAR** software module can work in one of the following modes depending on the type of license:

1. Slow — the module processes 6 frames per second, evenly thinning the processed video stream in case of a higher camera frame rate. Recognizes the license plates of the vehicles moving at a speed of no more than 20 km/h.
2. Fast — the module processes 25 frames per second, evenly thinning the processed video stream in case of a higher camera frame rate. Recognizes the license plates of the vehicles moving at a speed of no more than 150 km/h.

5.2.11.2 RoadAR module licensing

RoadAR software module is licensed **by the number of channels** using the intellect.sec key file, i.e. the key file is purchased for a certain number of cameras used for the module with payment for each camera. Additional key files are not required.

There are two license types for **RoadAR** software module:

1. Slow;
2. Fast.

 **Note**

See [The RoadAR module functionality](#) for more details.

The **RoadAR** module is licensed by processed video channels, taking into account the type of license, i.e. the intellect.sec key file is purchased for a certain number of cameras used by this module in Slow or Fast mode, with payment for each camera.

Additional key files are not required.

5.2.11.3 Video camera mounting and setup requirements for the RoadAR software module

To ensure the recognition of the state license plates using the **RoadAR** software module, it is necessary to install and configure the video cameras in such a way that the following requirements are met:

Camera specifications	<ul style="list-style-type: none"> The recommended resolution of 720p or 1080p. The minimum frame rate of 5 fps, the recommended frame rate of 20 fps. Video stream: MJPEG, H.264 or no compression.
Video image	<ul style="list-style-type: none"> The video image should be clear, contrasting, without distortion, not blurry. Expected image contrast: the difference between the license plate characters and the background is not less than 20 units with the image brightness scale from 0 to 255. Minimum character height on the license plate is 10 px, recommended is 20 px or more.
Camera mounting	<ul style="list-style-type: none"> Installation height should be at least 3 above from the road. The maximum tilt of the video camera should not exceed 30° horizontally, and 45° vertically. Camera inclination should be minimum. Camera should be static.

5.2.11.4 Configuring the RoadAR software module

To configure the **RoadAR** software module, do the following:

- Depending on the license type, go to the settings panel of the **RoadAR module (fast)** or **RoadAR module (slow)** object, which is created on the basis of the **LPR channel** object.

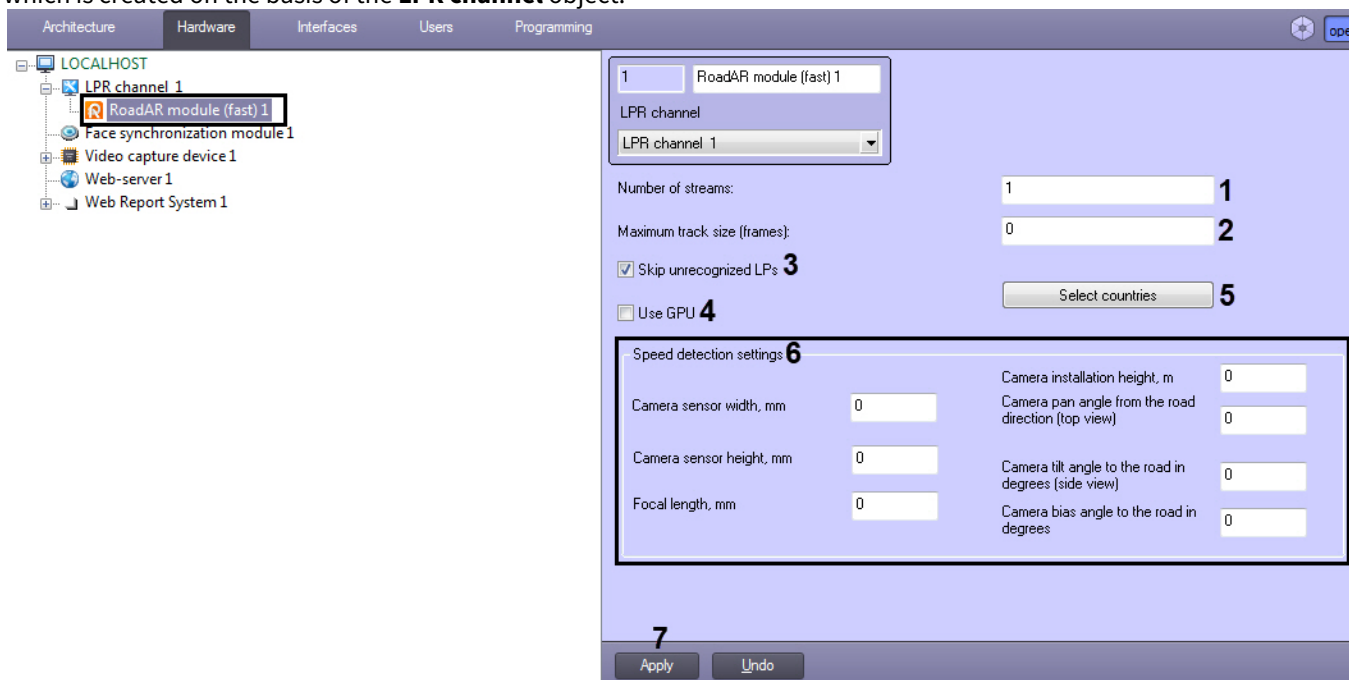

- In the **Number of streams** field (1), enter the number of streams that the **RoadAR** SDK will use in parallel computations. A value of 0 disables the calculating process paralleling for the license plate recognition.
- In the **Maximum track size (frames)** field (2), enter the maximum number of frames for one track that will be processed by the **RoadAR** SDK (the smaller the value, the faster the recognition result will be given, but it will also be less accurate). The default value is 0. The number of frames is not limited.

⚠ Attention!

If the LP recognition upon request is used (see [Setting up the Camera of recognition upon request module](#)), the **Maximum track size (frames)** should be equal to 1.

4. Set the **Skip unrecognized LPs** checkbox (3) to ignore the vehicles with unrecognized license plates.
5. Set the **Use GPU** checkbox (4) if it is necessary to use the NVIDIA GPU resources to increase the license plate recognition performance. By default, only the CPU resources are used.

⚠ Attention!

The startup (initialization) of the license plate recognition algorithm on NVIDIA GPU can take about one minute. No LP recognition events will be received until the initialization is complete.

6. By default, only numbers of the main country are recognized, which is specified in the settings panel of the **LPR channel** object (see [Selecting the country and license plate recognition SDK](#)). If it is also necessary to recognize the numbers of additional countries, click the **Select country** button (5) and in the **Country selection** window that opens, select the required countries.

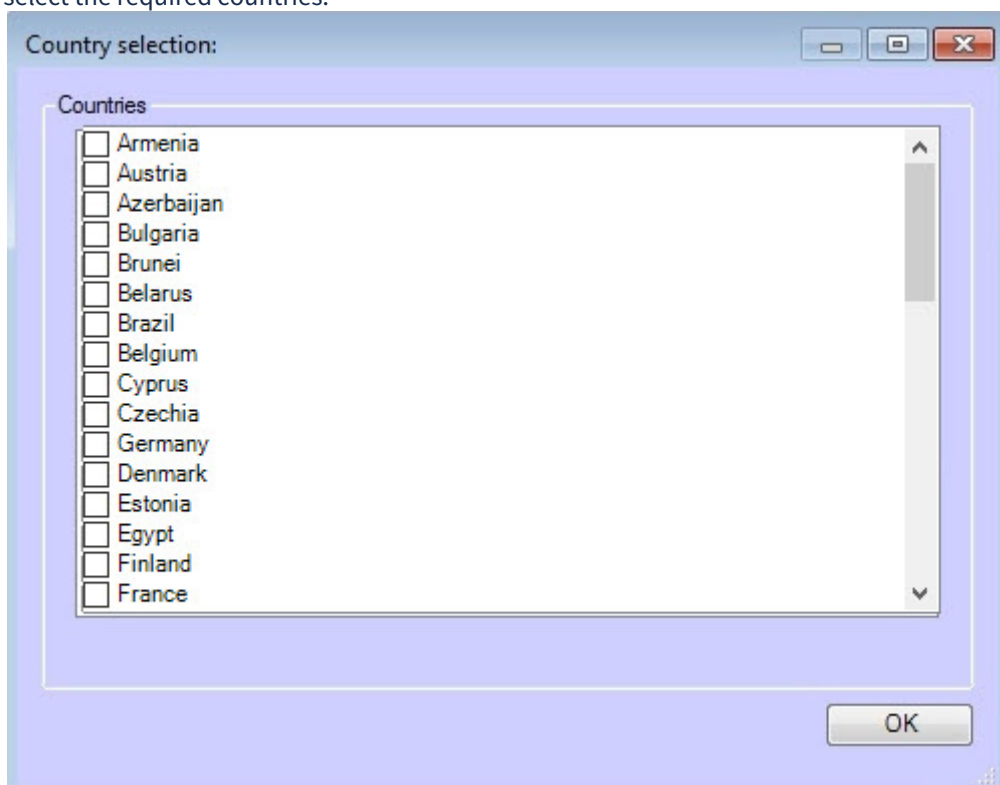

7. If it is necessary to determine the speed by video, specify the appropriate camera settings (6). The specified parameters should correspond to the actually used camera and its mounting parameters.
8. To save the settings, click the **Apply** button (7).

The configuration of the **RoadAR** software module is complete.

i Note

If several *Roadar* recognition channels are created, the load on the CPU cores may be uneven, because the even distribution mode isn't enabled by default. To enable it, set the **1** value for the string parameter of the **IsProcessObject** registry key (see [Vertical solutions](#)).

5.2.12 VIT

5.2.12.1 The VIT module functionality

The **VIT** software module supports the following functionality:

1. Recognizing the license plates.
2. Saving the recognized number to the plates detector database.

3. Determining and logging the speed of the recognized vehicle to the plates database (by video or using the **Speed traps server** module).
4. Check the recognized plates of vehicles via connected search database.
5. Possibility to work with multilane driveway (recognizing of vehicle plates in one frame is not more than 10).
6. Identification of extended list of license plates types: all types of Russian license plates, all CIS countries and Baltic States, countries of Europe, Latin America and The USA. Worked out the main types of single-line plates of different countries, for each both civil and specialized (diplomatic, transit, military etc.). The full list of countries is given on the manufacturer's [site](#).

Note.

Missing countries can be added into the recognition module if necessary. For that, contact the [AxxonSoft technical support](#) and provide a video recording with license plates of the required country. The final decision on adding a country to the module is made by the module manufacturer.

7. Possibility to change the quality level of vehicle plates recognizing.

Note

The LP number recognition accuracy depends on the quantity of symbols on the LP — more symbols means better accuracy.

8. Saving the frames of the recognized plates to bmp, jpeg and avi formats.

The **VIT** software module can work in one of the following modes depending on the type of license:

1. Slow — the module processes 6 frames per second. **VIT** SDK evenly decimates the processed video stream in case of a higher camera frame rate. It recognizes the license plates of the vehicles moving at a speed of no more than 20 km/h.
2. Fast — the module processes 25 frames per second. **VIT** SDK evenly decimates the processed video stream in case of a higher camera frame rate. It recognizes the license plates of the vehicles moving at a speed of no more than 150 km/h.

5.2.12.2 VIT module licensing

On the page:

- [General information on the VIT module licensing](#)
- [How to activate a Hasp hardware security key for the VIT module](#)
- [How to activate a software demo key for the VIT module](#)
- [How to activate a software license key for the VIT module](#)

5.2.12.2.1 General information on the VIT module licensing

The *VIT* module licensing in the *Auto Intellect* software is performed by processed video channels and countries/regions (a region is a set of countries).

To prevent the loss of processed frames, it is recommended that each megapixel of the video camera be processed in a separate stream. In this case, 1 stream uses 1 license channel.

Note

For example, if you use one video camera with a resolution of 1920×1080 (2 megapixels), it is recommended to purchase a license for 2 channels and process the frames using 2 streams (see [Configuring the VIT module](#)). For two video cameras with a resolution of 4 megapixels, it is recommended to purchase a license for 8 channels and process the frames of each camera using 4 streams.

There are two license types for VIT program module:

1. Slow;
2. Fast.

Note

See [The VIT module functionality](#) for more details.

Slow or Fast license types can be represented as follows:

1. *Hasp* hardware security key (purchased separately). The key can be remotely updated when it is required (to expand the permanent key or convert demo key to the permanent key).
2. Software license key. This key is binded to computer hardware.
3. Software demo key.

Note

One demo key may include several licenses.

There can be several keys with Slow and/or Fast license types on one Server. In this case, the number of channels of all keys is summed within the license type (Slow channels are summed separately from the Fast channels).

If there is a single key with several licenses on the Server, then in this case, the license with the biggest product of the channels number and the recognition frame rate is used. For example: the key includes 2 licenses, the first is a Slow license for 10 channels (10 channels * 6 fps), the second is a Fast license for 2 channels (2 channels * 25 fps). In this case the Slow license for 10 channels will be used, because 60 is more than 50.

Note

It is possible to use a network license.

5.2.12.2.2 How to activate a Hasp hardware security key for the VIT module

To ensure the operation of the *Hasp* hardware security key, it is necessary to download and install the [HASPUserSetup.exe](#) driver distribution kit.

5.2.12.2.3 How to activate a software demo key for the VIT module

It's possible to use the VIT program module in demo mode. License plates recognition of all available countries is permitted in demo mode on 4 Fast channels or 4 Slow channels. Demo mode is active for 60 days since the software key activation.

Attention!

VIT module demo mode usage on virtual machines is not allowed.

Activation of demo-mode is performed as follows:

1. Download installation package: [Fast](#); [Slow](#).
2. In the folder with the installation package, run the command line as the system administrator.
3. Execute **SDK_4hi_60d_WORLD.exe -i -fi -fss** command (for the Fast demo license) or **SDK_4lo_60d_WORLD.exe -i -fi -fss** (for the Slow demo license).

- To enable the archive search in the integration mode with *Axxon Next*, download and install the [archive_search.exe](#) distribution kit.

Note

In the case of errors refer to the VIT documentation.

Demo licensing is activated.

5.2.12.2.4 How to activate a software license key for the VIT module

In order to receive the software license key for the VIT module, proceed as follows:

- Download the utilities by the links below:
 - [haspdinst-8.31.exe](#)
 - [RUS_EOAWT.exe](#)
- In the folder with the installation package, run the command line as the system administrator and execute the following two commands one after another to install the protection key driver:

```
haspdinst-8.31.exe -fr -purge
haspdinst-8.31.exe -i -fi -fss
```

- Wait for the installation completion.



- Click **OK** in the dialog box to confirm installation is completed.

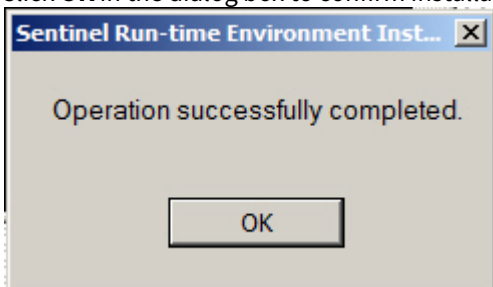

- Check installation correctness by opening the http://127.0.0.1:1947/_int_/ACC_help_index.html page in the web browser.



- Run the `RUS_EOAWT.exe` file to start the Remote Update System. The **RUS** dialog box opens.

Note.

The RUS abbreviation stands for Remote Update System.

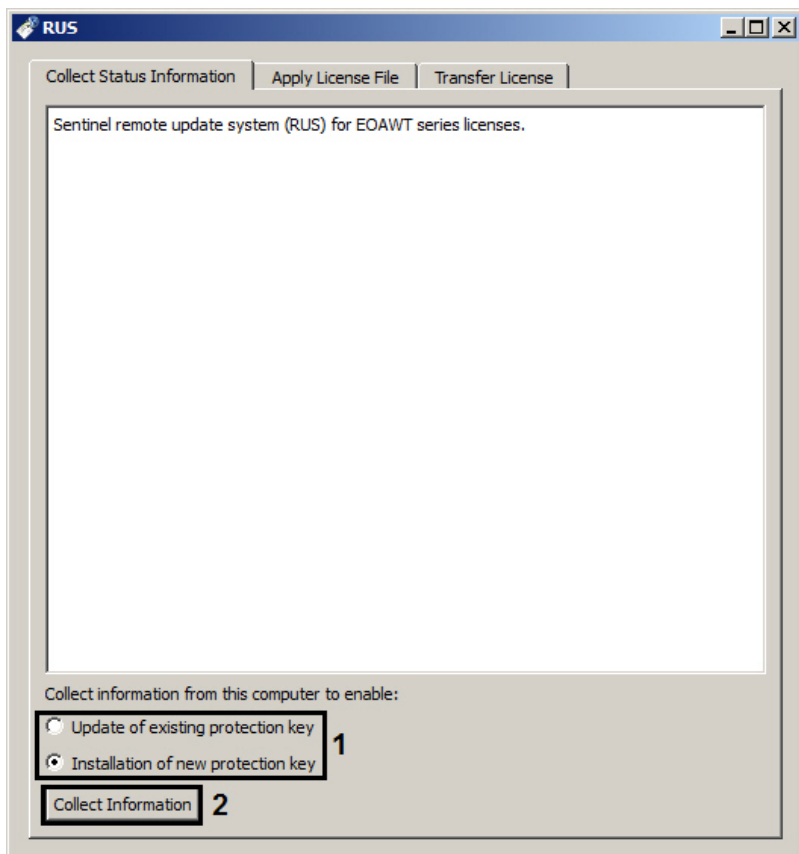

- Set the **Collect information from this computer to enable:** switch into the **Installation of new protection key** position in case if license for a "clean computer" is needed, i.e. if there is no demo license on it, or to the **Update of existing protection key** position, if demo license is already in use (1).
- Click **Collect Information** (2).
- Save the file with .c2v extension to any folder.
- Close the RUS_EOAWT.exe tool.
- Hand the .c2v file to your AxxonSoft manager.
- Receive the license file with .v2c extension from your AxxonSoft manager.

- Run the RUS_EOAWT.exe tool and go to the **Apply License File** tab (1).

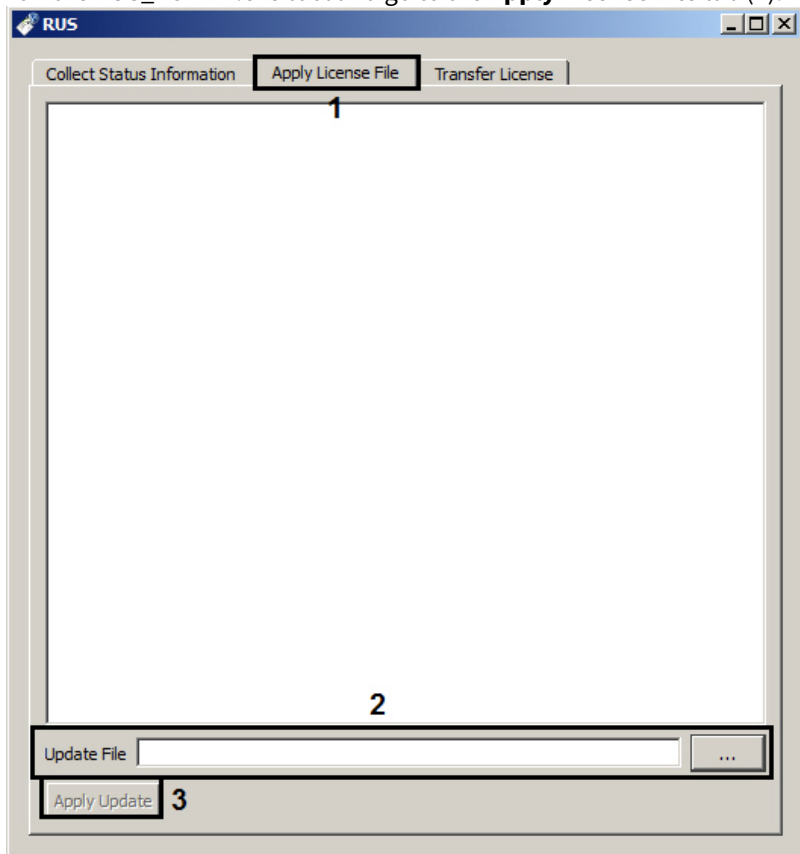

- Specify location of the license file in the **Update File** field using the ... button (2).
- Click **Apply Update** (3).

Receiving the software license key for the VIT module is now completed.

5.2.12.3 Video camera mounting and setup requirements for the VIT software module

o ensure the recognition of the state license plates using the **VIT** software module, it is necessary to install and configure the video cameras in such a way that the following requirements are met:

<p>Camera specifications</p>	<ul style="list-style-type: none"> • Basic characteristics of used video cameras are presented in the General requirements for mounting and configuring of cameras section.
<p>Video image</p>	<ul style="list-style-type: none"> • The symbols height for IP cameras should be not less than 20-30 px, for analog cameras - not less than 14-20 px, the stroke width should be not less than 2 px; • Minimum allowed contrast with evenly dirty number plate should not be less than 10% (contrast differentiation of symbols to the background is 25 on 256 point scale); • Maximum allowed uneven dirtiness is not more than 12% (ratio of the dirty area of the number plate to its whole area); • Geometrical proportions of the number plate picture should not differ from such proportions of the number plate itself with more than 10%.
<p>Camera positioning</p>	<ul style="list-style-type: none"> • The camera should be installed permanently (for detailed installation information, see the vendor documentation);
<p>Vehicle speed</p>	<ul style="list-style-type: none"> • In Slow mode - vehicle speed is no more than 20 km/h • In Fast mode - vehicle speed is not more than 150 km/h

Examples of LP images that will be recognized correctly and completely:



To ensure the correct recognition of the LP number, its image should not be:

- unequally lit;



- overexposed;

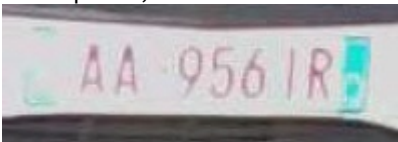

- blurred (due to incorrect shutter speed settings for the speed of the vehicle);



- distorted (due to incorrect placement of the camera);



- interlaced;



- dirty.



⚠ Attention!

Any deviation from the above requirements reduces the likelihood of correct number recognition.

5.2.12.4 Configuring the VIT module

Configure the **VIT** program module as follows:

1. Go to the **VIT module** object settings panel, which is created on the basis of the **LPR Channel** object.

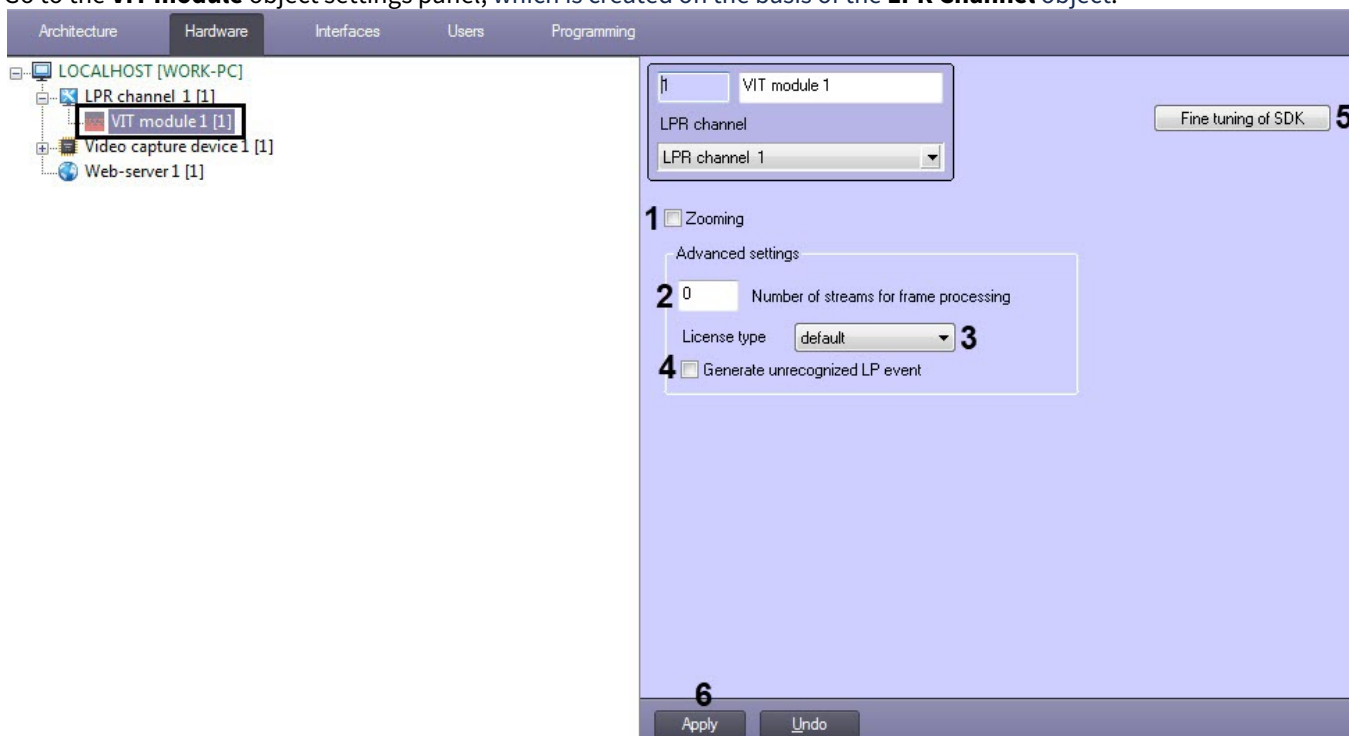

2. Set the **Zooming** checkbox checked to increase the plate recognizing speed on mega-pixel video cameras without loss of recognizing quality (1).

Note

This check box is relevant when the value of the **Zone width** parameter is more than 150 pixels (see [Setting up the LPR channel detector](#) section). The recognizing speed is increasing:

- 2 times if the value of the **Zone width** parameter is more than 150 pixels;
- 4 times if the value of the **Zone width** parameter is more than 400 pixels;
- 8 times if the value of the **Zone width** parameter is more than 800 pixels.

3. To prevent the loss of processed frames, it is recommended that each megapixel of the video camera be processed in a separate stream. If there is a loss of frames, then it is necessary to increase the number of streams in the **Number of streams for frame processing** field (2):
 - a. If the value of the **Number of streams for frame processing** field is **0**, recognition will be performed in the same stream it was started. It is the default value.
 - b. If the value of the **Number of streams for frame processing** field is **1**, recognition will be performed in the parallel stream to the process that starts it. This is the recommended value.
 - c. If the value of the **Number of streams for frame processing** field is **2** or more, recognition will be performed in two or more streams simultaneously to the process that starts it. However, in this case, 1 license channel is used for each stream.

Attention!

The specified number of streams should not exceed the number of CPU cores on the Server.

4. From the **License type** drop-down list (3) select the type of license used:
 - default - the license type is determined automatically;
 - fast (25 fps);
 - slow (6 fps).

Attention!

If you select the license type that is not in the key, then license plate recognition will not work.

5. Set the **Generate unrecognized LP event** checkbox (4), if it is necessary to generate **NOT DETECTED** event for vehicles whose LP wasn't be recognized.
6. Perform fine tuning of SDK if required (5) (see [VIT module object settings panel](#)).

⚠ Attention!

Fine tuning of SDK is to be performed only with the help of AxonSoft specialists!

i Note

The current SDK version can be found by the name of the VIT_<SDK version> folder, for example:

- for x32: <Auto Intellect installation directory>\Modules\UrmLpr\VIT_2.14.0.
- for x64: <Auto Intellect installation directory>\Modules64\UrmLpr\VIT_2.14.0.

Also, the current SDK version can be found using the **vpwfetch.exe -v** command in the Windows command line, while in the corresponding folder.

7. Click **Apply** button (6) to save the changes.

The **VIT** program module is now configured.

i Note

It is possible to track the disappearance of the recognized number. If the recognized number disappeared from the camera field of view and was not recognized again within the specified time, the lost number event will be generated. To enable this feature, in the **VIT.TimeoutLostNumber** parameter, set the time in milliseconds after which the lost number event will be generated (for details, see [Registry keys reference guide](#), for more information about working with the registry, see [Working with Windows OS registry](#)).

To ensure the operation of this feature, it is necessary to set the **True** value for the **VodiCTL_VPW_DYNAMIC_ENABLE** tweaking parameter (see [The VIT module object settings panel](#)).

⚠ Attention!

To ensure the proper operation of the **VIT** program module, it is necessary to grant the read/write access for the current Windows user to the following catalogues and files:

- <Auto Intellect installation directory>\Modules\UrmLpr\
- <Auto Intellect installation directory>\Modules64\UrmLpr\
- C:\ProgramData\VIT\LprPresetDemo\presets.xml

5.2.13 Taiwan

5.2.13.1 The Taiwan module functionality

The **Taiwan** software module supports the following functionality:

1. Recognition of Taiwanese vehicle license plates only.
2. Saving the recognized number to the plates detector database.
3. Identification and logging the determined speed of the vehicle to the license plates database (by video or using the **Speed traps server** module).
4. Check of recognized license plates via connected search database.
5. Possibility to work with multiline driveway (recognition of up to 10 vehicle license plates in one frame).
6. Saving the frames of the recognized license plates for debugging in bmp, jpeg and avi formats.

5.2.13.2 Taiwan module licensing

The **Taiwan** software module is licensed in *Auto Intellect* using a USB dongle.

If the USB dongle is not installed on the Server, then the **Taiwan** module will work in demo mode. In demo mode, the last character of the recognized LP number is replaced with an X character.

5.2.13.3 Video camera mounting and setup requirements for the Taiwan software module

For correct license plate recognition using the **Taiwan** module, it is enough to meet the general requirements for installing and configuring video cameras (see [General requirements for mounting and configuring of cameras](#)).

5.2.14 ARENA

5.2.14.1 The ARENA module functionality

The **ARENA** software module supports the following functionality:

1. License plates identification;
2. Saving the identified number to the plates detector database;
3. Identification and logging the determined speed of the vehicle to the plates database;
4. Identification and logging the determined class of a moving vehicle to the plates database.

5.2.14.2 ARENA module licensing

The integration with the **ARENA** module is channel-based. Thus, each connection to the **ARENA** module is paid separately.

5.2.14.3 Setting up the ARENA module

Note

In case when **ARENA** program module is used, the parent object **LPR channel** should not be set up.

The **ARENA** program module provides interaction of velocimeter and Arena photo fixation (Arena integrated circuit) and *Auto-Intellect* PC.

Arena integrated circuit is a monobloc unit containing inside the following devices:

1. radar;
2. camera;
3. computer with installed and set up ftp-server;
4. data storage;
5. devices, providing Arena integrated circuit workability

Note.

Detailed information about Arena integrated circuit is given in official reference manual.

Auto-Intellect server requires photos with a stated period of time from Arena integrated circuit. In case when the *Auto-Intellect* server and Arena integrated circuit are disconnected and then the connection is restored, the photos made during the connection loss will be downloaded from the ftp-server.

Note.

In case of Arena's Web-interface incorrect close the *Auto-intellect* complex stops receiving events.

To set up the **ARENA** program module, the following data about the Arena integrated circuit are necessary:

1. IP-address of the Arena computer with installed and set up ftp-server;
2. Port for connection to the ftp-server;
3. User name and password for connecting to the ftp-server.

Setting up **ARENA** program module is performed in the following way:

1. Go to the **ARENA module** object settings panel, which is created on the basis of the **LPR Channel** object (2).

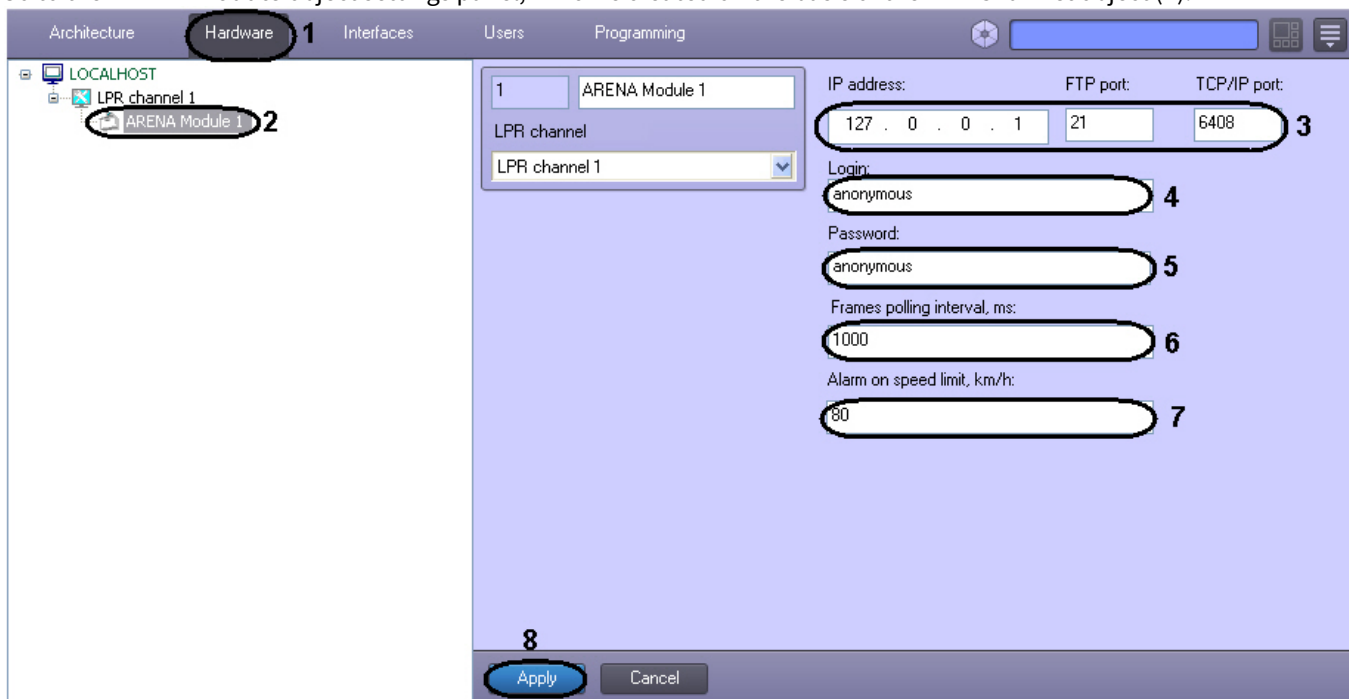

2. In the **IP address** field enter the IP-address of the Arena computer with installed ftp-server (3).
3. In the **FTP Port** field enter the port for connection to the ftp-server (3). Port 21 is used by default.
4. In the **TCP/IP Port** field enter the TCP/IP port for connection to the ftp-server (3). Port 6008 is used by default.
5. In the **Login** (4) and **Password** (5) fields enter the user name and password for connection to this ftp-server.
6. In the **Frames polling interval, ms** field enter the time between two one by one requires of *Auto-Intellect* PC for downloading the photos from the Arena integrated circuit (6).
7. In the **Alarm on speed limit, km/h** field enter the maximum available vehicle speed in km/h (7). In case, when the vehicle moves at a speed above the maximum available vehicle speed, the system generates the report about the excessive speed.
8. Click **Apply** (8).

Setting up the **ARENA** module is completed.

5.2.15 ARH-Railway

5.2.15.1 The ARH-Railway module functionality

The *ARH-Railway* software module supports the following functionality:

1. Recognition of transport containers' license plates.
2. Recognition of carriages' license plates.
3. Writing the recognized license plate to the license plates recognizer database.

5.2.15.2 The ARH-Railway module licensing

The *ARH-Railway* software module uses the Carmen FreeFlow license type and is licensed by the used processor cores. There is an additional hardware key in the form of a USB key in case of licenses for one and two cores, and in the form of a PCI card in case of one, two and four cores. The number of recognition channels is limited by the processor capacity. There are no restrictions on the number of recognitions per time unit.

For the Carmen FreeFlow license type, it is possible to use multiple hardware keys of any type on the same computer. It is also possible to use hardware keys of different types (a USB key and a PCI key).

5.2.15.3 Configuring the ARH-Railway module

Attention!

To ensure the correct operation of the *ARH-Railway* module, do the following:

1. Make sure that the "KB3033929" security update and [Hotfix](#) are installed.
2. If *Carmen GX* drivers are installed, then they should be uninstalled from Windows.
3. Make sure that there is not a single folder with any drivers left at C:\Windows\System32\DRVSTORE\ (if there are folders, they should be deleted).
4. Restart the computer.
5. Download the *Carmen Freeflow 7.3.1* distribution package from the [AxxonSoft](#) website and install it. If an older version was installed earlier, then it should be uninstalled before installing a newer version.
6. Download the *Carmen ACCR-7.3.2* distribution package from the [AxxonSoft](#) website. This distribution package contains a recognizer that should be installed via the *Engine Manager* utility. The procedure for installing the SDK using the *Engine Manager* utility is described in the `engine_install_windows.txt` file located in the folder with the corresponding recognizer.
7. Download the *ARH Railroad Wagon Code Recognition Engine* distribution package from the [AxxonSoft](#) website and install it via the *Engine Manager* utility. The procedure for installing the recognizer using the *Engine Manager* utility is described in the `engine_install_windows.txt` file located in the folder with the corresponding recognizer.
8. Install the software from the [manufacturer's website](#).

The *ARH-Railway* software module can be configured on the settings panel of the **ARH-Railway module** object created on the basis of the **LPR channel** object.

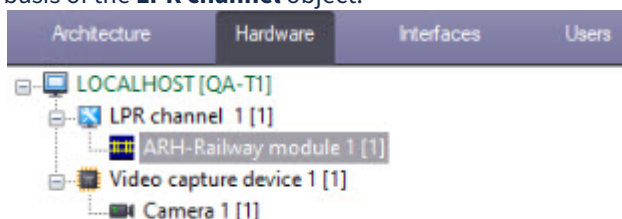

To configure the *ARH-Railway* module, do the following:

1. Go to the **Main settings** tab (1) of the **ARH-Railway module** object settings panel.

1 ARH-Railway module 1

LPR channel

LPR channel 1

Use	Name	Type
	cmocr-2.65-iso..	Containers
*	cmocr-2.103-iso..	OCR
	cmocr-2.77-iso...	OCR
	cmocr-2.87-aar..	OCR
	cmocr-2.89-uic...	OCR

General settings

SDK work sequence

Sequential 2

Quality: 30 3

Recognition frame rate: fps 4

1 Main settings cmocr-2.103-iso.dat

Apply Undo

2. From the **SDK work sequence** drop-down list (2), select **Sequential** or **Parallel**.
3. In the **Quality** field (3), enter the image quality of the carriage or container numbers, starting from which the numbers will be recognized. The value is determined experimentally.
4. In the **Recognition frame rate, fps** field (4), enter the number of frames per second processed by the recognizer. If you enter **0** or leave the field blank, the recognizer will process the maximum possible number of frames.
5. Go to the tab of the selected SDK.

Note

Selected SDKs are marked with an asterisk in the **SDK selection** table on the **Main settings** tab.

1 ARH-Railway module 1

LPR channel

LPR channel 1

Symbol height

Average: 32 **1**

Minimum: 28 **2**

Maximum: 40 **3**

Symbol inclination

Average (%): -2 **4**

Minimum (%): -30 **5**

Maximum (%): 21 **6**

Advanced settings

Slope (%): 1 **7**

Min. contrast: 15 **8**

X in Y (%): 100 **9**

Delay: 1000 **10**

Filters

ISO filter **11**

Long code filter **12**

Checksum test **13**

Main settings: cmocr-2.77-iso.dat

Apply Undo

6. In the **Symbol height** group, specify the parameters of the symbol height of the carriage or container license plates:
 - a. In the **Minimum** field (**2**), enter the minimum height of the symbol in pixels.
 - b. In the **Average** field (**1**), enter the average height of the symbol in pixels.
 - c. In the **Maximum** field (**3**), enter the maximum height of the symbol in pixels.
7. In the **Symbol inclination** group, specify the inclination parameters of the carriage number symbols on the video image from the camera:
 - a. In the **Average (%)** field (**4**), enter the average inclination of the symbol in percent. The value is positive if the horizontal axis of the symbols is tilted down when viewed from left to right, and negative if this axis is tilted up.
 - b. In the **Minimum (%)** field (**5**), enter the minimum inclination of the symbol in percent. The value is positive if the horizontal axis of the symbols is tilted down when viewed from left to right, and negative if this axis is tilted up.
 - c. In the **Maximum (%)** field (**6**), enter the maximum inclination of the symbol in percent. The value is positive if the horizontal axis of the symbols is tilted down when viewed from left to right, and negative if this axis is tilted up.
8. In the **Advanced settings** group, specify:
 - a. In the **Slope (%)** field (**7**), enter the slope of the carriage LP number in relation to the video image received from the camera in percent. The value is positive if the horizontal axis of the LP symbols is tilted down when viewed from left to right, and negative if this axis is tilted up.
 - b. In the **Min. contrast** field (**8**), enter the estimated difference between the shades of gray of the LP symbols and the background.
 - c. In the **X in Y (%)** field (**9**), enter the rate of the horizontal symbol resolution to the vertical one in percent. The horizontal resolution is the ratio of the symbol width on the video image to its actual width, and the vertical resolution is the ratio of the symbol height on the video image to its real height. If you enter zero or negative value, then the value will automatically change to 100.
 - d. In the **Delay** field (**10**), enter the time interval in milliseconds that should expire in order for the recognition module to display the next number recognition result. A zero value means no delay.

Note

- Increasing the delay time can be useful if the same carriage number is displayed too often.

- If you use the LP recognition upon request (see [Setting up the Camera of recognition upon request module](#)), there should be no delay.

9. In the **Filters** group, specify:
 - a. Set the **ISO filter** checkbox (**11**) if it is necessary to enable the ISO carriage numbers filtering. When reading a number that consists of 11 symbols, the recognition module will attempt to read the ISO code (examples of ISO codes: GB4310, 22G1).
 - b. Set the **Long code filter** checkbox (**12**) if it is necessary to enable the long numbers filtering. If the video image does not contain the carriage number, but contains some other text, the recognition module can display a false carriage number. The long numbers filtering reduces the likelihood of the false numbers appearing, increases the runtime (by about 5%), and degrades the recognition of the carriage codes on the images with a carriage code (by about 0.5%).
 - c. Set the **Checksum test** checkbox (**13**) if it is necessary to test the checksum.
10. Click the **Apply** button to save the settings.

Configuring the *ARH-Railway* software module is complete.

5.2.15.4 Requirements for mounting and configuring cameras for carriage recognition

The image received from video cameras must be sharp, contrast and readable for the correct recognition of containers license plates.

Requirements for the video camera characteristics:

1. It is recommended to use the resolution of no more than 800x600, because using a resolution of more than 800x600 does not lead to the recognition quality improvement.
2. High resolution black and white cameras are recommended because they provide better quality of image at low light conditions.
3. Recommended frame rate is 25 FPS.
4. The carriage speed must meet the camera operation speed. For a better recognition, it is necessary, and it is enough to have 1-2 frames of a carriage number.
5. It should be possible to set a fixed exposure value (shutter) on a video camera of 1/2000 s or less.
6. The video cameras should have high sensitivity (0.01 lx or more).

Requirements for video camera position:

1. The distance between the video camera and the carriage should be at least 1.5 meters (depends on the focal length of the camera lens), the optimal distance is 5-7 meters.

Note

To simplify the setting, it is recommended to use the varifocal lenses. The focal length variation range should be selected in each case of the system installation.

If you use the camera with an integrated lens with a focal length of 2.8 mm or less, then there may be strong geometric distortions on the image. As a result, the recognition quality may go down. To avoid this, it is necessary to use special removable lenses with an aspherical lens, which eliminate these distortions.

2. The camera height for reading the side number is 3–3.5 meters. The camera height for reading the chassis number is 1.5 meters.
3. The width of the carriage plate number in the image should be about 30-35% of the total image width, in most cases this means the width of the camera control zone is 3-5 meters.
4. The optical axis of video camera should be perpendicular to the plane of carriage plate number.
5. The position of the carriage in the frame should be strictly horizontal.
6. The infrared sensor and the video camera should be located in the same vertical plane.

Note

If the analog video camera is used, then to prevent the video signal fading on the transmission line, it is necessary that the distance from the video camera to the digitizing device does not exceed 30 meters.

Image requirements:

1. The minimum character height in the frame should be 16 pixels, 20–50 pixels are recommended. The width of the character line should be at least 2-3 pixels.

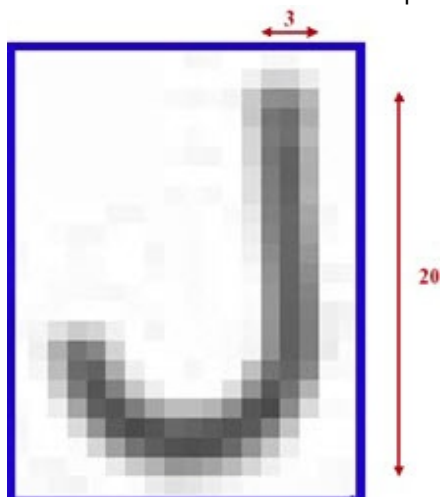

2. The geometric distortion by optics ("barrels" and "pincushions") should be reduced.
3. The image of the carriage plate numbers should be clear, contrast and readable.

When configuring video cameras, it is also required:

1. Focus camera exactly on the carriage plate number.
2. Disable the AGC mode in video camera.
3. Disable the modes of adding contrast in video camera.

To provide the system operation at night, use the searchlight lighting of carriages/cisterns. Use usual halogen spotlight with a capacity of 1–1.5 kW when mounting spotlight in the distance of 5-7 meters from railway. Locate spotlight as shown in the figure below. Such location allows avoiding the following:

1. Blinding of camera by spotlight directed to it from another side of railway.
2. Image flashing by light reflection from carriage.

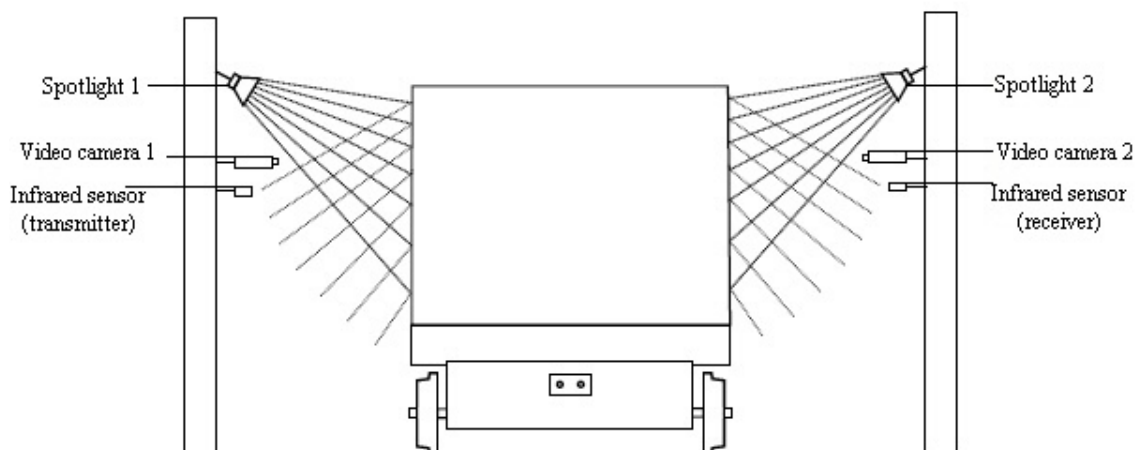

The reference image received from the correctly mounted and configured video camera is shown in the following figure.



5.2.15.5 Requirements for mounting and configuring cameras for container recognition

The image received from video cameras must be sharp, contrast and readable for the correct recognition of carriages and containers license plates.

Requirements for the video camera characteristics:

1. Use video cameras with high resolution (720p is recommended).
2. Frame rate is not less than 24 FPS.
3. The container speed must meet the camera operation speed. For a better recognition, it is necessary, and it is enough to have 1-2 frames of a container number.
4. It should be possible to set a fixed exposure value (shutter) on a video camera of 1/2000 s or less.
5. High sensitivity of video cameras (0.01 lx and more).

The optical axis of a video camera must be perpendicular to the plane of the license plate. To simplify the setting, it is recommended to use the varifocal lenses. The focal length variation range should be selected in each case of the system installation.

Image requirements:

1. The position of a carriage or a container in the frame should be strictly horizontal.
2. Size of the license plate characters in the image must be from 20 to 40 pixels, i.e. from 4% of the image height.
3. The geometric distortion by optics ("barrels" and "pincushions") should be reduced.

When configuring video cameras, it is also required:

1. Focus camera exactly on the container or carriage license plate and disable the auto focus.
2. It is recommended to disable all video camera smart features. For example, the contrast enhancement mode.

The diagrams of mounting video camera for providing the exact recognition of container license plates are shown in the following figures.

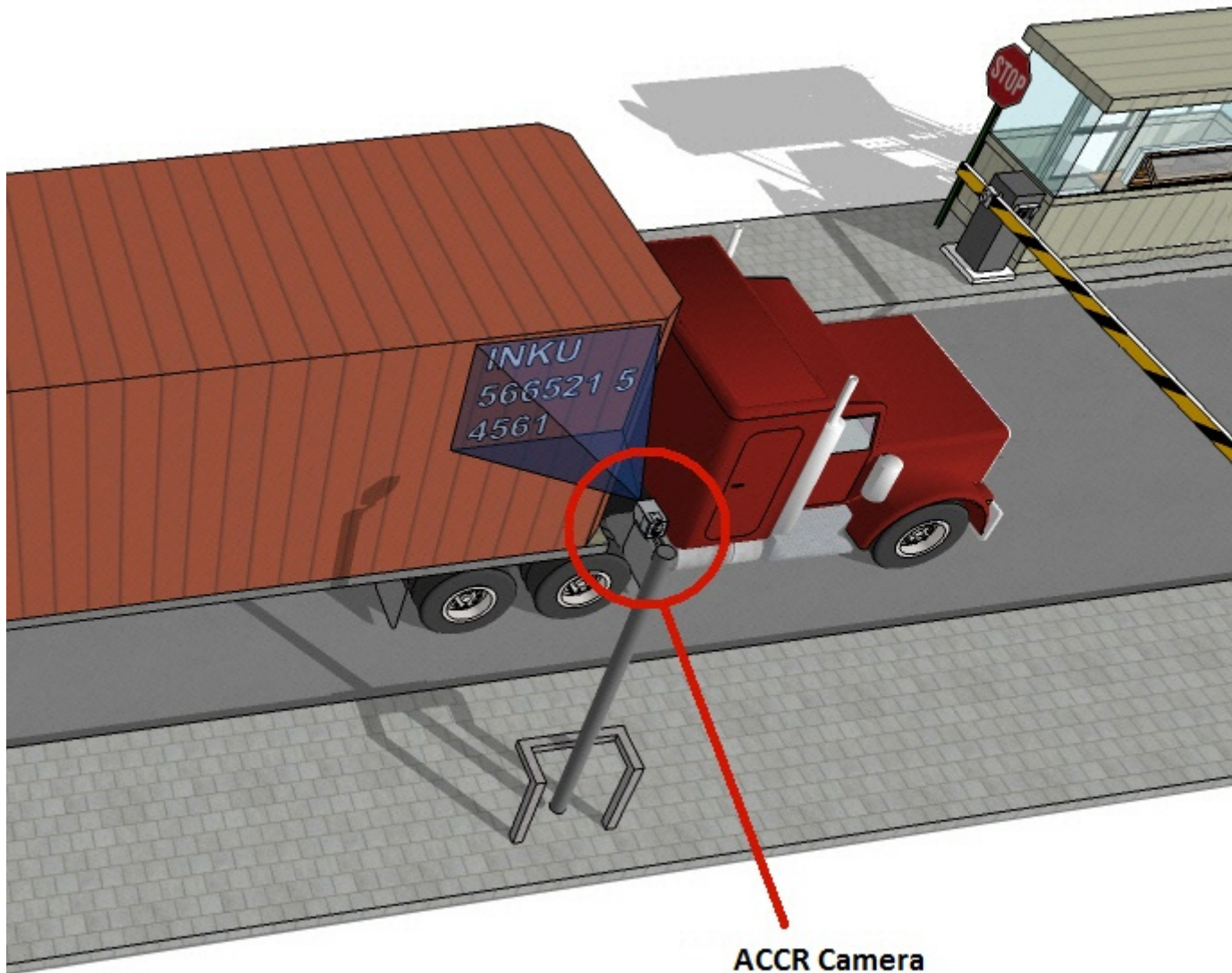

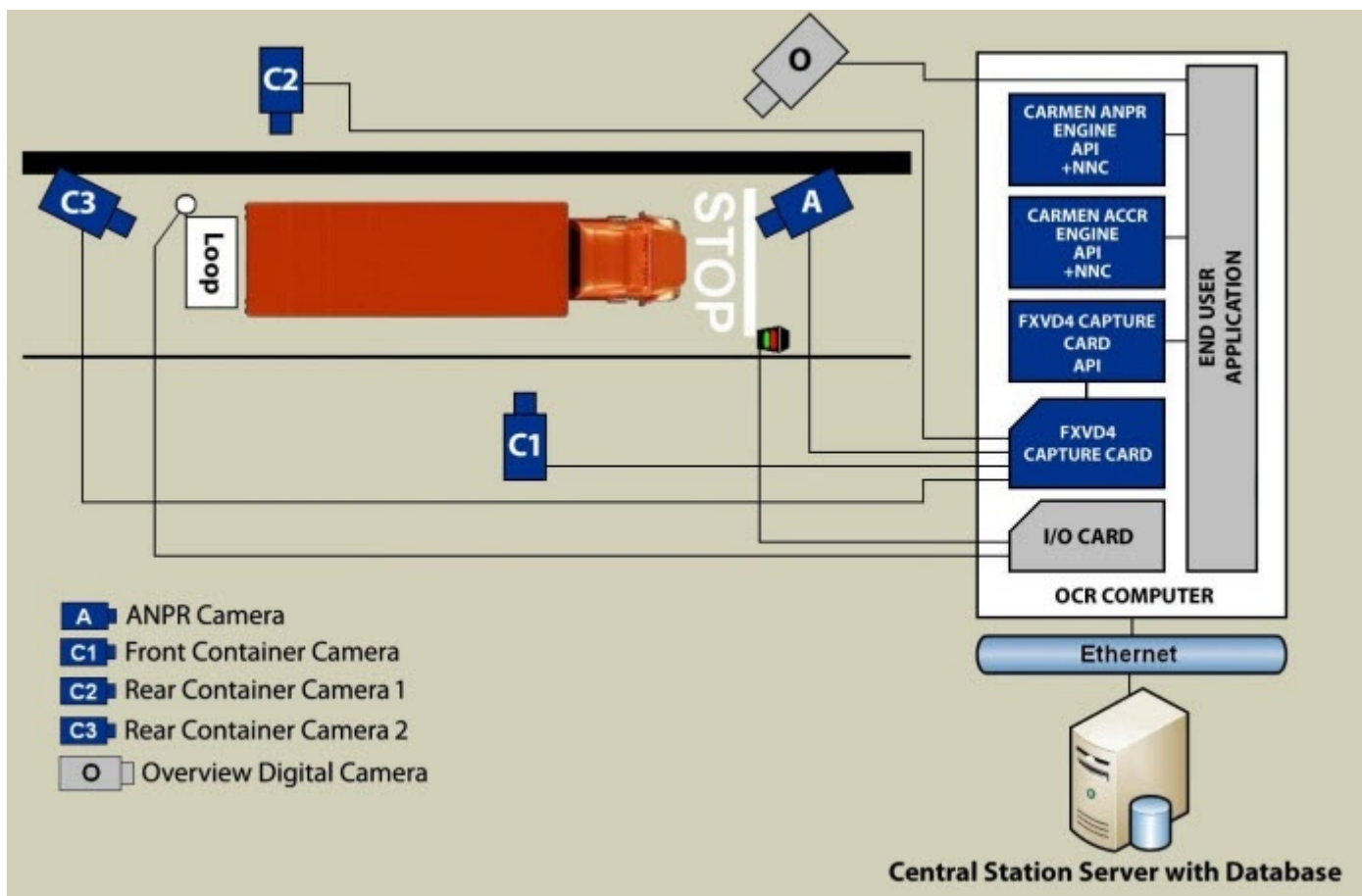

⚠ Attention!
 The FXVD4 capture card and API are required only when you use analog CCTV cameras.

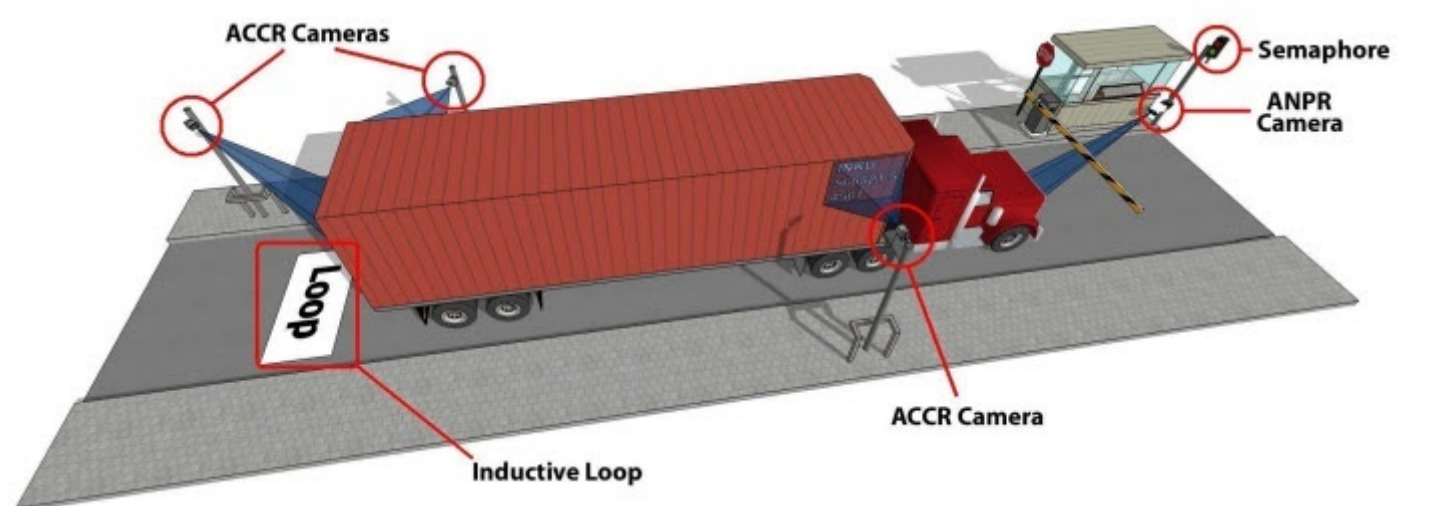

In the above image, you can see a sample application for the ACCR purposes. In many cases the container codes are damaged, therefore we suggest capturing multiple images from different sides of the container and process them together as an image sequence. To get the most precise reading results, it is recommended to use three container cameras. To provide the optimal conditions for taking an image, use two external white LED illuminator devices. With the help of an additional ANPR camera, a truck, carrying a container, can be identified.

To reduce consumption of the computer resources, use external triggering to capture images only if the container code and the license plate are in a good position.

The inductive loop (other triggering possibilities: laser sensor, microwave sensor, magnetic sensor or infrared barrier) serves as a sensor, which indicates the arrival of the vehicle.

As the vehicle stops at the “STOP” sign, all cameras identify the container code and the license plate of the truck.

The reference image received from the correctly mounted and configured video camera is shown in the following figure.

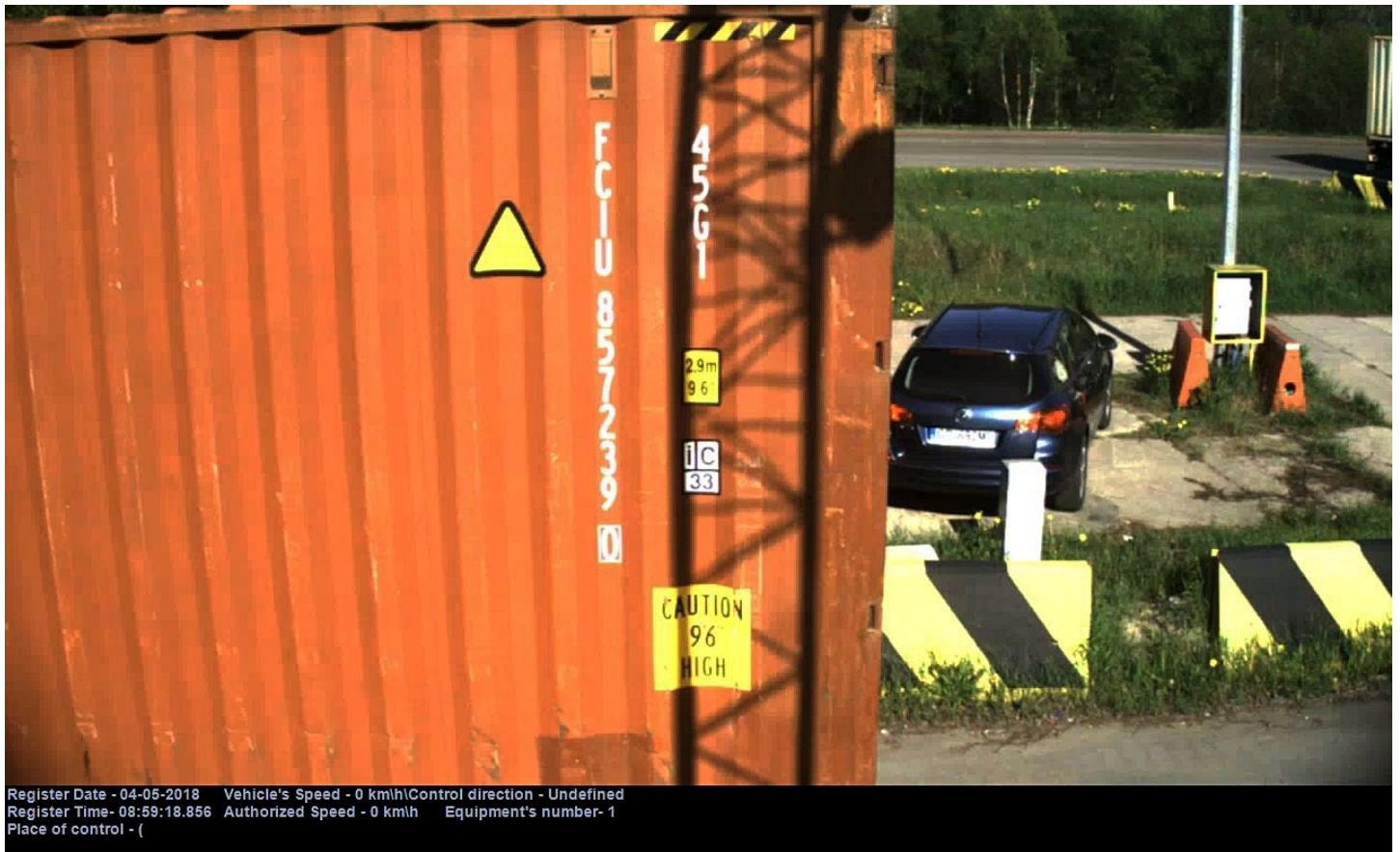

5.2.15.6 Combining the carriages and containers SDK

Trains with carriages and containers go on the railway track, their license plates include different types of codes. For their recognition, there are three versions of SDK (software development kit) that are a toolkit for the software development in one installable package:

1. iso.

Example of a license plate that can be recognized with the iso SDK:



- 2. accr.
Example of a license plate that can be recognized with the accr SDK:



- 3. aar.
Example of a license plate that can be recognized with the aar SDK:



5.2.15.6.1 Example of a carriage license plate recognition with the aar SDK

ONLINE MONITOR
Server status



TBOX638443



Parameter	Value
Recognizer	LPR channel 2
Recognition time	2021-10-27 10:43:38
Validity	82 %
Direction	Undefined
Regional code	443
Camera	Camera 2
SDK data file	cmocr-2.87-aar.dat

Cars

Processed Hide

Show All

Trace

Alarm

Accept

TBOX638443

LPR channel 2
2021-10-27 10:43:38

TBOX66613

LPR channel 2
2021-10-27 10:43:27

TBOX889296

LPR channel 2
2021-10-27 10:43:22

DEAX20376

LPR channel 2
2021-10-27 10:43:10

FXE930414

LPR channel 2

5.2.16 External Plates DB

5.2.16.1 The External Plates DB module functionality

The **External Plates DB** software module supports the following functionality:

1. Automatic search (comparison) of recognized vehicle license plates in the plug-in license plate database (external Plates DBs).
2. Generation of an alarm event about the presence of a number in the corresponding external Plates DB.
3. External Plates DB replication in a distributed configuration with several Servers.

⚠ Attention!

Correct operation of the LP number database is possible only when the number of recognitions is not more than 480,000 per 24 hours.

ℹ Note

An example of an external database of license plates numbers is a wanted database.

Search results of recognized numbers in the external database are displayed in the **Vehicle Tracer** interface window (see [The Vehicle Tracer interface module](#)).

Auto Intellect supports the external databases in the following formats:

1. SQL Server 2014;
2. Access;
3. FoxPro;
4. Oracle.

Note

If an external LP number database in SQL Server 2008 format was previously in use, then it is necessary to migrate it to SQL Server 2014. To do this, create a backup of the lprex DB in SQL Server 2008, and then deploy it to SQL Server 2014.

5.2.16.2 Connecting and setting up of the external LP number database

5.2.16.2.1 External database connection and setup procedure

To setup the **External Plates DB** object do the following steps:

1. connect the external plates database;
2. set the names to the table's columns , that contain vehicle numbers, for displaying in the interface **Vehicle Tracer**;
3. select search numbers method in the external database;
4. set the number of displayed numbers, found in the external database in case when the search was made for a number component or license-plate number;
5. set the SQL- query in case, when the plate search is performed by SQL-query.

5.2.16.2.2 Connecting the external database

To connect the external database, do the following:

1. Go to the **External Plates DB** object settings panel.

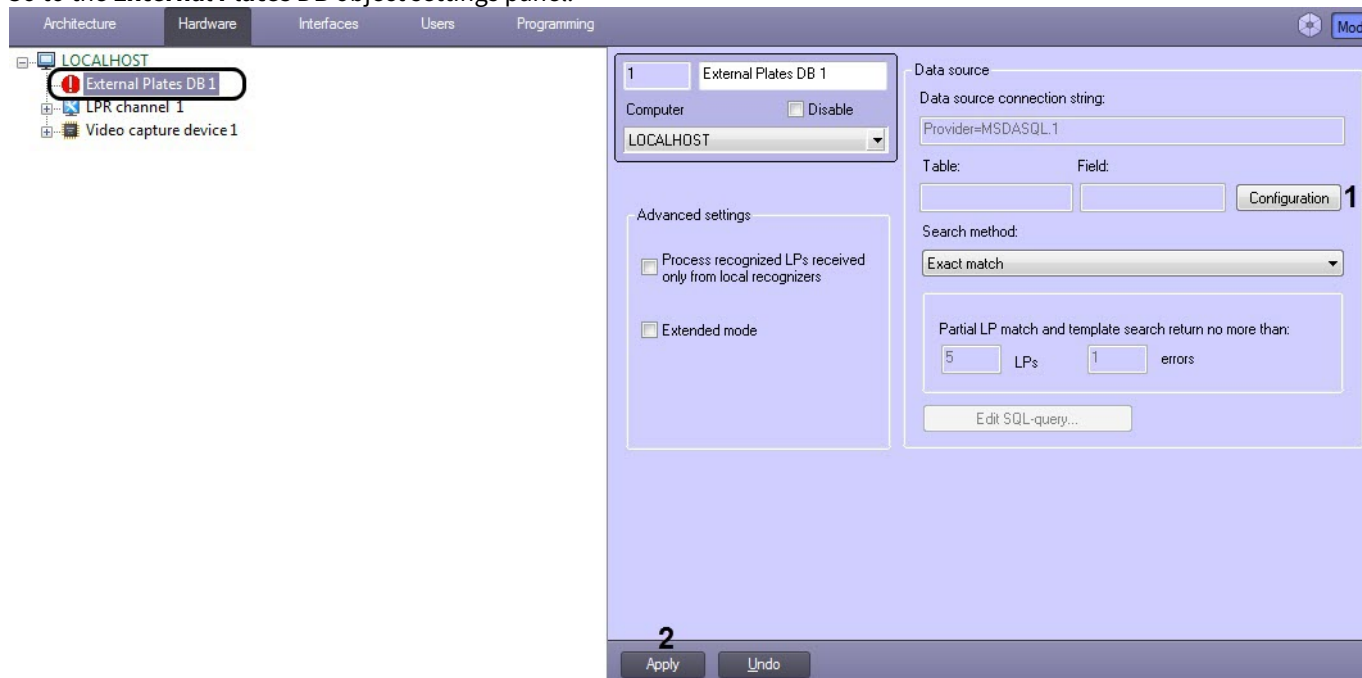

2. Click the **Configuration** button (1).
3. In the **External DB connection wizard** window that opens, click the **Configure...** button (1). If the *Auto-Intellect* database should be used as the external database, click **Local DB** (2) and go on to step 4.

Note

To connect to the Active tracking database, select the Local DB.

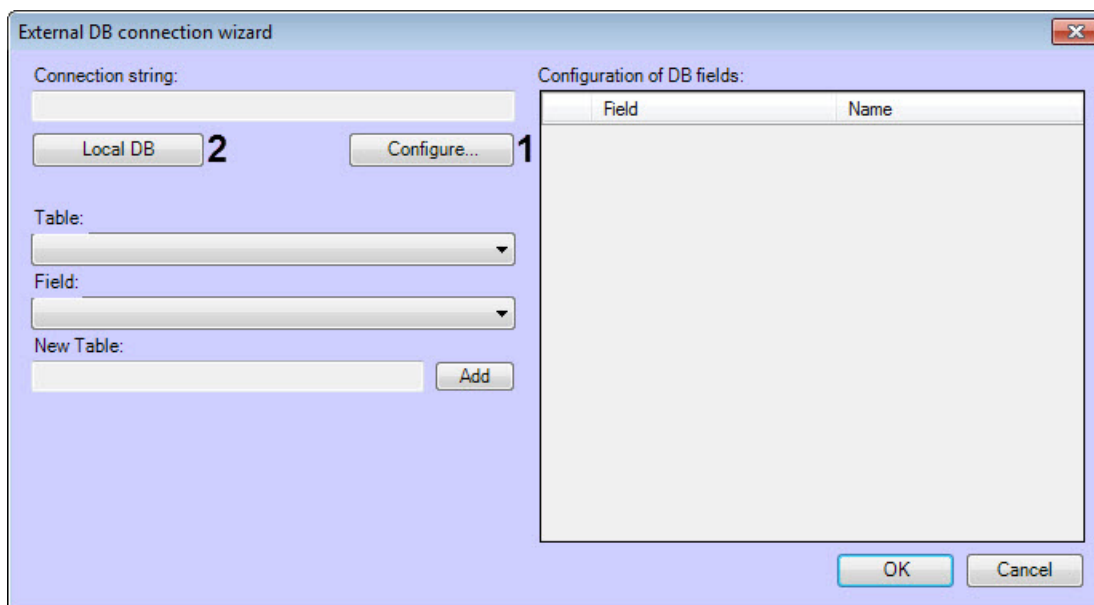

Note

If the external database is the *Auto-Intellect* database then you can add the LP numbers using the **Event search in the Recognizers DBs** dialogue window (see [Creating the Active tracking database](#)).

- a. As a result, the standard dialog window of database selection **Data Link Properties** will be displayed. Database selection process in the window **Data Link Properties** depends on the format of the connected database:
- SQL Server and Access. Detailed description of database selection in the stated formats is given in the [Database connection](#) section;

Note

The **Active tracking** database is maintained in SQL Server format. When you connect to it, select the Lprex database in the **Data Link Properties** window.

- FoxPro. Microsoft OLE DB for Visual FoxPro or other OLE DB provider should be used to connect to external database of the stated format;
- Oracle. Connection to the external database of the stated format is done in the following way:

Attention!

To connect an Oracle database, the following conditions must be met:

- the Oracle client is installed on the computer with the *Auto-Intellect* Server;
- the Oracle client is connected to the Oracle database server (the Listener component is configured).

Note

Detailed information about Oracle databases is given in the official reference manuals concerning this software.

- b. On the **Provider** tab of **Data Link Properties** dialog window select the **Microsoft OLE DB Provider for Oracle** value or **Oracle Provider for OLE DB**.

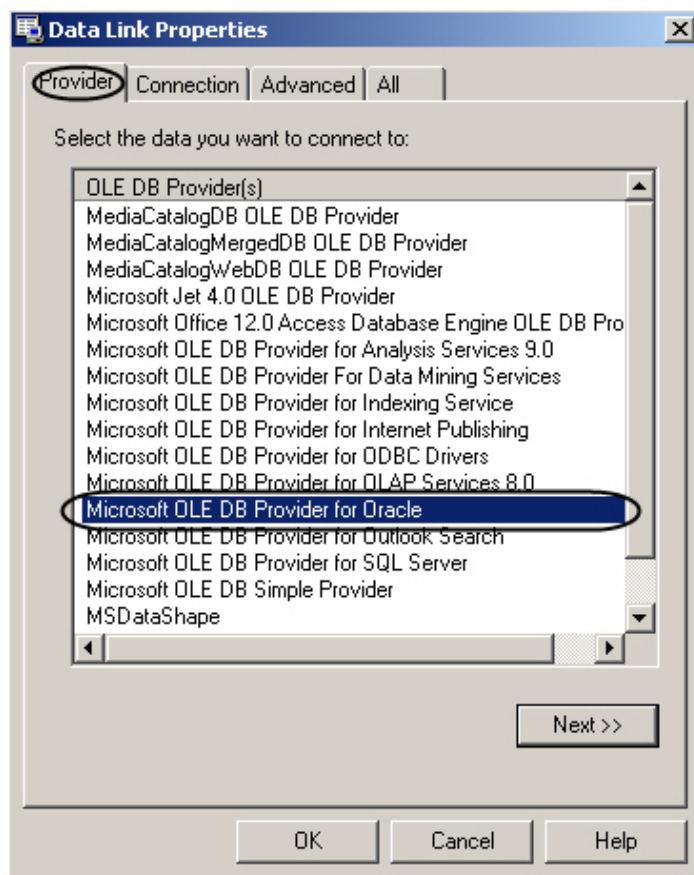

- Go to the **Connection** tab or click the **Next>>** button.
- In the **Use data source name** field (1), enter the server name of Oracle database to which the local client Oracle is connected.

Note

Oracle database name is specified upon its installation.

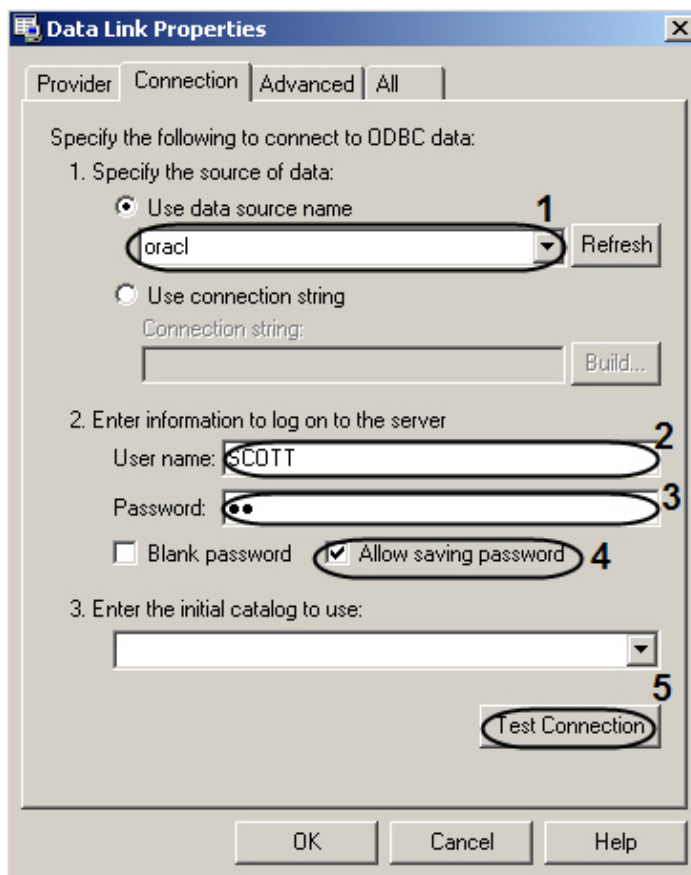

- In the **User name** (2) and **Password** (3) fields, enter the user name and password to connect to the Oracle database server.
- Set the **Allow saving password** checkbox (4).

Note

To check the connection to the Oracle database server, click the **Test Connection** button (5). If test connection succeeded, the message window would be displayed. To close the message window, click **OK**.

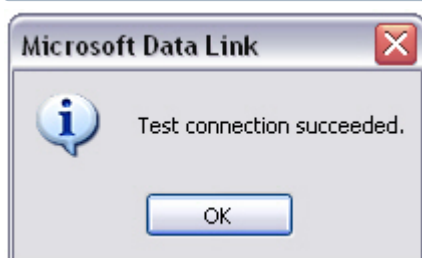

- To complete the connection to external Oracle database, click **OK**.

4. After the database is selected, the connection string with the selected database will be displayed in the **External DB connection wizard** window (1).

Note

The `idb.exe` utility is used to configure *Auto-Intellect* databases. Its operation is described in the [The `idb.exe` utility for converting databases, selecting database templates and making backup copies of databases](#) section. When you switch between databases, we recommend you to refer to the [Using the `idb.exe` utility](#) section.

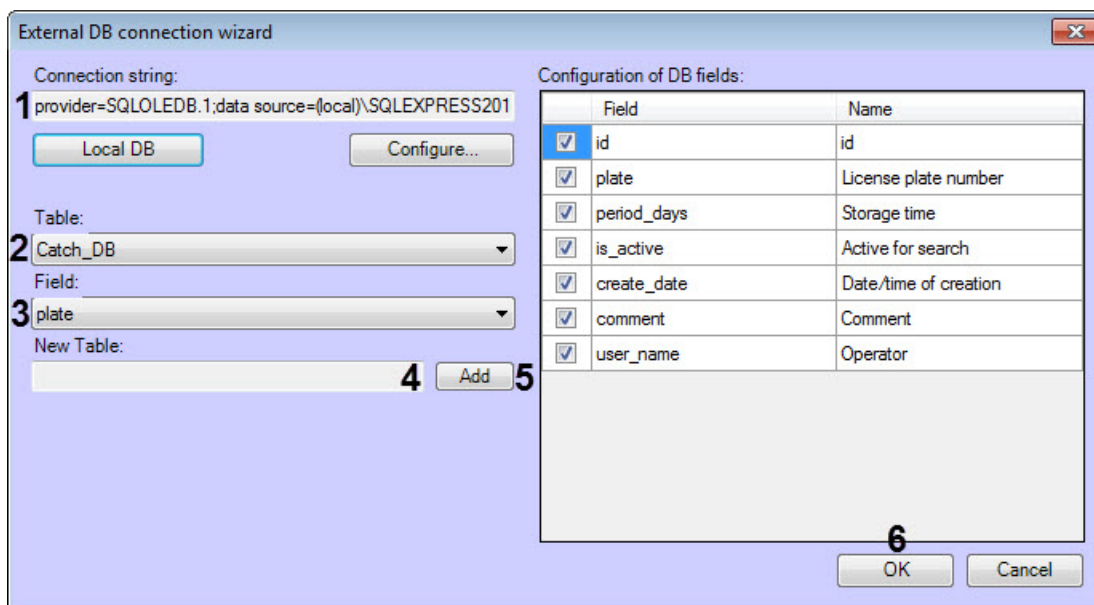

5. The **Table** drop-down list (2) contains the table names in the selected database. Select the table, containing the vehicle plates from this list.

Note

When connecting to the Active tracking database, select the **Catch_DB** value.

6. The **Field** drop-down list (3) contains the column names of the selected table. Select the column with vehicle plates from this list.

Note

When connecting to the Active tracking database, select the **Plate** value.

7. To add a new table to the selected database, enter the table name in the **New Table** field (4) and click the **Add** button (5).

Note

- The name of the new table should not contain numbers and be a reserved keyword of Microsoft SQL Server (for details, see [Reserved Keywords \(Transact-SQL\)](#)).
- The new table will have a structure similar to the one indicated in the **Table** drop-down list (2).

8. Click **OK** (6) to save the changes and close the **External DB connection wizard** dialog window.

Note.

To quit the **External DB connection wizard** without saving the changes, click **Cancel**.

9. As a result, the **Data source connecting string**, **Table** and **Field** fields (1) on the **External plates DB** object settings panel will be filled up.

The screenshot shows the 'External Plates DB 1' settings window. The 'Data source' section is highlighted with a black box and a '1' in the top right corner. The 'Data source connection string' field contains 'Provider=SQLOLEDB.1;Password=****;Persist Security Info=True;Use'. The 'Table' field contains 'Catch_DB' and the 'Field' field contains 'plate'. A 'Configuration' button is next to the field. The 'Search method' dropdown is set to 'Exact match'. The 'Partial LP match and template search return no more than:' section has a value of '5' and the text 'license plate numbers'. An 'Edit SQL-query...' button is at the bottom. The 'Apply' button at the bottom left is circled and labeled with a '2'.

10. Click **Apply** (2).

The External Plates database connection is completed.

5.2.16.2.3 Assigning names to table columns containing LP numbers

You can assign names to the table columns containing the vehicle LP numbers to be displayed in the **Vehicle Tracer** module interface window. The table columns will be displayed in this window if the search for a recognized license plate in the External Plates Database is successful.

To assign names to table columns, containing vehicle plates, do the following:

1. Go to the **External Plates DB** object settings panel.

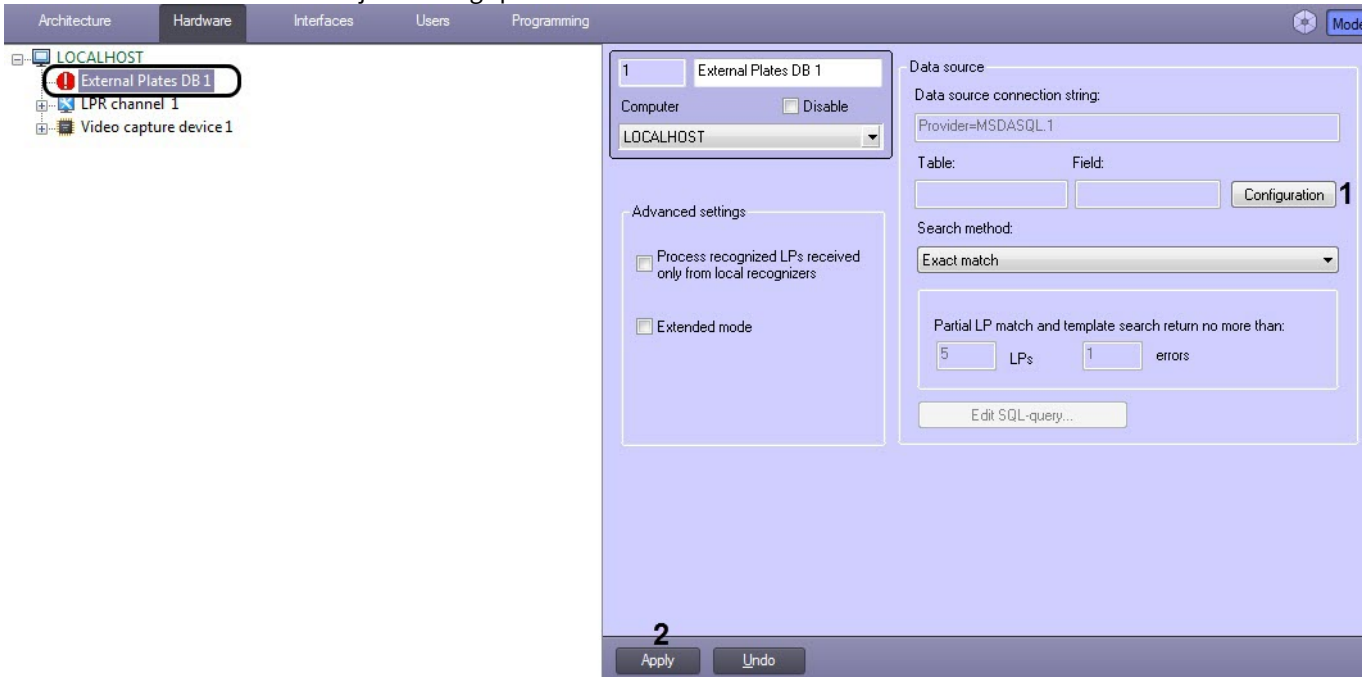

2. Click the **Configuration** button (1).
3. **External DB connection wizard** will be displayed in result.

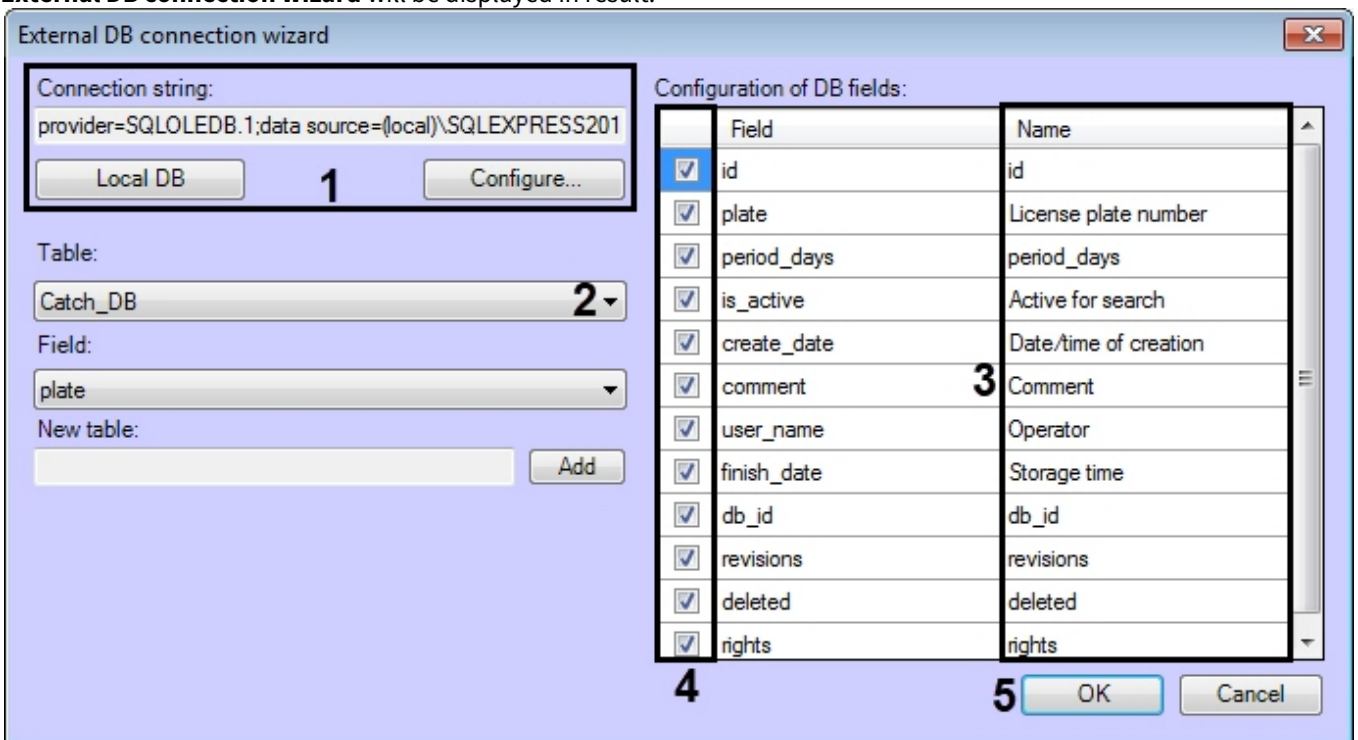

4. Set the connection string to the External DB (1) (see [External DB connection](#)).
5. From the **Table** drop-down list (2), select the table, containing vehicle plates. As a result, a list of columns in the selected table will be displayed in the **Configuration of DB fields** table (3).
6. In the **Name** column (3), enter the names corresponding to columns that will be displayed in the **Vehicle Tracer** interface window.
7. Set the check boxes for the strings (4) which fields should be displayed in the **Vehicle Tracer** interface window.
8. Click **OK** (5) to save the applied changes and close the dialog window **External DB connection wizard**.

Note.

Click **Cancel** to close the window **External DB connection wizard** without saving the changes.

9. Click **Apply (2)**.

Assigning names to table columns, containing vehicle plates, is completed.

5.2.16.2.4 Plates search method selection in the external plates database

Plates auto search in the External DB is performed by one of the following methods.

Search method	Method description	Search results displaying
Exact match	The same sequence of characters in the column with vehicle plates must correspond to a sequence of characters, corresponding to the identified vehicle plate.	The Vehicle Tracer window displays all table columns containing the vehicle numbers
Partial search	At least one sequence of characters, that is partially or in full present in the plate in the external BD must correspond to identified vehicle plate.	
Wildcard search	At least one of the plates, stored at external DB, must correspond to identified vehicle plate. Wildcards are recorded to the external BD preliminary together with vehicle plates. Wildcards in the DB are recorded according to Transact-SQL rules. Wildcards may contain usual characters and wildcards in the required combination.	
SQL-query	SQL-query is designed for extracting the required data from the table, containing plate's numbers and also from bound tables. SQL-query is used for more flexible setting up the Auto-Intellect PC (see Setting up SQL-query for plates search in the external database).	The Vehicle Tracer window displays the columns of the external database tables specified in the SQL query
With acceptable number of errors	The recognized number must correspond to at least one sequence of characters that is partially or completely contained in the number in the external plate database. You can select the maximum number of errors (mismatches of characters) in the number. <i>Note. The more errors are accepted, the more the search system is loaded.</i>	The Vehicle Tracer window displays all table columns containing the vehicle numbers

Wildcards Transact_SQL are presented in the following table.

Wildcard	Wildcard description	Example of search results
%	Any string with a length of zero or more characters	Plates, containing elements 'A', '385' and '78', divided by any number of characters, for example 'AO38578', 'A385MK78' correspond to the wildcard 'A%385%78'
_ (underlining)	Any single character	Plates, containing a sequence of 4 characters, the first of which is '2' and the last is '5' correspond to the wildcard '2__5', for example 'A256577', '2115OK43'
[]	Any single character contained in a range ([A-E]) or set ([ABCDE])	Plates, containing a sequence of 4 characters correspond to the wildcard '[E-M][2-5]53'. The sequence ends in '53', the first character belongs to the range E-M, the second one belongs to the range 2-5, for example 'K453MH02', 'm253BT63'
[^]	Any single character not contained in a range ([^A-E]) or set ([^ABCDE])	Plates, containing a sequence of 4 characters correspond to the wildcard '[^E-M]499'. The sequence ends in '499', the first character does not belong to the range E-M, for example 'B499BK57', 'H499578'

Note.

You can add numbers' templates through **Active tracking** database (see [Creating the Active tracking database](#)), or through DB editor (see official reference manual on required editor).

To select the search method of the identified plates in the external DB, do the following:

1. Go to the **External Plates DB** object settings panel (2).

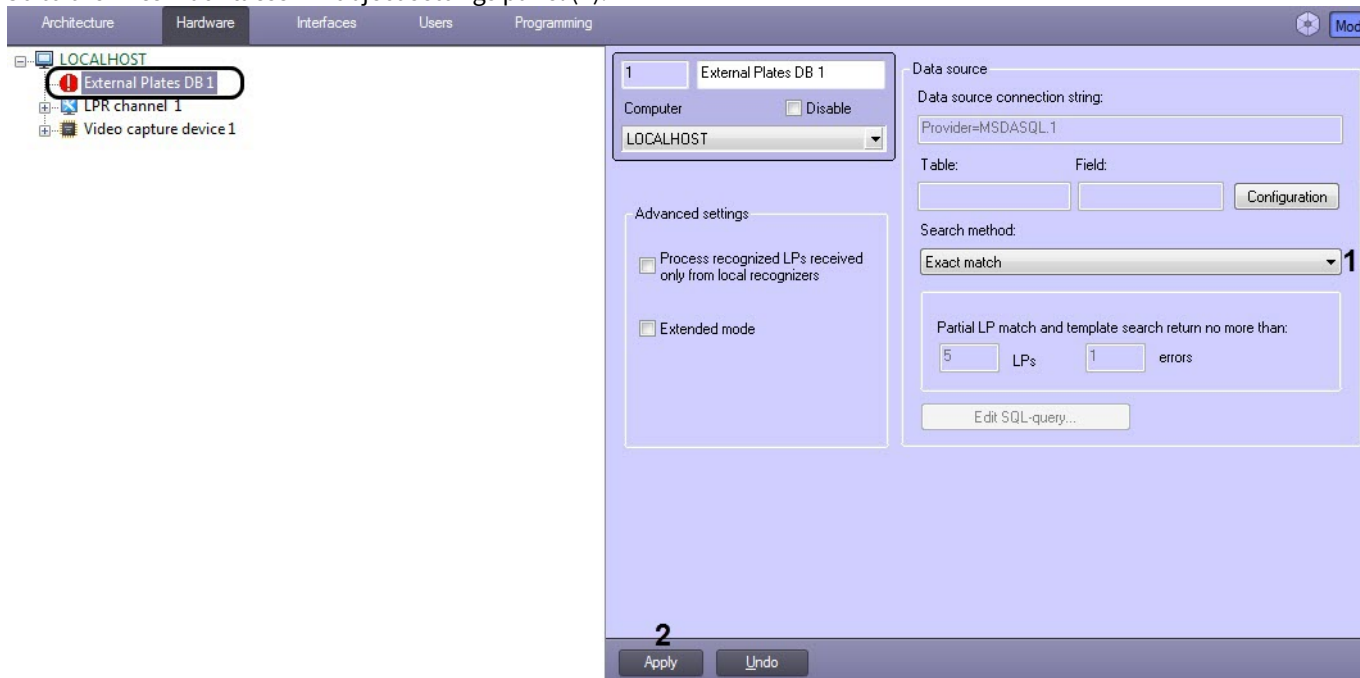

2. Select the required search method of the identified plates in the external DB from the list **Search method** (1).
3. Click **Apply** (2).

Selecting the search method of the identified plates in the external DB is completed.

5.2.16.2.5 Setting up the number of search results to be displayed

The **External Plates DB** module should be set to return a certain amount of LP numbers found in the database. This amount of numbers will be returned in case of partial search or wildcard search methods. This parameter is required for a more flexible setup of *Auto-Intellect* using the internal programming tools.

For setting the plates number to be returned while searching via a wildcard or a number's part, do the following:

1. Go to the **External Plates DB** object settings panel.

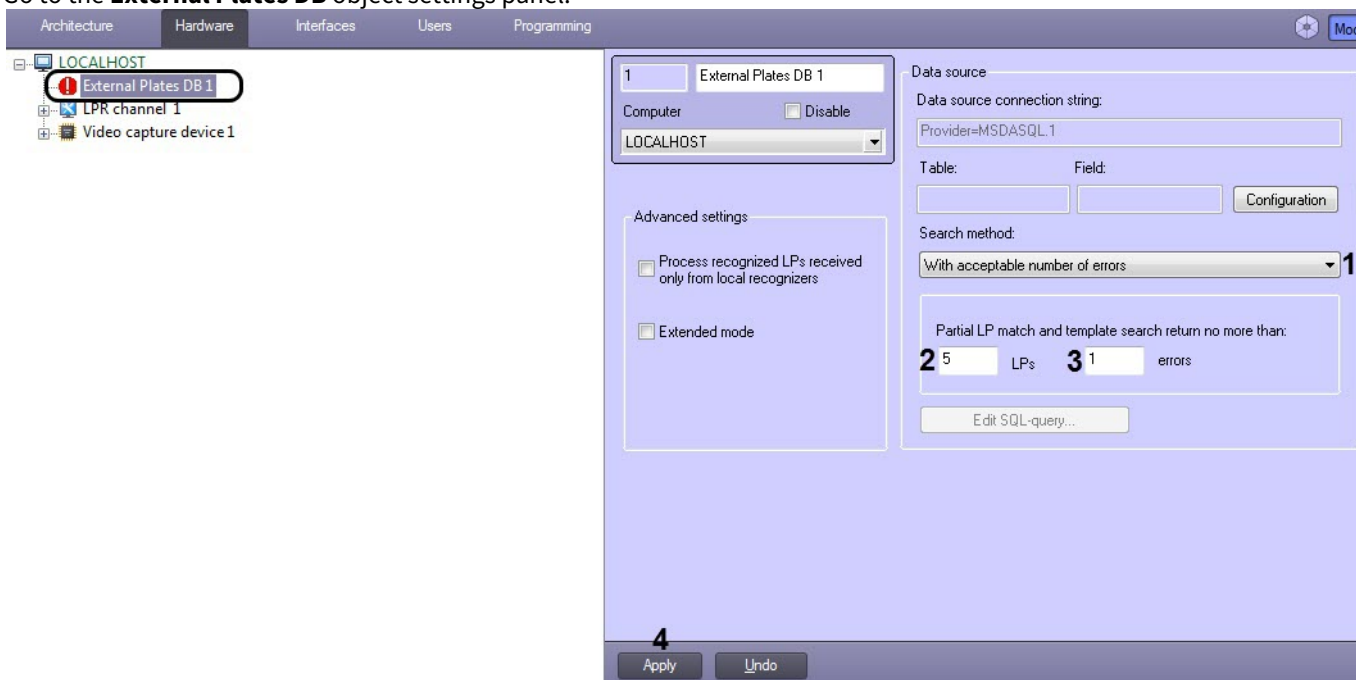

2. Select the value **Partial match, Wildcards match** or **With acceptable number of errors** from the **Search method** drop-down list (1).
3. In the **Partial LP match and template search return no more than** field:
 - **LPs (2)** — enter the maximum number of license plates returned when searching by part of the number or number template in the external plates database.

Note.

This parameter also affects the number of returned records in the **Event viewer** window when searching by template or by part of a number.

- **errors (3)** — enter the maximum number of errors (character mismatches) in the search request and numbers in the external plate database.

Note

The more errors are accepted, the more the search system is loaded.

4. Click **Apply (4)**.

Setting the plates number to be returned while searching via a wildcard or a number's part is completed.

5.2.16.2.6 Setting up SQL-query for plates search in the external database

There is a possibility to set SQL-query for extracting the required data from the table, containing plates and bound tables. The set SQL-query will be used while searching the plates in the external DB if the **SQL-query** search method is selected (see section [Plates search method selection in the external plates database](#)).

To set the SQL-query do the following:

1. Go to the **External Plates DB** object settings panel.

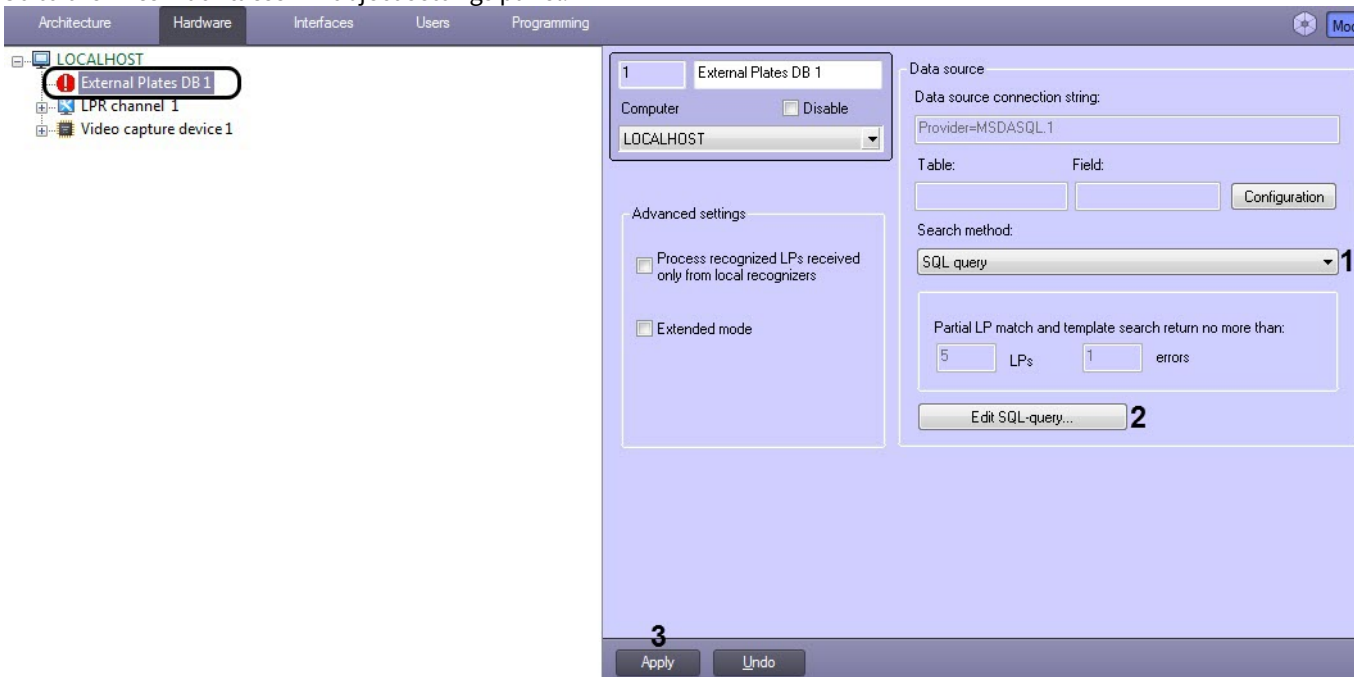

2. Select the **SQL query** value from the **Search method** list (1).
3. Click the **Edit SQL-query** button (2).
4. The **SQL-query configuration** dialog window will be displayed in result.

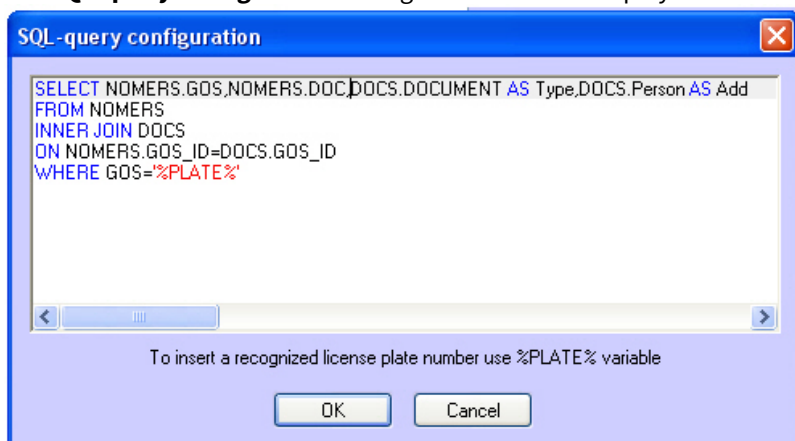

5. Enter SQL-query to extract (SELECT) the required data from the table, containing plates and bound tables. To replace the identified plate use the variable %PLATE%.

Note.
Detailed information concerning setting the SQL-queries is given in the corresponding reference manual.

Note.
SQL-query, given for example, returns the required columns from the external DB if the plate in this DB coincide with the identified number.

Example of extracting the data from external DB

Table	Table's column	Column's contain	Is returned in result of SQL-query
NOMERS	GOS_ID	Primary keys of NOMERS' table recordings	No

Table	Table's column	Column's contain	Is returned in result of SQL-query
	GOS	Plates	Yes
	DOC	Documents' keys, on the basis of which the plates have been recorded to the DB	Yes
	DATE	Dates, of entering the plates to DB	No
DOCS	DOC_ID	Primary keys of DOCS' table recordings	No
	DOCUMENT	Document types, on the basis of which the plates have been recorded to the DB	Yes
	PERSON	Persons, who entered the plates to the DB	Yes
	GOS_ID	External keys of DOCS' table recordings, used for connection to the NOMERS table	No



6. To save the changes and close the **SQL-query settings** dialog window click **OK**.

Note.

Click **Cancel** to close the dialog window **SQL-query settings** without saving the changes.

7. Click **Apply (3)**.

Setting up the SQL-query is completed.

5.2.16.2.7 Additional settings of the external plates database

To specify additional settings of external databae, do the following:

1. Go to the **External Plates DB** object settings panel (2).

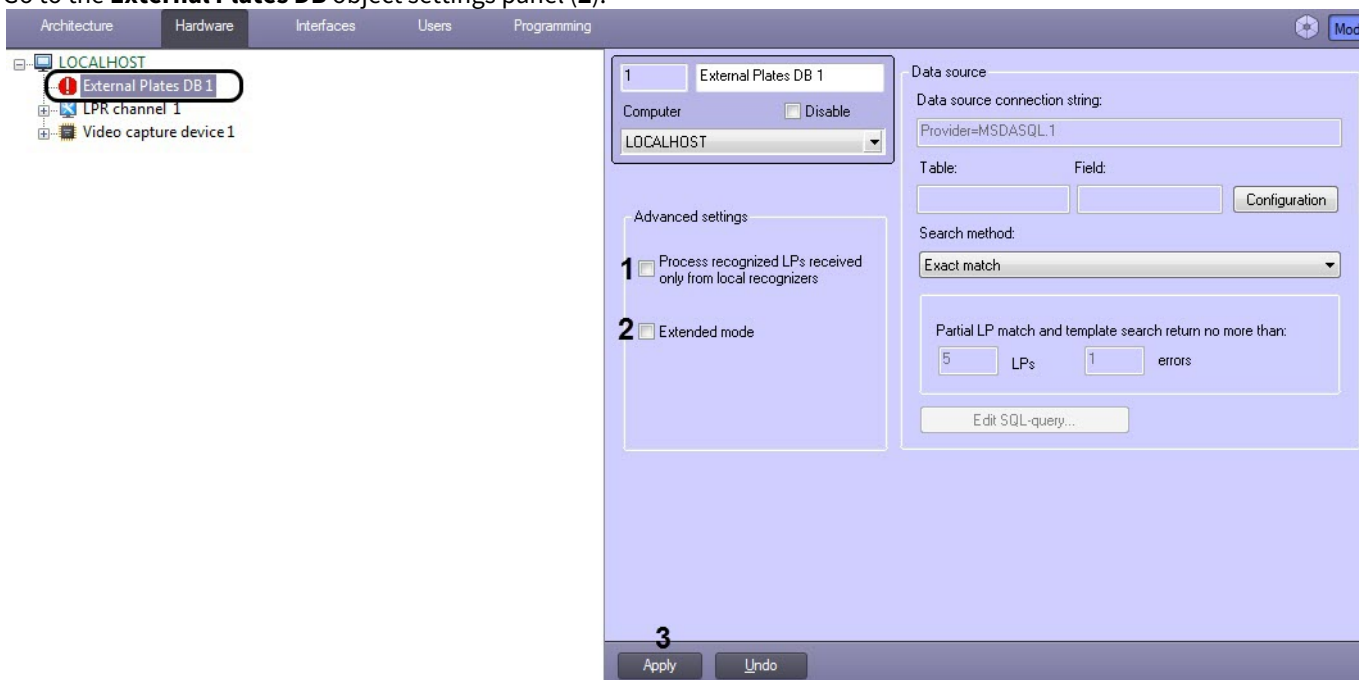

2. Set the **Process recognized LPs received only from local recognizers** checkbox if it is needed to use plates only from local recognizers while comparing with plates stored in the database (3).
3. Set the **Extended mode** checkbox to use the special procedure of recognizing violators in accordance with restrictions for licence plates depending on the week days (4). If this checkbox is set, then for identified license plates, which are not found in the database, the additional rules from the `lprdb_rules.xml` file are checked (or from the `lprdb_rules_X.xml`, where X stands for the ID of the **External Plates DB** object, if it is necessary to set extended mode separately for the External Plates DB). This file should be located in the `<Auto Intellect installation directory>\Modules\` folder. In this file the days of week and time intervals are specified, inside which vehicles with certain last digit of the license plates are forbidden to pass.

Note.

Example of the `lprdb_rules.xml` file. Such file is designed to forbid passage on Monday for the following vehicles:

1. With the last digit of the license plate equal to 1, in time interval from 12:00:00 PM to 4:00:00 PM and from 8:00:00 PM to 10:00:00 PM
2. With the last digit of the license plate equal to 8, in time interval from 10:00:00 PM to 13:00:00 PM

```
<LPRDB_Rules>
  <DayOfWeek value ='Monday'>  <! The day of week>
    <Alarm match='1'>      <! The last digit of the license plate>
      <Time from='12:00:00' to='16:00:00' />  <! Time interval>
      <Time from='20:00:00' to='22:00:00' />  <! Time interval>
    </Alarm>
    <Alarm match='8'>
      <Time from='22:00:00' to='23:00:00' />
    </Alarm>
  </DayOfWeek>
  <DayOfWeek value ='Tuesday'></DayOfWeek>
  <DayOfWeek value ='Wednesday'></DayOfWeek>
  <DayOfWeek value ='Thursday'></DayOfWeek>
  <DayOfWeek value ='Friday'></DayOfWeek>
  <DayOfWeek value ='Saturday'></DayOfWeek>
  <DayOfWeek value ='Sunday'></DayOfWeek>
</LPRDB_Rules>
```

4. To save changes click **Apply** (5).

Specifying the additional settings of external database is completed.

5.2.16.3 LP database replication

The LP database replication is used in a distributed configuration with several Servers, so that when new LPs are added from the LP database of the selected Server (the replication source), the same LPs are automatically added to the external LP database of another Server in the distributed configuration. Also, when the LP database replication is enabled, the changes/deletions of LPs in the selected external LP databases (the replication source) are also synchronized with other Servers.

Note

The LP database is synchronized in the background every 10 seconds.

LP database replication is configured as follows:

1. Configure the **External Plates DB** module (see [Connecting and setting up of the external LP number database](#)).
2. Create the **LP database replication** object on the basis of the **External Plates DB** object.

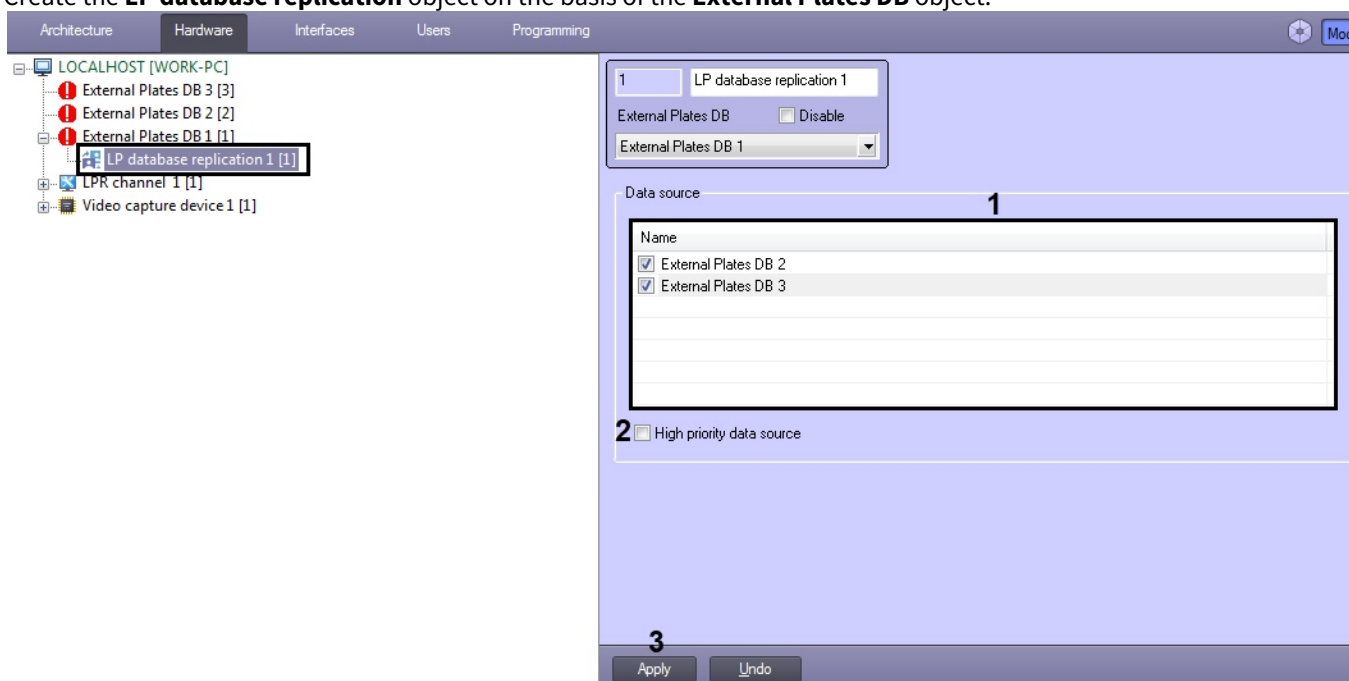

3. In the **Data source** list (1), set the checkboxes for the external Plates DBs, the LP from which will be replicated to the external Plates DB on the current Server.
4. Set the **High priority data source** checkbox (2) so that in case of changing/deleting the LPs in the external plates DB of the current Server, the LPs are replaced with data from the external plates DB from which replication is carried out. If the checkbox is unset, then when changing/deleting LPs in the external plates DB of the current Server, these LPs will be saved even after replication.
5. Click **Apply** (3) to save the settings.

5.2.17 Remote recognition

5.2.17.1 The Remote recognition module functionality

The **Remote recognition** module is designed to implement the following functions:

- Working with cameras with the LP recognition function;
- Working with cameras with the vehicle speed detection function;
- Recording the LP recognition and vehicle speed detection events to the database.

The LP recognition is supported by Tattile, ARH, GIT, and other manufacturers. The vehicle speed detection is supported by the GIT-CNW25060/BUR(L) camera by GIT.

See the [Drivers Pack documentation](#) for a complete list of supported cameras.

The list of supported countries for Tattile cameras can be found on the manufacturer's [website](#).

5.2.17.2 Configuring the cameras with LP recognition and vehicle speed detection

A general way to configure a camera with the license plate number recognition and vehicle speed detection functions is as follows:

1. Add a camera via the [Camera discovery tool](#) or manually (see [Configuring video acquisition from IP devices](#)).
2. If a camera was created manually, then you need to create an **Embedded detector** object on the basis of the **Camera** object and configure it as follows:
 - a. Go to the **Embedded detector** object settings panel.

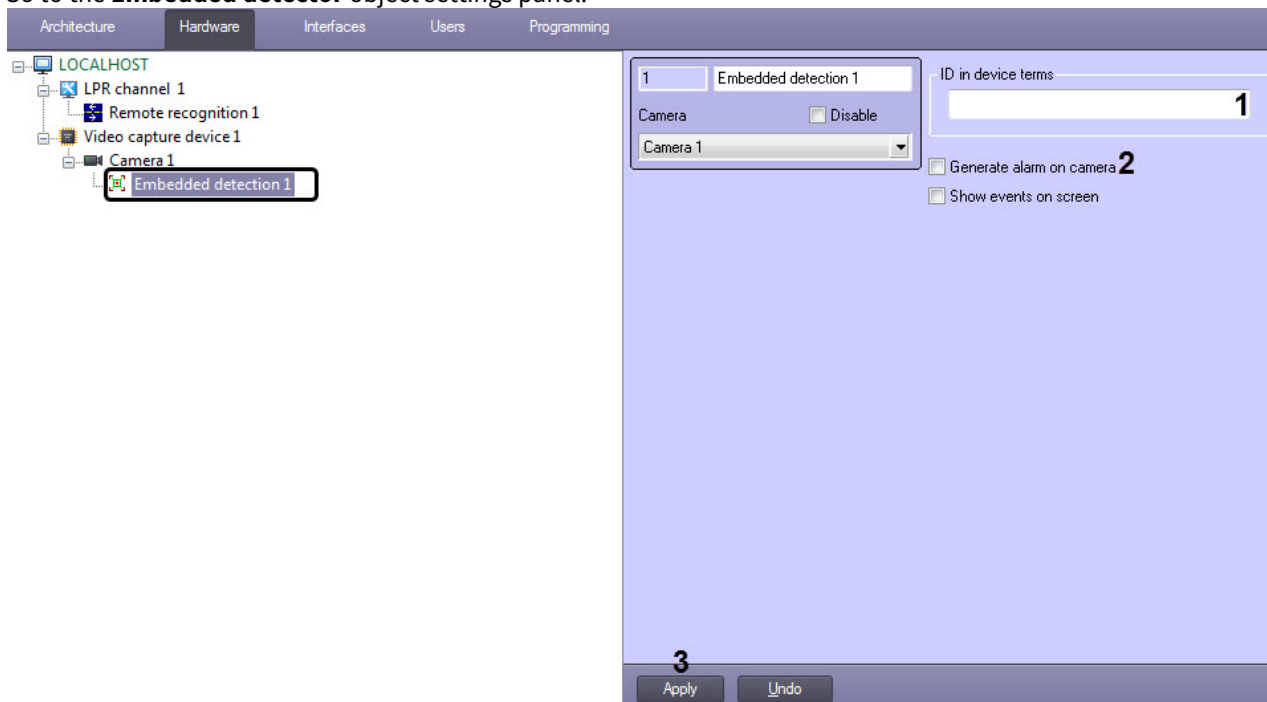

- b. In the **id in device terms** field (1), specify the required value:
 - **lpr_detection** - the id for working with a camera with a LP number recognition function;
 - **radar_detection** - the id for working with a camera with a vehicle speed detection function.

Attention!

- The id may differ from the specified one depending on the camera model.
- If the camera supports both the LP number recognition and the vehicle speed detection, then for their simultaneous operation, it is necessary to create an **Embedded detector** object for each function and specify the id of the corresponding one.

- c. Set the **Generate alarm on camera** checkbox (2) if the alarm should be generated on the camera by detector's response.
- d. Click the **Apply** button to save the changes (3).

3. Create the **Remote recognition** object on the basis of the **LPR channel** object and configure the LPR channel object (see [Activating the software module used for identifying the plates](#)).

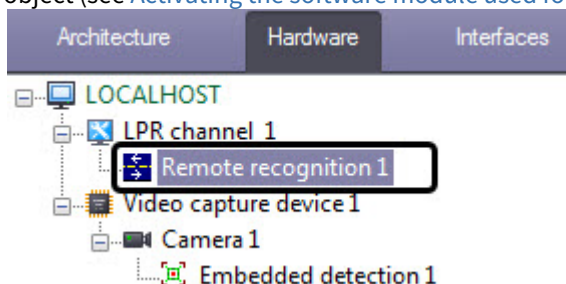

4. In order for the LP recognition and vehicle speed detection events to be displayed in the user interface, it is necessary to create and configure the **Monitor** and **Vehicle Tracer** objects on the **Interfaces** tab (see [The Vehicle Tracer interface module](#)).

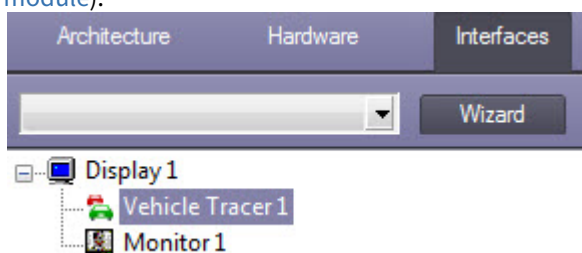

Note

If there are no data on the recognized LPs displayed in the Active Monitor of the *Auto Intellect* — although they are found in the Debug window and Event protocol — it is necessary to change the **RemoteLpr.x.NearestTime** registry key value. **X** is the identifier of the **LPR channel** object in the **Intellect** software on which the remote recognition module is used (for more details, see [Registry keys reference guide](#), for more information about working with the registry, see [Working with Windows OS registry](#)).
The **RemoteLpr.x.NeatestTime** registry key value can also be changed by the Debug window (see [Editing the Nearest Time for the specified remote recognition module](#)).

5. Go to the camera web-interface and configure the camera in a way necessary to achieve the stable license plate number recognition and vehicle speed detection, which meets the requirements.

Configuring the cameras with LP recognition and vehicle speed detection in a general way is complete.

5.2.17.2.1 Configuring VEGA Access and VEGA III cameras by Tattile

Configuring the VEGA Access and VEGA III cameras by the Tattile manufacturer is performed the following way:

- Go to the **Plate reader** tab in the camera settings program and select the **General** item of menu. From the **Acquisition Mode** drop-down list select the **FREE_RUN** value to send data by camera.

VEGA - Automatic Number Plate Reader

General Settings

Enable Engine

 Acquisition Mode

 Site Address

 TCP message after FTP Actions

 Maximum fps

 Filter static plates

Warning: Changes in Acquisition Mode will briefly interrupt this browser connection. Refresh this screen to reconnect.
 Warning: When you click on shut down button you have to reboot or switch off the device.

www.tattile.com

- In the **Plate reader** tab select the **Events/Actions settings**.

VEGA - Automatic Number Plate Reader

Events/Actions Settings

Actions / Events	Send Image FTP	Save DB FTP	GM Alarm	Pulse Out	Com232 Message	Com485 Message	TCP Message	Send Image FTP 2	Save DB FTP 2	TCP Message 2	SD Saving
Ocr Read	<input type="checkbox"/>	<input type="checkbox"/>	<input type="checkbox"/>	<input type="checkbox"/>	<input type="checkbox"/>	<input type="checkbox"/>	<input checked="" type="checkbox"/>	<input type="checkbox"/>	<input type="checkbox"/>	<input type="checkbox"/>	<input type="checkbox"/>
Ocr Not Read	<input type="checkbox"/>	<input type="checkbox"/>	<input type="checkbox"/>	<input type="checkbox"/>	<input type="checkbox"/>	<input type="checkbox"/>	<input checked="" type="checkbox"/>	<input type="checkbox"/>	<input type="checkbox"/>	<input type="checkbox"/>	<input type="checkbox"/>
Ocr No Plate	<input type="checkbox"/>	<input type="checkbox"/>	<input type="checkbox"/>	<input type="checkbox"/>	<input type="checkbox"/>	<input type="checkbox"/>	<input checked="" type="checkbox"/>	<input type="checkbox"/>	<input type="checkbox"/>	<input type="checkbox"/>	<input type="checkbox"/>
Match On List A	<input type="checkbox"/>	<input type="checkbox"/>	<input type="checkbox"/>	<input type="checkbox"/>	<input type="checkbox"/>	<input type="checkbox"/>	<input type="checkbox"/>	<input type="checkbox"/>	<input type="checkbox"/>	<input type="checkbox"/>	<input type="checkbox"/>
No Match On List A	<input type="checkbox"/>	<input type="checkbox"/>	<input type="checkbox"/>	<input type="checkbox"/>	<input type="checkbox"/>	<input type="checkbox"/>	<input type="checkbox"/>	<input type="checkbox"/>	<input type="checkbox"/>	<input type="checkbox"/>	<input type="checkbox"/>
Match On List B	<input type="checkbox"/>	<input type="checkbox"/>	<input type="checkbox"/>	<input type="checkbox"/>	<input type="checkbox"/>	<input type="checkbox"/>	<input type="checkbox"/>	<input type="checkbox"/>	<input type="checkbox"/>	<input type="checkbox"/>	<input type="checkbox"/>
No Match On List B	<input type="checkbox"/>	<input type="checkbox"/>	<input type="checkbox"/>	<input type="checkbox"/>	<input type="checkbox"/>	<input type="checkbox"/>	<input type="checkbox"/>	<input type="checkbox"/>	<input type="checkbox"/>	<input type="checkbox"/>	<input type="checkbox"/>
Start Trigger				<input type="checkbox"/>							
Stop Trigger				<input type="checkbox"/>							
System Alarm		<input type="checkbox"/>	<input type="checkbox"/>	<input type="checkbox"/>	<input type="checkbox"/>	<input type="checkbox"/>	<input type="checkbox"/>		<input type="checkbox"/>	<input type="checkbox"/>	

www.tattile.com

3. In the displayed list click the **TCP Message (Ocr Read)** parameter and configure it the following way in the opened box.

VEGA - Automatic Number Plate Reader

TCP Message on Ocr Read

Enable: YES
 Message format: STANDARD
 Message: %DATE%TIME%PLATE%PLATE_COUNTRY%OCRSCORE%
 Jpeg Quality: 75
 Crop Image(*): PLATE
 Server IP: 77.246.233.102
 Server Port: 32000
 Reuse Connection: YES
 Buffering on SD: NO

[HELP](#)
[JPEG](#)
[HEADER](#)

[Previous Page](#)

www.tattile.com

3.1 Enter the whole list of metadata in the **Message** field considering the follows:

specify **IMAGE_BW** to send frames by camera;

only plates will be observed at minimum resolution;

specify a date and time in the list to send time intervals to the database.

At the moment of writing the document the following types are supported:

%DATE%TIME%PLATE_STRING%PLATE_COUNTRY%OCRSCORE%SPEED%CLASS%DIRECTION%IMAGE_BW%PLATE_MIN_X%PLATE_MIN_Y%PLATE_MAX_X%PLATE_MAX_Y.

3.2 Enter the IP address of the computer with installed *Auto-Intellect* software in the **Server IP** field;

3.3 Enter the number of port at which data will be sent in the **Server Port** field. The fixed port for the Intellect software package is 32000. Ensure that this port is not used by other processes.

After the required settings are performed, create and configure the corresponding objects in the *Auto-Intellect* software package:

1. Go to the **Hardware** tab of the **Settings** dialog box of the *Auto-Intellect* software. Create the **Video Capture Device** on the base of **Computer** object. In the right part of **Hardware** tab the settings panel will display.

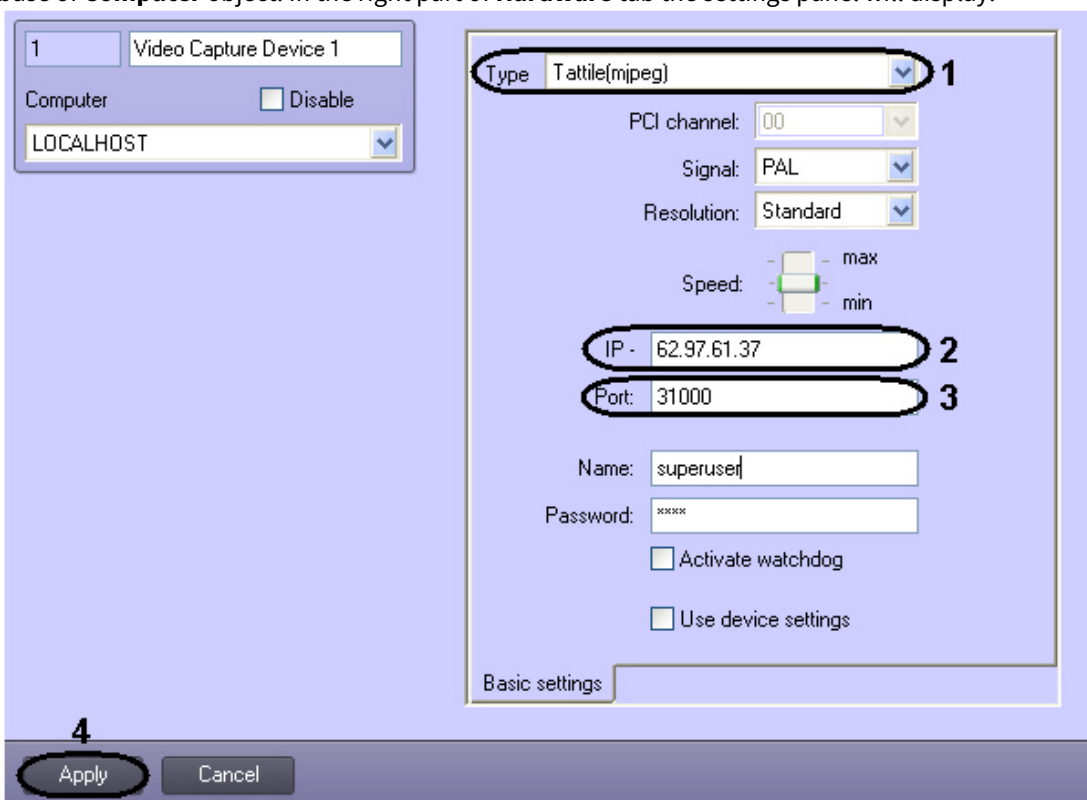

2. Select the type of configured camera in the **Type** drop-down list (1).
3. Enter the IP address of connected device in the **IP address** field (2).
4. Enter the number of port in the **Port** field (3). Default number of port is 31000.
5. To save changes click the **Apply** button (4).

To enable the remote identifier operation, do the following:

1. Create the **Embedded detection** object on the base of **Camera** object. Enter the **anpr-detector** value in the **ID in device terms** field.



2. To save changes click the **Apply** button.

Notes

- For license plates identification in the *Auto-Intellect*, create the **Remote recognition** object on the base of the **LPR channel** object and configure the **LPR channel** object (see [Activating the software module used for identifying the plates](#)).
- In order for the uploaded frames and events to be displayed in the user interface, it is necessary to create and configure the **Monitor** and **Vehicle Tracer** objects on the **Interfaces** tab (see [The Vehicle Tracer interface module](#)).

Configuring of VEGA Access and VEGA III cameras by Tattile manufacturer for working with the *Auto-Intellect* software package is completed.

Note.

The camera will send frames and metadata while the detector operation. If the **Color** mode is selected in the camera settings program, then the camera will send 2 photos:

- black and white - to display the license plate;
- color - to display a frame of the vehicle's video image.

5.2.18 Traffic violations detection

5.2.18.1 Video camera mounting and setup requirements for the Traffic violations detection

The following camera functions should be disabled:

1. Video information accumulation mode / night mode;
2. Permanent automatic image sharpness adjustment;
3. Motion detectors;
4. Any information from the camera (name, date, time, etc) inserted in the video image.

Basic characteristics of used video cameras are presented in the [General requirements for mounting and configuring of cameras](#) section.

Note.

Digital video cameras also can be in use for working with the **Traffic violations detection** module. Testing with IP-cameras is not be performed.

Note.

There are no any limitations for fps for the **Traffic violations detection** module.

5.2.18.2 The Traffic violations detection functionality

The **Traffic violations detection** module is designed for identifying vehicles that have passed on the red light. Identifying is performed in real time.

The **Traffic violations detection** module supports the following functionality:

1. Setting the alarm when the red light passing is detected.
2. Setting the alarm when the vehicle going through the stop line on the red light.
3. Setting the alarm when the vehicle stops over the crosswalk line on the stoplight.
4. Registering the events in the database.

Attention!

The **Traffic violations detection** is in full operation with the **AUTO-Uragan**, **VIT**, **LPR IntelliVision** and **RoadAR** recognition modules. Only the **Red light violation** will be recognized while join operation of the **Traffic violations detection** module and the **CARMEN-Auto** recognition module. Other violations will be inaccessible.

5.2.18.3 Setting up the Traffic violations detection module

For the **Traffic violations detection** module operation program module for identifying the plates and that is being set up is required (see [Activating the program module, used for identifying the plates](#) section).

Attention!

For correct operation of the **Traffic violations detection** module configure the synchronous video camera from which frames and video fragments will be saved (detailed information about configuring the synchronous video camera is presented in the [Selecting the video cameras to work with the LPR channel](#) page).

To set the **Traffic violations detection** module, do the following:

1. Go to **Traffic violations detection** object settings panel, which is created on the basis of **LPR channel** object.

The screenshot shows the configuration interface for the Traffic violations detection module. It features several input fields and buttons:

- 1**: Traffic violations detection 1 (Title)
- LPR channel**: LPR channel 1 (Dropdown)
- Traffic lights signal**: Sensor 1 (Dropdown, labeled **1**)
- Alarm direction**: Basic (Dropdown, labeled **2**)
- Draw stop line**: (Checkbox, labeled **3**)
- 4**: Stop line settings (Button)
- 5**: Setting violation areas (Button)
- 6**: Delay in violation registering: 1000 ms (Field)
- 7**: Time of stop for recording: 3000 ms (Field)
- 10**: Number of pictures to trace alarm: 3 (Field)
- Red light violation** section:
 - 8**: Add.photos: 2 (Field)
 - 9**: Interval: 1000 ms (Field)
- Additional recognizers**: A table with columns: LPR channel, Sensor, State, Alarm type (labeled **11**). The table is currently empty.
- Apply** and **Cancel** buttons at the bottom.

2. In **Traffic lights signal** dropdown list select the object (**Sensor** or **Traffic Light Detection**) by signal of which the light of traffic light is detected (**1**).

Note.

Information about **Sensor** object is presented in the [Creating and configuring the Sensor system object](#) section. Information about **Traffic Light Detection** module is presented in **Detector Pack. User's Manual** document (see [Detector Pack](#)).

Attention!

For correct operation of the **Traffic violations detection** module disarm the corresponding **Sensor** object.

3. From the **Alarm direction** dropdown list select the signal of traffic light detection on which the traffic violations detection is to be responded (**2**).
 - a. Basic - to fix violation use the base signal of the traffic light.
 - b. Left - to fix violation use the left arrow of the traffic light.
 - c. Right - to fix violation use the right arrow of the traffic light.
4. Set the **Draw stop line** checkbox if it's necessary to overlay a stop line before the traffic light (**3**).
5. Set up the stop line displaying:
 - 5.1 Click **Stop line settings** (**4**). The window of the same name opens.



5.2 Click **Stop video** to set the stop line. As the result the frame on which it's necessary to set the stop line, is displayed.

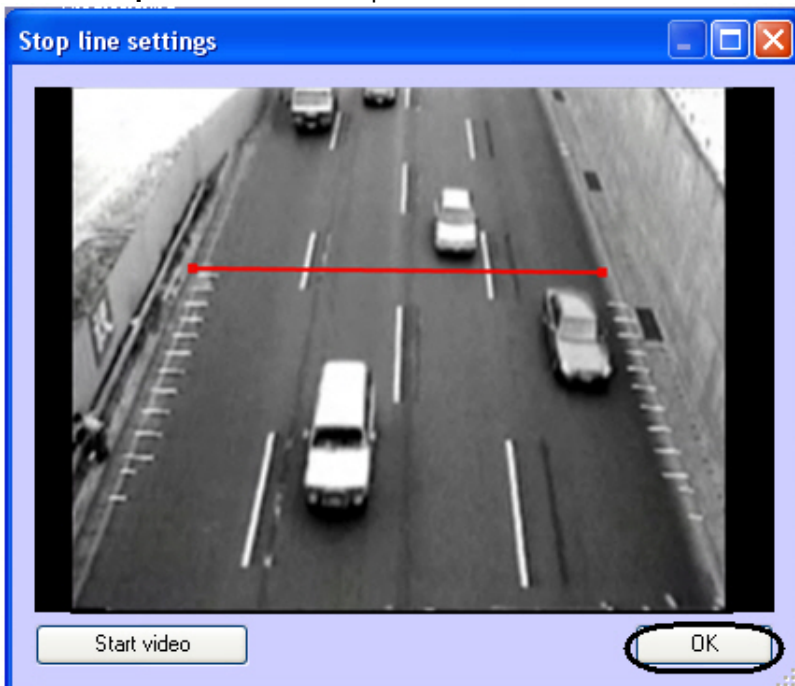

5.3 Set the stop line. To set the stop line, click the road edge in the image, press the left mouse button, drag the cursor to another edge of the road in the video frame.

5.4 Click **OK**.

6. Set up the displaying of violation areas:

6.1 Click **Setting violation areas (5)**. The window of the same name opens.

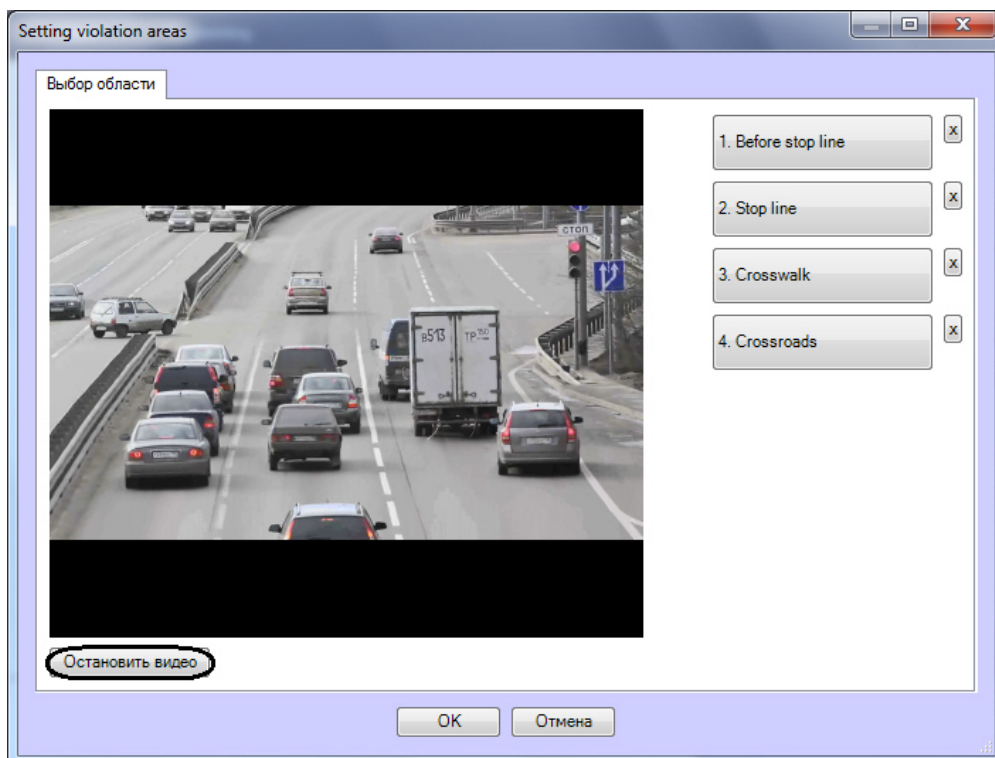

6.2 Click **Stop video** to set the violation areas. As the result the frame on which it's necessary to set the violation areas, is displayed.

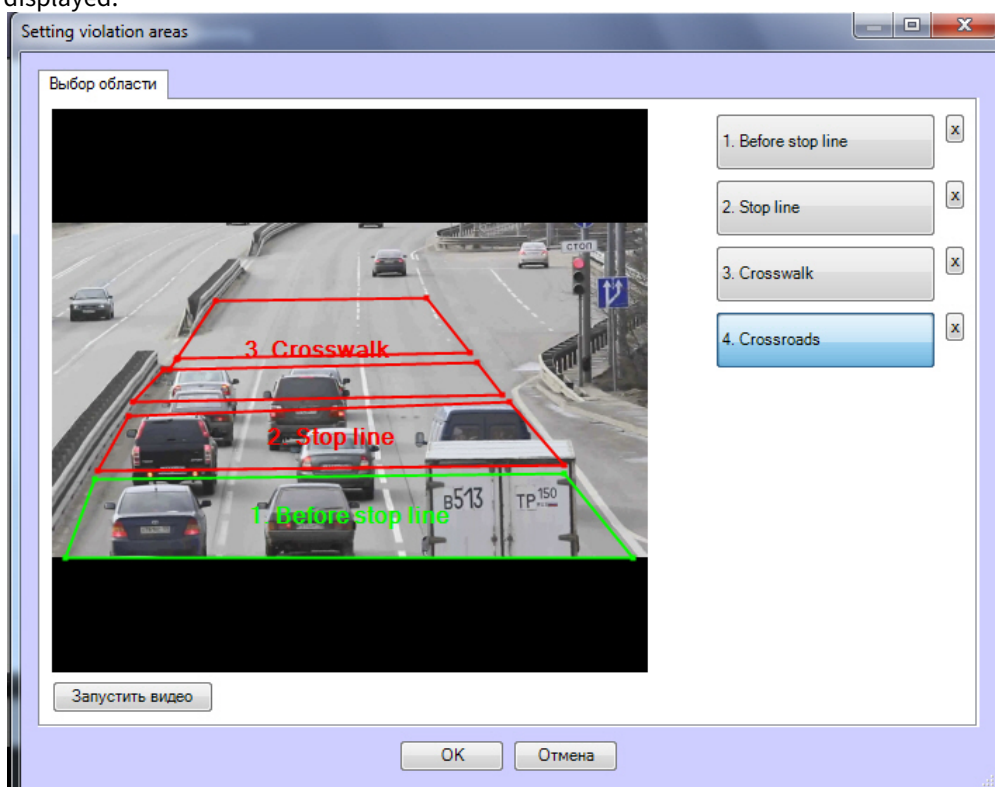

6.3 Set the areas corresponding to following zones: before stop line, stop line, crosswalk, crossroads. To set the violation areas, click the points corresponding to the boarder of selected area in the video frame.

6.4 Click **OK**.

Note.

To remove the area click the  button close to the corresponding button.

7. In the **Delay in violation registering** field enter time (in milliseconds) that determines the time interval after which after switching on a red light the violations will fix (6).
8. In the **Time of stop for recording** field enter time (in milliseconds) that determines the time interval during which the vehicle should stay still while registering the **Stop over crosswalk line** violation (7).

Note

If the **Stop over crosswalk line** violation is registered incorrectly, you can change the values of the registry key parameters that affect its accuracy. Changing the registry key parameters values enables the alarm activation even if only one plate is recognized at the crosswalk, regardless of the vehicle movement. To do this, change the **Alarms.CrossWalkOne** and **Alarms.LimitedByBestResult** values to **1** (for details, see [Registry keys reference guide](#) and [Working with Windows OS registry](#)).

9. In the **Number of pictures to trace alarm** field specify number of photos which will be stored from the moment of LP recognizing on the base recognizer to the moment of LP recognizing on the additional recognizer (10).
10. In the **Add.photos** field enter the number of photos made before the licence plate fixing and after its going out the control zone (8).
11. In the **Interval** field enter time (in milliseconds) that determines the time interval between saving additional photos (9).

Attention!

For correct operation of synchronized frames recording set the checkbox in **Automatic recording on LPR channel** object setting panel and set value of time that is bigger than the product of **Number of frames for saving** and **Interval of frame saving** parameter points.

12. In the **Additional recognizers** table specify additional LPR channels if it's required to use them along with the base recognizer (11).
 - a. To add additional recognizer right-click in the **Additional recognizers** list, then click **Add** in the drop-down menu.

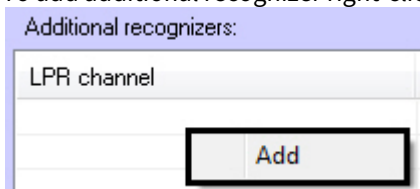

- b. From the **LP recognition** drop-down list select the additional recognizer (1).

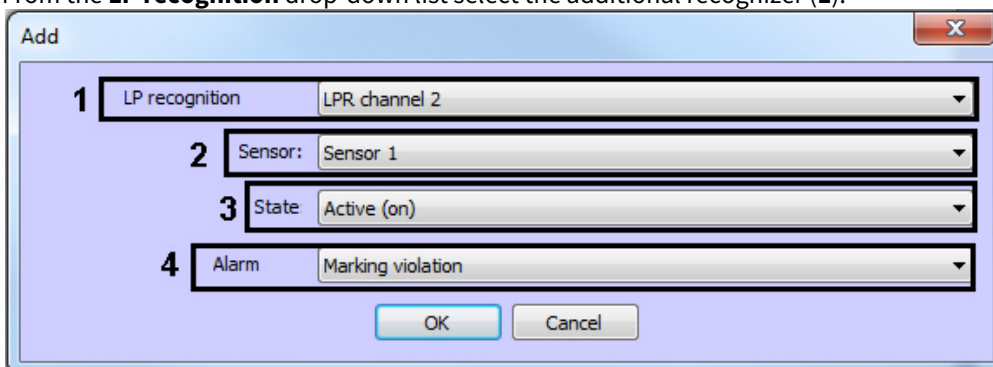

- c. From the **Sensor:** drop-down list select the sensor which will send events about traffic light operation (2).
 - d. From the **State** drop-down list select event from the sensor on which violation will be fixed (3).
 - e. From the **Alarm** drop-down list select the corresponding type of violation (4).

- f. Click **OK**. The specified parameters will be added to the **Additional recognizer** table.

Additional recognizers:			
LPR channel	Sensor	State	Alarm type
LPR channel 2	Sensor 1	Active (on)	Marking violation

Note.

To modify recognizers in the table, right-click the required recognizer to open the functional menu. Click **Delete all** button if the **Additional recognizers** table is to be cleared.

13. To save the changes click **Apply**.

Note

The recognition results can be saved to the hard drive for the **Traffic violations detection** module debugging. To do this, change the **SaveRecognitionResult** registry key parameter value to **1** (for details, see [Registry keys reference guide](#) and [Working with Windows OS registry](#))

The **Traffic violations detection** module setup is complete.

Logic of working the Traffic violation detection is explained in the following example.

Example. The vehicle is going from zone 1 to zone 2. **Crossing over stop line** violation will be registered in case of the vehicle is not crossing the border of zone 3 during the delay in violation registering. Checking for **Stop over crosswalk line** violation is performed in case of vehicle is crossing the border of zone 3. In such case vehicle stay still during the time of stop for recording and **Stop over crosswalk line** violation is registered or the vehicle is crossing the border of zone 4 and **Crossing over crossroads on red light** violation is registered.

The installation diagram of video cameras for violations detections by all directions of signaled crossing depending on the number of lanes is follows.

Several cameras are used for this purpose:

- Main camera - by one on each lane focused on the crossing and they detect and recognize license plates of vehicles entered to the crossing. Vehicles are moving to cameras.

- Additional, overview camera directed behind vehicles entered to the crossing (vehicles are moving from the camera). The traffic light with the red signal is also in the field of camera view.

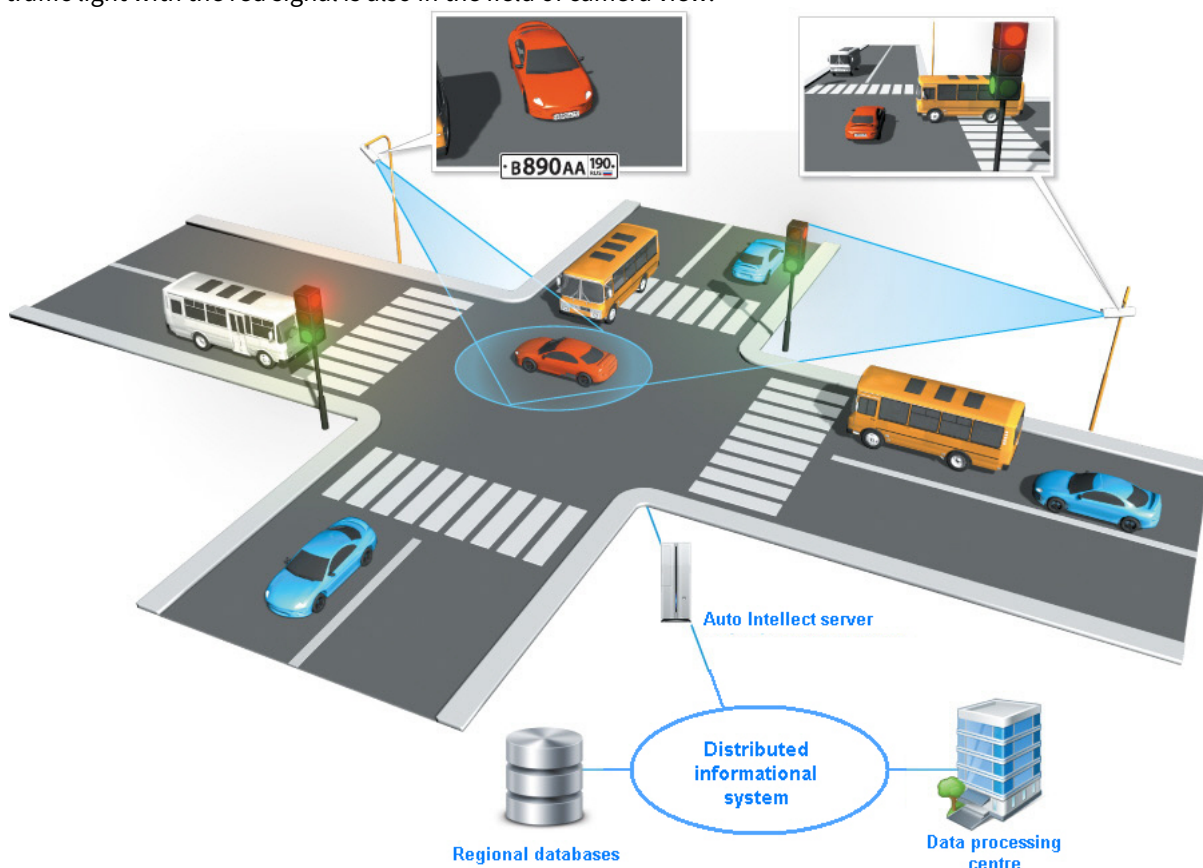

The *Auto-Intellect* software package receives signal from traffic light controller that the red signal enabled. After this signal record by all cameras started. For each vehicle entered to the crossing the following are detected:

- image of vehicle and its license plate;
- recognized vehicle LP (in the text mode);
- image confirming that the red signal is enabled and vehicle is located on the forbidden place is detected by additional, overview camera.

The *Auto-intellect* software package allows combining of unlimited number of crossings in the one photo-video detection system of moving on the red signal of traffic light. Data about all detected violations on all crossings are automatically passing to the integrated database.

5.2.19 Parking violation detection

5.2.19.1 The Parking violation detection functionality

The **Parking violation detection** module is designed for identifying vehicles violated forbidding of stop during time interval exceeding the allowable interval. Allowable time of vehicle stop is specified in the settings panel of the **Parking violation detection** object.

5.2.19.2 Setting up the Parking violation detection module

The **Parking violation detection** module requires any customized software module for the license plate recognition (see [Activating the software module used for identifying the plates](#) section).

To set the **Parking violation detection** module, do the following:

1. Go to the settings panel of the **Parking violation detection** object, which is created on the basis of **LPR channel** object.

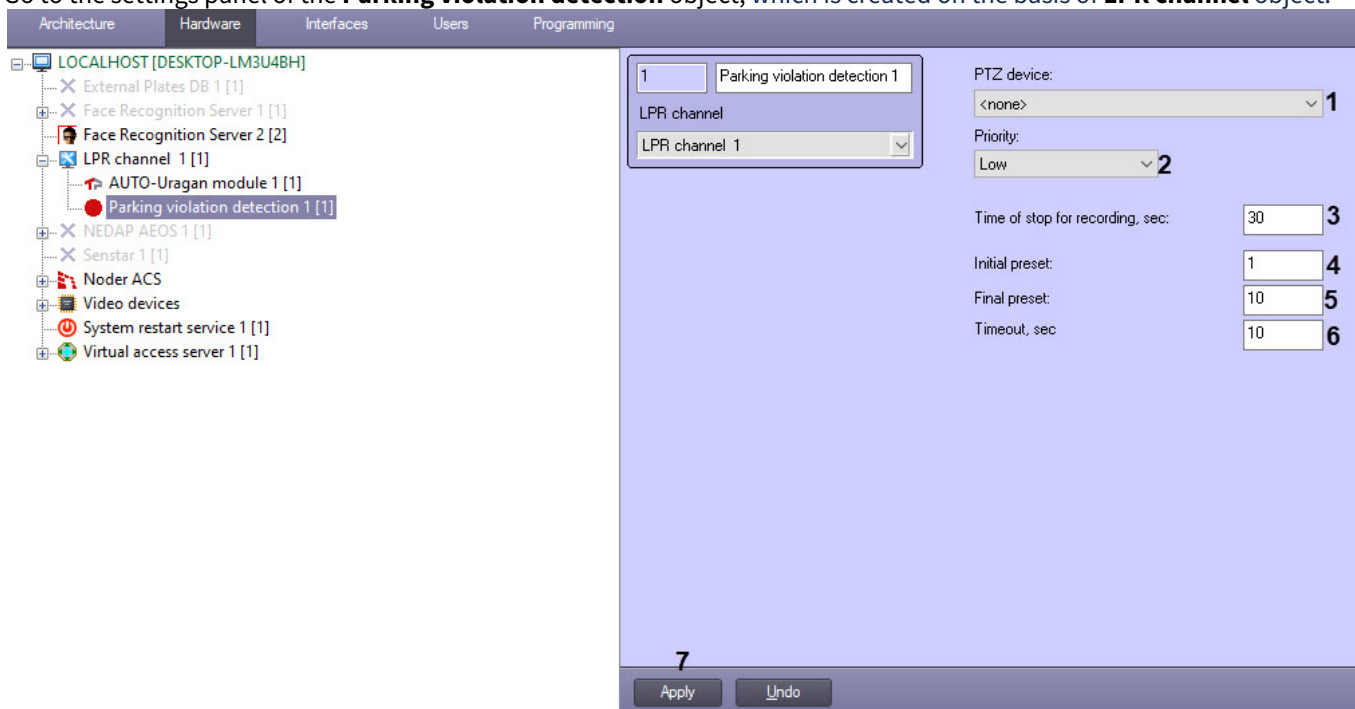

2. From the **PTZ device** drop-down list select the ptz device which will perform the passage between presets (1). For details, see [Configuring PTZ devices in INTELLECT™](#).
3. From the **Priority** drop-down list select the prz priority (2). If the selected priority is higher than the priority of the telemetry console, then the operator will lose control and the camera will turn to the parked vehicle.
4. In the **Time of stop for recording, sec** field enter the time interval in seconds during which the vehicle can be in the frame (3). When the vehicle get into the frame, it's license plate is recognizing. If the recognized license plate is in the frame of the same preset more than specified time, the **Parking violation** alarm is generated.
5. In the **Initial preset** field enter the number of preset from which monitoring will start (4).
6. In the **Final preset** field enter the number of preset on which monitoring will finish (5).
7. In the **Timeout, sec** field enter the time interval in seconds after which passage to the next preset will be performed (6).
8. Click **Apply** to save the changes (7).

Configuring of the **Parking violation detection** is completed.

5.2.20 Traffic Detection

5.2.20.1 The Traffic Detection module functionality

The **Traffic Detection** software module is designed for determining general characteristics of the traffic, as well as of each vehicle's parameters.

It supports the following functionality:

1. Determining the overall number of vehicles that passed in each lane.
2. Saving the date and time of vehicle registration.
3. Determining the class of the vehicle.
4. Calculating the total number of vehicles of each class.
5. Determining the speed of the vehicle (using the video image processing algorithm).
6. Determining the speed of the vehicles moving along a specified lane.
7. Calculating the average traffic speed.
8. Calculating the average speed of the vehicles by their class:
 - a. passenger car;
 - b. truck shorter than 12 m;
 - c. truck longer than 12 m;
 - d. bus.

9. Determining the distance between the vehicles (up to 255 m).
10. Calculating the road load.
11. Registering some moving violations:
 - a. exceeding the speed limit;
 - b. driving along the wrong side of the road;
 - c. stopping violations;
 - d. invalid reversing;
 - e. driving forbidden types of vehicle.
12. Detecting traffic jams.

The following tools can be used to create the report by results of the **Traffic Detection** module working:

1. **Intellect Web Report System** module. This module is not included in the distributive of *Auto-Intellect* software and is installed separately (see [Web Report System](#) document).
2. **Traffic Monitor** object. Configuration of this object is described in the Traffic Monitor interface object setup section. Working with the dialog box is described in the [Operator's Guide](#) document).

5.2.20.2 Traffic Detection module licensing

The *Module RDC* - manufactured methods are used in the **Traffic Detection** program module. The *Module RDC* provides the USB license key which allows protecting of usability their method on the server (independent from the number of processed video channels).

USB-keys can be the following types:

1. Demo key - provides full-function working during 720 hours (it is measured summed time of working the method instead of time past the moment of receiving the key).
2. Permanent.

It is impossible to update remotely the demo key to the permanent or to add time to the demo key.

5.2.20.3 Video camera mounting and setup requirements for the Traffic Detection module

The following video camera requirements should be met in order to ensure the recognition of license plate numbers using the *Auto-Intellect* system.

№	Property	Range	Comment
1	Camera type	Analog color PAL camera, or analog monochrome CCIR camera	IP cameras with not less than 25 fps and 4 Mbit/s bitrate also can be used.
2	Camera resolution	Not less than 320x240	
3	Illuminance in the monitored area	Not less than 0.02 lux	
4	Signal/noise ration	50 dB or more	
5	Auto aperture and auto electronic shutter	1/1000	
6	Focal length	4-8 mm for 1/3" CCD Lens with adjusting focal length and auto aperture can be used.	

It is not recommended to use the frame resolution more than 352 x 288 (CIF) because it will result in large spend of resources and video will be compressed until 352 x 288 (CIF).

The video camera should be located at the top of the lamp pole at the edge of the road (side location), or at the horizontal truss above the road (central location).

If the camera meets the main requirements (see the [General requirements for mounting and configuring of cameras](#) section) and is aimed at the recommended directions, up to six lanes can be processed in case of a central camera location, and up to four lanes in case of a side location.

If recommendations for parameters, mounting and configuring video camera are fulfilled, the typical error of counting the following characteristics will be as follows:

- 5% - while determining number of vehicles;
- 10% - while determining average speed of moving;
- 10% - while determining average distance;
- 10% - while classifying vehicles.

Note.

Depending on conditions of monitoring and factors of video camera mounting/configuring, errors can differ from typical error.

Conditions of applicability of the **Traffic Detection** module are following:

- visibility of vehicle or vehicle headlight (at night) - not less than 50m;
- speed of vehicle - more than 20 km/h;
- statistical sampling - not less than 1000 vehicles.

When mounting the **Traffic Detection** cameras, follow these recommendations:

1. Mount the cameras at a height of 8 to 20 m.

Note.

Optimum camera height is 12 m.

2. Mount the cameras not farther than 3 m from the road edge.
3. Horizon is not to be in the camera visibility scope.

The camera operates properly if its viewing zone contains not less than 25 m of road length, and the road in the image is as close to vertical as possible. The figure shows the road image if the camera is mounted at the recommended location.



The following figure shows the maximum allowable deviation of the road image from the vertical line (30 degrees).

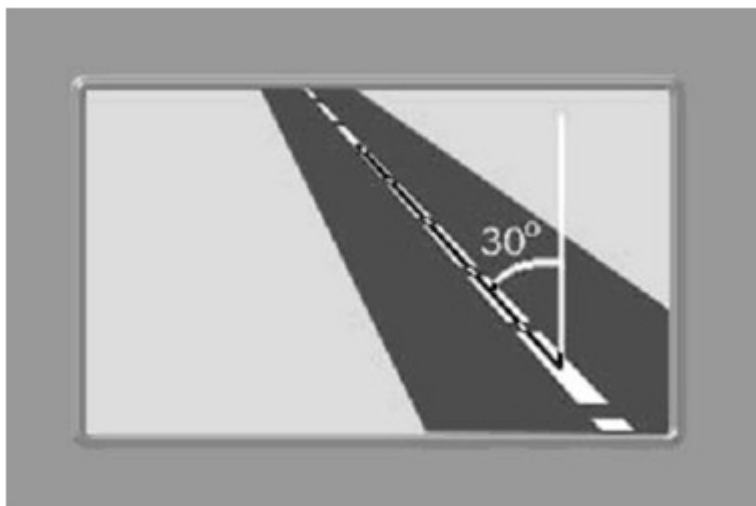

The camera mount should have two degrees of freedom, which allows it to adjust its orientation in the directions shown in the following figure.

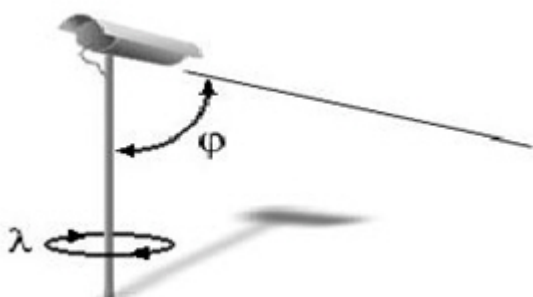

The camera can be tilted and rotated during its mounting and setup.

5.2.20.4 The Traffic Detection software module setup

The **Traffic Detection** software module is designed for detecting the overall characteristics of the traffic and the driving parameters of individual vehicles.

Note.

The **Traffic Detection** module operates correctly if the video signal is fed at a rate of 25 frames per second for each **Traffic Detection** object with no frame skipping. Video receiving is to be performed without missing of frames. If the video is received at a slower rate, the vehicle type and moving parameters may be determined with errors. Total CPU load for the whole system should not exceed 80%.

Attention!

Allowable error at determining the number of vehicles is 10% and allowable error at vehicles recognizing is 15%. Errors determination is performed while moving not less than 1000 vehicles in the camera field of view.

Attention!

Resolution of processed video stream is to be coincide with resolution of stream on which the **Traffic Detection** module was configured.

5.2.20.4.1 Traffic Detection setup procedure

To set up the **Traffic Detection** module, use the following procedure:

1. Select the camera to be used by the **Traffic Detection**.
2. Specify the time depth of the database archive.
3. Specify the time period for statistics update.
4. Set the road markings.
5. Import or export the road markings file.
6. Set the parameters for joint operation of the **Traffic Detection** and the **Speed traps server** modules.
7. Specify the criteria for detecting the traffic jam start.
8. Specify the criteria for detecting the traffic jam end.
9. Specify the names for traffic movement directions to be displayed in the **Traffic Monitor** window.
10. Select the events to be recorded to the database and to generate alarms when using the **Traffic Monitor** window.

The following sections describe the setup in more detail.

5.2.20.4.2 Selecting the camera to be used by the Traffic Detection

To select the camera to be used by **Traffic Detection**, do the following:

1. Go to the **Traffic Detection** object settings panel.

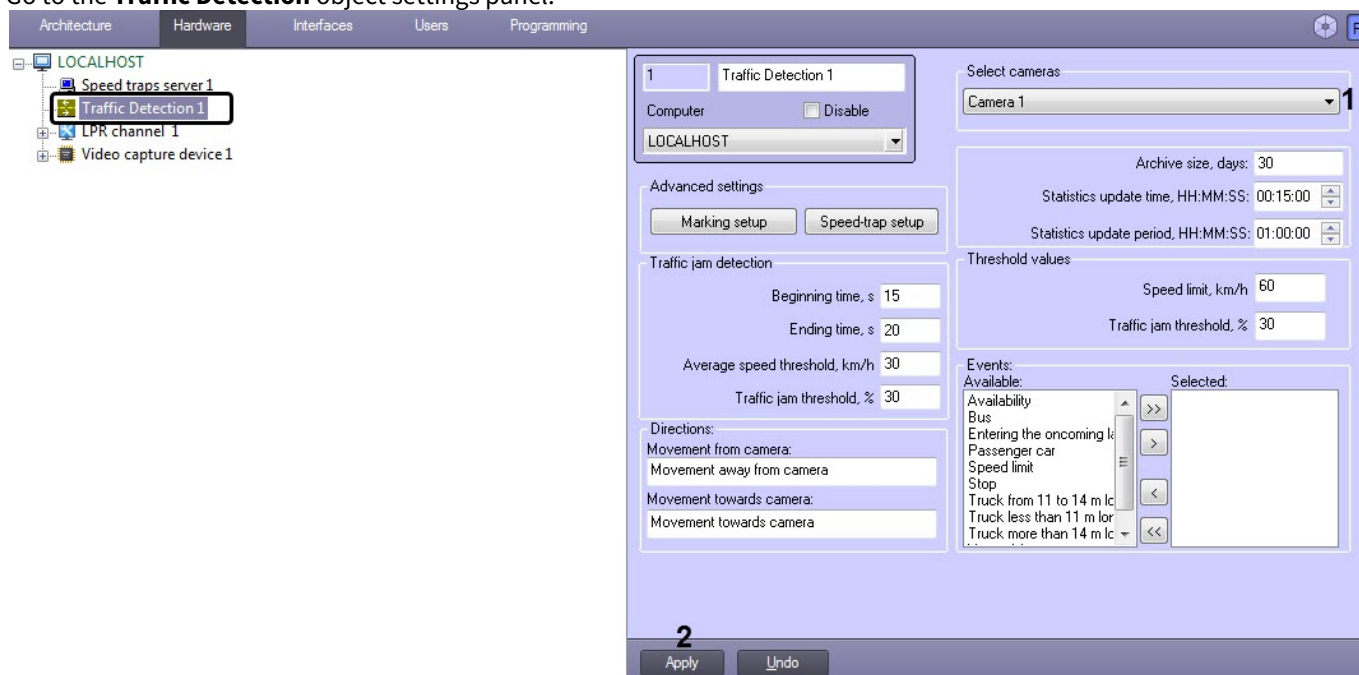

2. From the **Select cameras** drop-down list (1), select a camera aimed at the roadway, the video from which will be processed by the **Traffic Detection** module.

Note

Prior to that, the camera should be created and configured in *Intellect*.

3. Click **Apply** (2).

The camera to be used by the **Traffic Detection** is selected.

5.2.20.4.3 Setting up the database archive depth

All events that *Auto-Intellect* receives from **Traffic Detection** are saved in the SQL database. The database may soon become of considerable size which increases the CPU load. To limit the database size, the events storage period can be set up for the database. This is called the archive depth.

To set up the archive depth, do the following:

1. Go to the **Traffic Detection** object settings panel.



2. In the **Archive size, days** field (1), enter the number of days to store the events in the database.
3. Click **Apply** (2).

Archive depth is now set.

5.2.20.4.4 Setting up the update time and period for displaying statistics

Set the update time and period for displaying statistics as follows:

1. Go to the **Traffic Detection** object settings panel.



2. In the **Statistics update time, HH:MM:SS** field (1), specify the time period for updating the current data statistics.
3. In the **Statistics update period, HH:MM:SS** field (2), specify the time period for which the current data statistics will be displayed.
4. Click **Apply** (3).

Setting the update time and period for displaying statistics is complete.

5.2.20.4.5 Setting up the road markings parameters

The road markings setup should be specified: number and location of the driving lanes and traffic directions.

Note.

Only pre-installed road markings corresponding to the demo video file Demo.avi from the distribution package is always used while working in the demo mode, for example without the *RDC Module* electronic key (TMKernel). Detailed information about licensing the **Traffic Detection** module see in the [Traffic Detection module licensing](#) section.

To set up the markings parameters, do the following:

1. Go to the **Traffic Detection** object settings panel.

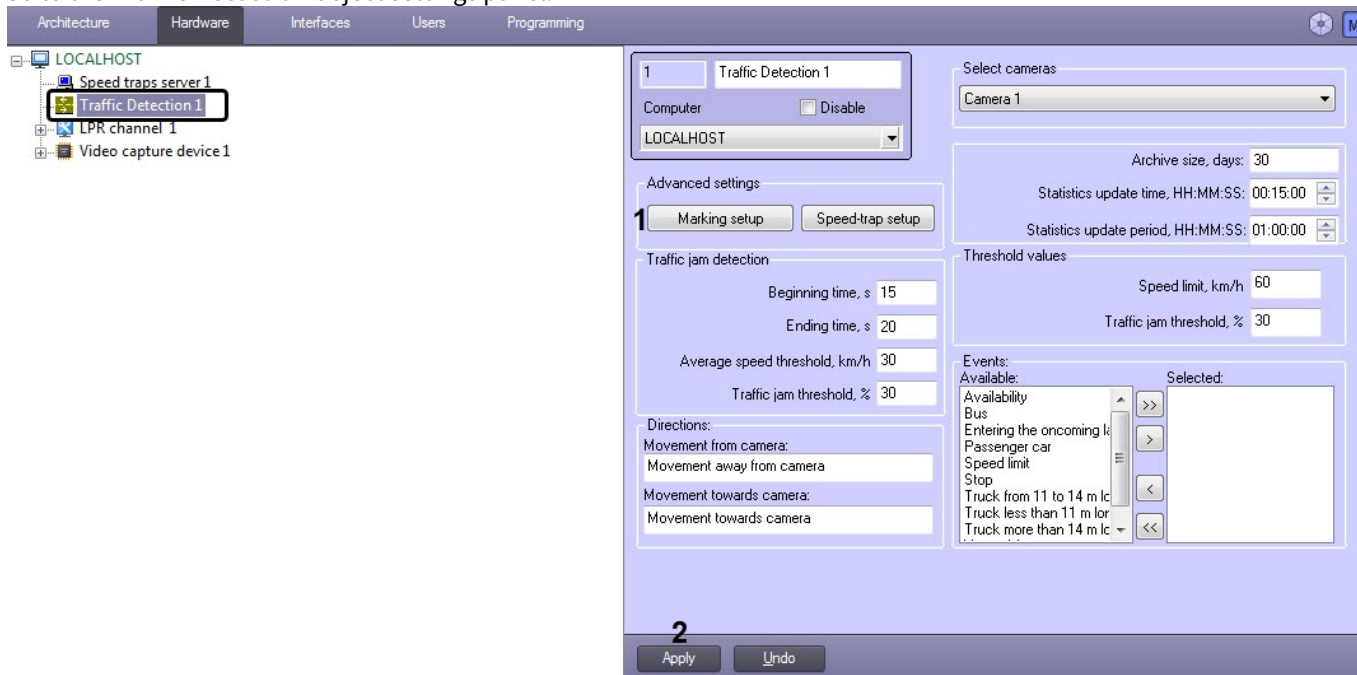

2. Click the **Marking setup** button and select the **Set marking** item from the menu (1).
3. After that, the **Advanced settings** window opens.
4. In the Advanced settings window, select the video frame to be used for markings setup. To select the frame, click the **Select frame** button at the appropriate moment.

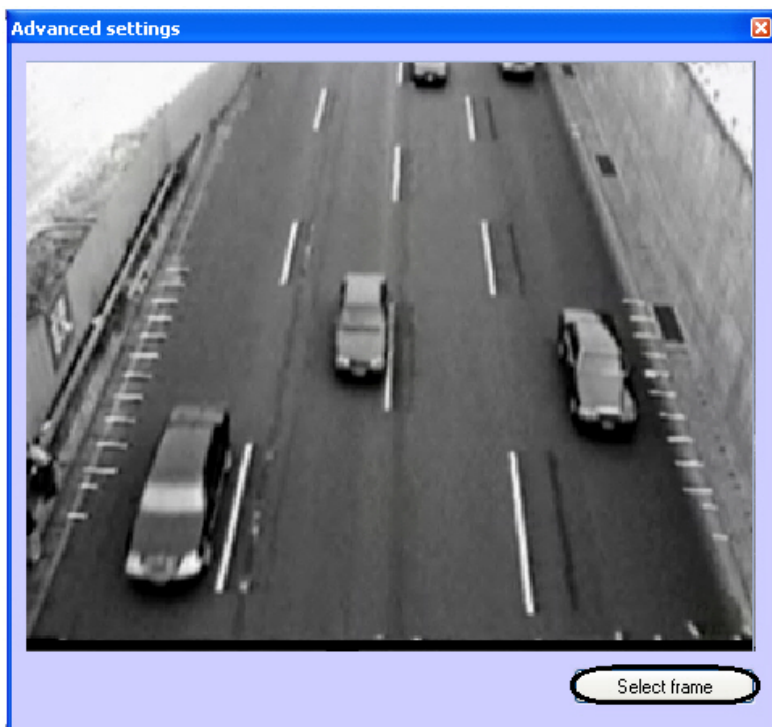

The **Advanced settings** window closes and the **Camera Calibration** window opens.

5. Set the switch into the **Specify camera parameters** position to set camera parameters or into the **Specify reference points** position to set the keypoints.

To set camera parameters, do the following:

- a. In the **Camera height (m)** field enter the height of the camera mounting in meters (**1**).
- b. In the **Focus (mm)** field enter the focal distance in millimeters (**2**).
- c. In the **Effective pixels** section enter the number of effective pixels in horizontal and vertical direction (**3**).
- d. In the **Pixel size (um)** enter the size of pixel in horizontal and vertical direction (**4**).

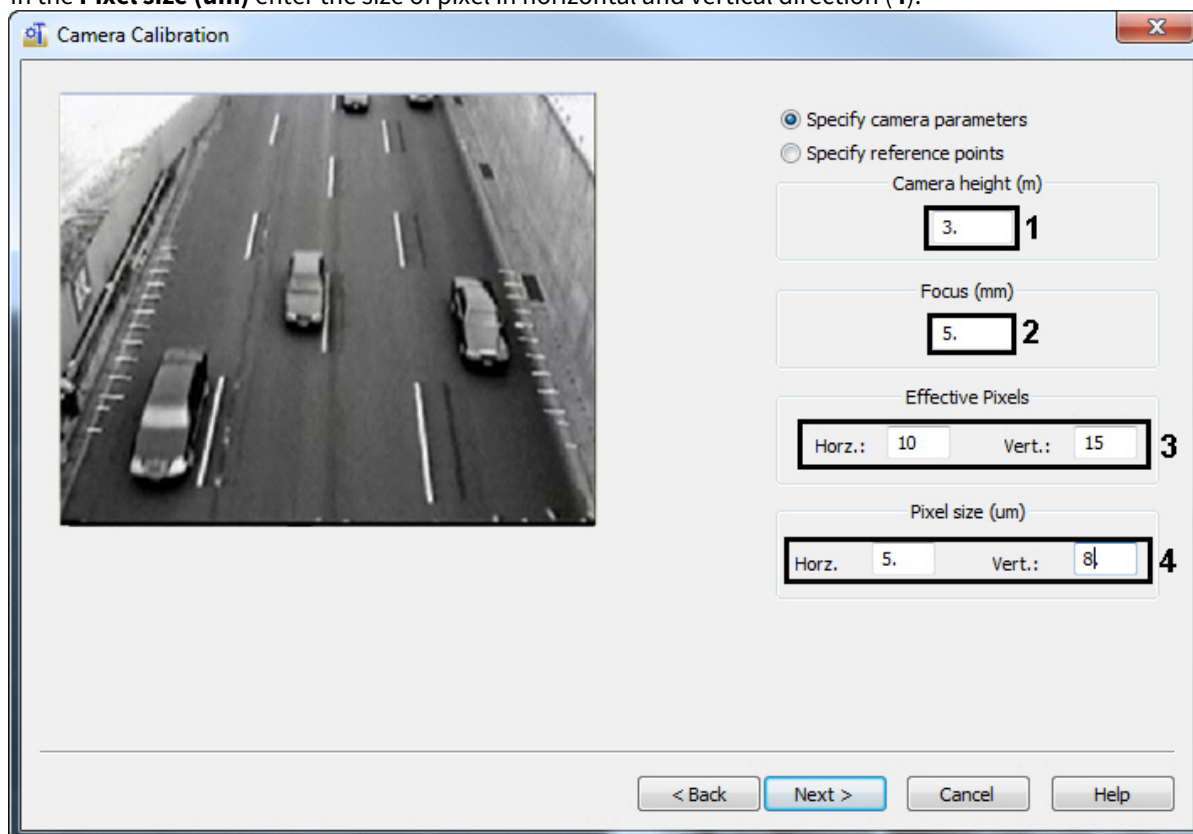

In case of switch is set into the **Specify reference points** position:

Note.

A keypoint is a small object or a marking easily identified in the image. The actual road markings can be used as key points. No more than two points should lie on a single straight line. The keypoints should be as far from each other as possible, although inside the camera viewing zone. The farther the keypoints are from each other, the more precise will be the setup. Measure and write down the coordinates of actual keypoints on the road relative to any origin. These will be the ground coordinates of the keypoints. A keypoint is a small object or a marking easily identified in the image. The actual road markings can be used as key points. No more than two points should lie on a single straight line. The keypoints should be as far from each other as possible, although inside the camera viewing zone. The farther the keypoints are from each other, the more precise will be the setup. Measure and write down the coordinates of actual keypoints on the road relative to any origin. These will be the ground coordinates of the keypoints.

Camera Calibration

Specify camera parameters
 Specify reference points

Reference point 1

Earth	0.00	Image	31
Earth	0.00	Image	170

Reference point 2

Earth	12.00	Image	292
Earth	0.00	Image	179

Reference point 3

Earth	12.00	Image	264
Earth	9.00	Image	102

Reference point 4

Earth	0.00	Image	63
Earth	9.00	Image	96

It is required to specify four keypoints and their coordinates. On default, keypoints are specified automatically. To change keypoints and their coordinates do the following:

- i. Remove from the screen the keypoint whose coordinates you want to change. This requires a point with the mouse and hold down the **Shift**, press the left mouse button.
- ii. Click the position for a keypoint in the video frame and press the left mouse button.

- iii. In the zoom window that opens, mark the keypoint and enter the ground coordinates in the X and Y fields.

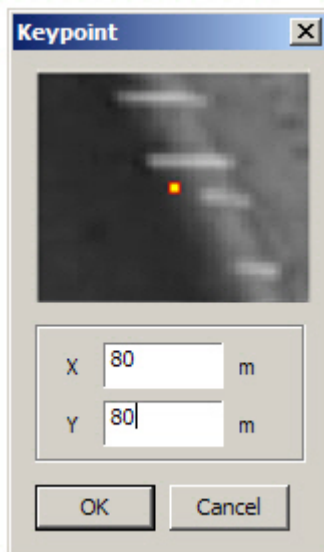

- iv. Click **OK**.

- 6. To go to the following step of setting press the **Next** button.
- 7. The **Working zone** window opens. This window allows setting the road edges, number of lanes and the driving directions.

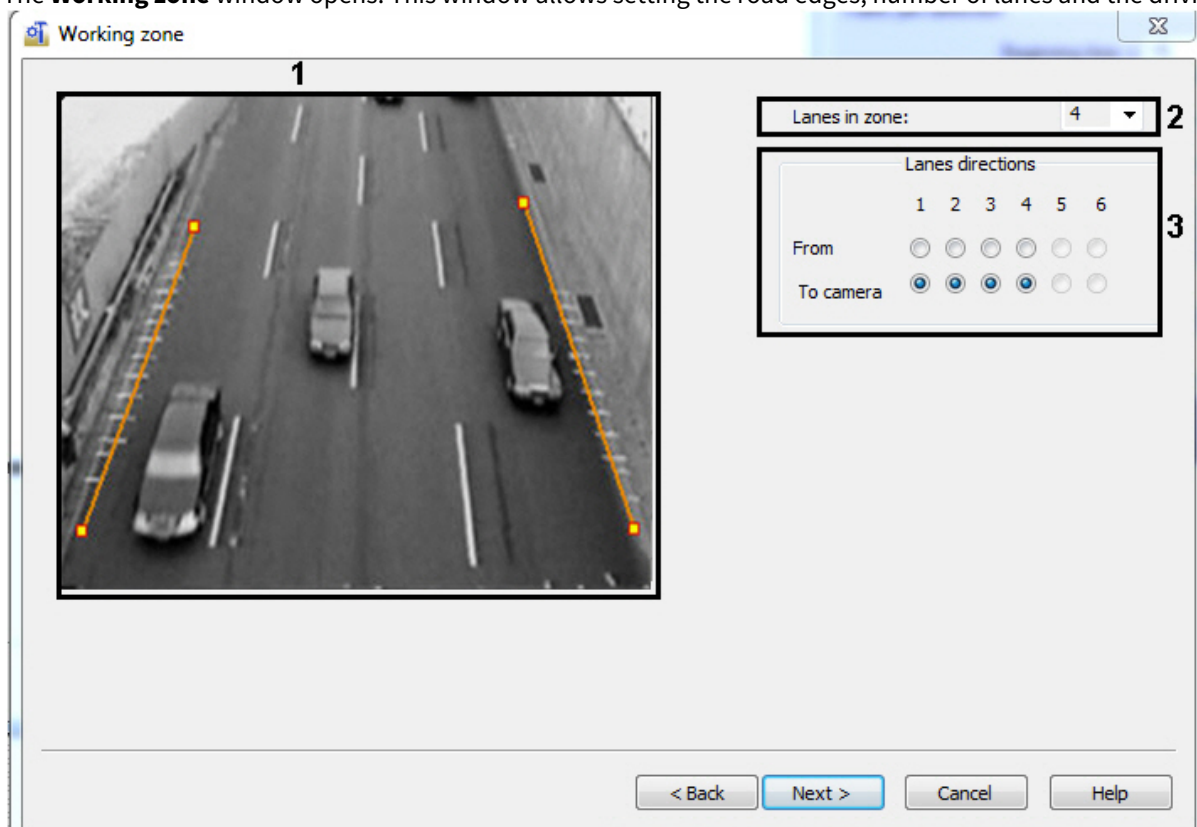

By default the road marking is set automatically.

To set the markings, do the following:

- a. To remove the road edge **Shift** click one of its endpoints by pressing the left mouse button (**1**).
- b. To set the road edge, click the road edge in the image, press the left mouse button, drag the cursor to another edge of the road in the video frame, release the button (**2**).
- c. Set the number of driving lanes (**3**).
- d. Set the driving direction for each lane (**4**).
To go to the following step of setting press the **Next** button.

8. The **Affixment result** window opens.

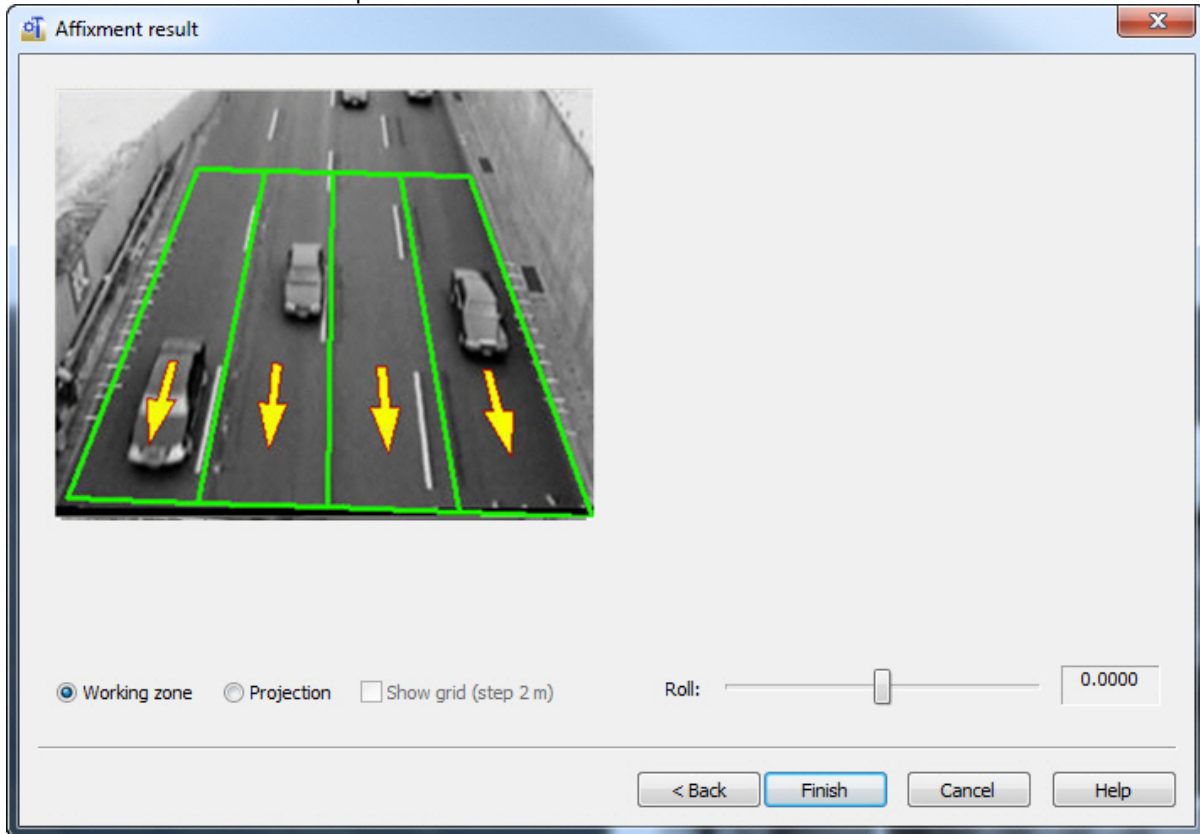

The image with the road markings is displayed as the result of the setup.

To change the width of lane mouse over the internal border of the road markings and expand it to the required size clicking the left mouse button.

- Set the **Projection** checkbox to view the projective image.

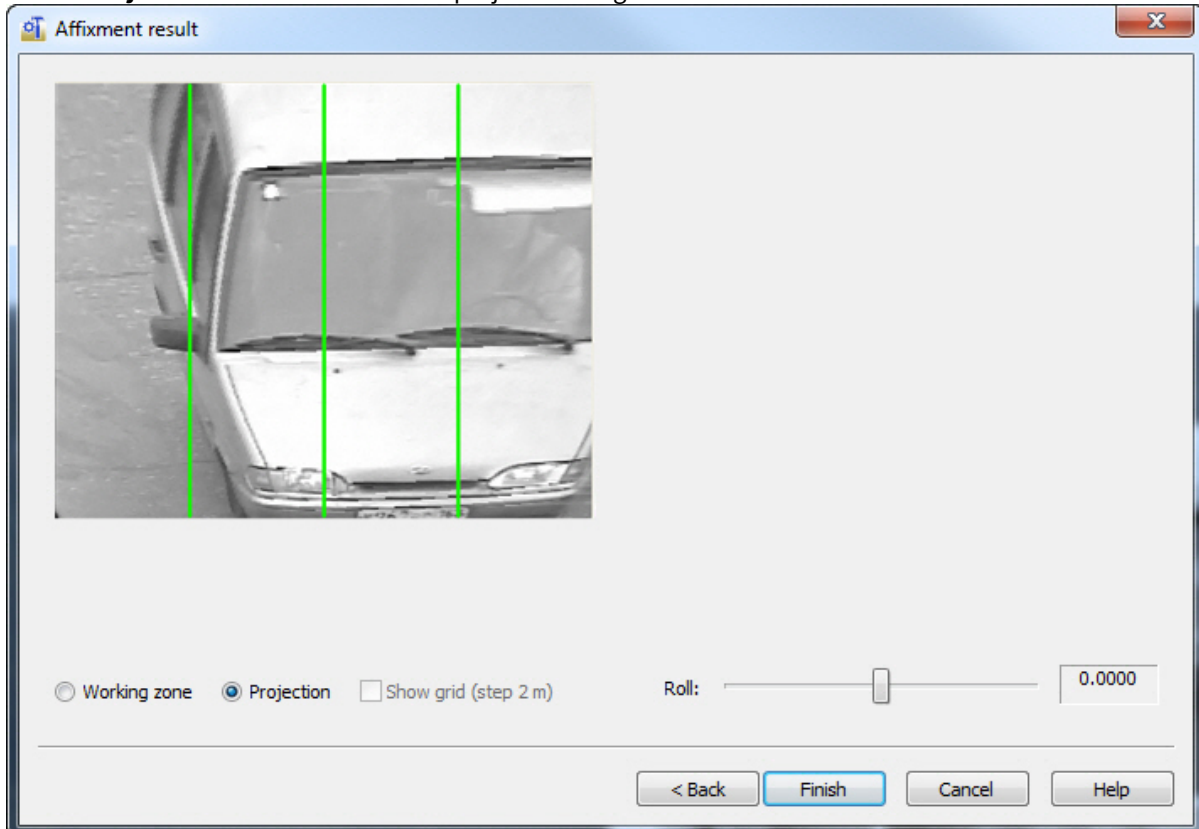

Click the **Finish** button to complete the setup.

- Click **Apply (2)**.

The road markings are now set.

5.2.20.4.6 Importing and exporting the file with the markings parameters

Traffic Detection allows importing and exporting the file that contains the parameters of the road markings.

To import and export the file, do the following:

1. Go to the **Traffic Detection** object settings panel.

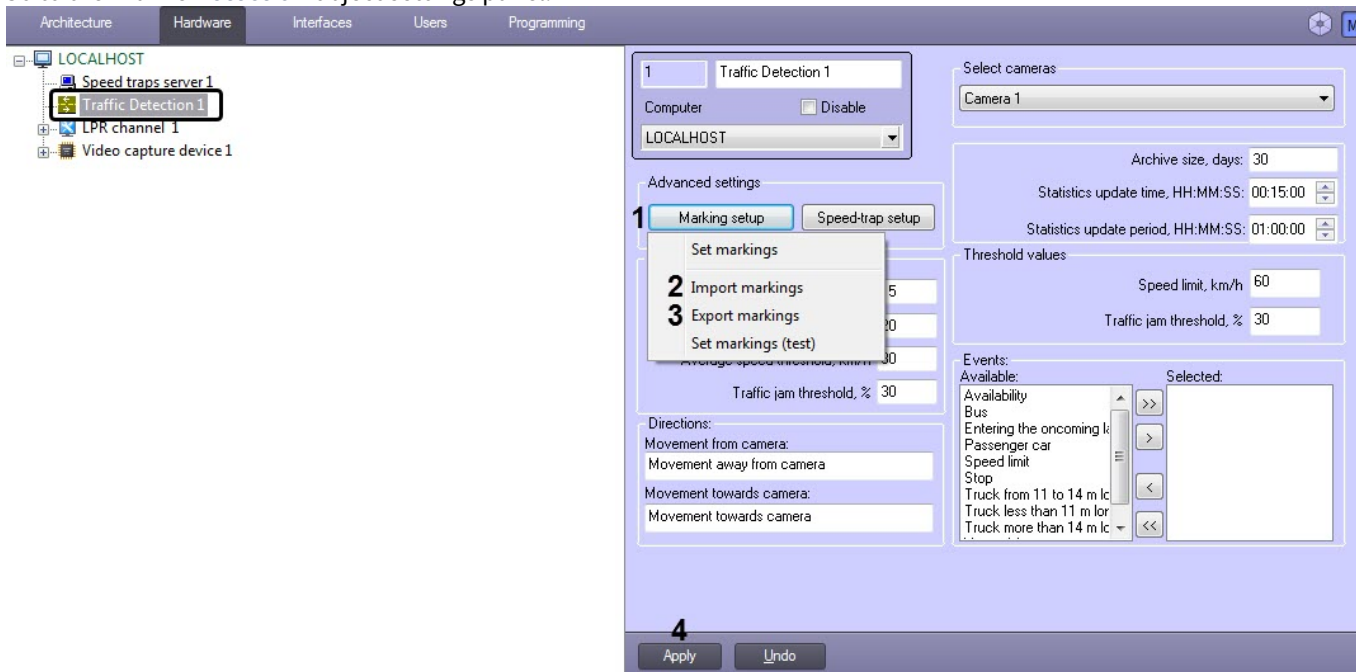

2. To import a file, click the **Marking setup** button (1) and select the **Import marking** item (2).
As a result, the standard file open window opens. In that window, select the markings file and click **Open**.

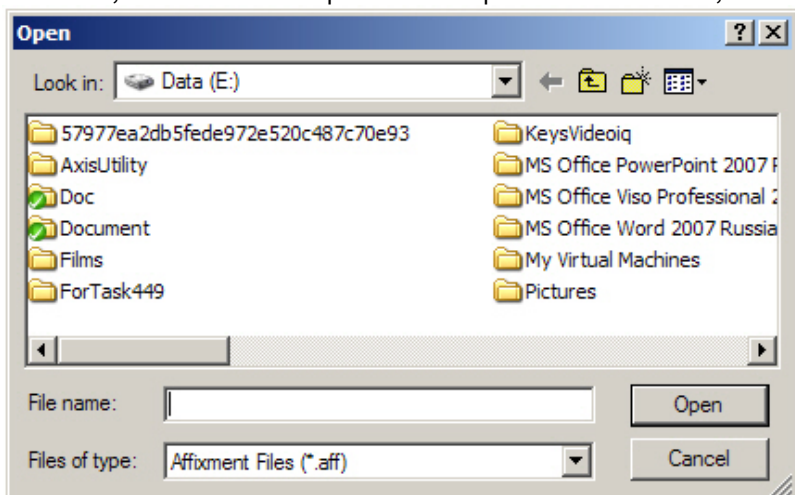

3. To export a file, click the **Marking setup** button (1) and select the **Markings export** item (3).

- As a result, the standard file saving window opens. In that window, select the folder, enter the file name to save the markings to and click **Save**.

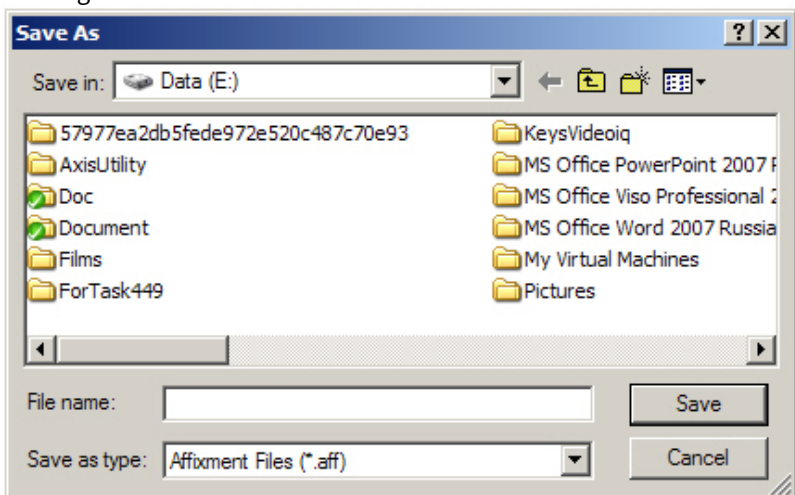

- Click **Apply (4)**.

The markings file is now imported or exported.

5.2.20.4.7 Setting up the joint operation of Traffic Detection and Speed traps server modules

The *Auto-Intellect* software package allows the **Traffic Detection** and **Speed traps server** modules to operate together.

Note.

By default, the vehicle speed is recognized based on the video image received from the camera, linked to the **Traffic Detection** module. When the **Speed traps server** module is connected to the **Traffic Detection**, the speed-trap represented by the **Speed traps server** module determines the speed of the vehicles moving along the corresponding lane.

During the joint operation, each vehicle recognized by the **Traffic Detection** module is compared to the speed value set specified for the Speed-trap device.

To set up joint operation of **Traffic Detection** and **Speed traps server**, do the following:

- Go to the **Traffic Detection** object settings panel.

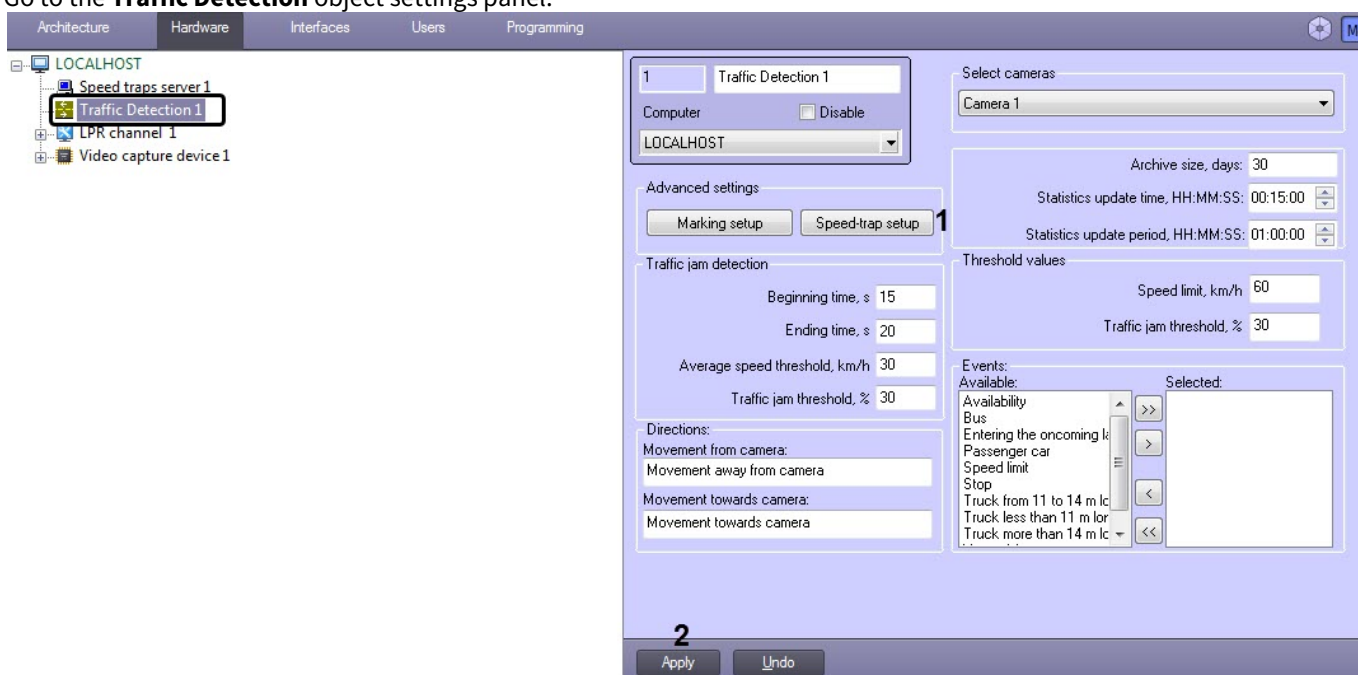

- Click the **Speed-trap setup** button (1) to open the setup menu for the joint operation of **Traffic Detection** and **Speed traps server**.

The **Speed-traps by lane** window will open.

In the **Speed-traps by lane** window, the synchronization parameters should be set for the lanes with the speed-traps. Do the following:

- In the **Speed-trap server** drop-down list, select the **Speed-trap server** object representing the speed-trap device directed at the corresponding lane (1).
- In the **Max. vehicle timeout (sec)** field enter the number of milliseconds that it takes the vehicle to move from the speed detection area to the loop detector of the **Traffic Detection** module.

Note.

This parameter is designed to synchronize the operation of the **Speed traps server** and **Traffic Detection** modules.

Click **OK**.

- Click **Apply** (2).

The **Speed traps server** and **Traffic Detection** modules are now set for joint operation.

5.2.20.4.8 Setting up the jam detection parameters

The **Traffic Detection** module is able to detect the emergence of traffic jams on the road. The module generates a specific event and, in certain cases, notifies the operator.

Notes

- A jam is detected if the average traffic speed is lower than a certain value and the overall road load is higher than a certain value for a specified time period.
- The traffic jam event is considered to end when the average traffic speed is higher than a certain value, and the overall road load is lower than a certain value for a certain period of time.

To set up the jam detection parameters, do the following:

1. Go to the **Traffic Detection** object settings panel.

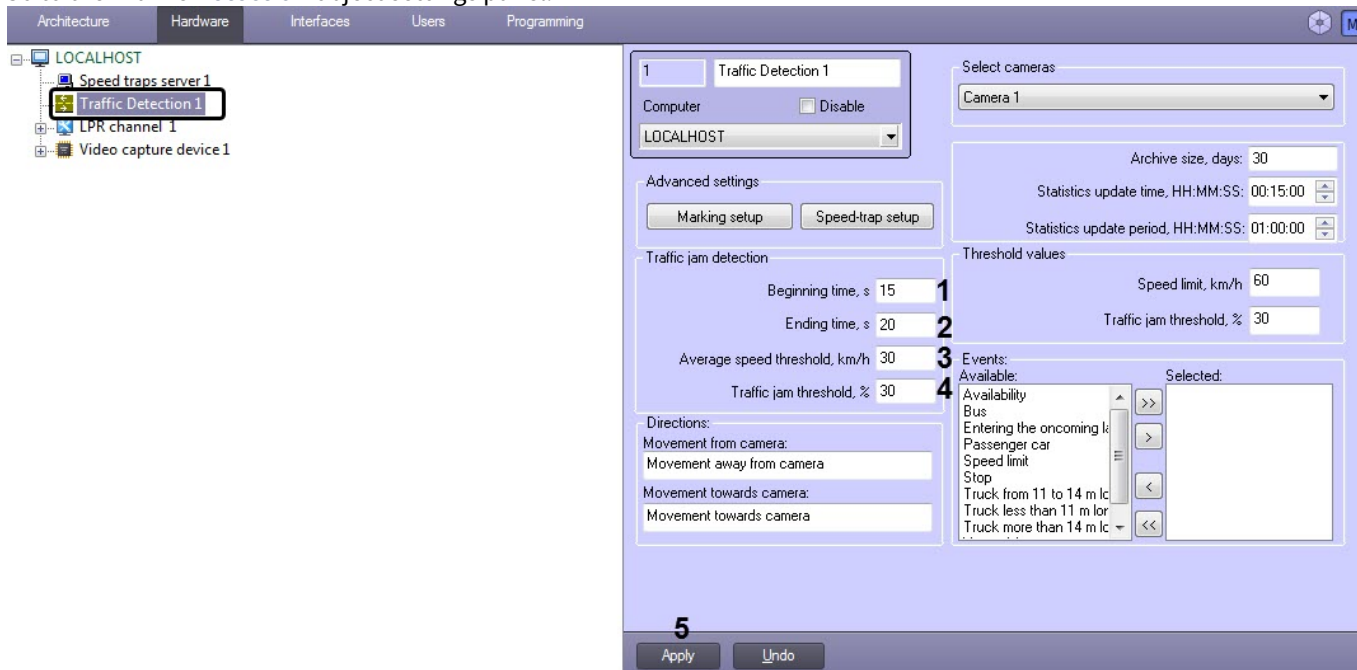

2. In the **Beginning time, s** field (1), enter for how long (in seconds) the jam conditions must be satisfied for the start of the jam to be detected.
3. In the **Ending time, s** field (2), enter for how long (in seconds) the reverse jam conditions must be satisfied for the end of the jam to be detected.
4. In the **Average speed threshold, km/h** field (3), enter the average traffic speed:
 - If the average traffic speed is lower than this value, then a traffic jam may be detected (if other conditions are satisfied).
 - If the average traffic speed is higher than this value, then a traffic jam may be considered to have ended (if other conditions are satisfied)
5. In the **Traffic jam threshold, %** field (4), enter the road load (in percent):
 - If the road load is higher than this value, then a traffic jam may be detected (if other conditions are satisfied).
 - If the road load is lower than this value, then a traffic jam may be considered to have ended (if other conditions are satisfied).

Note.

The road load parameter is calculated using the following formula:

$$\text{Road_load} = \frac{T_0}{T} * 100\%$$

where T_0 is the time during which the vehicles were in the coverage area of the **Traffic**

Detection software module for the statistics update period, and T is the total operating time of the **Traffic Detection** software module for the statistics update period (see [Setting up the update time and period for displaying statistics](#)).

6. Click **Apply** (5).

The jam detection parameters are now set.

5.2.20.4.9 Setting the driving direction names to be shown in the Traffic Monitor window

The **Traffic Detection** software module is represented by the **Traffic Monitor** interface window (see the [The Traffic Monitor interface object setup](#) section). The **Traffic Monitor** window can be set up to display traffic driving parameters in the video image. The names for the traffic moving directions to be displayed can be specified during the module setup.

To set the direction names, do the following:

1. Go to the **Traffic Detection** object settings panel.

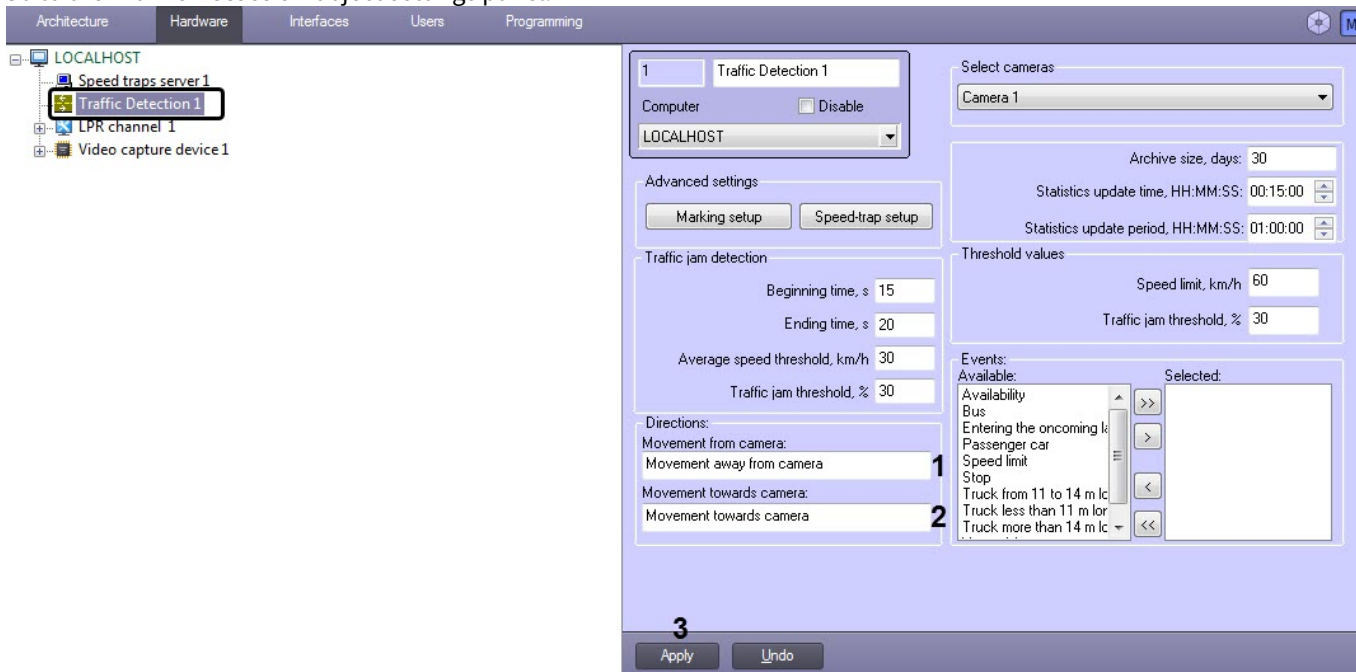

2. In the **Movement from camera** field (1), enter the name of the direction to be shown in the **Traffic Monitor** window for the vehicles moving away from the camera.
3. In the **Movement towards camera** field (2), enter the name of the direction to be shown in the **Traffic Monitor** window for the vehicles moving toward the camera.
4. Click **Apply** (3).

The traffic directions are now set.

5.2.20.4.10 Setting up the traffic limiting parameters

Certain limitations can be specified for the traffic during the **Traffic Detection** setup, i.e. the speed limit for individual vehicles and the maximum overall road load.

If any of these values exceeds the limit, it is highlighted in red color in the **Traffic Monitor** (see [Using the Traffic Monitor interface object](#)), and the alarm notification window can be set to open.

To specify the traffic limits, do the following:

1. Go to the **Traffic Detection** object settings panel.

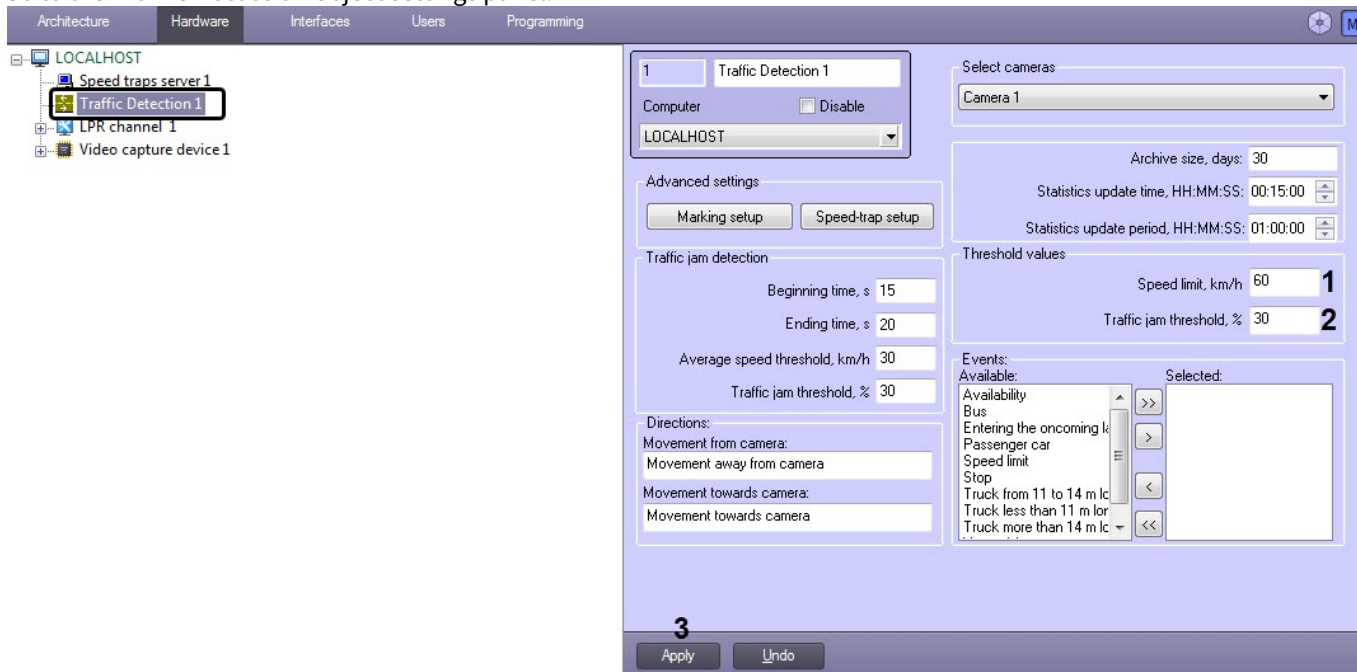

2. In the **Speed limit, km/h** field (1), enter the maximum allowed driving speed.
3. In the **Traffic jam threshold, %** field (2), enter the maximum allowed road load.

Note.

The road load parameter is calculated using the following formula:

$$Road_load = \frac{T_0}{T} * 100\%$$

where T_0 is the time during which the vehicles were in the coverage area of the **Traffic Detection** software module for the statistics update period, and T is the total operating time of the **Traffic Detection** software module for the statistics update period (see [Setting up the update time and period for displaying statistics](#)).

4. Click **Apply** (3).

The traffic limitations are now set.

5.2.20.4.11 Selecting the events to be saved to database and to generate notifications in the Traffic Monitor window

The **Traffic Detection** setup allows selecting the events generated by *Auto-Intellect* for this recognition module to be saved into its database (dt.mdb).

Note.

The selected events will be used to notify the operator in the **Alarm window** (see [The Traffic Monitor setup procedure](#) section).

To select the events to be generated, do the following:

1. Go to the **Traffic Detection** object settings panel.

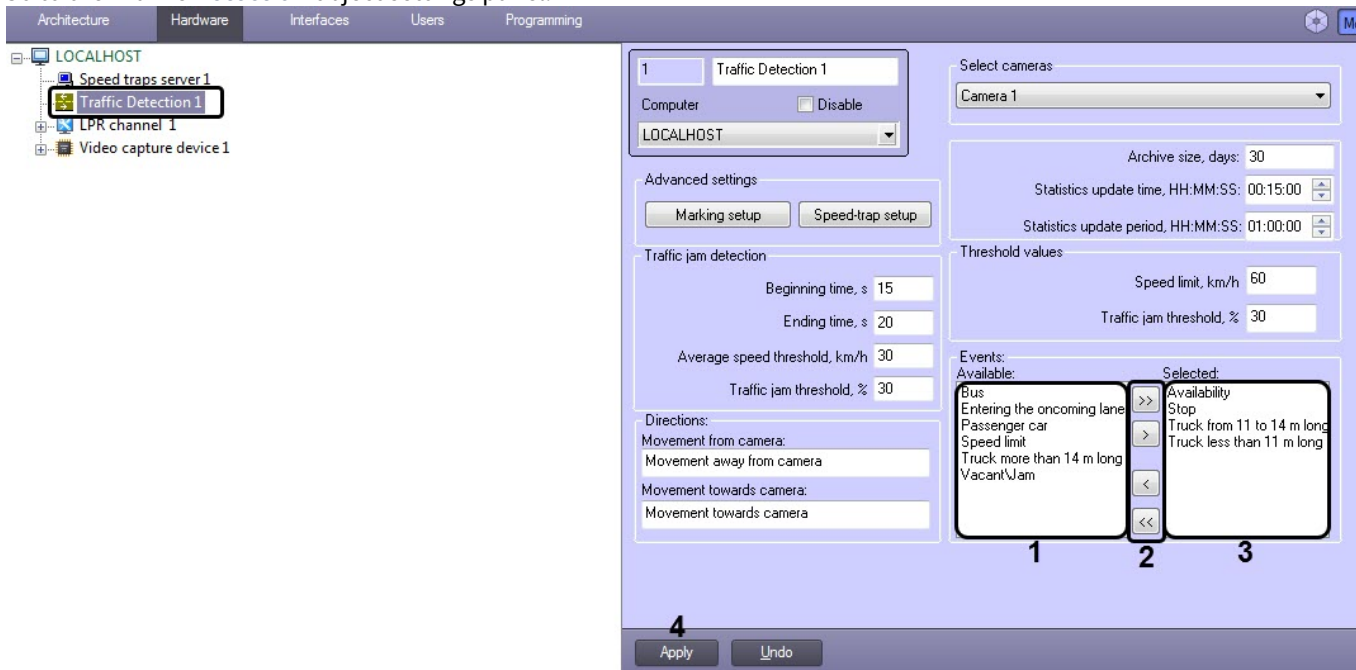

2. In the **Available** events list, select the events to be generated by the system (1).
3. Manage the event lists using the (2) buttons as follows:
 - a. To move the event to the selected events list, click the **right arrow** button.
 - b. To move all events to the selected events list, click the **right double arrow** button.
 - c. To remove the event from the selected events list, click the **left arrow** button.
 - d. To remove all events from the selected events list, click the **left double arrow** button.
4. As a result, the events to be generated by the system will be displayed in the **Selected** events list (3).
5. Click **Apply** (4).

The events to be generated and used for notification are now selected.

5.2.21 Camera of recognition upon request

5.2.21.1 Setting up the Camera of recognition upon request module

The LPR channel enables license plate recognition upon request using the **Camera of recognition upon request** object. This object allows you to configure the camera so that it captures and sends a video image to the recognition module after a specific trigger activates. It can be, for example, a macro, a script, or some event.

Note
For now this functionality is implemented for **CARMEN-Auto**, **VIT**, **RoadAR**, **ARH-Railway** and **ARH-Carriages** recognition modules only.

Note
When using the **Camera of recognition upon request** object along with the **VIT** recognition module, it is recommended to disable **VodiCTL_VPW_DYNAMIC_ENABLE** in the SDK tweaking, i.e. set the **False** value of this parameter, in order to prevent repeated recognition (see [The VIT module object settings panel](#)).

Configure the recognition upon request as follows:

1. Go to the **Camera of recognition upon request** settings panel created on the basis of the **LPR channel** object.

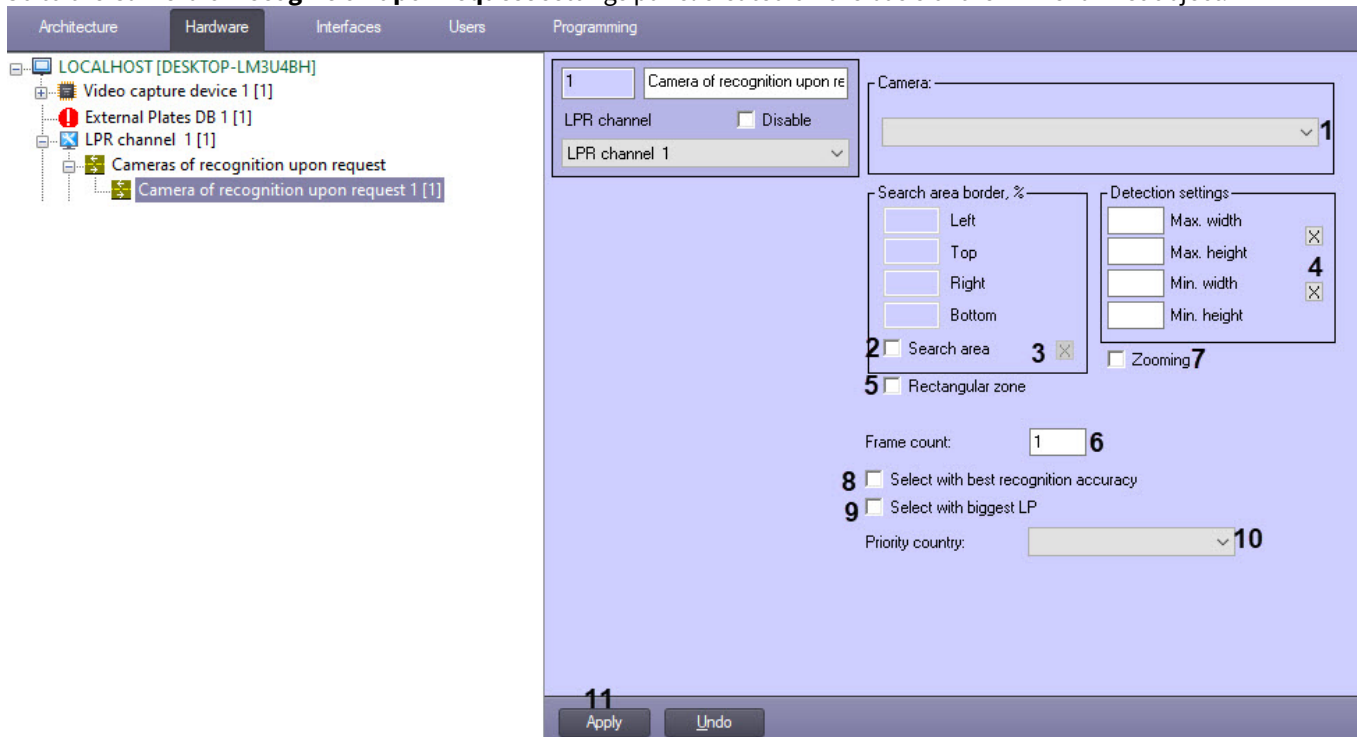

2. From the **Camera** drop-down list (1), select the camera that will work upon request.

Note

- The same camera can be selected in several **Camera of recognition upon request** objects.
- If the camera has been selected on the settings panel of the **Camera of recognition upon request** object, then it will become impossible to select any camera on the settings panel of the **LPR channel** object (see [Selecting the video cameras to work with the LPR channel](#)).

3. Set the **Search area** (2) checkbox in order to enable setting the search area border of the license plate in the frame.
 - a. In the **Left**, **Top**, **Right** and **Bottom** fields, set manually or using the button (3), by clicking which, the interactive interface of setting search area borders of the license plate appears—a video image from the corresponding video camera. You can set an arbitrary search area using the segments. To select a rectangular search area, set the **Rectangular zone** checkbox (5).

Note

The values in the **Left**, **Top**, **Right** and **Bottom** fields are specified in percentage to the surveillance window.

4. Set the maximum and minimum size of license plates in **Detection settings**:
 - a. Set the **Max.width** and **Max.height** parameters manually or using the button (4), by clicking which, the interactive interface of setting the zone parameters appears—a video image from the corresponding video camera.



- b. When required, click the **Stop video** button, select the required area using the left mouse button and then click **OK**.

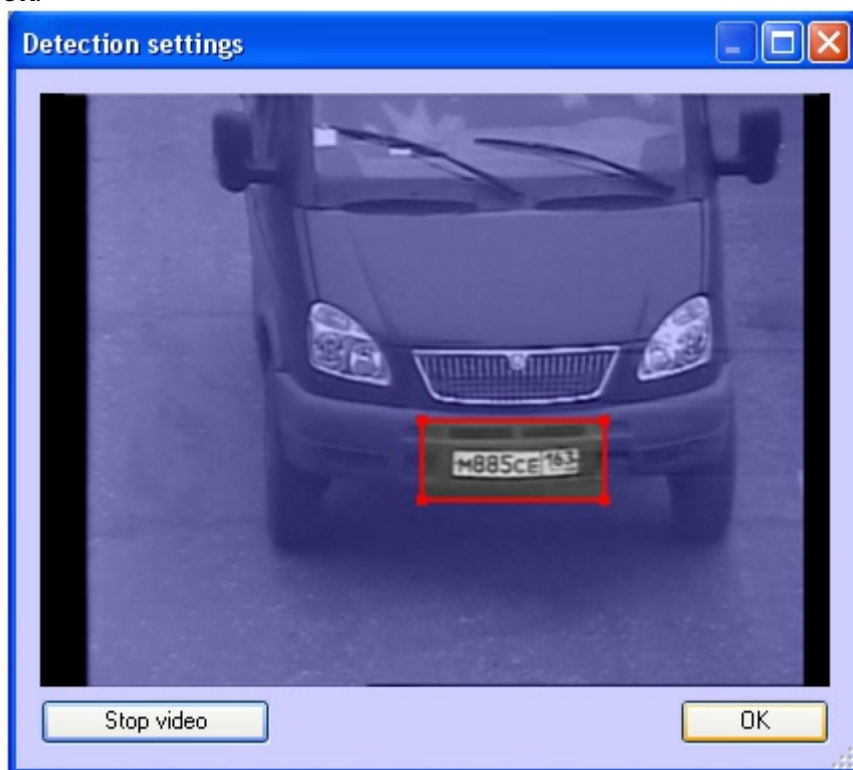

Results of setting zone parameters will automatically appear in the **Max.width** and **Max.height** fields. Set the **Min.width** and **Min.height** parameters the same way as **Max.width** and **Max.height**.

5. For the **Frame count (6)** parameter set the number of frames that will be analyzed when recognizing the license plate.

Note

It is recommended to set the number of frames to no more than **1**.

- Set the **Zooming (7)** checkbox in order to speed up the license plate recognition for megapixel cameras without any quality loss. The request, which will trigger the camera, can be configured in two ways:

Note

This checkbox is relevant only when the width of the **Search area** is more than 150 pixels. The recognition speed increases:

- 2 times if the value of the **Width** parameter is more than 150 pixels;
- 4 times if the value of the **Width** parameter is more than 400 pixels;
- 8 times if the value of the **Width** parameter is more than 800 pixels.

- Set the **Select with best recognition accuracy** checkbox (8) to show the recognition results with the highest accuracy rate, as the bigger LP size does not always result in a better recognition accuracy.
- Set the **Select with biggest LP** checkbox (9) to show the results with the biggest LP sizes.
- From the **Priority country** drop-down list (10) select the country which LPs should be shown first.
- Click the **Apply** button (11).

The request, which will trigger the camera, can be configured in two ways:

- Using a macro.** To do this, switch to the **Programming** tab in *Intellect* and select the **Macros** item in the programming tools tree. A window for creating a macro will open, enabling you to create an event of any complexity that will trigger the recognition upon request. An example of the simplest macro for recognition upon request is shown in the figure below. For details on working with macros, see [Creating macros](#).

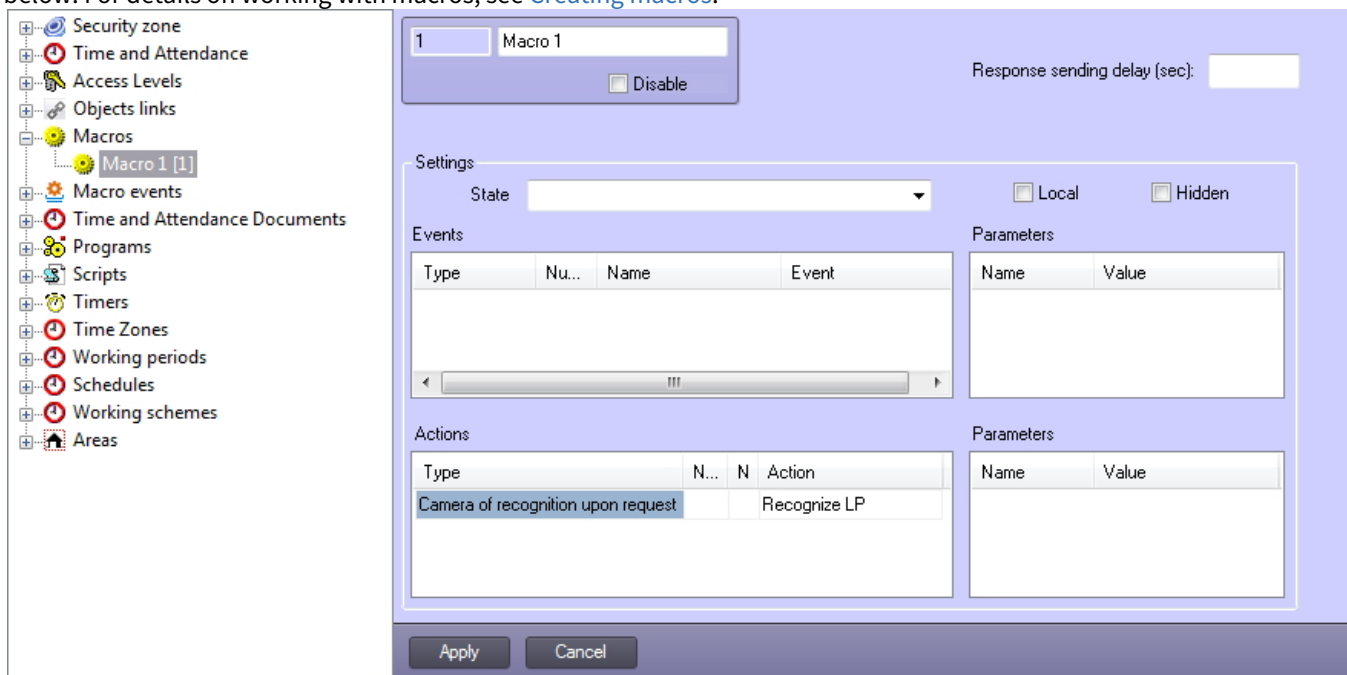

- Using a script or the IIDK interface.** To do this, go to the **Programming** tab in *Intellect* and select the **Scripts** item in the programming tools tree. A window for creating a script will open, enabling you to create an event of any complexity that will trigger the recognition upon request. For details on working with scripts, see [Creating a script](#). An example of a simple script for working with a camera for recognition upon request is shown below.

```
QUERY_CAMERA | ID | RECOGNIZE
```

where ID is ID of the camera in the *Intellect* objects tree.

For details on the IIDK interface, see [Intellect Integration Developer Kit \(IIDK\)](#).

License plate recognition upon request is now configured.

5.2.22 Vehicle Type Recognition module

5.2.22.1 The Vehicle Type Recognition Module functionality

The **Vehicle type recognition module** software module is designed to do the following:

1. Determine one of the following 6 vehicle types:
 - Undefined;
 - Bus;
 - Car;
 - Motorcycle;
 - Small bus;
 - Truck.
2. Record the events about determining the vehicle type in the database.

Note

It is possible to interact with the **Vehicle type recognition module** software module via HTTP requests (see [UrlServer](#)).

Attention!

To ensure the **Vehicle Type Recognition Module** operation, it is necessary to install the *Detector Pack subsystem* (see [Detector Pack. User Guide](#)). It is also necessary to configure any software module for license plate recognition (see [Activating the software module used for identifying the plates](#)) except the **Remote recognition** module, as it does not operate in conjunction with the **Vehicle Type Recognition Module** (see [Remote recognition](#)).

5.2.22.2 Video camera mounting and setup requirements for the Vehicle Type Recognition Module

The video camera requirements for the **Vehicle Type Recognition Module** operation are shown in the following table.

Camera specifications:	<ul style="list-style-type: none"> • It is recommended to use color cameras. When using black and white cameras, the detection quality can be noticeably worse. • Video resolution should be at least 640x480.
Images of objects:	<ul style="list-style-type: none"> • Vehicle area should be at least 10% of the frame area.

5.2.22.3 Setting up the Vehicle type recognition module

To configure the **Vehicle type recognition module**, do the following:

1. Go to the **Vehicle type recognition module** object settings panel, which is created on the basis of the **LPR channel** object.

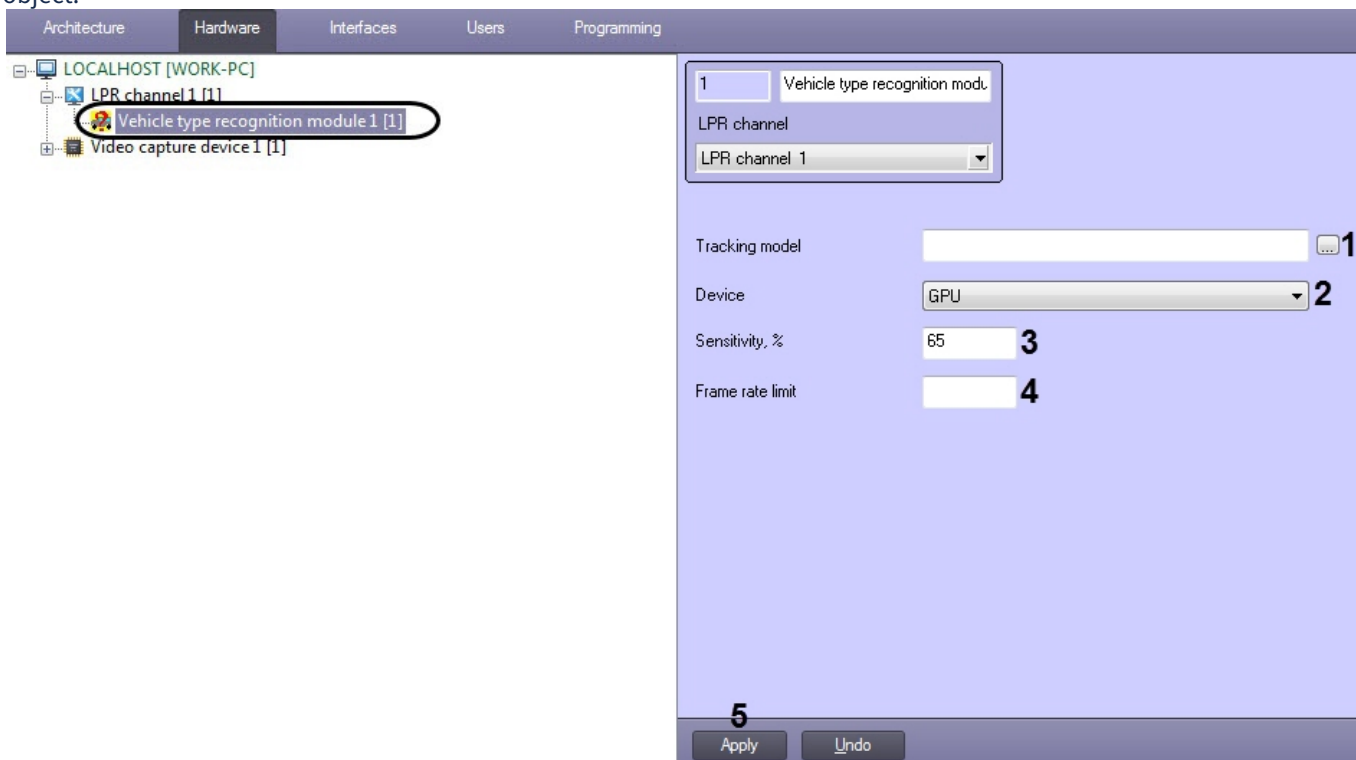

2. Click the  button (1) and open the trained neural network file in the standard Windows box that opens.
3. From the **Device** drop-down list (2), select the device on which this software module will operate:
 - **CPU** - Central Processing Unit from Intel (not recommended).
 - **GPU** - NVIDIA GPU.
4. In the **Sensitivity, %** field (3) specify the module sensitivity - an integer value in the range from **0** to **100**.

Note

The sensitivity is determined experimentally. The lower the sensitivity, the greater the likelihood of a false vehicle type recognition. The higher the sensitivity, the less likely the false vehicle type recognition, but some useful tracks may be skipped.

5. In the **Frame rate limit** field (4), enter the number of frames that will be sent for analysis. Frame decimation is performed at an interval, which is defined as: **Initial number of frames/Frame rate limitation**. If the field is empty, then all frames will be sent for analysis; if the value **0** is specified, then no frames will be sent.
6. Click **Apply** (5).

Note

It is possible to change the number of frames that are stored in the buffer for the Vehicle Type Recognition Module (UrlServer). To do this, change the value of the **UrlServerFrameBuffer** parameter (for details, see [Registry keys reference guide](#), for more information about working with the registry, see [Working with Windows OS registry](#)).

Configuring the **Vehicle type recognition module** software module is completed.

5.2.22.4 Saving the frames processed by the Vehicle Type Recognition module

-  [Registry keys reference guide](#), for details about working with the registry, see [Working with Windows OS registry](#).

Saving the frames processed by the **Vehicle Type Recognition** module may be necessary for training the neural network or for debugging the module (see [UrlServer debug window](#)).

To enable saving the frames processed by the **Vehicle Type Recognition** module (UrlServer), namely a cropped frame that shows only a vehicle, it is necessary to specify the path to the folder in which these frames will be saved in the **SavePictures** registry key.

If the frame is not cropped correctly (the vehicle is cropped or there are foreign objects present in the frame), it is necessary to empirically determine the right cropping parameters as follows:

1. For the **DeferLeft** registry key, specify the coefficient by which the number plate width will be multiplied. The photo will be cropped from the left relative to the number plate at a distance equal to the product (**DeferLeft * w**).
2. For the **DeferRight** registry key, specify the coefficient by which the number plate width will be multiplied. The photo will be cropped from the right of the number plate at a distance equal to the product (**DeferRight * w**).
3. For the **DeferUp** registry key, specify the coefficient by which the number plate height will be multiplied. The photo will be cropped from the top relative to the number plate at a distance equal to the product (**DeferUp * h**).
4. For the **DeferDown** registry key, specify the coefficient by which the number plate height will be multiplied. The photo will be cropped from the bottom relative to the number plate at a distance equal to the product (**DeferDown * h**).

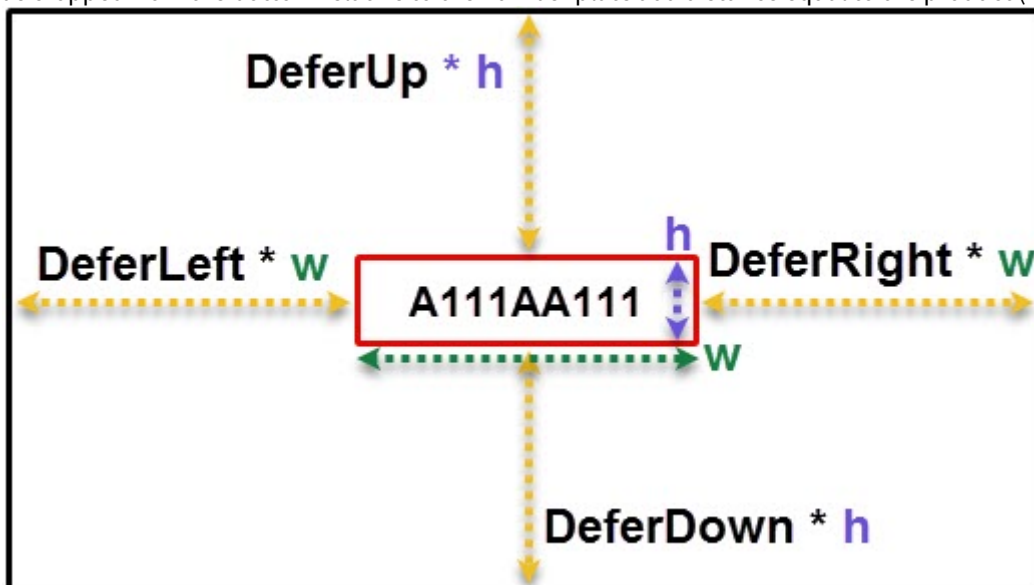

5.2.23 RoadAR vendor and model recognizer

5.2.23.1 The functionality of RoadAR vendor and model recognizer module

The **RoadAR vendor and model recognizer** module supports the following functionality:

- recognition of the vehicle manufacturer;
- recognition of the vehicle model;
- recognition of the type of vehicle (car, truck, bus, light commercial vehicle, unknown);
- recognition of the vehicle color;
- recording the recognized characteristics into the database and displaying the corresponding information in the **Online monitor** window.

Note

One of the software modules for license plate recognition should also be used for the **RoadAR vendor and model recognizer** module operation (see [Activating the software module used for identifying the plates](#)).

5.2.23.2 Licensing of the RoadAR vendor and model recognizer module

The **RoadAR vendor and model recognizer** software module is licensed for each object of this module.

5.2.23.3 Video camera mounting and setup requirements for the RoadAR vendor and model recognizer module

To ensure the recognition of the vehicle characteristics using the **RoadAR vendor and model recognizer** software module, it is necessary to install and configure the video cameras in such a way that the following requirements are met:

Camera specifications	<ul style="list-style-type: none"> • Recognition of the vehicle manufacturer and model: color or black and white image • Recognition of the vehicle color: color image
Video image	<ul style="list-style-type: none"> • The vehicle must be completely in the frame • The width of the vehicle in the frame is at least 100px
Lighting	<ul style="list-style-type: none"> • Recognition of the vehicle color: good lighting conditions

5.2.23.4 Configuring the RoadAR vendor and model recognizer module

In order for the **RoadAR vendor and model recognizer** module to operate, it is necessary to create the **RoadAR vendor and model recognizer** object based on the **LPR channel** object.

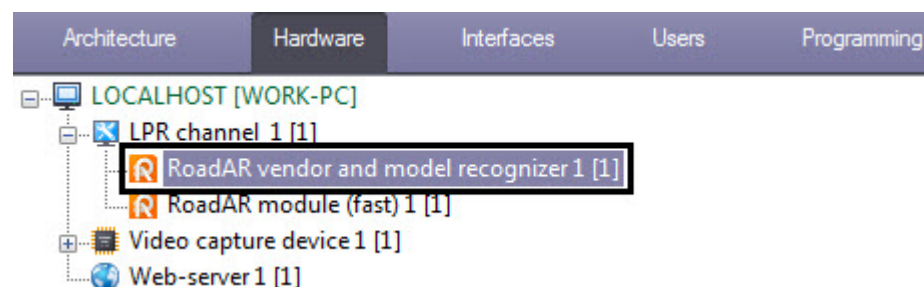

Note

If several *Roadar* recognition channels are created, the load on the CPU cores may be uneven, because the even distribution mode isn't enabled by default. To enable it, set the **1** value for the string parameter of the **IsProcessObject** registry key (see [Vertical solutions](#)).

5.2.24 Information-gathering subsystem

5.2.24.1 The Information-gathering subsystem functionality

On the page:

- [The IntelliVision vehicle detection functionality](#)
- [The Vehicle Processor functionality](#)

The information-gathering subsystem module is designed for:

1. Determining the overall parameters of vehicles that passed in camera's view;

2. Gathering information about traffic in general on the basis of vehicles' parameters statistic analysis;
3. Saving the information about traffic to database.

To realize the information-gathering subsystem features the following program modules should interoperate:

1. **IntelliVision vehicle detection**;
2. **Vehicle Processor**.

Use the *Intellect Web Report System* module to create reports based on the results the operation of data acquisition subsystem (see [Intellect Web Report System. User Guide](#)).

5.2.24.1.1 The **IntelliVision vehicle detection** functionality

The **IntelliVision vehicle detection** module is the information-gathering subsystem about traffic in the *Auto-Intellect* software complex.

The module is designed for:

1. Registering vehicle's entrance and exit from the detection zone;
2. Determining the speed of the vehicle;
3. Determining the class of the vehicle;
4. Transmitting the data about the vehicle to the **Vehicle Processor** module for handling and saving to the database.

5.2.24.1.2 The **Vehicle Processor** functionality

The **Vehicle Processor** module is a part of the information-gathering subsystem about traffic in the *Auto-Intellect* software complex.

The module is designed for:

1. Statistic data analysis of vehicles, received from the **IntelliVision vehicle detection** module to gather overall information about vehicles;
2. Saving the data about traffic to the database.

5.2.24.2 Video camera mounting and setup requirements for the **IntelliVision vehicle detection** module

The angle of video camera objective should be around 60° for correct working of the **IntelliVision vehicle detection** module. This condition is defined by the following factors:

1. there are no geometric distortions of image corresponding to objectives with angle more than 60°;
2. objective with angle 60° can cover several road lanes by contrast of long-focus objectives.

Requirements for video camera characteristics:

- Recommended resolution: 360x240, 720x480 or 720x576;
- Recommended frame rate: 25.

Location of video cameras is defined by the following interrelating factors while using the **IntelliVision vehicle detection** module:

- geometric parameters of detection zones;
- covering effect of vehicles moving by neighboring lanes.

Geometry of detection zone while using the **IntelliVision vehicle detection** module is presented in the figure. Video camera is located in the point C. Axis Y is align with video camera pier. Axis X is directed along a road against the current of traffic. Axis Z is perpendicular to a road. Lane of vehicles moving is presented by dashed line. Center of detection zone is presented by point b.

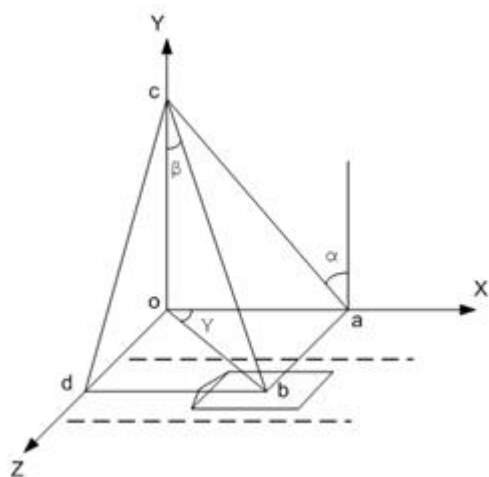

Size of detection zone is selected the following way:

1. length of zone is 6 meters.
2. width of zone is about 2 meters.

Note.

Width of detection zone can be varied to reduce covering effect of vehicles moving by neighboring lanes.

Covering effect of vehicles moving by neighboring lanes is missing if video camera is located strictly above the center of detection zone ("top view to lane").

Note.

In such case point b will coincide with origin of coordinates (see figure).

In other cases covering effect is observed especially for large vehicles.

The lower a video camera pier and the longer its location from center of zone by axis Z, the more significant a covering effect.

It is recommended to mount videocamera the following way:

1. minimal height of video camera suspension is about 8 meters;
2. pier should be located as close to the zone center by axis Z as possible.

It is recommended to mount objective axis perpendicularly to road to minimize value of accuracy error.

5.2.24.3 Traffic data gathering subsystem setup

5.2.24.3.1 Traffic data gathering subsystem setup procedure

Correct operation of Traffic data gathering subsystem is provided by two modules' interaction:

1. **IntelliVision vehicle detection;**
2. **Vehicle Processor.**

5.2.24.3.2 Setting up the IntelliVision vehicle detection parameters

Attention!

Allowable error at determining the number of vehicles is 10% and allowable error at vehicle types recognizing is 15%. Errors determination is performed while moving not less than 1000 vehicles in the camera field of view.

Setting up the **IntelliVision vehicle detection** parameters is done in the following way:

1. Execute the **Intellivision vehicle detection** setup with the **TestAppTMD.exe** utility (see [TestAppTMD.exe utility for setting up the Intellivision vehicle detection](#)).
2. Go to the **Intellivision vehicle detection** object setup panel which is created on the base of the **Computer** object on the **Hardware** tab of the **System settings** dialog box.

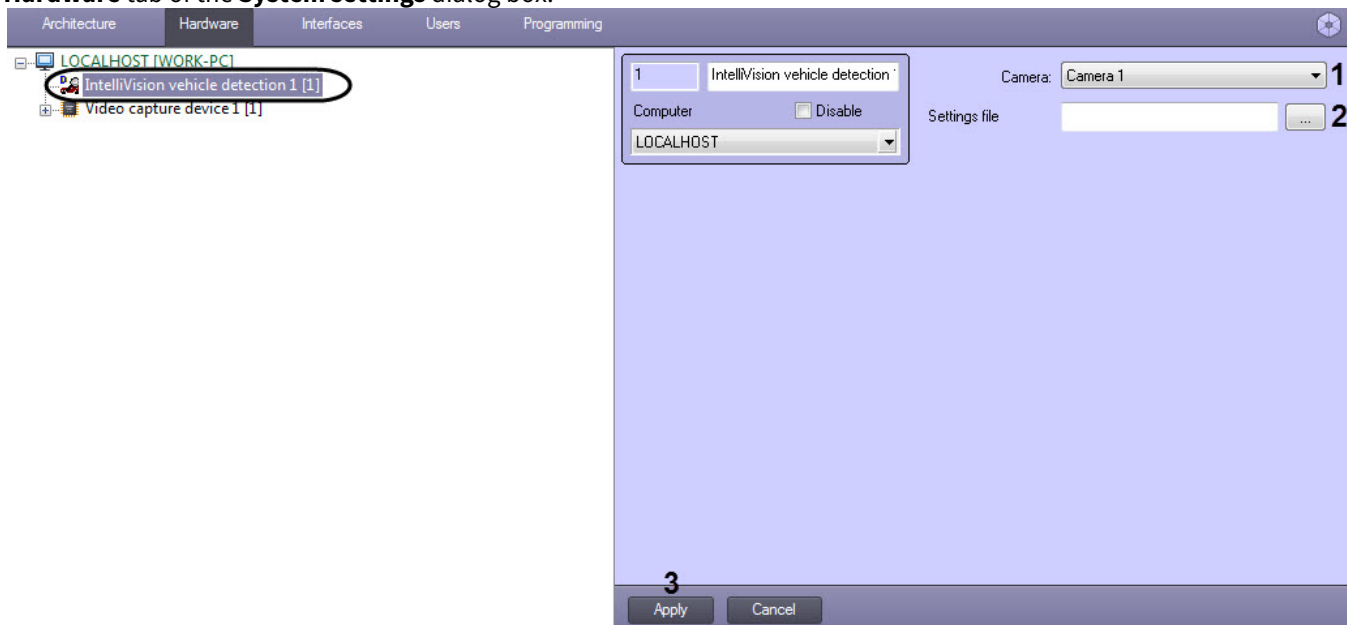

3. From the **Camera** dropdown list select the **Camera** object, corresponding to the camera of the **IntelliVision vehicle detection** (1).
4. Click the button (2) and select the setup file in the **.json** format created with the **TestAppTMD.exe** utility.
5. To save the applied changes click **Apply** (3).

Setting up the **IntelliVision vehicle detection** parameters is completed.

5.2.24.3.3 Setting up the Vehicle Processor module

5.2.24.3.3.1 Vehicle Processor setup procedure

The **Vehicle Processor** module setup procedure:

1. Set up **Vehicle Processor** and **IntelliVision vehicle detection** modules interaction;
2. Select **Vehicle Processor** module's operation;
3. Set the speed of the free stream;
4. If it is necessary to set up the vehicle classification by length.

5.2.24.3.3.2 Setting up the Vehicle Processor and IntelliVision vehicle detection modules interaction

To set up the **Vehicle Processor** and **IntelliVision vehicle detection** modules interaction, do the following:

1. Go to the **Vehicle Processor** object settings panel, which is created on the base of the **Computer** object on the **Hardware** tab of the **System settings** dialog box.

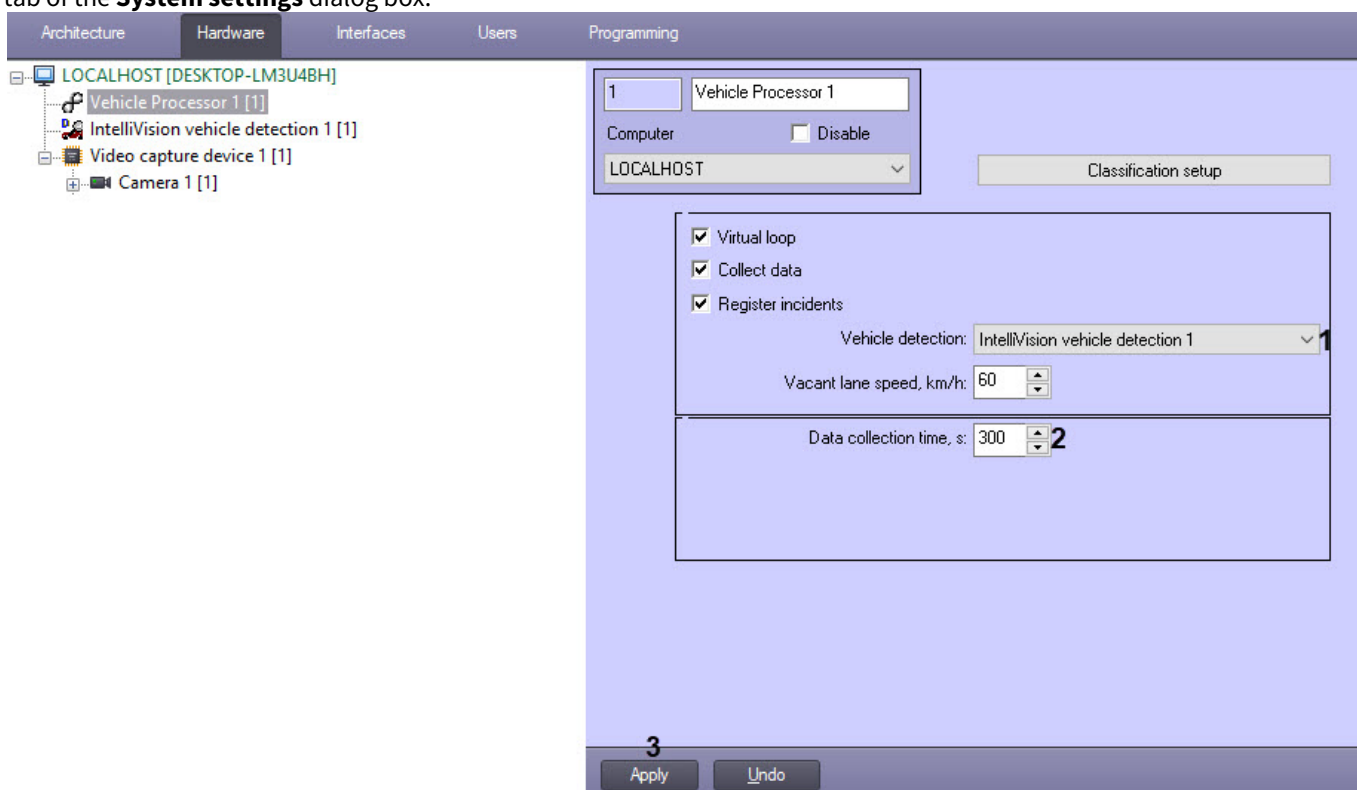

2. From the **Vehicle detection** (1) drop-down list, select the **IntelliVision vehicle detection** module.
3. In the **Data collection time, s** (2) field, enter the time period, during which the **Vehicle Processor** module receives messages from the **IntelliVision vehicle detection** module and makes the averaging of the traffic characteristics. Upon the expiry of this period the data is stored to the **Vehicle Processor** module database.
4. Click the **Apply** (3) button to save the changes.

Setting up the **Vehicle Processor** and **IntelliVision vehicle detection** modules interaction is completed.

5.2.24.3.3.3 Selecting the Vehicle Processor operation mode

To select the **Vehicle Processor** operation mode, do the following:

1. Go to the **Vehicle Processor** object settings panel, which is created on the base of the **Computer** object on the **Hardware** tab of the **System settings** dialog box.

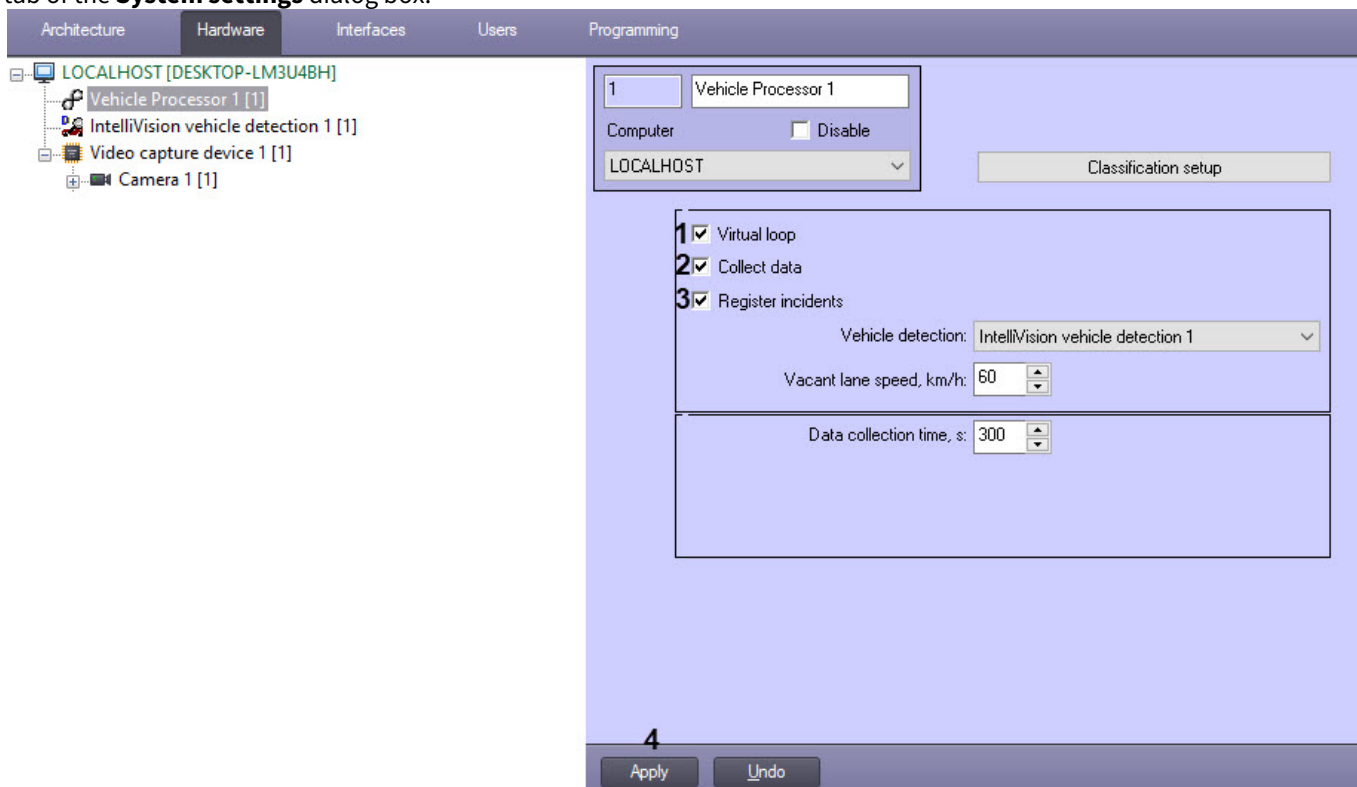

2. To enable the mode of imitating the virtual loop, set the **Virtual loop (1)** checkbox. The result of this mode operation is retranslating the events of vehicles passing in and out from the detection zone, registered by the **IntelliVision vehicle detection** module. By default, the events are retranslated without storing to the Vehicle processor database. To enable storing the events to the database, perform the step 3.

Note

Vehicle speed will be displayed in the **Add. info** column of the **Event viewer** interface object if the **Virtual loop** checkbox is set.

Source	Event	Region	Add. info	Date	Time
LPR channel 1	LP recognized		н763ко163	19-04-16	16:36:29
LPR channel 1	LP recognized		к673ук163	19-04-16	16:36:31
Vehicle Processor 1	Virtual loop		24	19-04-16	16:36:31
Vehicle Processor 1	Virtual loop		34	19-04-16	16:36:33
LPR channel 1	LP recognized		у500ун63	19-04-16	16:36:34
Vehicle Processor 1	Virtual loop		34	19-04-16	16:36:34

3. To enable the mode of collecting and storing vehicles information to the **Vehicle Processor** database, set the **Collect data (2)** checkbox .
4. To enable the registration mode and storing the incidents in the traffic to the **Vehicle Processor** database, set the **Register incidents (3)** checkbox .

Note

At the moment of writing the documentation, only the **Meeting of traffic incidents** are registered.

5. Click the **Apply (4)** button to save the changes.

Selecting the **Vehicle Processor** operation mode is completed.

5.2.24.3.3.4 Setting up the vacant lane speed

The **Vacant lane speed** constant characterizes the detected road area and is stored to the database if, for the time of the data collection, no vehicle has been registered.

To set up the vacant lane speed, do the following:

1. Go to the **Vehicle Processor** object settings panel, which is created on the base of the **Computer** object on the **Hardware** tab of the **System settings** dialog box.

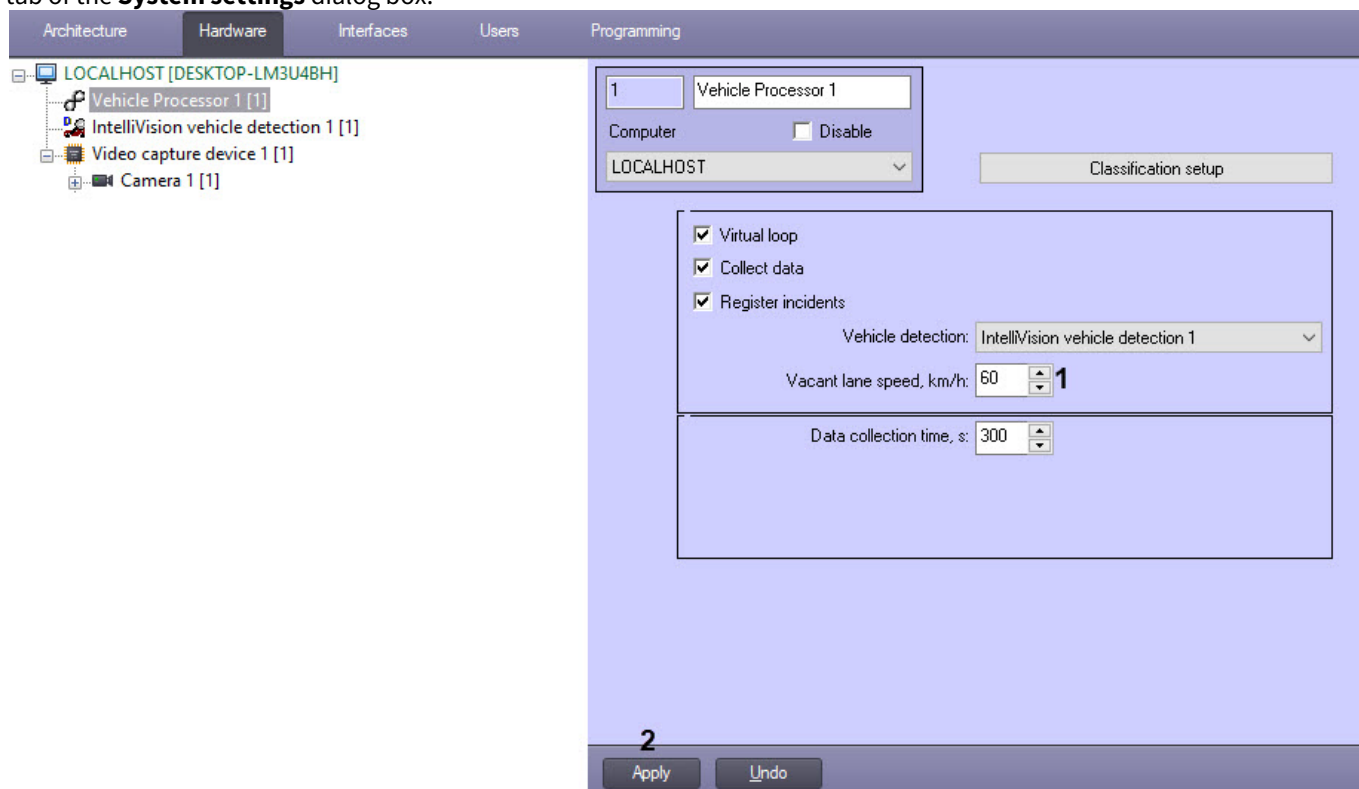

2. In the **Vacant lane speed, km/h (1)** field, enter the speed in km/h of a vacant lane speed in the detection zone.
3. Click the **Apply (2)** button to save the changes.

Setting up the vacant lane speed is completed.

5.2.24.3.3.5 Setting up the vehicles classification according to the length

You can to set up the classification of the detected vehicles according to their length.

To set up the classification of vehicles according to their length, do the following:

1. Go to the **Vehicle Processor** object settings panel, which is created on the base of the **Computer** object on the **Hardware** tab of the **System settings** dialog box.

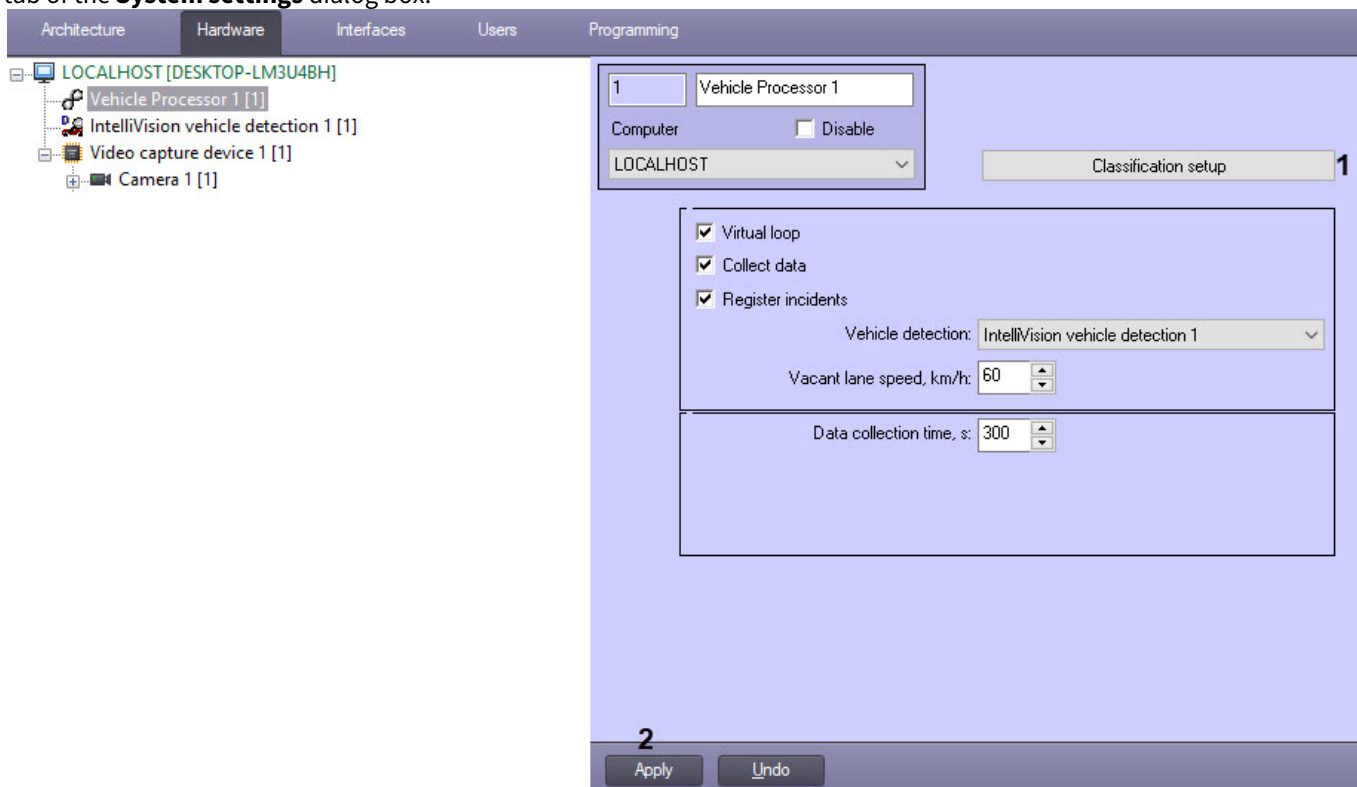

2. Click the **Classification setup** (1) button.
3. The **Vehicle classification setup** dialog window will open.

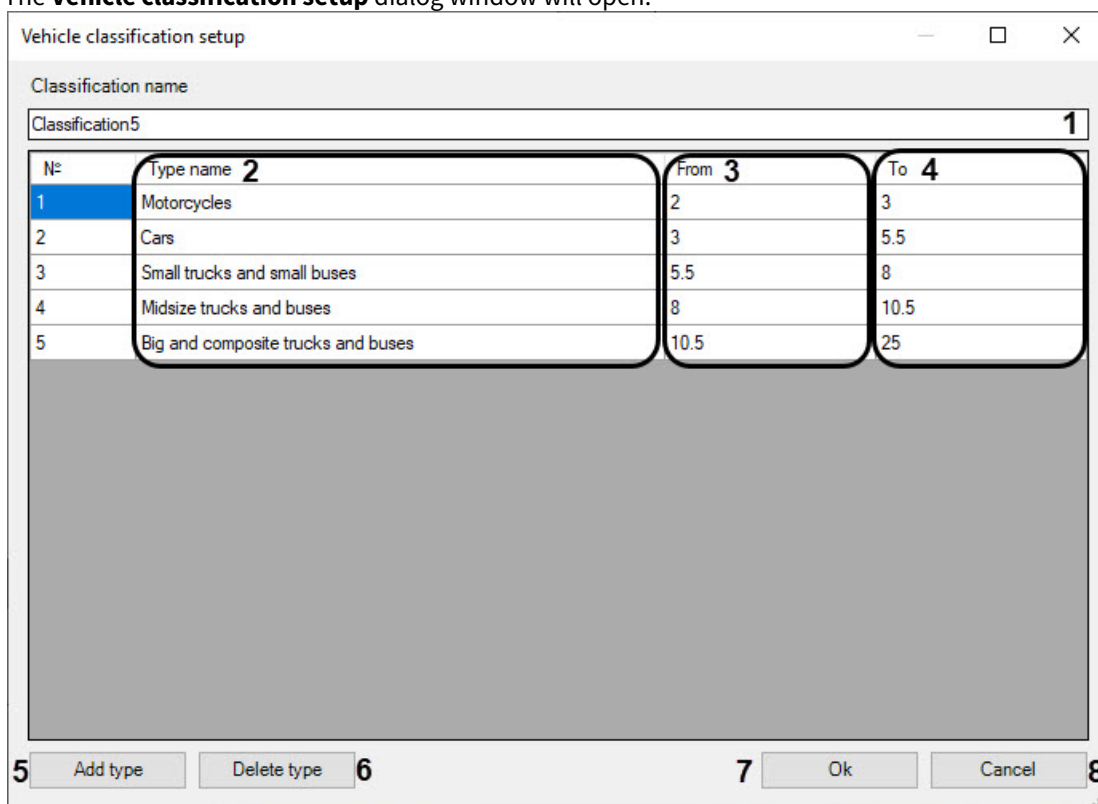

4. In the **Classification name** (1) field, enter the name of the vehicle classification that you want to set up.
5. To edit the types of vehicles, do the following:
 - a. In the **Type name** (2) column, enter the required names of the vehicles types.

- b. In the **From (3)** and **To (4)** columns, set the length ranges of vehicles, belonging to the corresponding types. The values of the range boundaries are entered in meters. The type of the detected vehicle will be determined on the basis of this vehicle's length fitting one of the ranges.

⚠ Attention!

For every pair of vehicles types the length ranges should not intersect.

6. To add a new type of the vehicle to the classification, click the **Add type (5)** button and in the appeared line, perform the steps 5a-5b.
7. To delete a vehicle type from the classification, select a line, corresponding to the required type, and then click the **Delete type (6)** button.
8. Click the **Ok (7)** button to save the changes and close the **Vehicle classification setup** dialog window.

📘 Note

To close the **Vehicle classification setup** dialog window without saving the changes, click the **Cancel (8)** button.

Setting up the vehicles classification according to their length is completed.

5.2.25 Speed traps server

5.2.25.1 The Speed traps server module functionality

The **Speed traps server** software module supports the following functionality:

1. Registering the speed-trap hardware devices designed to determine the vehicle speed;
2. Recording the events with the vehicle speed in the database.

The following speed-trap models are compatible with *Auto-Intellect*:

1. Iskra DA/210;
2. Rapira.

📘 Note

The **Auto-Uragan**, **CARMEN-Auto**, or **VIT** modules also enable determining the vehicle speed by video without using a speed-trap device.

5.2.25.2 Speed-trap mounting and setup requirements for the Speed traps server module

The speed-traps should be mounted and set up according to their documentation.

📘 Note.

If the **Speed traps server** software module is used together with the **Traffic Detection** module, the speed-trap capture zone should be right next to the capture area of the loop detector of the **Traffic Detection** module in the direction of traffic movement.

5.2.25.3 The Speed traps server software module setup

The **Speed traps server** software module is designed for the installation and setup of speed-trap devices in the system.

During the **Speed traps server** module configuration, it is necessary to specify the connection and operation settings of the speed-trap device, as well as the vehicle speed detection parameters.

5.2.25.3.1 The Speed traps server module setup procedure

To set up a speed-trap device in *Auto-Intellect*, the system object corresponding to the **Speed traps server** software module should be created and set up.

The **Speed traps server** object setup includes the following steps:

1. Set up the connection between the Speed-trap device and the *Auto-Intellect* software package.
2. Select a camera for the joint operation of the **Speed traps server** and **Auto-Urgan, CARMEN-Auto** or **VIT** modules.
3. Specify the speed limit.
4. Setting the permitted vehicle speed for displaying in the report concerning the recognized number.
5. Select the model and installation type of a Speed-trap device.
6. Select the vehicle movement direction relative to the Speed-trap, needed to determine the vehicle speed.
7. Specify the distance between the speed-trap and the vehicle position at the moment of speed detection.
8. Set up additional parameters related to joint operation of the speed-trap device and the **Speed traps server** module.
9. Specify the minimum vehicle speed to be detected by the speed-trap.

5.2.25.3.2 Setting up the speed-trap device connection to the server

Speed-traps are connected to the server via the COM port. Any number of speed-trap devices can be connected to *Auto-Intellect*, depending on customer needs.

Specialized protocol is used for data exchange with the speed-traps via the COM port. Each Speed-trap uses its individual protocol for data exchange.

Several COM ports should be set up one by one. Each speed-trap device is represented by a separate **Speed traps server** object created and set up in the **Hardware** tab of the **System Settings** window.

To set up a COM port for speed-trap connection, do the following:

1. Go to the **Speed traps server** server object settings panel (2).

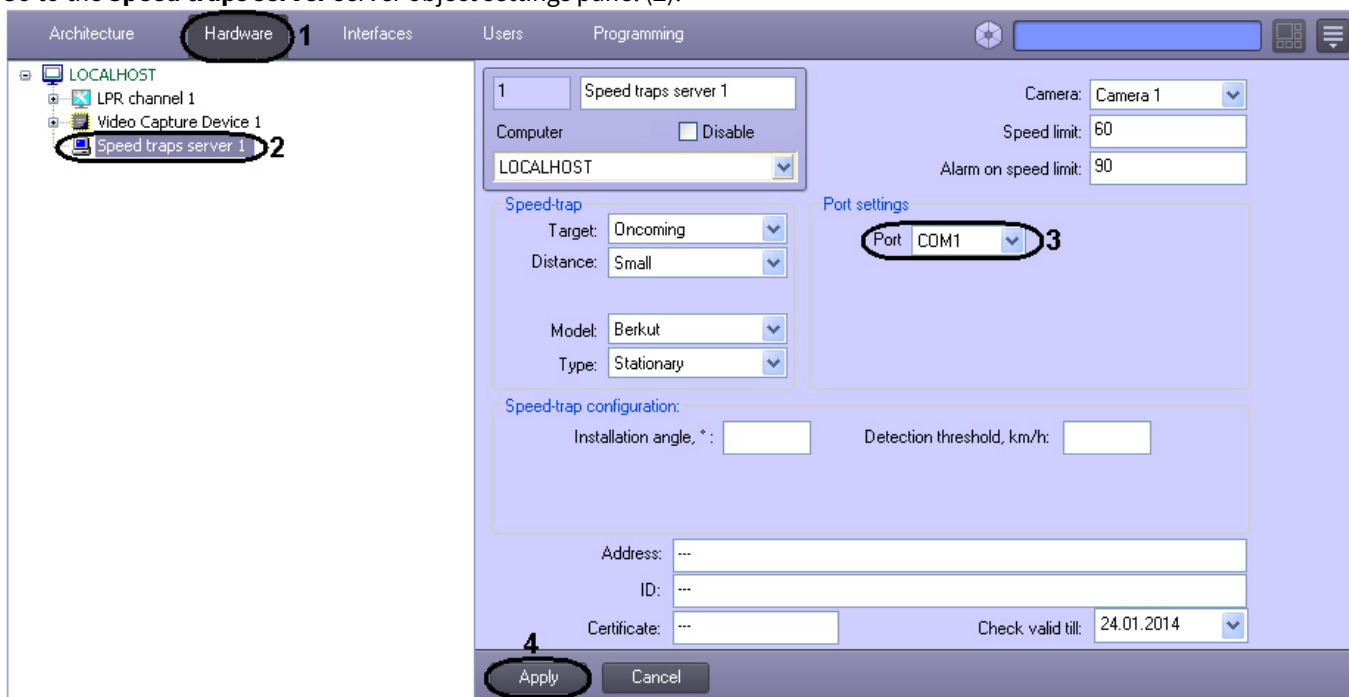

2. In the **Port** drop-down list, select the COM port to connect the speed-trap (3).
3. Click **Apply** (4) to save all changes.

The speed-trap is now connected to the server.

5.2.25.3.3 Selecting the video camera for Speed traps server and LPR channel joint operation

For the joint operation of the **Speed traps server** software module and the **LPR channel**, it is necessary to specify a video camera that is configured to work with the **LPR channel**. To do this, follow these steps:

1. Go to the **Speed traps server** object settings panel (2).

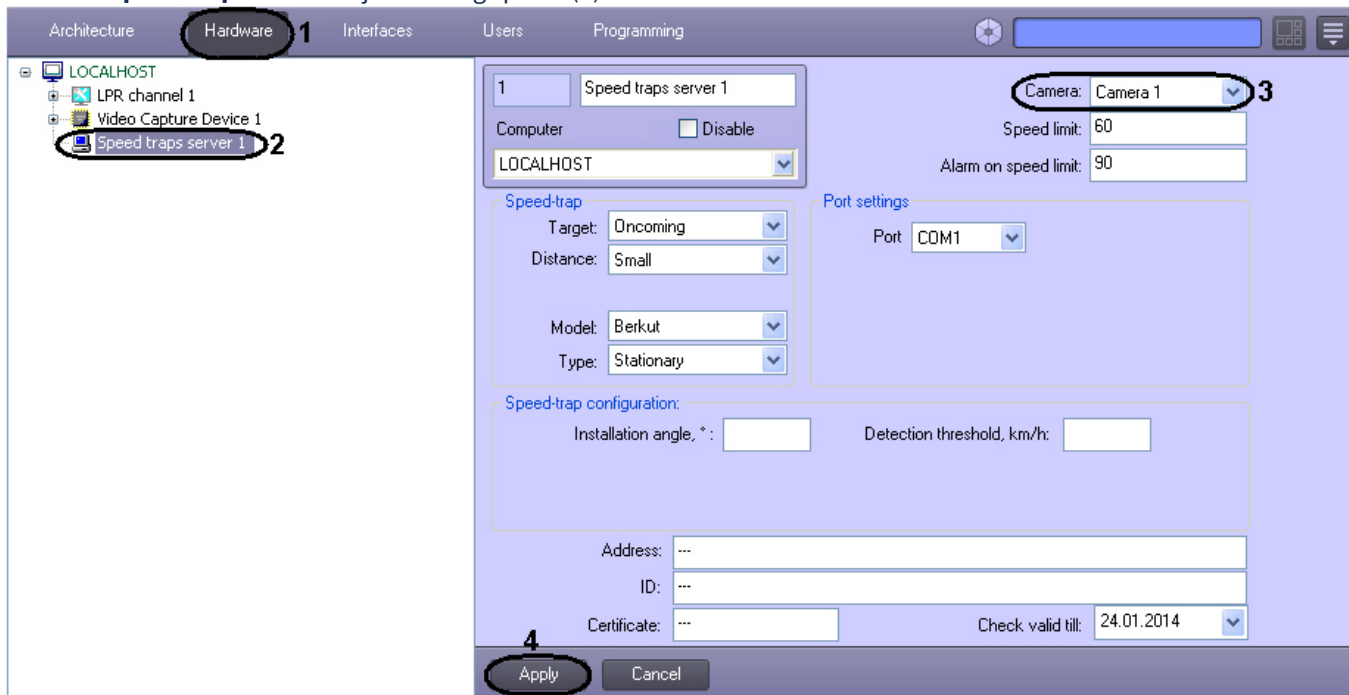

2. From the **Camera** drop-down list, select the Camera object that is used to work with the **LPR channel** (3).
3. Click **Apply** to save all changes (4).

The camera selecting for **Speed-trap server** and **LPR channel** joint operation is completed.

5.2.25.3.4 Setting up the vehicle speed

The allowed driving speed can be set up for the **Speed traps server** software module, as well as the maximum driving speed. If a vehicle exceeds the specified speed limit, the system generates a speeding event.

To set the speed, do the following:

1. Go to the **Speed traps server** object settings panel (2).

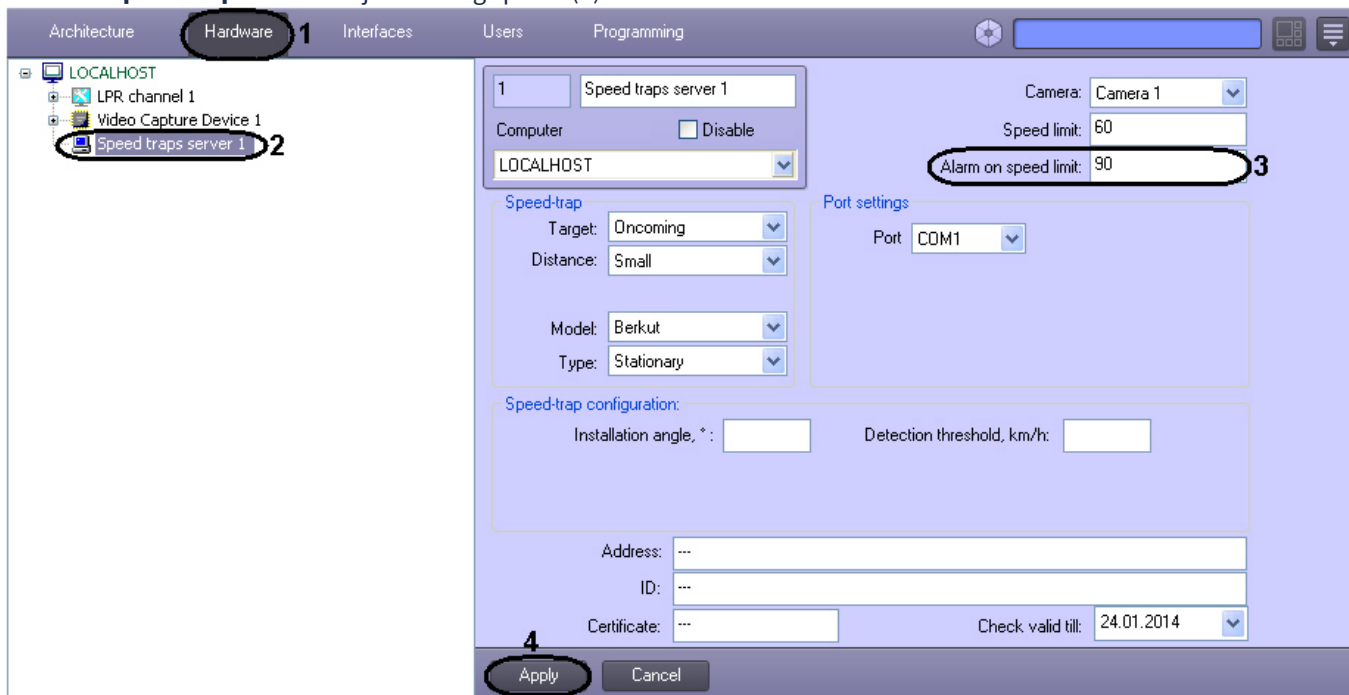

2. In the **Speed limit** field enter the allowed driving speed in km/h.

3. In the **Alarm on speed limit** field enter the maximum allowed driving speed in km/h (3).
4. Click **Apply** (4).

The speed is now set up.

5.2.25.3.5 Selecting the model and installation type of a Speed-trap device

To select the model and installation type of a Speed-trap device, do the following:

1. Go to the **Speed traps server** object (2).

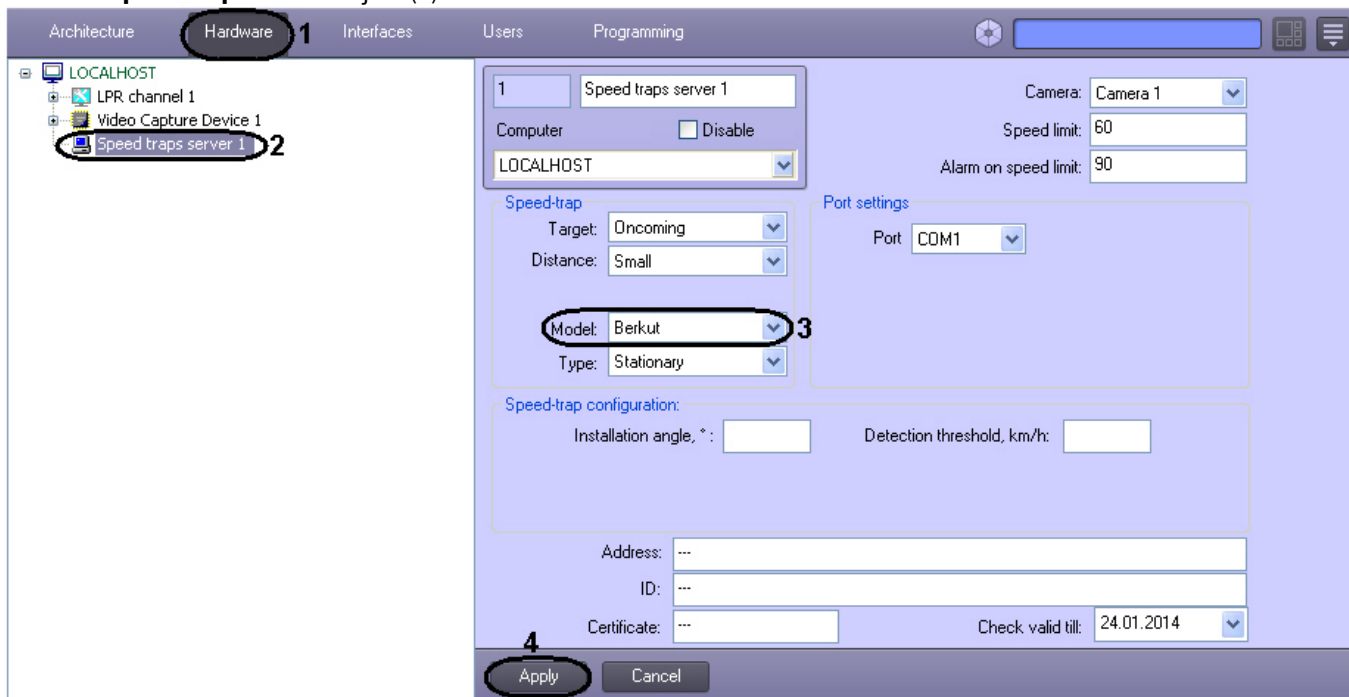

2. From the **Model** drop-down list (3) select the model of the supported installed Speed-trap device.



Attention!

Correct operation of the *Iskra-1*, *Iskra-1B*, *Iskra-1D*, *Iskra-1KRIS* models is not guaranteed.

3. From the **Type** drop-down list select the installation mode of Speed-trap device:
 - **Stationary** - if the Speed-trap device is installed stationary.
 - **Moving** - if the Speed-trap device is installed on moving vehicles.



Note

The availability of the **Type** drop-down list depends on the selected Speed-trap device model.

4. Click **Apply** (4).

The process of selecting the module and installation mode of Speed-trap device is completed.

5.2.25.3.6 Selecting the vehicle movement direction and distance

To select the vehicle movement direction and distance, do the following:

1. Go to the **Speed traps server** object (2).

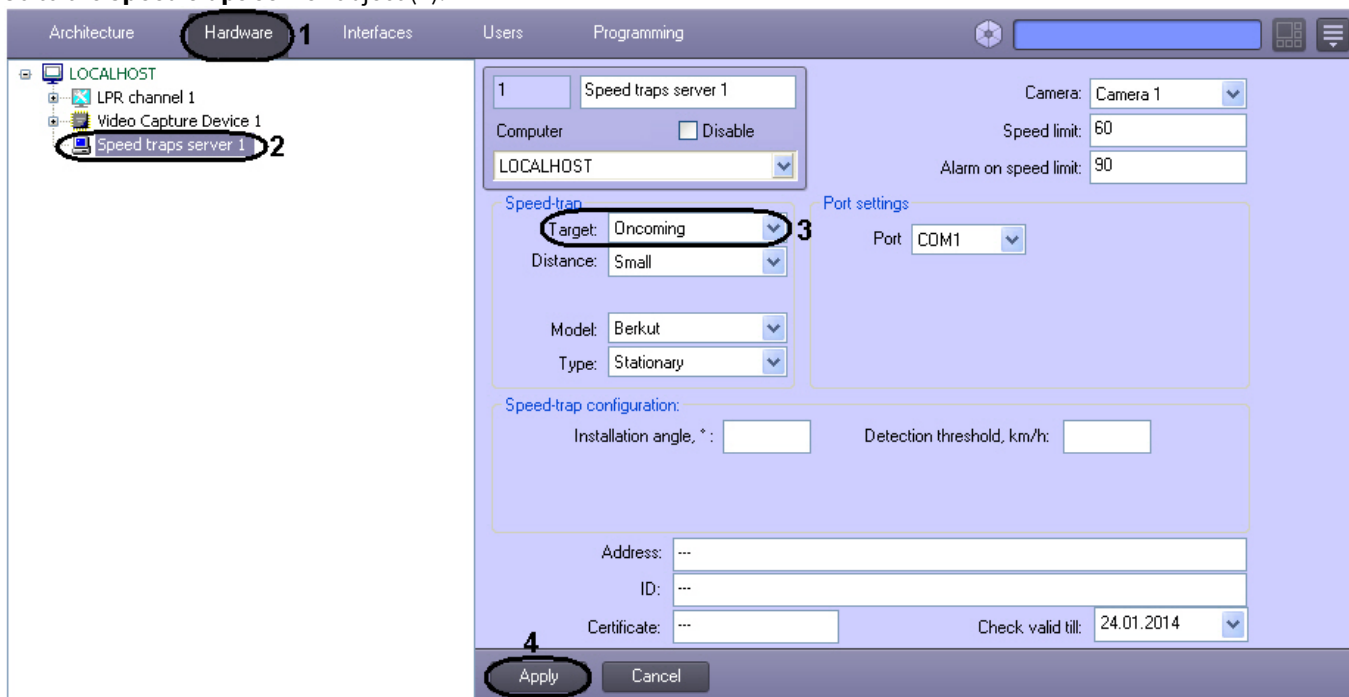

2. From the **Target** drop-down list (3), select the vehicle direction relative to the Speed-trap device to determine its speed of movement.
 - **Automatically** - to automatically determine the vehicles speed moving relative to the Speed-trap device;
 - **Oncoming** - to determine the vehicles speed moving oncoming to the installed Speed-trap device;
 - **Passing** - to determine the vehicles speed moving from the installed Speed-trap device.
3. When configuring the **Auto-URAGAN** or **CARMEN-Auto** software modules, from the **Distance** drop-down list, select the distance from the Speed-trap device to the place where the vehicle speed is determined.

Note

- The physical distance from the Speed-trap device to the place where the speed is determined is indicated in the documentation for the Speed-trap device.
- The value of the **Distance** parameter is determined experimentally.

4. Click **Apply** (4).

The vehicle movement direction and distance is now selected.

5.2.25.3.7 Setting up the Speed-trap device

To configure the Speed-trap device, do the following:

1. Go to the **Speed traps server** object (2).

The screenshot shows the configuration window for a Speed traps server. The 'Hardware' tab is active, and the tree view on the left shows 'Speed traps server 1' selected. The configuration fields are as follows:

- Name:** Speed traps server 1
- Computer:** LOCALHOST
- Camera:** Camera 1
- Speed limit:** 60
- Alarm on speed limit:** 90
- Speed-trap settings:** Target: Oncoming, Distance: Small, Model: Berkut, Type: Stationary
- Port settings:** Port: COM1
- Speed-trap configuration:** Installation angle, °: 3, Detection threshold, km/h: (empty)
- Address:** ---
- ID:** ---
- Certificate:** ---
- Check valid till:** 24.01.2014

The 'Apply' button is circled with a '4'.

2. In the **Installation angle, *** field (3), enter the inclination angle at which the Speed-trap device is installed above the traffic lane (see the official documentation for the Speed-trap device).

Note.

Depending on the Speed-trap device model, the system may ignore this option if it is not applicable to that particular speed-trap model (see the official documentation for the Speed-trap device).

3. In the **Detection threshold km/h** field, enter the minimum vehicle speed determined by the Speed-trap device. For vehicles moving slower than a given threshold, the speed will not be determined by the Speed-trap device.
4. Click **Apply** (4).

The Speed-trap device is now set up.

5.2.25.3.8 Specifying the Speed-trap device information to be displayed in the recognized number report

To specify the Speed-trap device information to be displayed in the recognized number report, do the following:

1. Go to the **Speed traps server** object (2).

2. In the **Address** field (3), enter the location of Speed-trap device.
3. In the **ID** field (4), enter the factory ID of Speed-trap device.
4. In the **Certificate** field (5), enter the certificate number, that corresponds to Speed-trap device.
5. From the **Check valid till** drop-down list (6), select date, until that verification of Speed-trap device is valid.
6. Click **Apply** (7).

Specifying the Speed-trap device information to be displayed in the recognized number report is completed.

5.2.25.4 Joint operation of the LPR channel and Speed traps server modules

The **LPR channel** module can operate together with the **Speed traps server** module. In this case, each vehicle recognized by the **LPR channel** module is compared to the speed value set specified in the Speed-trap device.

Note.

This settings is specified only when the **Auto-Uragan**, **CARMEN-Auto** or **VIT** program modules are in use.

To set up the joint operation of the **LPR channel** and **Speed traps server**, do the following:

1. Go to the **LPR channel** object settings panel, corresponding to the activated **Auto-Uragan**, **CARMEN-Auto** or **VIT** program module (see [Activating the software module used for identifying the plates](#)).

- Go to the **Speed camera settings** tab (1).

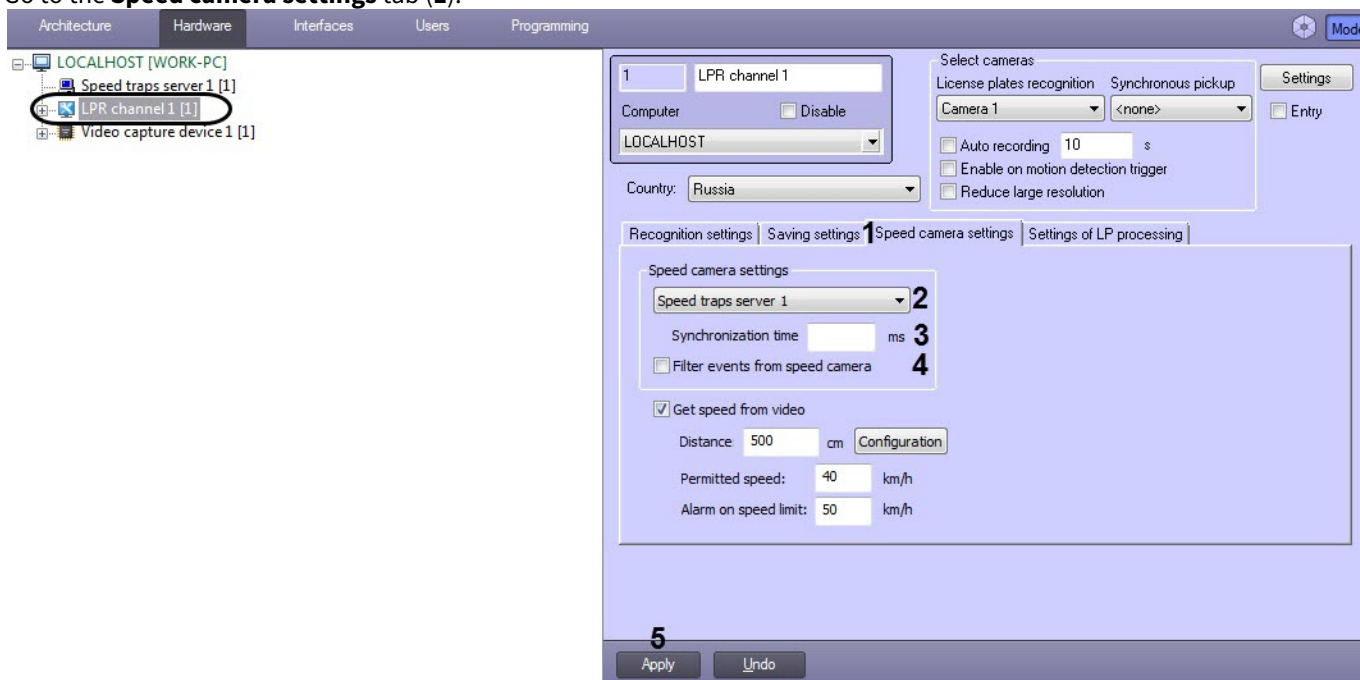

- In the **Speed camera settings** drop-down list (2), select the **Speed traps server** object representing the speed-trap device directed at the same lane as the LPR channel camera.
- In the **Synchronization time** field (3), enter the time period in milliseconds that it takes the vehicle to drive from the spot of speed detection by the speed-trap to the viewing zone of the LPR channel recognition video camera.

Note.

Synchronization time is needed to synchronize the operation of the **Speed traps server** and the **LPR channel** modules.

- Set the **Filter events from speed camera** checkbox (4) if it is necessary to record only the first speed value detected by the speed-trap device, while other values are ignored until the delay expires or until the LP number is recognized.
- Click **Apply** (5).

The joint operation of the **LPR channel** and **Speed traps server** modules is complete.

5.3 Setting up the LPR channel

5.3.1 Selecting the video cameras to work with the LPR channel

To set up the **LPR channel**, specify the main camera for LP number recognition, and an additional synchronous camera, if necessary.

The main recognition video camera is directed at the driving lane. The additional video camera covers the same area as the main video camera, but it can be mounted in another place. The two video cameras can be controlled synchronously using scripts or macros.

Example. Gas filling station. The main video camera is directed at the incoming lane and recognizes the LP numbers of approaching cars. The additional synchronous video camera is mounted at the side of the lane and monitors the fueling process.

To select the video cameras, do the following:

- Go to the **LPR channel** object settings panel, corresponding to the activated module (see [Activating the software module used for identifying the plates](#)).

- From the **License plates recognition** drop-down list (1), select a required **Camera** object (the main camera for LP number recognition).

Note

The same camera can be used for various **LPR channels**.

- From the **Synchronous recording** drop-down list (2), select a required **Camera** object (the additional synchronous camera). To get a contextual frames from an ANPR camera, you must select the same camera that is selected as the main one.

Attention!

Frames recording from the synchronous video camera is performed only if permanent record by both video cameras is performing.

- If it is necessary for the **LPR channel** to consider the vehicle's movement direction as **Entry** to the territory, set the **Entry** checkbox (3).

Note

This setting is taken into account in the *Intellect Web Report System* when working with Auto reports (see [Intellect Web Report System. User Guide](#)).

- Click the **Apply** button (4).

The camera selection is completed.

5.3.2 Setting up the video recording parameters

It is possible to record a video signal received from a LP recognition video camera during a predetermined time interval. If this function is enabled, the recording starts automatically when the LPR channel recognizes an LP number.

Note.

In case of heavy traffic, when subsequent LP numbers are registered in a time period smaller than that specified, the video signal is recorded continuously.

To enable automatic recording functionality, do the following:

1. Go to the **LPR channel** object settings panel, corresponding to the activated module (see [Activating the software module used for identifying the plates](#) section).

The screenshot shows the configuration interface for an LPR channel. At the top, there are fields for channel ID (1), name (LPR channel 1), computer (LOCALHOST), and country (Russia). Below these are options for license plates recognition (13) and synchronous recording (<none>). A 'Settings' button is present. The 'Auto recording' checkbox is checked and marked with a '1', with a duration of 10 seconds marked with a '2'. Other options include 'Enable on motion detection trigger' and 'Reduce large resolution'. The interface has several tabs: 'Recognition settings', 'Saving settings', 'Speed camera settings', and 'Settings of LP processing'. The 'Recognition settings' tab is active, showing 'Detection settings' with 'Area search threshold' (30), 'Max. width' (21), and 'Max. height' (9). 'Search area border, %' is set to 0 for all directions (Left, Top, Right, Bottom), and the 'Search area' checkbox is checked and marked with a '3'. 'Direction calculation' is set to 'by LP position' and 'Direction' is set to 'any'. The 'Undefined' and 'Record violation' checkboxes are checked. At the bottom, there are 'Apply' and 'Undo' buttons.

2. Set the **Auto recording** checkbox to enable recording the video upon recognizing an LP number (1).

Note.

For correct auto recording when working with the **IntLab** program module specify the **Pre-alarm record** parameter in the settings panel of the **Camera** object (see [Configuring video in the Pre-alarm record mode](#)).

3. In the field next to the checkbox (2), specify for how many seconds the video should be recorded after LP number recognition.

Note.

Zero (0) in this field means that the recording starts at the moment of LP recognition and continues indefinitely.

4. Click **Apply (3)**.

The auto recording setup is complete.

5.3.3 Setting up the LP storage and the database records retention period

5.3.3.1 Configuring the database records retention period

Registry keys reference guide

All the events *Auto Intellect* receives from the **LPR channel**, are stored in the SQL database. Eventually it reaches large size, which leads to the Server CPU load increase. To limit the SQL database size you can specify the database records retention period.

Note

In case the database records retention period is specified shorter than before while configuring the LPR channel, the database will gradually clean itself.

If the **Debug 4** debugging mode is enabled, then when the SQL database queue reaches 1000 or more queries, the events will be generated in the *Event Log* every 10 seconds indicating the current queue until the queue is less than 1000 (for details, see [Enabling the Debug window](#)).

To configure the database records retention period, do the following:

1. Go to the **LPR channel** object settings panel, corresponding to the activated module (see [Activating the software module used for identifying the plates](#) section).

- Go to the **Saving settings** tab (1).

The screenshot shows a settings window with several tabs: 'Recognition settings', 'Saving settings', 'Speed camera settings', and 'Settings of LP processing'. The 'Saving settings' tab is active and highlighted with a red circle and the number 1. In this tab, there are several options:

- Record frames to SQL DB
- Show captions
- Deinterlace
- Ratio 4:3
- Archive size, days: 30 (highlighted with a red circle and the number 2)
- Settings of results filtering:
 - Min. number of characters in LP
 - Min. recognition quality, %
 - Min. time of LP repetition, s

 At the bottom of the window, there are 'Apply' and 'Undo' buttons. The 'Apply' button is highlighted with a red circle and the number 3.

- In the **Archive size, days** field (2), specify the number of days that records are stored in the database. The default value is 30. The value range is 0-5000.
- Click the **Apply** button (3).

The database records retention period is configured.

5.3.3.2 Recognized LP images and vehicle images storing modes

When the LP number is recognized by the **LPR channel**, this event and the corresponding metadata is recorded to the *Auto Intellect* database. The video image of the vehicle which LP number was recognized, and the LP image itself can also be recorded and stored.

There are two modes of storing the recognized LP images and vehicle images:

- In the *Auto Intellect* database (see [Configuring recognized LP images and vehicle images storage in Auto Intellect database](#) for details)
- In the folder on the disk (see [Configuring the recognized LP images and vehicle images storage on disk](#) for details).

5.3.3.3 Configuring recognized LP images and vehicle images storage in Auto Intellect database

Note

Storing the recognized LP images and vehicle images in the *Auto Intellect* database rapidly increases its size. It leads to the Server CPU load increase.

To enable storing the recognized LP images and vehicle images in the *Auto Intellect* database, do the following:

1. Go to the **LPR channel** object settings panel, corresponding to the activated module (see [Activating the software module used for identifying the plates](#) section).
2. Go to the **Saving settings** tab (1).

The screenshot shows the 'LPR channel 1' settings window. The 'Saving settings' tab is selected. The 'Record frames to SQL DB' checkbox is checked. The 'Show captions' checkbox is checked. The 'Deinterlace' checkbox is unchecked. The 'Ratio 4:3' checkbox is checked. The 'Archive size, days' is set to 30. The 'Settings of results filtering' section has three empty input fields for 'Min. number of characters in LP', 'Min. recognition quality, %', and 'Min. time of LP repetition, s'. The 'Apply' button is highlighted with a red '6'.

3. Check the **Record frames to SQL DB** box (2) to enable storing the recognized LP images and vehicle images in the *Auto Intellect* database.

Note

Captions with the recognized LP info can overlay the video image which is stored in the LP numbers database. If this option is enabled, the captions overlay the video image when viewing the full info about the vehicle with the recognized LP number.

Check the **Show captions** box (3) to enable the video image overlaying with the captions when generating the recognized LP number report.

4. In case the video image is received in full resolution, check the **Deinterlace** box (4) to enable the vehicle image deinterlacing.
5. If the video image in the recognized LP number report should be displayed with the 4:3 image aspect ratio, check the **Ratio 4:3** box (5).
6. Click **Apply** (6).

Note

You can export the recognized LP images and vehicle images from the Auto Intellect database to the disk using the *LprFsTool.exe* utility (see [LprFsTool.exe utility for loading images of recognized license plates from database to disk](#)).

5.3.3.4 Configuring the recognized LP images and vehicle images storage on disk

The recognized LP images and vehicle images storage on disk depends on the following registry keys (see [Registry keys reference guide](#) for details. For information about system registry, refer to [Working with Windows OS registry](#)):

- **LprDB.Use**: Specifies the recognized LP images and vehicle images storing mode. By default, the key value is **1**.

- **LprDB.Path:** Specifies the local or network folder for storing the recognized LP images and vehicle images. The default folder is **C:\ProgramData\AxxonSoft\LprDB**.
- **LprDB.FreeMB:** Specifies the amount of free storage space in a directory. When the limit is exceeded, the overwriting process starts, rewriting the oldest images with the most recent ones. By default, it's **5000 MB**.

The recognized LP images and vehicle images storing modes depending on the specified **LprDB.Use** key value are described in the table below.

LprDB.Use	Storing mode
0	The recognized LP images and vehicle images are stored either in the <i>Auto Intellect</i> database, or nowhere.
1	The recognized LP images and vehicle images are stored in the folder specified in the LprDB.Path key. The disk space limit of this folder is specified in the LprDB.FreeMB key.

To change the storing mode, specify the appropriate value for the **LprDB.Use** key corresponding to the necessary mode of storing the recognized LP images and vehicle images.

To select the local or network folder for storing the recognized LP images and vehicle images, specify the folder path as the **LprDB.Path** key value.

To set the amount of free storage space in a directory, upon reaching which the images will be overwritten on a loop, specify the corresponding value in megabytes as the **LprDB.FreeMB** key value.

Important!

If the recognized LP images and vehicle images storing on disk is enabled, the **Record frames to SQL DB** parameter (see [Configuring recognized LP images and vehicle images storage in Auto Intellect database](#)) is not taken into account.

Note

You can access the images stored in the folder on disk using the HTTP GET-requests (see [Image receiving by the ID](#)).

Configuring the recognized LP images and vehicle images storage on disk is complete.

5.3.4 Setting up the LPR channel detector

To set up the detector parameters, do the following:

1. Go to the settings panel of the **LPR channel** object corresponding to the activated software module (see [Activating the software module used for identifying the plates](#)).

Note

Parameters availability depends on activated software modules (for details, see [The LPR channel object settings panel](#)).

2. Enter the value in the **Area search threshold** field (1).
3. Set the **Max. width** and **Max. height** parameters:

- a. Click the  (2) button next to the parameters. Interactive interface of setting up the zone parameters showing the image from the corresponding camera will be displayed.



- b. At the appropriate moment, click the **Stop video** button and then hold the mouse while dragging it across the required area and click **OK** button.

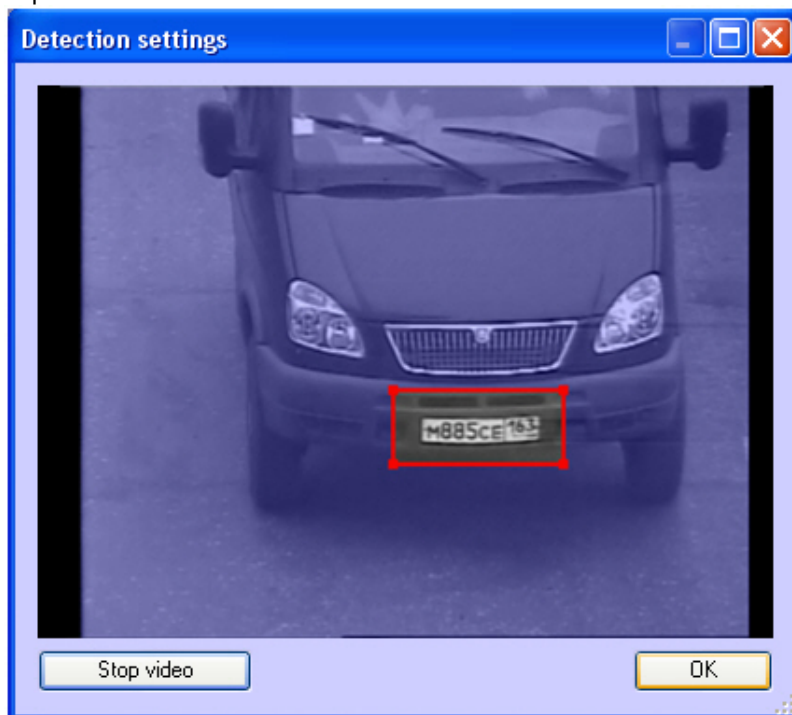

 **Note.**

You can select the zone in the **Real Time Video** mode as well.

Results of setting the parameters will be automatically entered in the **Max. width** and **Max. height** fields.

 **Note**

It is not recommended to set maximum sizes greater than required, as this slows down the processing, but does not improve the quality of recognition.

4. Set the **Min. width** and **Min. height** parameters by analogy with **Max. width** and **Max. height** parameters using the  button (3).
5. If necessary, set the **Cut image with vehicle** checkbox (4).

 **Note.**

The **Cut image with vehicle** option is used only when working with megapixel video surveillance cameras.

6. If necessary, set the **Allow recognition on demand** checkbox (5).
7. Click **Apply** button (6).

The LPR channel settings are now completed.

5.3.5 Setting the LP number search area border

By default, the LPR channel scans the whole video image received from the camera for the LP number. To decrease the CPU load, a smaller area where the LP should be searched for, can be specified.

 **Note**

- If the LP search area border is specified, only the LPs that completely fit into the area will be recognized.
- To ensure the correct LP recognition, camera captions should not overlap the LP search area.

The search area borders can be specified using one of two methods:

1. Manual entry of the area coordinates;
2. Setting the borders on the video image using the mouse.

To manually enter the exact values of the search area borders, do the following:

1. Go to the **LPR channel** object settings panel, corresponding to the activated module (see [Activating the software module used for identifying the plates](#)).

The screenshot shows the 'LPR channel 2' settings panel. At the top, there are fields for 'Computer' (LOCALHOST), 'Country' (Russia), and 'Select cameras' (ity1). Below these are checkboxes for 'Auto recording', 'Enable on motion detection trigger', and 'Reduce large resolution'. The main section is divided into tabs: 'Recognition settings', 'Saving settings', 'Speed camera settings', and 'Settings of LP processing'. The 'Recognition settings' tab is active, showing 'Detection settings' (Area search threshold: 30, Max. width: 21, Max. height: 9, Min. width, Min. height) and 'Search area border, %' (Left: 0, Top: 0, Right: 100, Bottom: 100). A 'Search area' checkbox is checked. The 'Direction calculation' section shows 'by LP position' and 'Direction' set to 'any'. At the bottom, there are 'Apply' and 'Undo' buttons.

2. Set the **Search area** checkbox (**1**) to enable specifying the search area borders.
3. In the **Left**, **Top**, **Right**, and **Bottom** fields (**2**), specify the required values. These values correspond to the search area borders percentage of the full frame size.
To specify the search area borders using the mouse, do the following:

- a. Click the  (3) button. The **Search area border, %** window will appear. In this window, do the following:

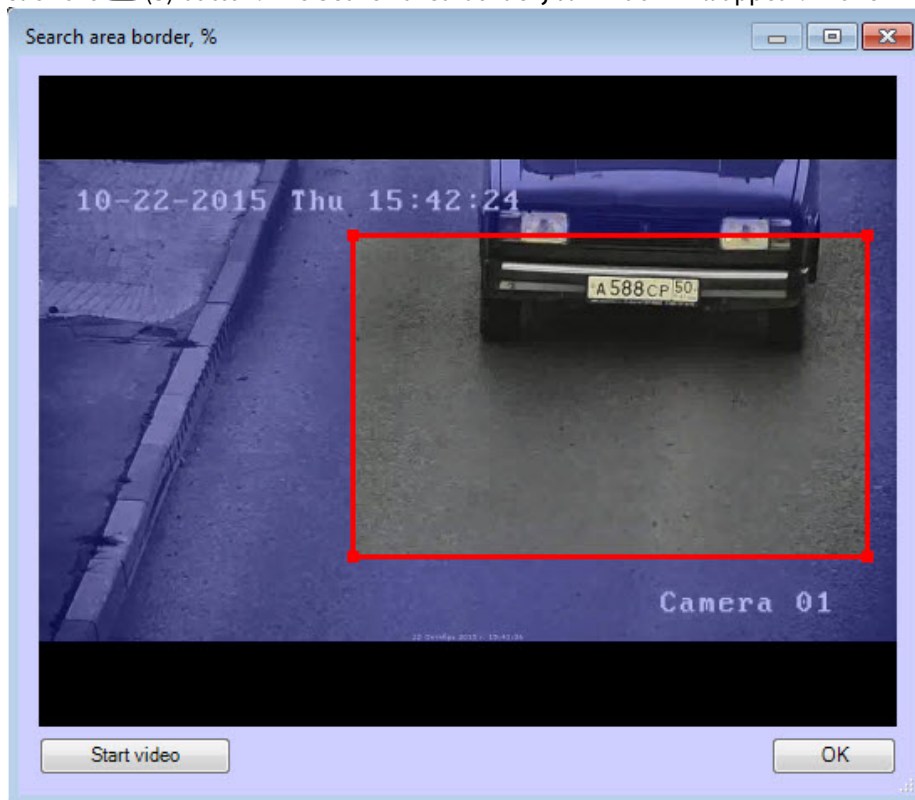

- b. left-click and hold the mouse button on the video image at one of the corners of the supposed search area;
c. keep the mouse button pressed and drag the pointer across the supposed search area to the opposite corner;
d. release the mouse button;
e. click the **OK** button to save the selected area.

 **Note**

If you use **VIT** or **Roadar** software modules, you can specify search area borders of any shape.

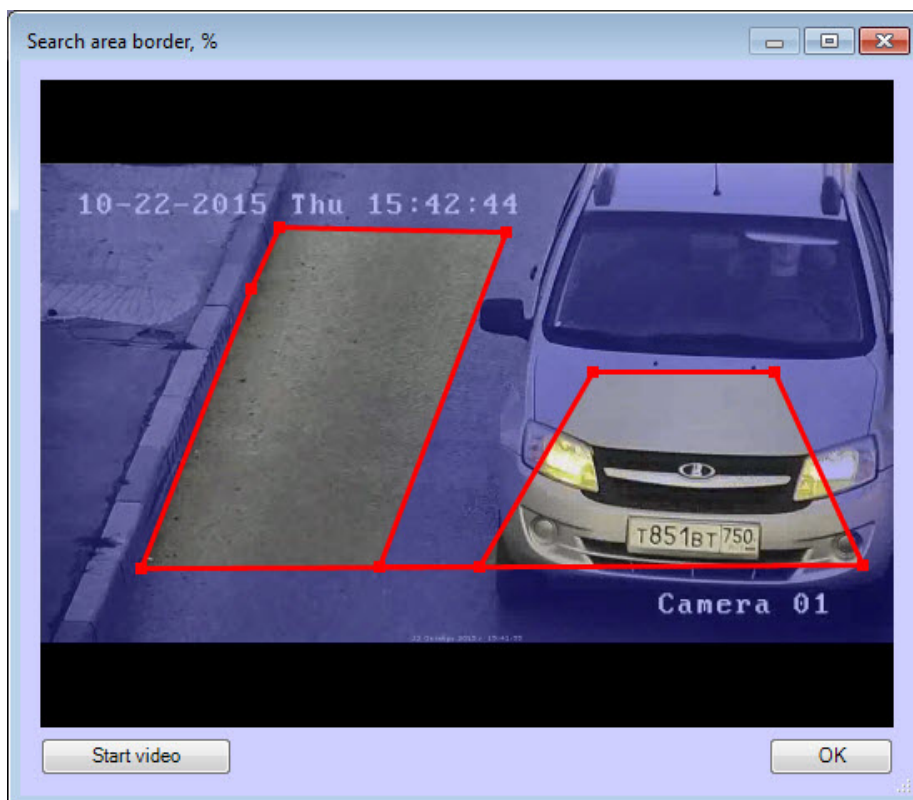

To specify non-rectangular search area borders, set the anchor points of the required shape with the left mouse button. After you set the last anchor point, click the right mouse button, and the shape will automatically close.

4. Click the **Apply** button (4).

The LP search area border is now set up.

5.3.6 Selecting the country and license plate recognition SDK

On this page:

- [General information](#)
- [Selecting the country for license plate recognition](#)
- [Selecting the license plate recognition SDK](#)

5.3.6.1 General information

While setting the LPR channel with active **AUTO-Uragan/VIT/RoadAR/LPR IntelliVision** module, it is necessary to specify the country to be able to identify the plates belonging to that country.

Note.

The list of supported countries for a recognition module is given in its functionality description in [Configuring the Auto-Intellect software package and setting up its components](#).

The plates of the selected country will be recognized with maximum probability. The plates which do not fit the plate format of the selected country will still be recognized, although with lesser probability.

While setting the LPR channel with active **CARMEN-Auto/ARH-Railway/ARH-Containers** module, it is necessary to specify the license plate recognition SDK.

5.3.6.2 Selecting the country for license plate recognition

To select the country, do the following:

1. Go to the settings panel of the **LPR channel** object representing the activated recognition module.

The screenshot shows the configuration interface for an LPR channel. At the top, there are fields for channel ID (1), name (LPR channel 1), computer (LOCALHOST), and a 'Disable' checkbox. Below these is the 'Country' dropdown menu, which is currently set to 'Russia' and is marked with a red circle and the number '1'. To the right, there are settings for camera selection, license plate recognition (set to 13), and synchronous recording (set to <none>). There are also checkboxes for 'Auto recording' (set to 10s), 'Enable on motion detection trigger', and 'Reduce large resolution'. The main section is titled 'Recognition settings' and contains three sub-sections: 'Detection settings' with input fields for area search threshold (30), max width (21), max height (9), min width, and min height; 'Search area border, %' with input fields for left (0), top (0), right (100), and bottom (100); and 'Direction calculation' with a dropdown set to 'by LP position' and a 'Direction' dropdown set to 'any'. There are also checkboxes for 'Cut image with vehicle', 'Allow recognition on demand', 'Undefined', and 'Record violation'. At the bottom left, there are 'Apply' and 'Undo' buttons, with a red circle and the number '2' placed over the 'Apply' button.

2. From the **Country** drop-down list (**1**), select the installed country for license plate recognition.

⚠ Attention!

The **By default** value is available. In this case it will be possible to recognize license plates of all supported countries, though the recognition quality may become worse.

⚠ Attention!

There is a special utility for the **VIT** and **AUTO-Uragan** modules—see [PatCgfr.exe utility for active patterns configuration](#) or [PresetEditor.exe utility for active patterns configuration of VIT module](#)—using which it is possible to set template configurations. Each configuration defines what license patterns will be recognized by the camera. Using various configurations it is possible to set various recognition rules for various cameras.

📘 Note

If the software module supports the two-line license plates recognition, then in order to display them in the *Event Log* in two lines, it is necessary to set the **RemoveNewLine** registry key value to **0** (for details, see [Registry keys reference guide](#), for more information about working with the registry, see [Working with Windows OS registry](#)).

- Click the **Apply** button (2).

5.3.6.3 Selecting the license plate recognition SDK

To select the license plate recognition SDK, do the following:

- Go to the settings panel of the **LPR channel** object representing the activated recognition module.

The screenshot shows the configuration interface for an LPR channel. At the top, there are fields for 'Computer' (LOCALHOST), 'Disable' checkbox, and 'Module' (cmaccr-1.30.dat) with a '1' next to it. Below this are tabs for 'Recognition settings', 'Saving settings', 'Speed camera settings', and 'Settings of LP processing'. The 'Recognition settings' tab is active and contains several sub-sections: 'Detection settings' with input fields for 'Area search threshold' (30), 'Max. width' (21), 'Max. height' (9), 'Min. width', and 'Min. height'; 'Search area border, %' with input fields for 'Left' (0), 'Top' (0), 'Right' (100), and 'Bottom' (100); 'Direction calculation' with a dropdown set to 'by LP position'; and 'Direction' with a dropdown set to 'any'. There are also checkboxes for 'Cut image with vehicle', 'Allow recognition on demand', 'Search area', and 'Show results before vehicle leave'. At the bottom, there are input fields for 'Delay of showing results' (3) and 'Recognition number threshold' (10). The 'Apply' button at the bottom left is marked with a '2'.

- From the **Module** drop-down list (1), select the installed SDK for license plate recognition.

Note

To add the SDK for license plate recognition, it is necessary to download the required SDK from the [AxxonSoft website](#) and install them using the *EngineManager* utility. The procedure of installing the recognition engines using the *EngineManager* utility is described in the *engine_install_windows.txt* file located in the folder with corresponding recognition engine.

If the CARMEN-Auto module is activated, then the **cmnpr-7.2.7.108: general** SDK is used by default for recognizing all the Latin characters of the plates (for example, corresponding to countries such as Argentina, India, Africa and Singapore), although the country recognition function is not used.

The Hazard Identification Number Recognition Engine (ADR) can be added to the list of the countries as a separate "country". The added engine is named **cmnpr- <version number>: latin_eadr** in the list of countries. If it is selected as the country issuing the license plate, the recognition module will be able to identify the license plates of the states using the Latin alphabet, as well as the specialized license plates of vehicles carrying hazard

goods, with detecting and recognizing the type of cargo being transported. The information about the transported cargo will be displayed by the **Vehicle Tracer** object (see [The Vehicle Tracer interface module](#)) in the list of vehicle parameters, and also sent in the event about the recognized number.

Two-line license plates are supported in **CARMEN-Auto** module when the **cmanpr-<version number> : arab** recognizer is selected.

In the Online monitor, the recognized Arabic license plate numbers are always displayed in two lines. The first line begins with the Arabic numbers, and then the Arabic letters are displayed. The second line, by default, begins with the Latin letters, then numbers. To display in the second line the Latin numbers first, and then the letters, it is necessary to set the **VehiclePlateSearch.RightToLeft** registry key value to **0** (for details, see [Registry keys reference guide](#), for more information about working with the registry, see [Working with Windows OS registry](#)).



3. Click the **Apply** button (2).

5.3.7 Setting up the frame sign parameters

If the frame recording to the LP numbers database is activated, digital sign will be automatically assigned to every recorded LP number.

There is a possibility of changing digital sign parameters.

Note

This setting is not available for the following modules: **Remote recognition**, **ARH-Railway**, **ARH-Containers**, **CARMEN-Auto**, **IntLab**.

To set up the parameters of the digital frame sign, do the following:

1. Go to the **LPR channel** object settings panel, corresponding to the activated module (see [Activating the software module used for identifying the plates](#)).

The screenshot shows a configuration window for LPR channel 1. The 'Select cameras' section includes a 'Settings' button (1), 'License plates recognition' (13), 'Synchronous recording' (<none>), 'Auto recording' (10 s), 'Enable on motion detection trigger', and 'Reduce large resolution'. The 'Recognition settings' section includes 'Detection settings' (Area search threshold: 30, Max. width: 21, Max. height: 9, Min. width, Min. height), 'Search area border, %' (Left: 0, Top: 0, Right: 100, Bottom: 100, Search area), and 'Direction calculation' (by LP position, any, Undefined, Record violation). The 'Saving settings' section includes 'Cut image with vehicle' and 'Allow recognition on demand'. The bottom of the window has 'Apply' and 'Undo' buttons (2).

2. Click the **Settings** button (1).
3. The **Frame sign creating** dialog window will be displayed as a result.
4. Add one or several camera installation and speed detector parameters together with LPR channel to a frame sign. Set the **Enabled** checkboxes for necessary parameters in the **SD installation parameters** group and then enter in the field or

select the values of corresponding parameters from the list.

SD installation parameters

SD installation height
 Enabled 5 Installation height in meters **1**

Shooting angle
 Enabled 8 Camera vertical angle **2**

Setting angle
 Enabled 25 Angle between device normal and vehicle movement trajectory **3**

Installation type
 Enabled Bottom side (from t) Installation type **4**

Lane number
 Enabled 1 Number of lane controlled by speed detector **5**

GPS coordinates
 Enabled GPS coordinates GPS coordinates **6**

No	Parameter	Parameter description
1	SD installation height	Speed detector installation height in meters
2	Shooting angle	Angle, made by an camera's lens optical axis and camera's vertical support, in degrees
3	Setting angle	Projection to the horizontal plate of the angle, made by speed detector's normal line and vehicle direction trajectory, in degrees
4	Installation type	Installation type of speed detector
5	Lane number	Lane number, controlled by speed detector
6	GPS coordinates	GPS coordinates of speed detector. Maximum number of characters: 21

5. Add one or several speed detector parameters to the frame sign. Set the **Enabled** checkboxes for necessary parameters in the **Information about SD** group and then enter in the field or select the values of corresponding parameters from the list.

Information about SD

<input checked="" type="checkbox"/> Enabled	<input type="text" value="SD serial number"/>	SD serial number	1
<input checked="" type="checkbox"/> Enabled	<input type="text" value="SD name"/>	SD name	2
<input checked="" type="checkbox"/> Enabled	<input type="text" value="Manufacturer ID"/>	Manufacturer ID	3
<input checked="" type="checkbox"/> Enabled	<input type="text" value="Inspection expiring"/>	YYYYMMDD	4
<input checked="" type="checkbox"/> Enabled	<input type="text" value="Inspection certificate n"/>	Inspection certificate number	5
<input checked="" type="checkbox"/> Enabled	<input type="text" value="Inspection performed t"/>	Inspection performed by	6
<input checked="" type="checkbox"/> Enabled	<input type="text" value="YYYYMMDD"/>	Expiry date of certificate of measuring tools type approval	7
<input checked="" type="checkbox"/> Enabled	<input type="text" value="ID of certificate of mea"/>	ID of certificate of measuring tools type approval	8
<input checked="" type="checkbox"/> Enabled	<input type="text" value="YYYYMMDD"/>	Issue date of certificate of measuring tools type approval	9
<input checked="" type="checkbox"/> Enabled	<input type="text" value="Inspection date"/>	YYYYMMDD	10
<input checked="" type="checkbox"/> Enabled	<input type="text" value="Receiver code"/>	Receiver code	11
<input checked="" type="checkbox"/> Enabled	<input type="text" value="Sender code"/>	Sender code	12

№	Parameter	Parameter description
1	SD serial number	Serial number of speed detector
2	SD name	Speed detector's name
3	Manufacturer ID	Speed detector's manufacturer identifier

№	Parameter	Parameter description
4	Inspection expiring	Date in «YYYY.MM.DD» format, till which the speed detector's metrological check is valid
5	Inspection certificate number	Number of inspection certificate about the last speed detector's metrological check
6	Inspection performed by	Authority, who has performed the last speed detector's metrological check
7	Expiry date of certificate of measuring tools type approval	Date in «YYYY.MM.DD» format, till which the certificate of measuring tools type approval is valid
8	ID of certificate of measuring tools type approval	Number of certificate of measuring tools type approval
9	Issue date of certificate of measuring tools type approval	Date in «YYYY.MM.DD» format when the certificate of measuring tools type approval was issued
10	Inspection date	Date in «YYYY.MM.DD» format of the last speed detector's metrological check
11	Receiver code	Receiver code of the speed detector
12	Sender code	Sender code of the speed detector

6. Add one or several speed detector parameters to the frame sign. Set the **Enabled** checkboxes for necessary parameters in the **Info about SD installation site** and then enter in the field or select the values of corresponding parameters from the

list.

Info about SD installation site

System code name	<input checked="" type="checkbox"/> Enabled	System code name	System code name	1
Unique complex ID	<input checked="" type="checkbox"/> Enabled	Unique complex ID	PHSC ID (Photovideofixation hardware and software complex)	2
Complex name	<input checked="" type="checkbox"/> Enabled	Complex name	PHSC name	3
Complex installation site (short)	<input checked="" type="checkbox"/> Enabled	Complex installation sit	SD installation site (PHSC installation site)	4
Constituents of Russian Federation	<input checked="" type="checkbox"/> Enabled	Altai Krai	Constituents of Russian Federation	5
SD number in complex	<input checked="" type="checkbox"/> Enabled	1	SD code number in complex (PHSC channel)	6
SD installation site in complex	<input checked="" type="checkbox"/> Enabled	SD installation site in c	SD installation site in complex	7
Installation region	<input checked="" type="checkbox"/> Enabled	Installation region	Installation region	8
Settlement	<input checked="" type="checkbox"/> Enabled	Settlement	Settlement	9
Street	<input checked="" type="checkbox"/> Enabled	Street	Street	10
House	<input checked="" type="checkbox"/> Enabled	House	House	11
Vehicle direction at complex installation site	<input checked="" type="checkbox"/> Enabled	Vehicle direction at co	Vehicle direction at complex installation site	12
OKATO-code	<input checked="" type="checkbox"/> Enabled	OKATO-code	OKATO-code	13
Additional info	<input checked="" type="checkbox"/> Enabled	Additional info	Additional text info	14
Controlled direction	<input checked="" type="checkbox"/> Enabled	Oncoming	Traffic flow direction in relation to SD	15
Critical speed threshold	<input checked="" type="checkbox"/> Enabled	10	Additional speed threshold	16
Speed limit at installation site	<input checked="" type="checkbox"/> Enabled	10	Speed limit at SD installation site (Allowed speed)	17

No	Parameter	Parameter description
1	System code name	Photo-video fixation system code-name which contains functioning speed detector
2	Unique complex ID	By default, the identifier of the LPR channel object in <i>Auto Intellect</i> is displayed. If the default value is changed, the string indicated in the field will be displayed
3	Complex name	Complex name
4	Complex installation site (short)	Short description of complex site
5	Constituents of Russian Federation	The constituent member of the Russian Federation where the Speed detector is installed.
6	SD number in complex	Speed detector number in the complex (channel number)
7	SD installation site in complex	Description of speed detector site in the complex
8	Installation region	Region where speed detector is installed
9	Settlement	Settlement where speed detector is installed
10	Street	Street where speed detector is installed
11	House	House near which speed detector is installed
12	Vehicle direction at complex installation site	Vehicle's direction at the complex site
13	OKATO-code	Speed detector site code in All-Russian classifier of administrative territorial division
14	Additional info	Additional information about speed detector
15	Controlled direction	Vehicle's direction in respect of speed detector that controls it
16	Critical speed threshold	Vehicle's speed that is considered to be critical(for example, alarm is being generated in the process)
17	Speed limit at installation site	Allowed vehicle' speed at the road side, controlled by the speed detector

7. Click the **OK** button to save the changes and close the **Frame sign creating** window.

Note

Click the  button to close the window without saving the changes.

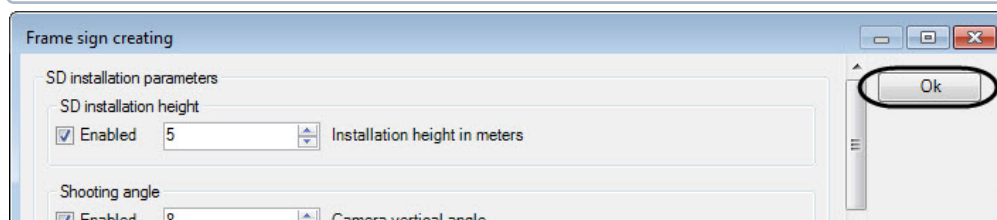

8. Click the **Apply** button (2).

Setting up the digital frame sign is completed.

5.3.8 Setting up the LP recognition results display

The LP numbers of passing vehicles are automatically identified and subsequently shown in the **Vehicle Tracer** interface window. By default, the identified number is displayed after the vehicle leaves the camera viewing zone.

It is possible to display the vehicle number on the screen before the vehicle leaves the frame only if **AUTO-Uragan, CARMEN-Auto, RoadAR** (including the **RoadAR vendor and model recognizer** module) software modules are used.

If the LP number should be shown before the vehicle leaves the viewing zone, do the following:

1. Go to the **Settings of LP processing** tab on the **LPR channel** object settings panel, corresponding to the activated module (see [Activating the program module, used for identifying the plates](#)).

2. Set the **Display result before vehicle leaves** checkbox (1) to show the result before the car actually leaves the viewing zone (more precisely, before the license plate leaves the recognition zone). If the checkbox is not set, the result will be shown only after the car actually leaves the zone.
3. In the **Result display delay** field (2), specify the time in seconds, after which the recognition result will be displayed. This period of time starts after the first LP recognition.

Note

This parameter is enabled if the **Display result before vehicle leaves** checkbox is set.

4. In the **Recognition number threshold** field (3), specify the number of reliable license plate recognitions, upon reaching which the recognition result will be displayed. The recognition number counter is cumulative and is not reset in case of temporary loss of a given zone or false recognitions.

Note

This parameter is enabled if the **Display result before vehicle leaves** checkbox is set.

5. Click the **Apply** button (4).

Note

If both **Result display delay** and **Recognition number threshold** fields are set, the results will be shown upon the event that occurs first (either the **Result display delay** time elapses, or the **Recognition number threshold** is reached). If the values of these parameters are set to **0** or not set at all, then the parameters **Result display delay** and **Recognition number threshold** are not taken into account, and the LP recognition results will be shown after the vehicle leaves the viewing zone.

Note

Display result before vehicle leaves, Result display delay and **Recognition number threshold** parameters do not work with the **Parking mode**.

The LP recognition results display is set up.

5.3.9 Setting the joint operation of the LPR channel and the motion detector of the Intellect platform

The LPR channel can operate together with the main motion detector of *Intellect*. This helps decrease the CPU load.

Note

This setting is set only when using the following program modules: **AUTO-Uragan, CARMEN-Auto, ARH-Railway, VIT, or LPR IntelliVision**.

If the LPR channel works in conjunction with the *Intellect* main motion detector, it scans the video image for LP numbers when the motion detector is in an alarmed state, i.e. some motion is detected in the camera FOV.

Note

When the main motion detector is not alarmed, the LPR channel does not scan the video image to find and recognize the LP numbers.

If the joint operation is disabled, the LPR channel scans each incoming frame.

To enable joint operation of the LPR channel and the *Intellect* motion detector, do the following:

1. Go to the **LPR channel** object settings panel, corresponding to the activated module (see [Activating the software module used for identifying the plates](#)).

2. Check the **Enable on motion detection trigger** checkbox (1).
3. Click the **Apply** button (2).

The joint operation of the **LPR channel** and the *Intellect* motion detector is now completed.

5.3.10 Selecting the traffic direction for LP number recognition

By default, the **LPR channel** recognizes the LP numbers of all vehicles passing the camera viewing zone: i.e. moving toward the camera and away from the camera. The module can be set to recognize and save the LP numbers of the vehicles moving in certain direction: **From the camera, To the camera, Any**. The following results can appear as an outcome of the vehicle movement direction recognition: **From the camera, To the camera, undefined**.

If traffic direction is set, then by default in case if the direction of vehicle movement does not coincide with the specified value, the **Entered the oncoming lane** alarm event will be created. This event can be disabled. If vehicle movement direction is undefined, the **Entered the oncoming lane** alarm event is not created.

Attention!

The availability of the parameters depends on the activated software module (for details, see [The LPR channel object settings panel](#)).

To select the movement direction for the vehicles to be recognized, do the following:

- Go to the **LPR channel** object settings panel, corresponding to the activated module (see [Activating the software module used for identifying the plates](#)).

- From the **Direction calculation** drop-down list (1), select the mode of determining the vehicle's movement direction:
 - by LP position** - the direction is determined by the position of the upper part of the LP number. If the upper part of the LP number at the start of tracking is lower than the upper part of the LP number at the end of tracking, then the direction is defined as **From the camera**, otherwise - **To the camera**.
 - by LP area** - the direction is determined by the license plate area. If the LP area at the start of tracking is larger than the LP area at the end of tracking, then the direction is defined as **From the camera**, otherwise - **To the camera**.
 - by SDK** - the direction is determined by the SDK. Currently, the following LP recognition modules support this mode: **RoadAR, VIT, AUTO-Uragan, LPR IntelliVision**.

Note

If the direction of movement is detected incorrectly or the license plate recognition stops, it is recommended to select the **by LP area** mode.

- From the **Direction** drop-down list (2), select the traffic direction relative to the camera in which it is necessary to recognize the LP numbers.

Note

For the **IntLab, RIDR IntelliVision** and **CIDR IntelliVision** modules, the direction of carriages in the camera view is selected from left to right or from right to left.

- Set the **Undefined** checkbox (3) to display the direction as **Undefined** in the **Vehicle Tracer** module, if it is impossible to determine the vehicle direction.

5. If the **from the camera** or **to the camera** value is selected in the **Direction** drop-down list, the **Record violation** checkbox becomes available (4). By default this checkbox is set. That means that in case if the direction of vehicle moving is not coincide with the specified value, the **Entering an oncoming lane** alarm event will be created. If this event should not be created, unset the checkbox.

Note.

The following variations are possible depending on selecting the traffic direction:

- if the **to the camera** direction is selected and the **Record violation** checkbox is set the recognition is performed in both direction; if traffic is performed from the camera the alarm event will be created;
- if the **from the camera** direction is selected and the **Record violation** checkbox is set the recognition is performed in both direction; if traffic is performed to the camera the alarm event will be created;
- if the **to the camera** direction is selected and the **Record violation** checkbox is not set the recognition is performed only in direction to the camera;
- if the **from the camera** direction is selected and the **Record violation** checkbox is not set the recognition is performed only in direction from the camera;

6. Click **Apply (5)**.

The vehicle movement direction is now selected.

5.3.11 Setting up the results filtering

It is possible to configure the filtering of the recognized LP numbers according to a number of criteria.

Note

By default, the recognized numbers that have been filtered are not saved in the database. In order for the filtered numbers to be saved in the database, it is necessary to set the **0** value for the **SaveFilterToDB** parameter (for details, see [Registry keys reference guide](#), for more information about working with the registry, see [Working with Windows OS registry](#)).

To configure the filtering of the vehicle plates, do the following:

1. Go to the **LPR channel** object settings panel, corresponding to the activated module (see [Activating the software module used for identifying the plates](#)).

2. Go to the **Saving settings** tab (1).
3. In the **Min. number of characters in LP** field (2), specify the minimum number of characters in the recognized number.
4. In the **Min. recognition quality, %** field (3), specify the minimum recognition quality in percent.
5. In the **Min. time of LP repetition, s** field (4), specify the minimum time in seconds of number repetition in the video in the range 0-3600.
6. Click the **Apply** button (5) to save the settings.

Setting up the filtering of the recognized LP numbers is completed.

5.3.12 Frame processing setup

Half-frame processing should be performed using the image interlaced scanning (the **Reduce large resolution** checkbox is set). If the half-frame processing is enabled, when the next frame is received, a new frame is created and processed, consisting only of the even rows of the initial frame. By default, the LPR channel processes the half-frame.

When the full resolution is used, a half-frame shouldn't be processed, and the **Reduce large resolution** checkbox should be clear.

Note

Frame processing settings are set only when using the following program modules: **AUTO-Uragan, CARMEN-Auto, ARH-Railway, VIT, IntLab, LPR IntelliVision**.

To set the frame processing, do the following:

1. Go to the **LPR channel** object settings panel, corresponding to the activated module (see [Activating the program module, used for identifying the plates](#)).

2. Set the **Reduce large resolution** checkbox (1).

Note

It is recommended to always set the **Reduce large resolution** checkbox in order to decrease the CPU load.

3. Click the **Apply** button (2).

The frame processing setup is now complete.

5.3.13 Configuring speed estimation by video

The **AUTO-Uragan**, **CARMEN-Auto**, **RoadAR** and **VIT** recognition modules enable estimating vehicle speed by video via the *Auto Intellect* algorithm. The results are displayed over video image as captions.

Note

The **RoadAR** module also allows video speed estimation using a proprietary algorithm. The speed estimation by video for the **RoadAR** recognition module is configured on its settings panel (see [Configuring the RoadAR software module](#)). If speed estimation by video is enabled on both the settings panel of the **LPR channel** and on the settings panel of the **RoadAR** object, then speed will be estimated using the *Auto Intellect* algorithm.

To configure speed estimation by video, do the following:

1. Go to the **LPR channel** object settings panel, corresponding to the activated module (see [Activating the software module used for identifying the plates](#)).

2. Go to the **Speed camera settings** tab (1).
3. Set the **Get speed from video** checkbox (2). As a result, settings for speed estimation become available.

4. Click the **Configuration** button (3). The **Get speed from video** dialog box opens.

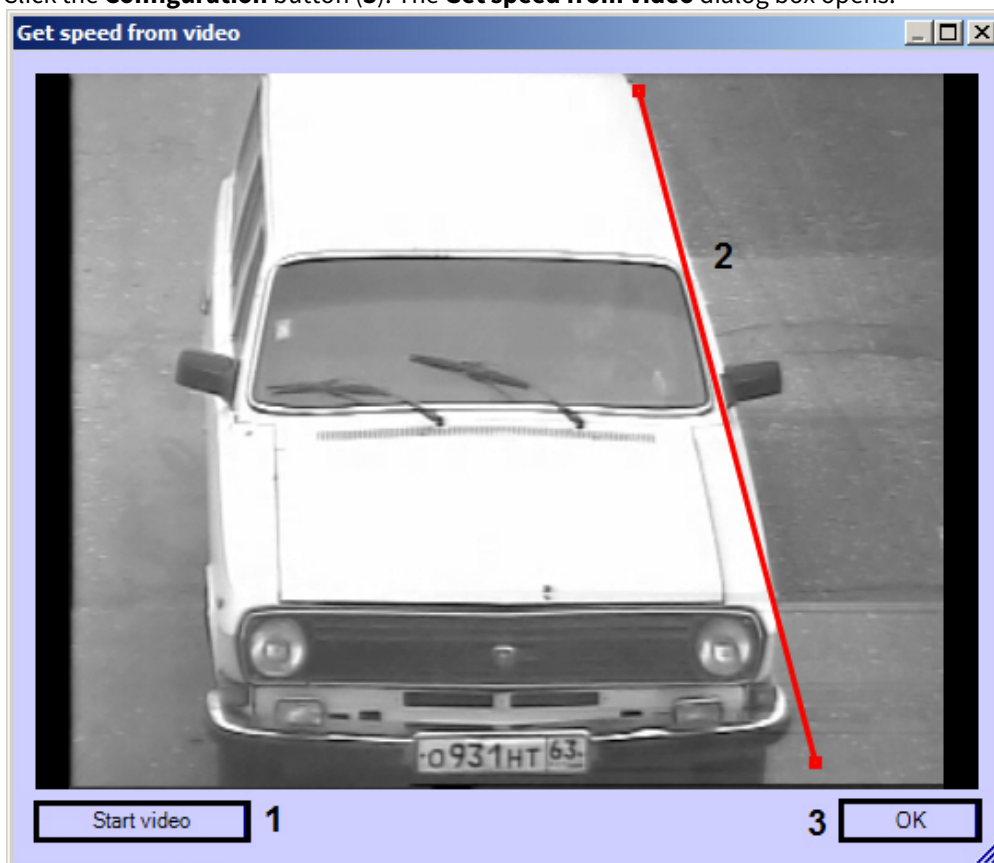

- a. Click **Start video** (1).
 - b. Add a line segment of a known length in centimeters to the video image (2).
 - c. Click **OK** (3).
5. In the **Distance** field, enter the length of the previously specified line segment in centimeters (4).
 6. Enter permitted vehicle speed in the **Permitted speed** field (5).
 7. Enter maximum vehicle speed in the **Alarm on speed limit** field. If this speed is exceeded, an alarm event is generated (6).
 8. Click **Apply** (7).

Configuring speed estimation by video is completed.

5.3.14 Settings of LP processing

Settings of LP processing include the following functionality:

1. Automatic transcoding of Latin characters into Cyrillic, if the license plate recognition module returns recognized numbers in Latin characters (for example, **LPR IntelliVision, RoadAR**).
2. Ignoring numbers that are contained in the predefined list of rules. Rules can contain either an exact number or a regular expression. This allows, for example, to ignore the LP numbers of a certain region.
3. Ignoring repeated license plate recognition.

LP processing is configured in the following way:

1. On the **LPR channel** object settings panel, go to the **Settings of LP processing** tab (1).

The screenshot shows the 'Settings of LP processing' tab for 'LPR channel 2'. Key elements include:

- Channel Info:** Channel name 'LPR channel 2', Computer 'LOCALHOST', Country 'Russia'.
- Recognition Settings:** Select cameras 'itv1', License plates recognition 'Synchronous recording', Auto recording '10 s', Enable on motion detection trigger, Reduce large resolution.
- LP Processing Settings:** Skip repeated recognitions, s: '0'; Display result before vehicle leaves: checked; Result display delay: '3'; Recognition number threshold: '10'.
- Character Transcoding:** A checkbox labeled '2' for 'Character transcoding (Latin->Cyrillic)'.
- Skipped LPs:** A list containing '.555.+'
- Input/Check:** An 'Enter LP:' field with a 'Check' button.

2. To enable automatic transcoding of Latin characters into Cyrillic, set the **Character transcoding (Latin->Cyrillic)** checkbox (2).
3. If it is necessary to ignore repeated license plate recognition, in the **Skip repeated recognitions, s** field, enter the time period in seconds greater than 0, during which the captured license plate should not be recognized again (3).

Note

The value of the **Skip repeated recognitions, s** field has a limit of 86400 seconds (number of seconds in a day).

4. To configure the ignoring of numbers according to the list of rules, do the following:
 - a. Right-click on the **Skipped LPs** field, and then click the **Add** button (4).

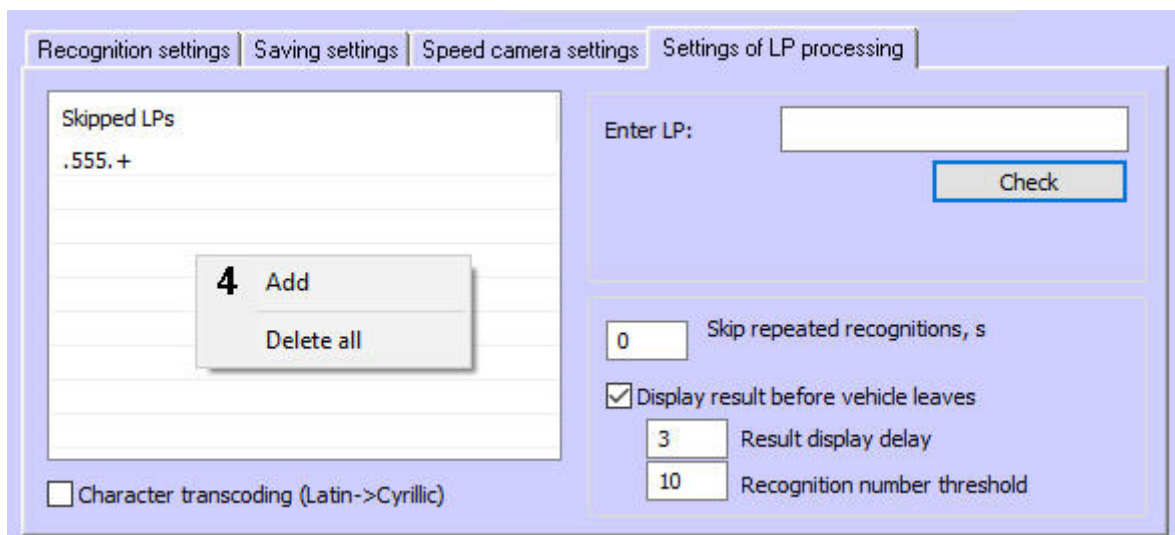

- b. Enter the required rule using regular expressions (5). A rule can contain either an exact number or a regular expression.

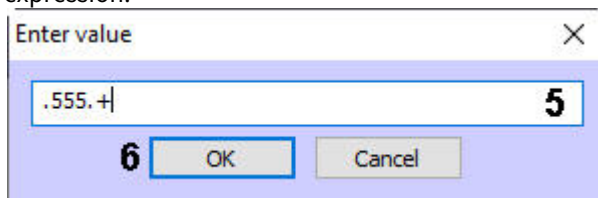

Note

For example, the regular expression ".555.+" means that there can be only one arbitrary character before "555", and many arbitrary characters after "555".

- c. Click **OK** (6).
- d. To edit or delete an already added rule, right-click on it and select the appropriate action by clicking **Edit** (7) or **Delete** (8). The **Delete all** button (9) is used to delete all rules.

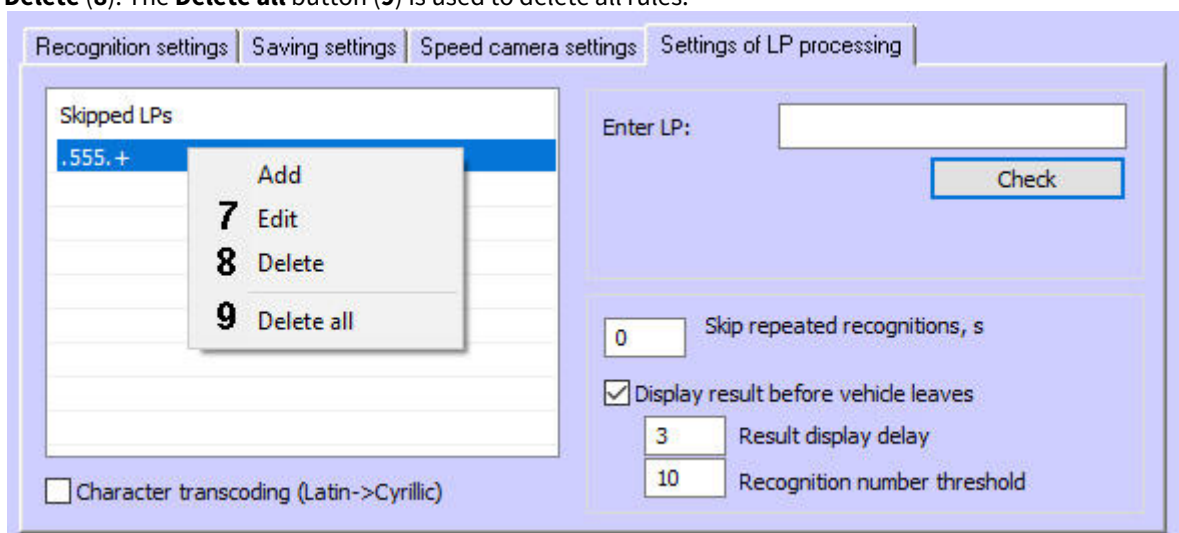

- e. You can check if the specified rule is correct. To do this, enter the test LP in the **Enter LP** field (10) and click **Check** (11). The result will appear below in the field (12).

Note

The maximum number of characters in the **Enter LP** field is 30.

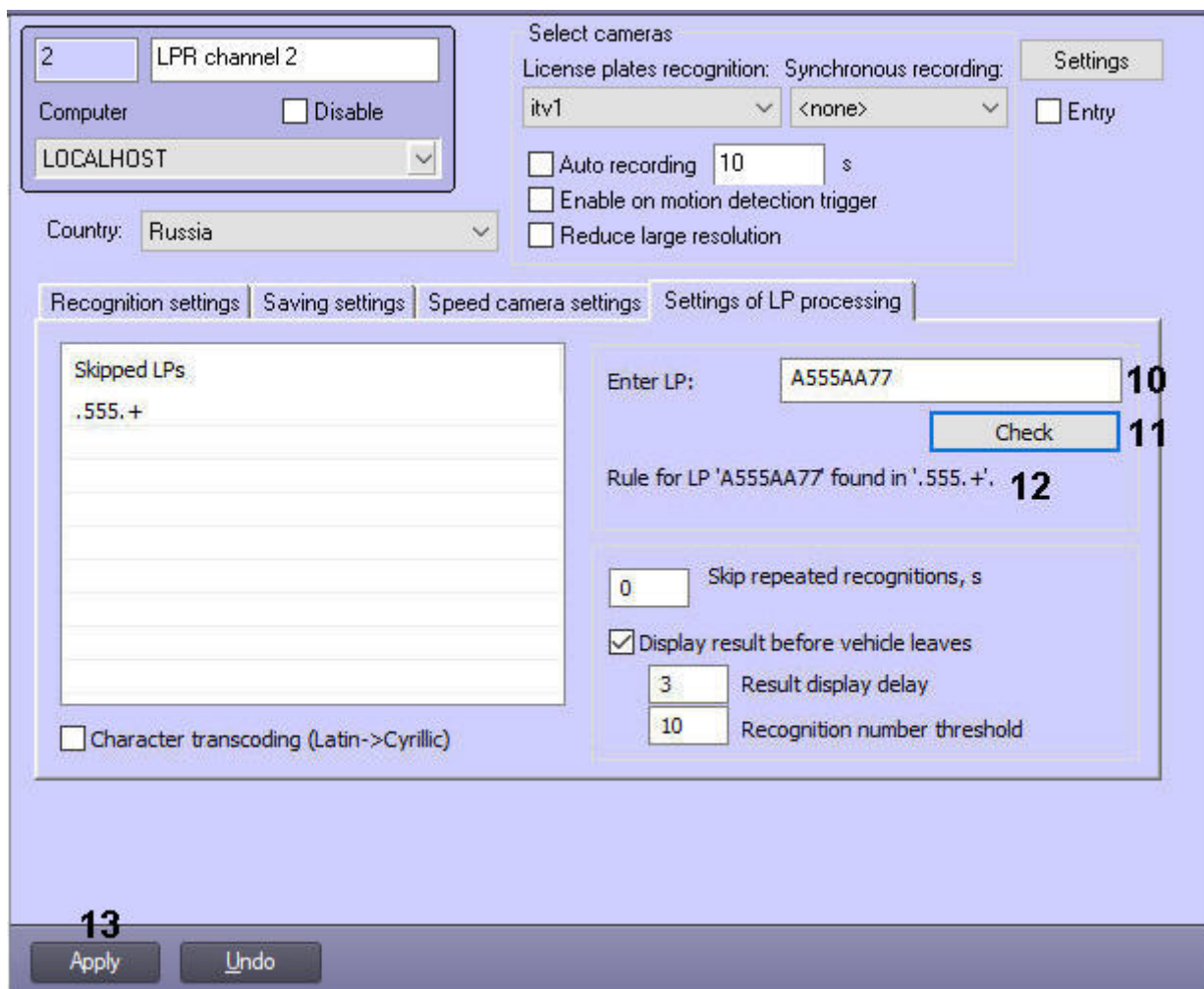

5. Click **Apply** (13).

The LP processing is now set up.

5.4 Setting up the joint operation of Auto Intellect and Axxon Next

The *Auto Intellect* software package and the *Axxon Next* software package can operate together. The joint operation allows to:

- Receive the video from the *Axxon Next* cameras for further license plate recognition using the *Auto Intellect* license plate recognition modules.
- Receive the events about the license plate recognition as from an external recognizer.

⚠ Attention!

Auto Intellect and *Axxon Next* should be located on the same Server.

Set up the joint operation of *Auto Intellect* and *Axxon Next* as follows:

1. Enable the joint operation of *Intellect* and *Axxon Next*. To do this, set the **1** value for the **NgpMode** registry key (see [Registry keys reference guide](#), for details about working with the registry, see [Working with Windows OS registry](#)). It is also necessary to make sure that the port for connecting to *Axxon Next* specified in the **An.port** registry key is **20111**.

📘 Note

Once the joint operation of Intellect and Axxon Next is enabled, the creation of **Video Capture Device** objects becomes unavailable.

2. Create and configure the **NGP manager** module for connecting to *Axxon Next* (see the details on configuration of this module in the *Intellect* Administrator's Guide, the most current version of the documentation is located in the [AxxonSoft documentation repository](#)). As a result, the objects of the corresponding *Axxon Next* cameras will be automatically created in *Intellect*.

Note

To ensure the correct connection, *Axxon Next* should be launched with administrator rights.

3. If it is necessary to recognize the license plates using the *Auto Intellect* license plate recognition module, then *Auto Intellect* should be configured in a standard way, and the appropriate *Axxon Next* camera should be selected on the settings panel of the **LPR channel** object (see [Selecting the video cameras to work with the LPR channel](#)).
4. If the license plates are recognized on the *Axxon Next* side, then in order to receive the license plate recognition events as from an external recognizer, it is necessary to activate the **Remote recognition** module.
5. To view the video archive by the event from the video camera which is used for the license plate recognition, select **AxxonNext monitor** on the settings panel of the **Vehicle Tracer** object (see [Selecting the Monitor object for playing back the video archive](#)).

Setting up the joint operation of *Auto Intellect* and *Axxon Next* is now complete.

5.5 The Traffic Monitor interface object setup

5.5.1 The Traffic Monitor setup procedure

The **Traffic Monitor** object setup includes the following steps:

1. Open the **Interfaces** tab in the **System Settings** window;
2. Select the **Traffic Monitor** object in the object tree;
3. Edit the parameter value;
4. Click **Apply** to save the changes.

5.5.2 Setting up the position of the Traffic Monitor window

The **Traffic Monitor** position in the screen is specified using the coordinates of its upper left corner, its width and height, and the possibility to move the window around the screen using the mouse.

To set the **Traffic Monitor** window position, do the following:

1. Open the **Interfaces** tab in the **System Settings** window (1).
2. Select the **Traffic Monitor** object in the object tree (2).
3. By default, the **Traffic Monitor** window is located in the middle of the screen, with the following upper left corner coordinates: X = 10, Y = 10. To change its position, enter the coordinates in the X and Y fields, as a percentage of the screen width and height, respectively (3).

4. By default, the **Traffic Monitor** window takes 64% screen space (80% of the width and height of the screen). To change the window size, enter the values in the W and H fields, as a percentage of the screen width and height, respectively (4).

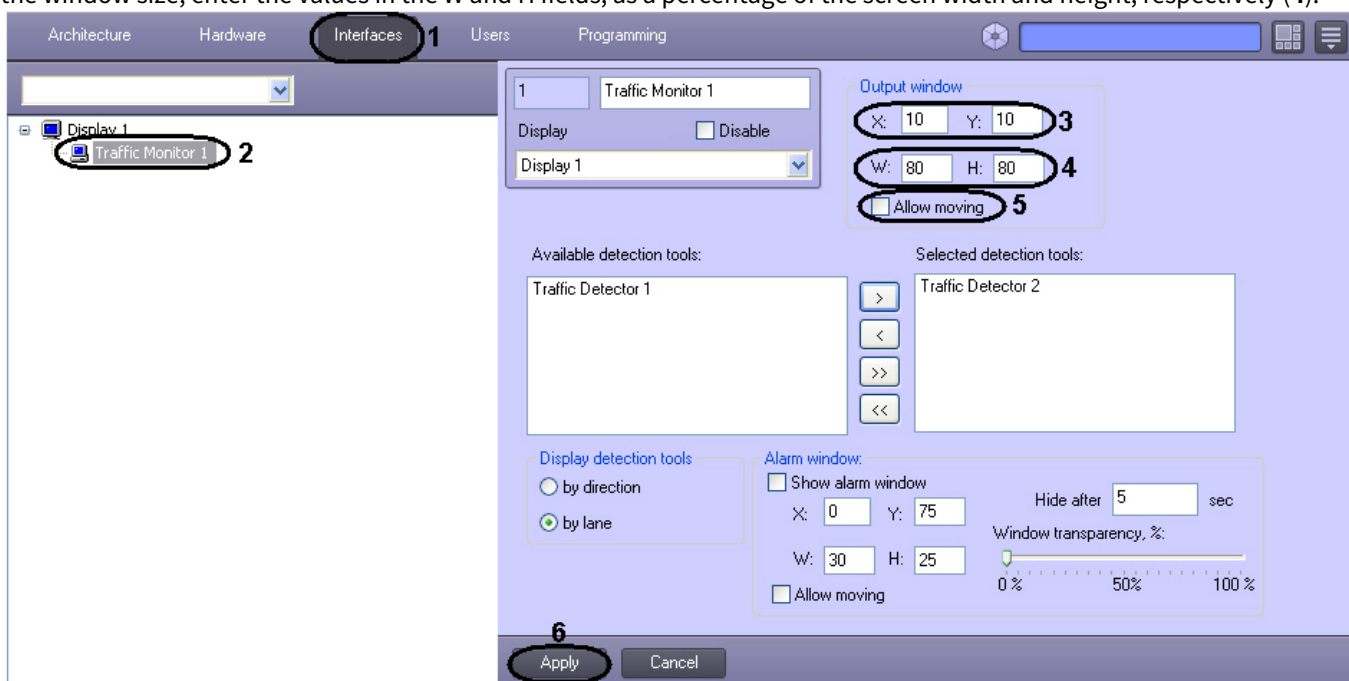

5. By default, the **Traffic Monitor** window cannot be freely moved around the screen. To allow free movement of the window, check the **Allow moving** checkbox (5).
6. Click **Apply** (6).

The **Traffic Monitor** window position and dimensions are now set.

5.5.3 Selecting the traffic detectors to be connected to the Traffic Monitor object

To select the traffic detectors, do the following:

1. Open the **Interfaces** tab in the **System Settings** window (1).
2. Select the **Traffic Monitor** object in the object tree (2).
3. Select an item in the **Available detection tools** list (3).

4. Click the  button to move the selected item to the **Selected detection tools list (4-5)**.

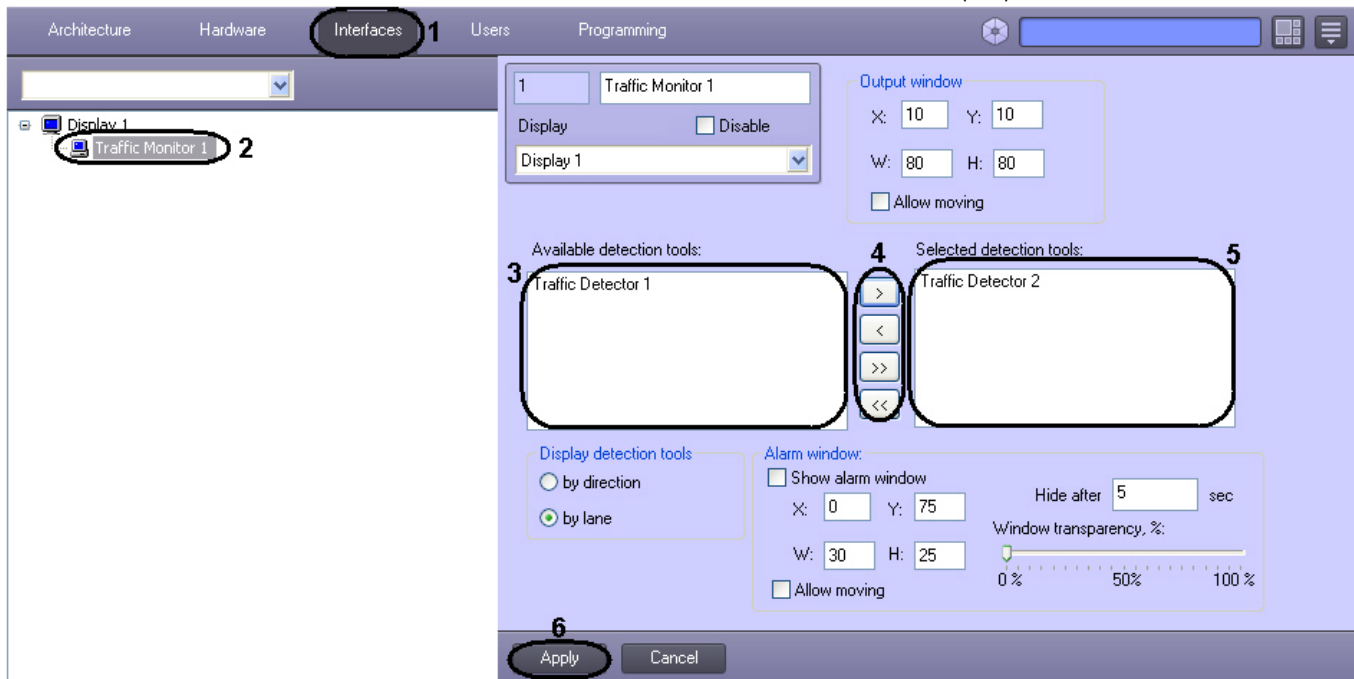

5. Click **Apply** to save the changes (6).

The traffic detectors are now selected.

5.5.4 Setting up the traffic information display option

To select the traffic information display option, do the following:

1. Open the **Interfaces** tab in the **System Settings** window (1).
2. Select the **Traffic Monitor** object in the object tree (2).
3. Select one of the radio-buttons in the **Display detection tools** group - by direction, or by lane (3).

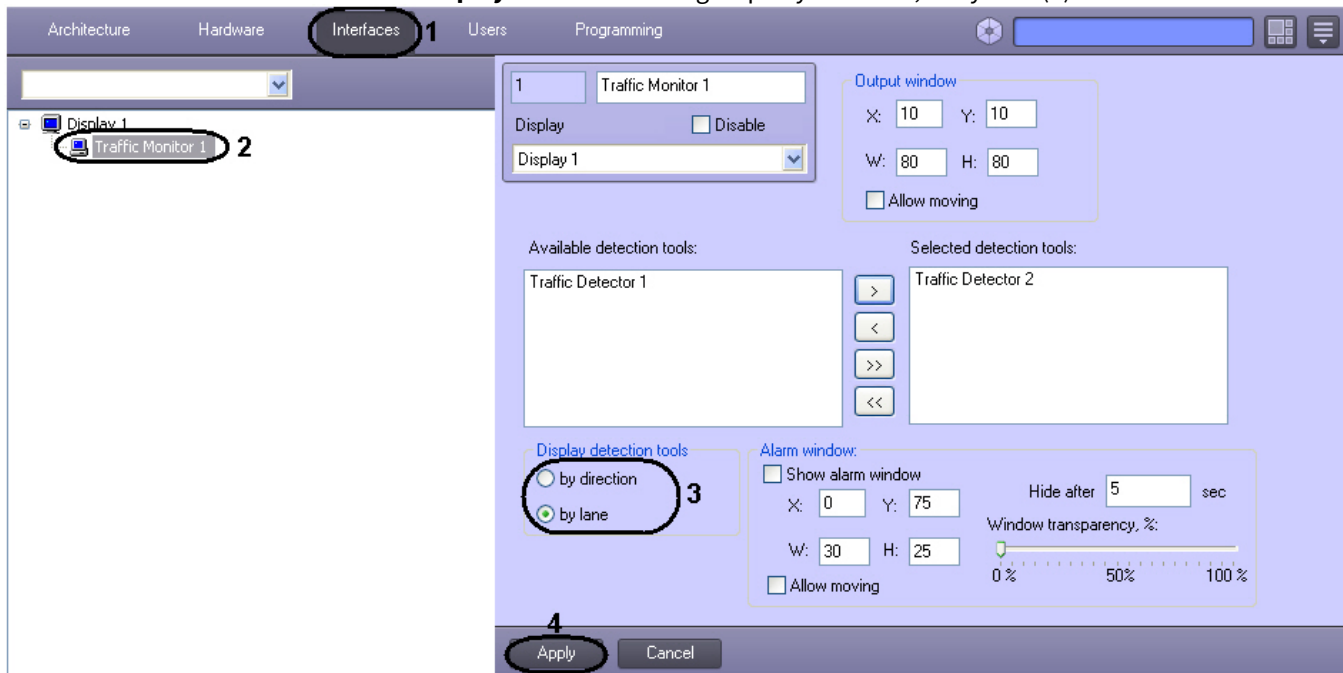

4. Click **Apply** to save the settings (4).

The information display option is now selected.

5.5.5 Setting up the Alarm window position

To set up the **Alarm window** position, do the following:

1. Open the **Interfaces** tab in the **System Settings** window (1).
2. Select the **Traffic Monitor** object in the object tree (2).
3. By default, the **Alarm window** is not displayed. To open the **Alarm window**, check the **Show alarm window** checkbox (3).
4. To change the window position, enter the values in the **X** and **Y** fields (4). The values must correspond to the coordinates of the upper left corner of the window as a percentage of the screen width and height, respectively.
5. To change the window size, enter its width in the **W** field and its height in the **H** field as a percentage of the screen dimensions (5).
6. By default, the **Alarm window** cannot be moved around the screen. To enable window movement, check the **Allow moving** checkbox (6).
7. In the **Hide after** field, enter the number of seconds that the window will be displayed until it is closed (7).
8. Set the **Alarm window** transparency level using the Window transparency slider. By default, the **Window transparency** window is displayed opaque (minimum transparency). The transparency level increases (in percent) when the slider is moved to the right (8).

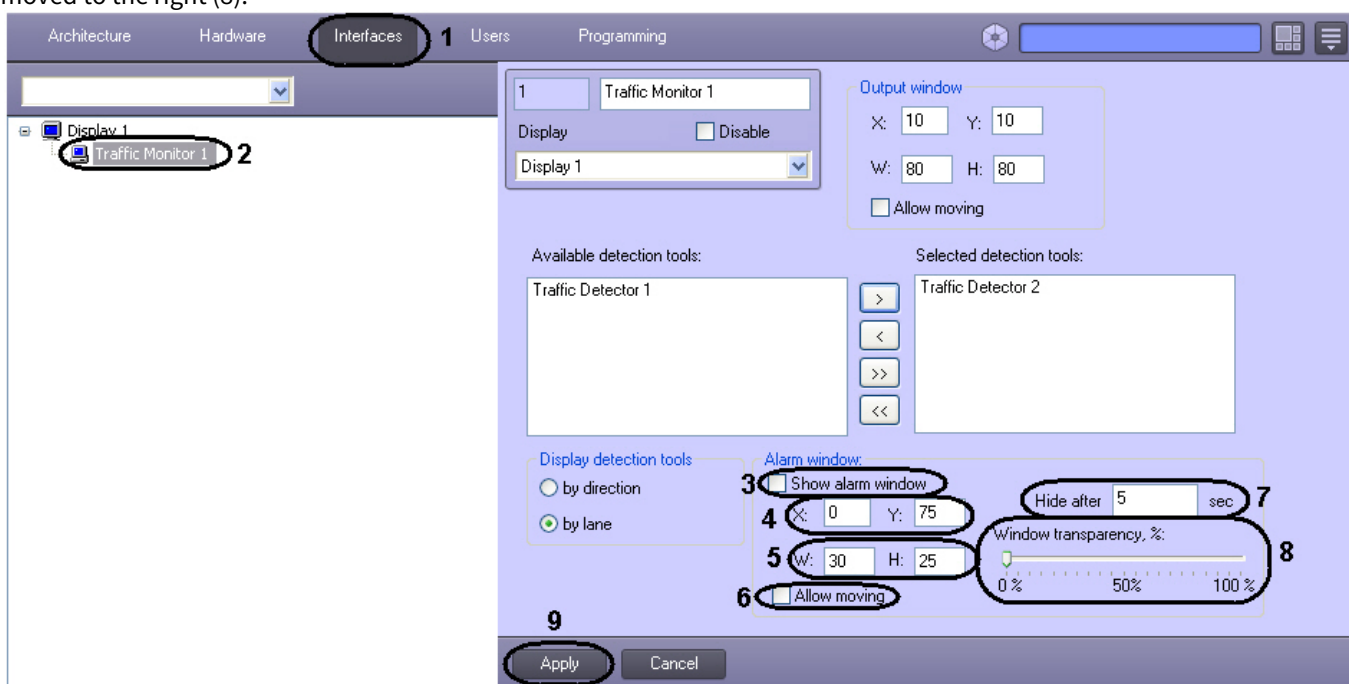

9. Click **Apply** (9).

The **Alarm window** position is now set.

Note. If the text in the **Alarm window** overlaps the images, enlarge the window (see step 5) to the size when the text and images are displayed correctly.

5.6 The Vehicle Tracer interface module

5.6.1 The Vehicle Tracer functionality

The **Vehicle Tracer** module is designed for identifying vehicles that are on the wanted list or overspeeding. Identifying is performed in real time.

Note.

The module is the **Vehicle Tracer** interface object (see [Setting up the Vehicle Tracer interface window](#) section).

The **Vehicle Tracer** module supports the following functionality:

1. displaying the plates that are in identifying detectors' view;
2. displaying vehicles' speed;
3. registering vehicle 's overspeeding with controlled voice notification of the operator;
4. registering the plate identification in the external database (for example in the search base) with controlled voice notification of the operator;
5. alarm handling;
6. search events in the *Auto-Intellect* recognizers database.

5.6.2 The Vehicle Tracer setup procedure

Setting up the **Vehicle Tracer** is performed on ht settings panel of the similarly-named object. The object is created on the basis of Screen object in the **Interfaces** tab of the **System settings** dialog window.

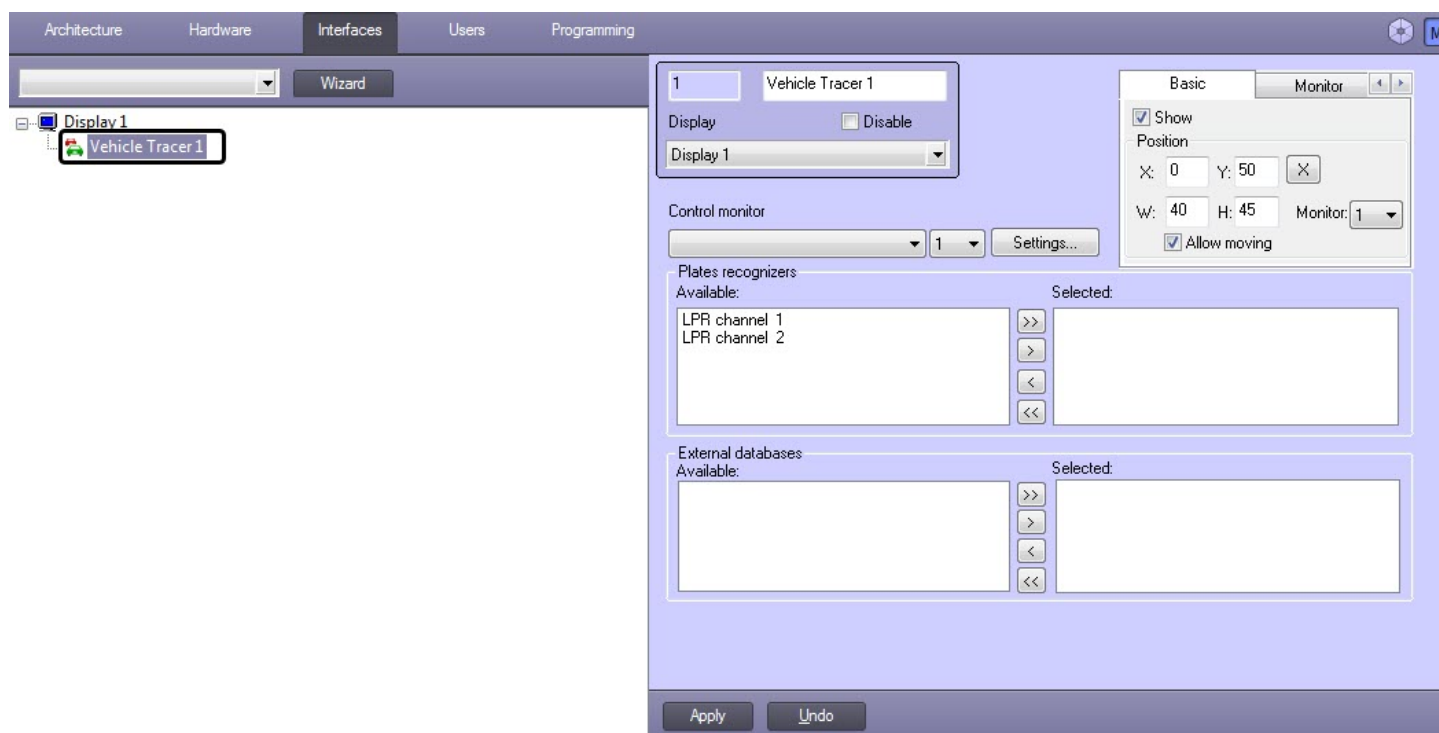

Setting up the **Vehicle Tracer** interface window is used in the following name:

1. Set up the **Vehicle Tracer** window position on the screen.
2. Select the plates recognizers servers to be displayed in the **Vehicle Tracer** window
3. Select the **External databases** to analyze the identified plates.
4. Set up the interface of the **Vehicle Tracer** window.
5. Set up the voice notification with overspeeding and/or identifying the plate in the external plates database.
6. Select the **Monitor** interface object for displaying the video archive from the camera, identifying the plates.

5.6.3 Setting up the position of the Vehicle Tracer components on the screen

The **Vehicle Tracer** interface window includes the following components:

1. **Active monitor** – is designed for displaying the data about the identified plates, processing the alarm;
2. **Events monitor** – displays a video frame with a vehicle, which plate is being identified at the moment, and also a speed and a number.

3. **Alarm window** - is designed for displaying the data about vehicles in case of coincidence of recognized plates with plates which are stored on the external orientation database.

Note.

The **Events monitor** and the **Alarm window** components are optional.

To set up the **Vehicle Tracer** components position on the screen, do the following:

1. Go to the **Vehicle Tracer** settings panel.

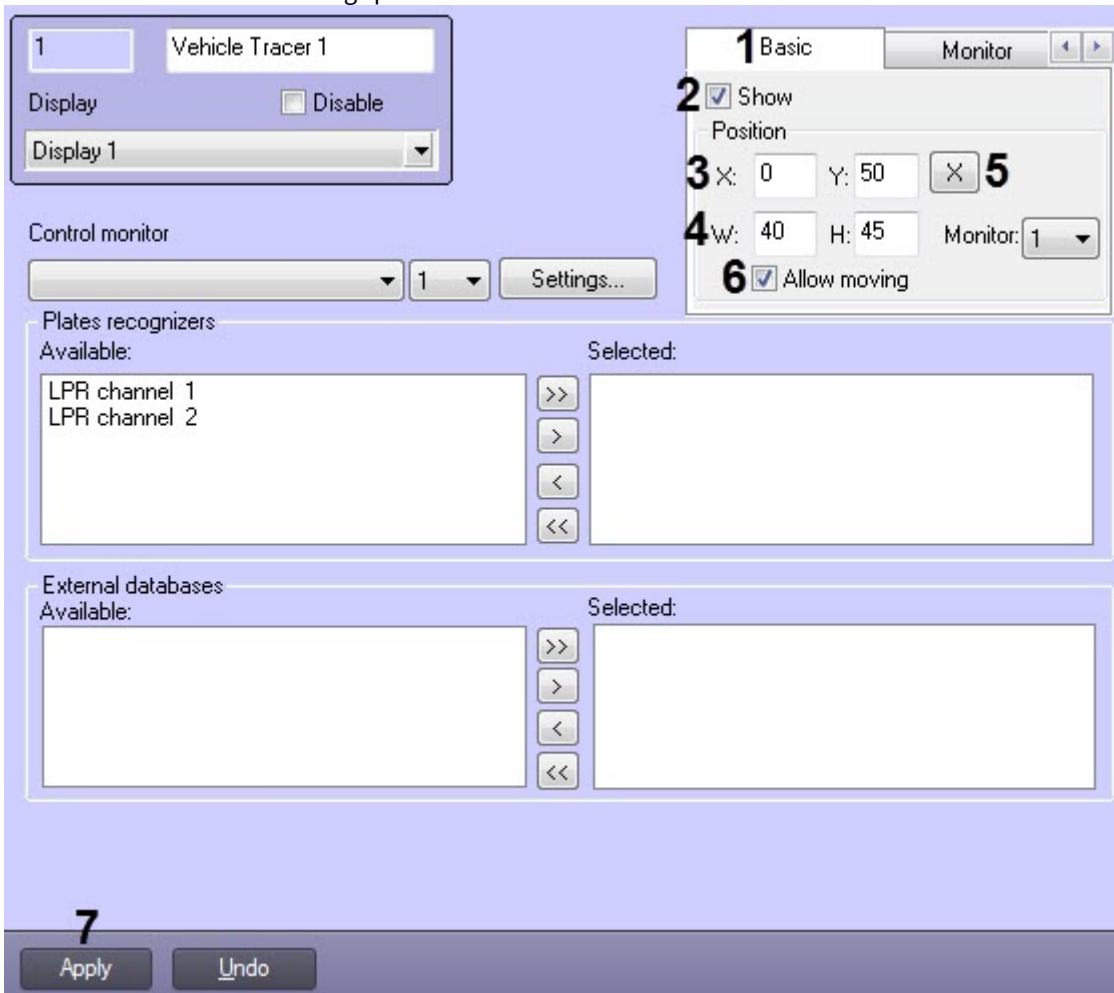

2. Select the required tab of the corresponding **Vehicle Tracer** component (1):
- **Basic** tab - corresponds to the **Active monitor** component.
 - **Monitor** tab - corresponds to the **Events monitor** component.
 - **Alarm window** tab - corresponds to the **Alarm window** component.
3. Set the **Show** checkbox (2) if it is necessary to display the selected component on the screen.
4. Set the coordinates of the left upper corner of the selected component (3):
- Field **X** (horizontal indent from the left border of the computer's screen).
 - Field **Y** (vertical indent from the upper border of the computer's screen).

Note

The coordinates are set in percentage in according to screen's size horizontally and vertically respectively.

5. Set the sizes of the selected component on the screen (4):
- Field **W** (component's width)
 - Field **H** (component's height).

Notes

- The coordinates are set in percentage in according to screen's size horizontally and vertically respectively.
- Minimum sizes of the **Active monitor** component are 70% horizontally (**W**) and 39% vertically (**H**).
- To ensure the Operator's efficiency, avoid the mutual overlapping of components.
- To set the coordinates and sizes of the selected component in a convenient way, it is recommended to use the visual method of setting up the coordinates. Click  button for this (5) and, using the mouse, set the required size and position of the test window and then click **OK**. Coordinates of the test window are automatically calculated and copied to the fields **X**, **Y**, **W** and **H**.



6. Set the **Allow moving** checkbox (6) if it is necessary to allow moving the component across the screen.
7. From the Monitor drop-down list, select the number of the physical monitor connected to the computer on which the selected component should be displayed.
8. Click **Apply** to save the changes (7).



Setting up the position of the **Vehicle Tracer** components on the screen is complete.

5.6.4 LPR channels selection

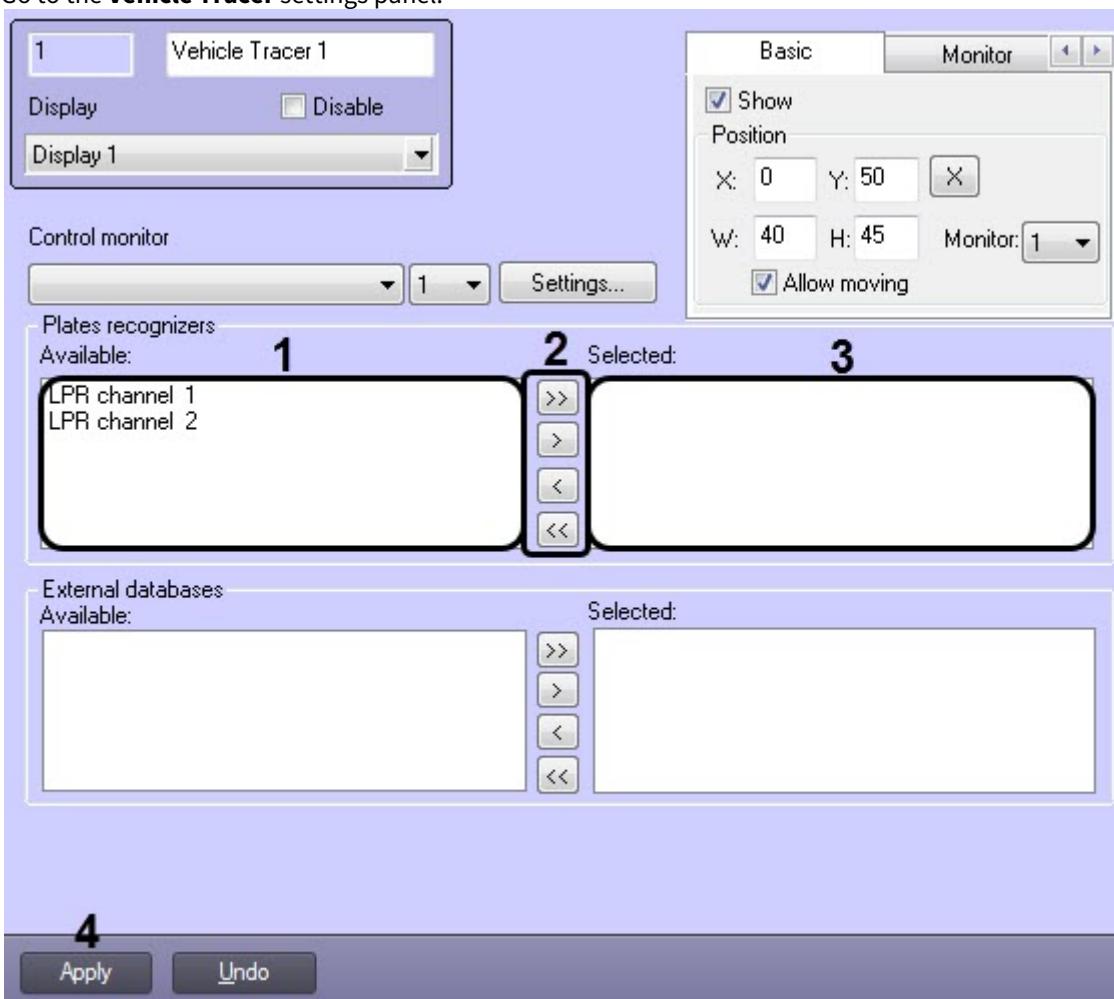

Select the LPR channels, the information from which will be displayed in the **Vehicle Tracer** interface window, as follows:

1. Go to the **Vehicle Tracer** settings panel.



2. From the **Available** list of the **Plates recognizers** group (1), select the required LPR channel.
3. Move the selected LPR channel to the **Selected** list (3) using the  button (or  button (2) for moving all the LPR channels from the list).

Note.

Buttons  and  are used for moving the selected or all the LPR channels from the **Selected** list back to the **Available** list.

4. Click **Apply** to save the changes (4).



Selecting the LPR channels is completed.

5.6.5 Selecting the External Plates Database

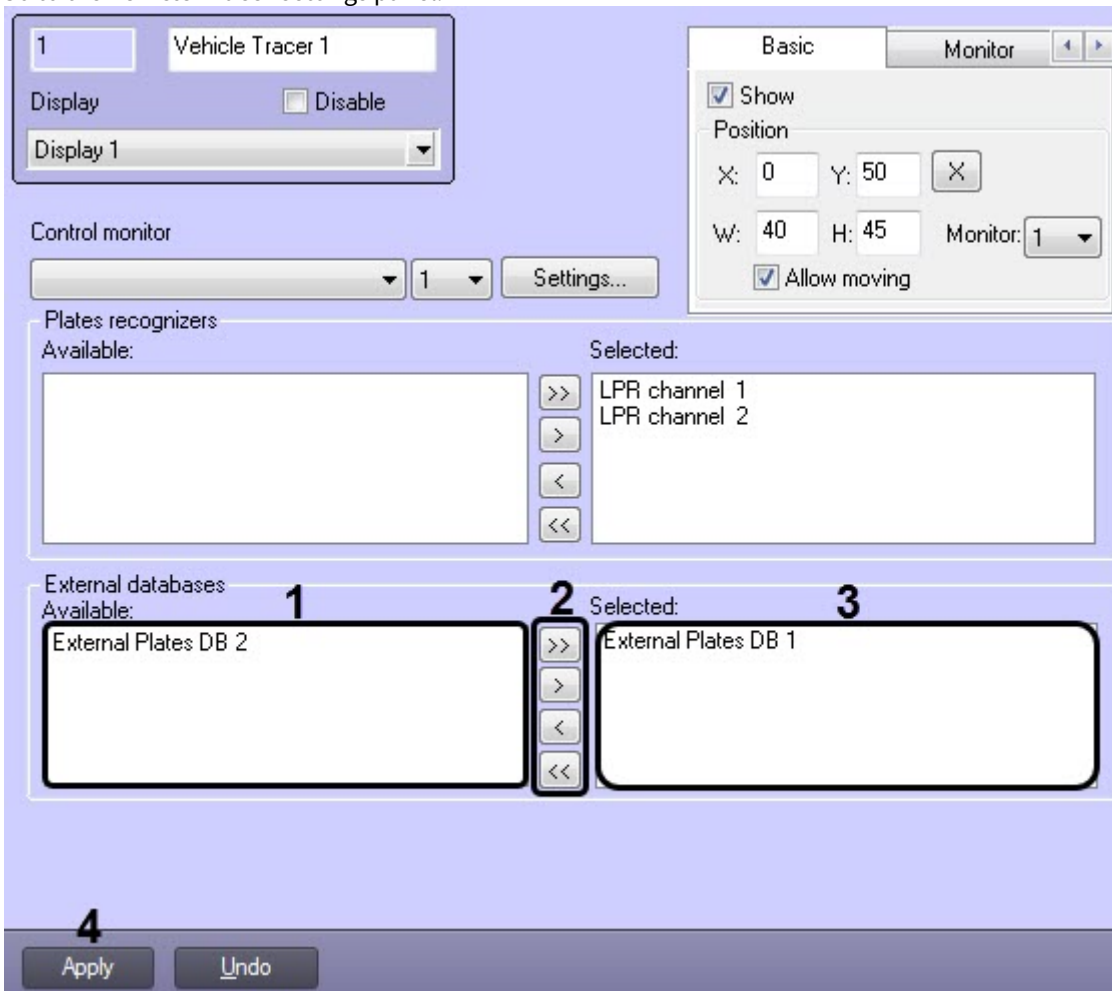

Selecting the **External Plates Database** to analyze the identified plate's window is done in the following way:

1. Go to the **Vehicle Tracer** settings panel.



2. From the **Available** list of the **External databases** group (1), select the required external plates databases.
3. Move the selected external plates databases to the **Selected** list (3) using the  button (or  button (2) for moving all the external plates databases from the list).

Note.

Buttons  and  are used for moving the selected or all the external plates databases from the **Selected** list back to the **Available** list.

4. Click **Apply** to save the changes (4).

Selecting the External Plates Database to analyze the identified plates is completed.

5.6.6 Setting up the Vehicle Tracer interface window

To set up the **Vehicle Tracer** interface window, do the following:

1. Go to the **Vehicle Tracer** settings panel. Click the **Settings** button. The **Settings** dialog window will open.

2. In the **Number of events in protocol** field (1), enter the maximum number of events from 10 to 10000 that can be displayed in every protocol of the **Active Monitor** component. The update of the protocol which contains the maximum number of events, is performed in a loop: when the maximum number of events is exceeded, the last event in the queue is deleted.

Note

This entails two protocols:

- a. The protocol of identified vehicles, containing data about the identified vehicles;
- b. The alarms protocol, containing data about the vehicles, for which alarms have been registered. The number of alarms is calculated as follows: "**Number of events in protocol**" minus **2**. For example, if 100 is specified as a value of the **Number of events in protocol** field, then 98 alarms will be displayed in the alarm protocol.

3. Set the **Delete alarms together with the LP** checkbox (2) if it is necessary to delete all events connected to the last number in the queue when exceeding the specified number of events in the protocol.
4. Set the **Speed** switch (3) to the position, corresponding to the vehicle's speed unit of measurement that should be displayed in the **Vehicle Tracer** window (km/h or miles/h).
5. By default, in the **Active Monitor** events protocol the following data for every vehicle is displayed:
 - a. Video frame;
 - b. Identified LP number;
 - c. Name of LP recognizer;
 - d. Date and time of receiving the data;
 - e. Reason of alarm (only for alarms).
6. In case only the identified LP number, name of LP recognizer, and date and time of receiving the data should be displayed for each event in the **Active Monitor** events protocol, set the **Reduced view of protocols** checkbox (4).
7. You can create additional **Active Monitor** components. If the alarms protocol should be displayed only in the main interface component of **Active Monitor** and not in the additional ones, set the **Protocol of alarms only in main Active Monitor window** checkbox (5).
8. By default, the number of additional **Active Monitor** components that should be displayed is not restricted. If only the most recent additional **Active Monitor** component should be displayed, set the **Only one additional Active Monitor window** checkbox (6).

9. Set the **Do not display the regional code** checkbox (7) if it is necessary to hide the **Regional code** field from the **Active Monitor** component.
10. Set the **Display the fields of an external DB** checkbox (8) if it is necessary to display the fields of an external DB in the **Active Monitor** component when the license plate is found in the external license plate database (see [Assigning names to table columns containing LP numbers](#)).
11. In the **DB timeout, s** field (9), specify in seconds the timeout for connecting to the selected *Auto Intellect* servers when the **Event search in the Recognizers DBs** window is opened (see [Configuring the events search](#)). If the specified time is exceeded, all connection attempts are terminated and a list of Servers to which it was not possible to connect is displayed.
12. In the **Interval between start and end date** field (10), specify in days the expiration time of the suspect vehicle profile. The default value is 7 days. After that, the specified interval will be automatically moved to the form for entering a new suspect vehicle profile in the Active tracking database as a difference between the **Start date** and **Expiration date** fields (see [Creating the Active tracking database](#)).
13. Click the **Ok** button to save the changes and close the **Settings** dialog window.
14. Click The **Apply** button to save the changes on the **Vehicle Tracer** settings panel.

Setting up the **Vehicle Tracer** interface window is complete.

5.6.7 Setting up the audio notification while registering the alarms

There is a possibility to set up the audio notification while registering the following alarms:

1. Vehicle overspeeding;
2. Identifying the recognized plate in the external LPs database.

Setting up the audio notification while registering the alarms is done in the following way:

1. Go to the **Vehicle Tracer** settings panel.

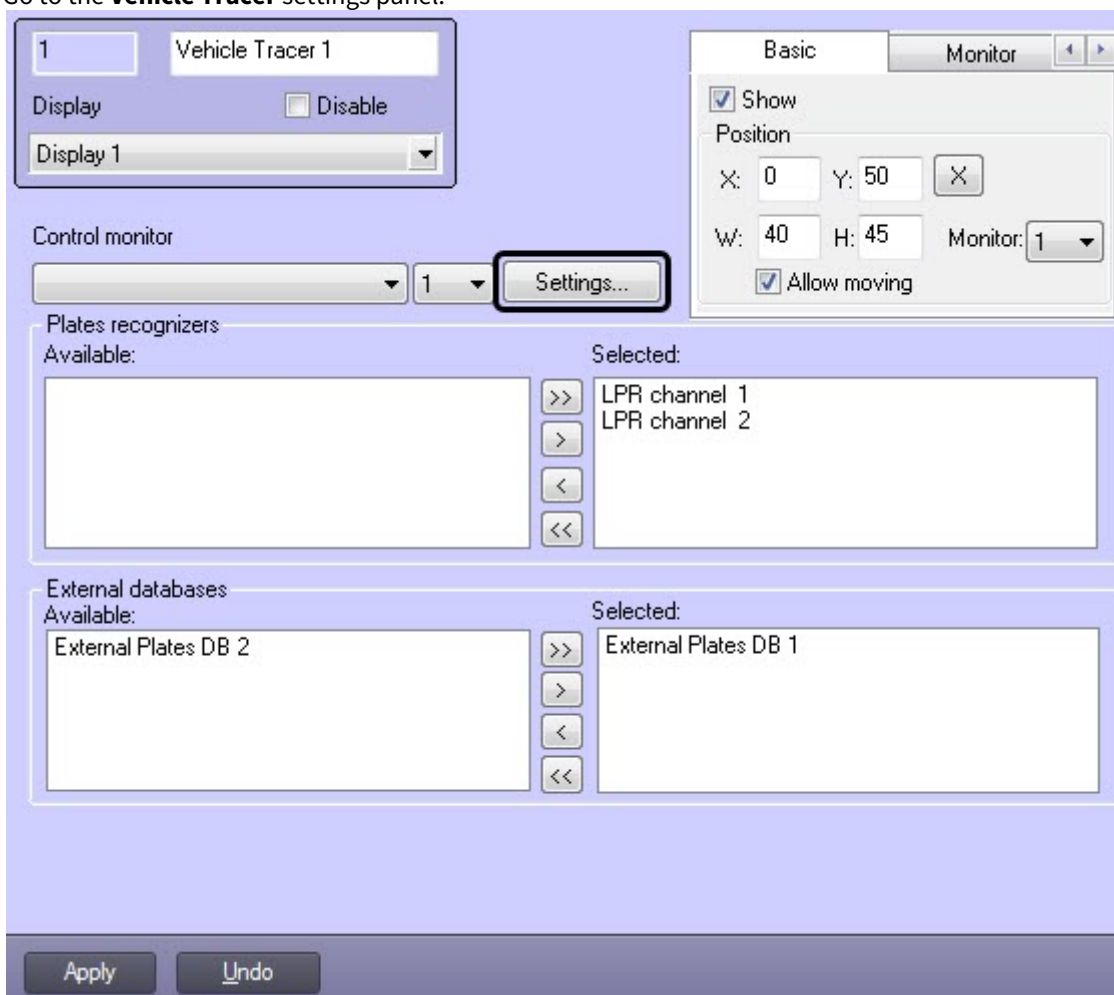

2. Click the **Settings** button.
3. Go to the **Audio notification** tab in the opened dialog window (1).

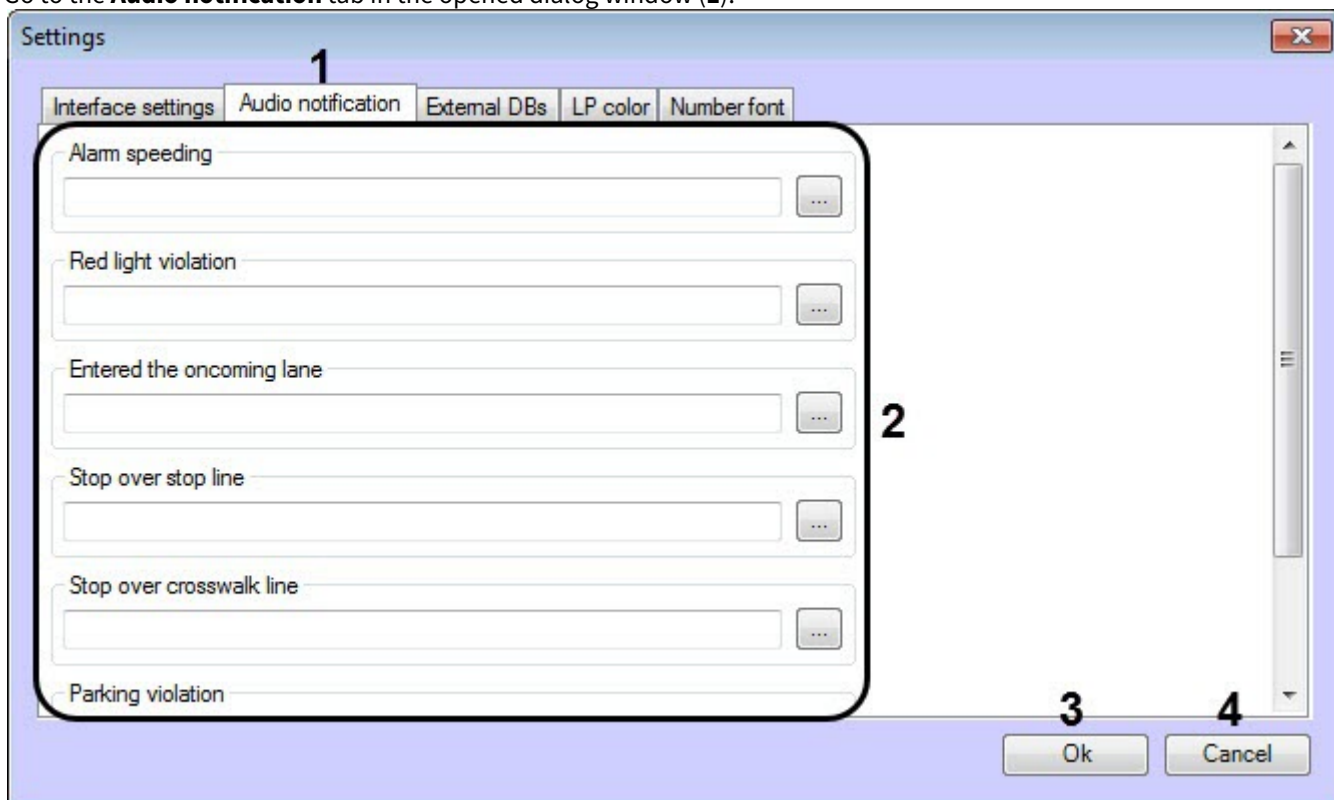

4. Select the required alarm or external database from the (2) field and click the  button to the right of it. In the opened standard dialog window **Open** the required sound file and then click **Open**. As a result, the full path to the sound file will be displayed in the field corresponding to the selected alarm or external database.

Note

The number and the names of the external databases displayed on the **Audio notification** tab correspond to those external databases that were pre-selected for analyzing the identified plates (see [Selecting the external plate's database](#)).

5. Repeat step 4 for all the required alarms or external databases.
6. Click **OK** to save the changes and close the **Settings** dialog window (3).

Note

Click **Cancel** to close the **Settings** dialog window without any changes (4).

7. Click **Apply** to save the changes on the **Vehicle Tracer** settings panel.

Setting up the audio notification while registering the alarms is completed.

5.6.8 Selecting the external LPs databases as the Active tracking databases

To select the external databases that should be used as the **Active tracking** databases, do the following:

1. Go to the **Vehicle Tracer** settings panel.

The screenshot shows the 'Vehicle Tracer 1' settings panel. At the top left, there is a 'Display' section with a 'Disable' checkbox and a 'Display 1' dropdown menu. Below this is a 'Control monitor' section with a dropdown menu and a 'Settings...' button highlighted with a red box. To the right of the 'Control monitor' section is a 'Basic' tab with a 'Monitor' dropdown menu. The 'Basic' tab contains a 'Show' checkbox, a 'Position' section with 'X: 0', 'Y: 50', 'W: 40', and 'H: 45' fields, and an 'Allow moving' checkbox. Below the 'Control monitor' section are two sections: 'Plates recognizers' and 'External databases'. Each section has an 'Available' list and a 'Selected' list. In the 'Plates recognizers' section, 'LPR channel 1' and 'LPR channel 2' are in the 'Selected' list. In the 'External databases' section, 'External Plates DB 1' is in the 'Selected' list. At the bottom of the panel are 'Apply' and 'Undo' buttons.

2. Click the **Settings** button.

- Go to the **External DBs** tab in the opened dialog window (1).

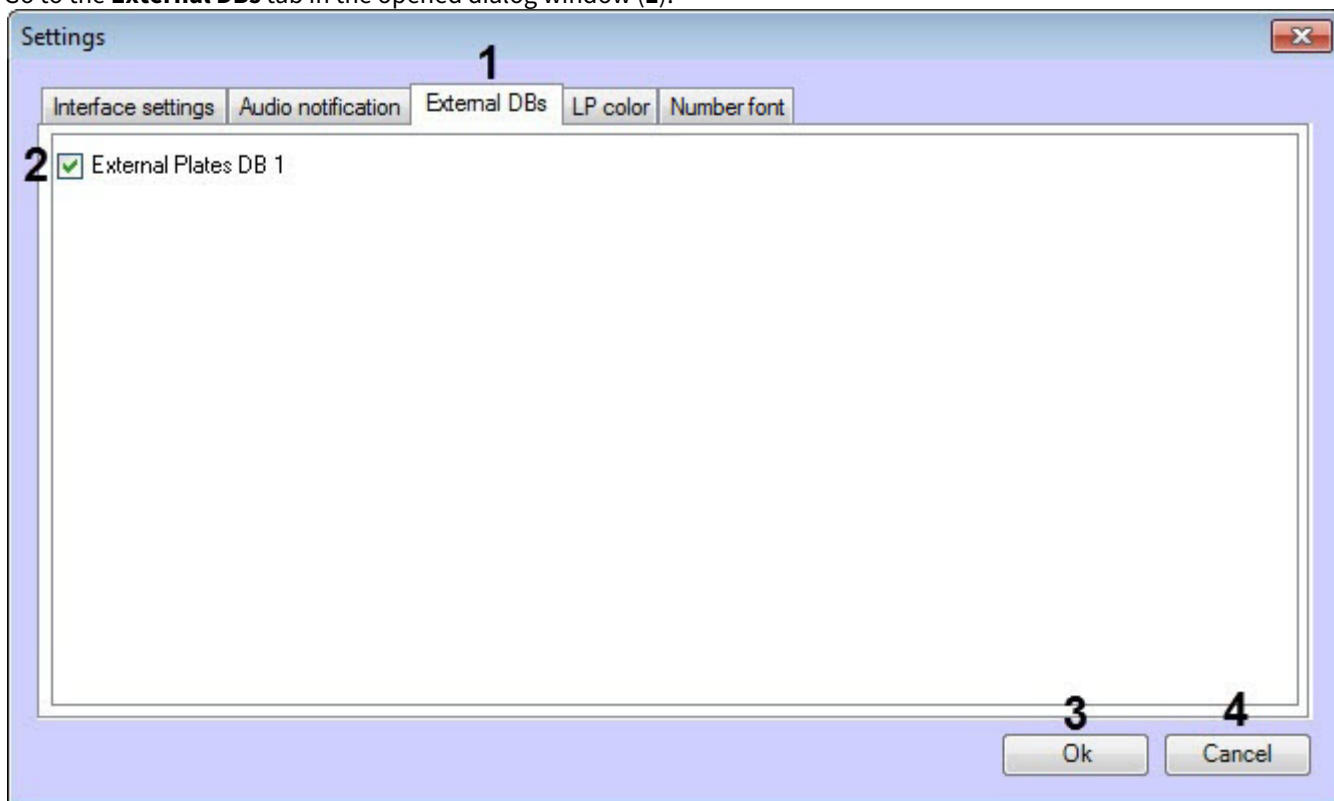

- Select the check boxes for those external databases that should be used as the **Active tracking** databases (2).

Note.

To select the external databases as the **Active tracking** databases it's required to select the local database with specified **Catch_DB** table and **Plate** field while configuring the External Plates databases (for the detailed information about External Plates databases configuring, see [Connecting the external database](#)).

- Click **OK** to save the changes and close the **Settings** dialog window (3).

Note

Click **Cancel** to close the **Settings** dialog window without saving the changes (4).

- Click **Apply** to save the changes on the **Vehicle Tracer** settings panel.

Selecting the external databases as the Active tracking databases is completed.

5.6.9 Setting up color for LP recognition events

You can set up the color to highlight the events when the violations are detected (for example, speeding), as well as the color to highlight the events when a LP number is detected in the External DBs.

To do that:

1. Go to the **Vehicle Tracer** settings panel.

1 Vehicle Tracer 1

Display Disable

Display 1

Control monitor

1 Settings...

Plates recognizers

Available:

Selected:

LPR channel 1
LPR channel 2

External databases

Available:

External Plates DB 2

Selected:

External Plates DB 1

Apply Undo

2. Click the **Settings** button.

3. In the opened **Settings** dialog window, click the **LP color** tab.

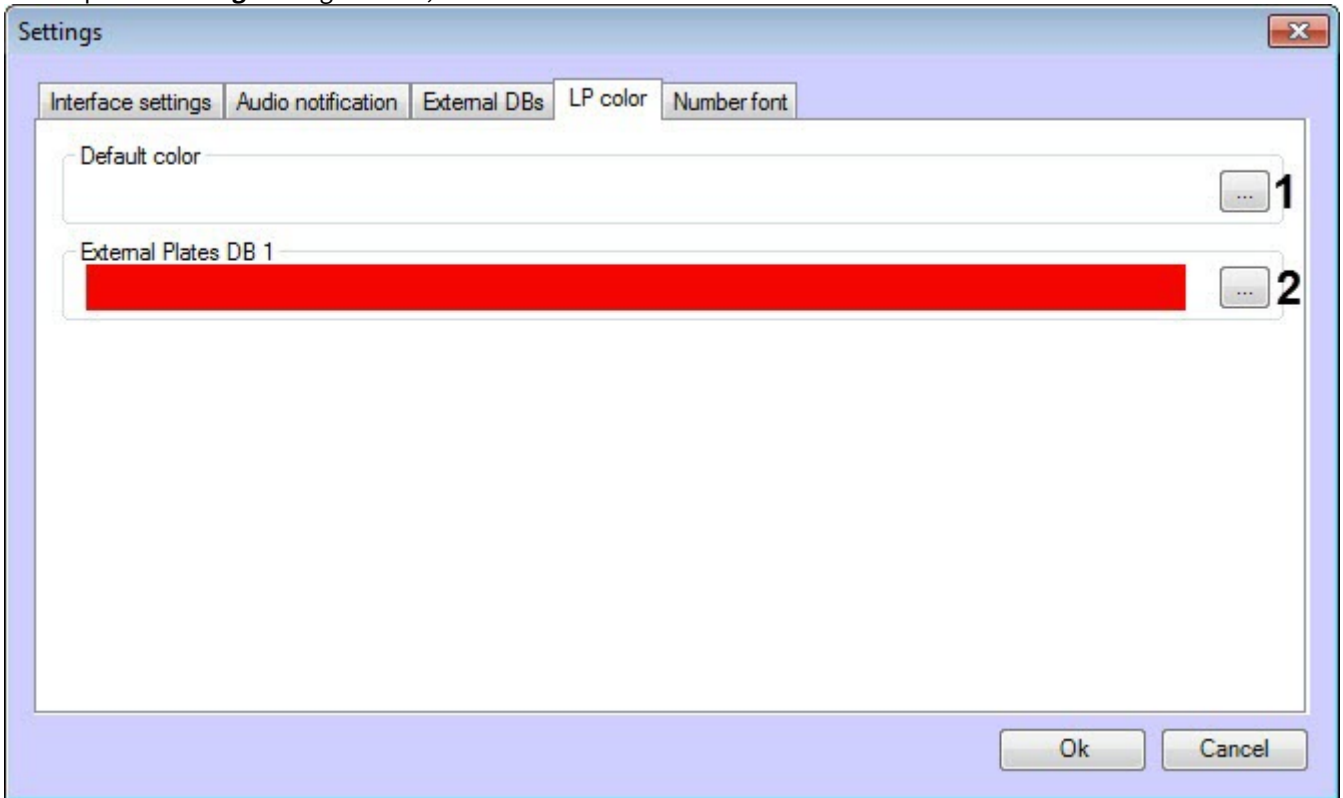

4. In the **Default color** field, click the  button (1).
5. In the opened **Color** dialog window, select the required color to highlight the events when the violations are detected, and click **OK**.

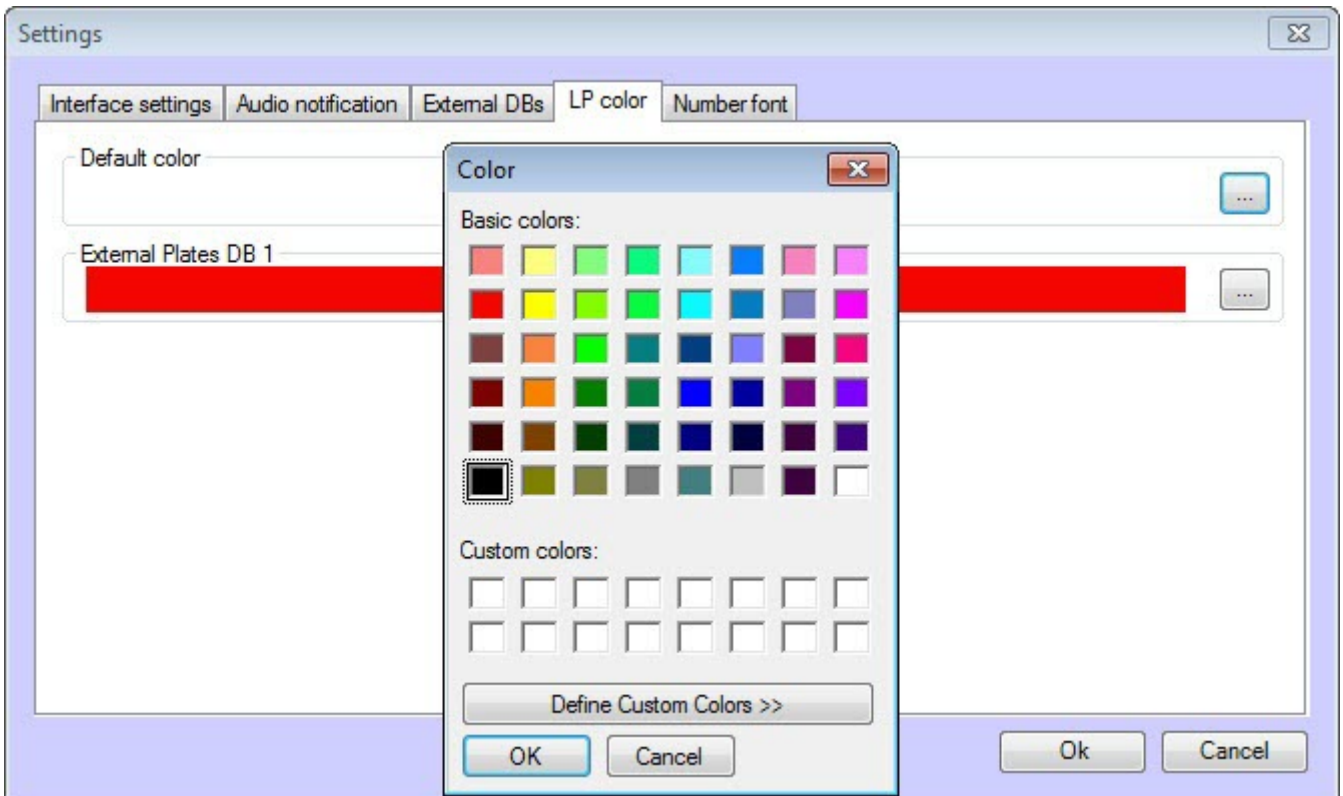

6. Repeat steps 4 and 5 to set up the color for the **External Plates DB** fields (2), if they were pre-selected beforehand (see [Selecting the external LPs databases as the Active tracking databases](#)). This color will be used to highlight the events when a LP number is detected in the External DBs.

7. As a result, the selected colors will be displayed in the corresponding fields.

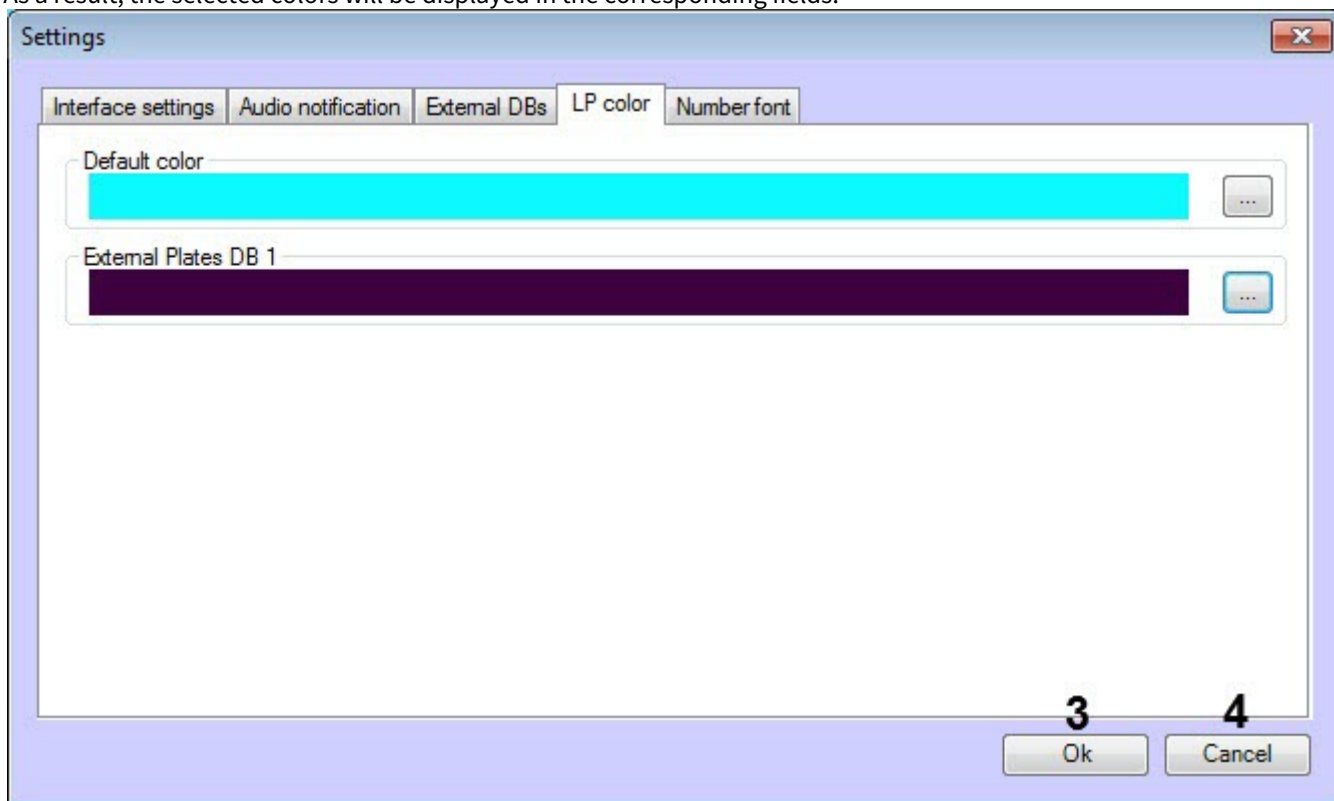

8. To save the changes, click **OK (3)**.

Note

To close the dialog window without any changes, click **Cancel (4)**.

9. Click **Apply** to save the changes on the **Vehicle Tracer** settings panel.

The colors for LP recognition events are set up.

5.6.10 Selecting the Monitor object for playing back the video archive

It is possible from the **Vehicle Tracer** window to view the video archive by event, received from the video camera used for the license plate recognition (see [Viewing the video archive by event](#)).

Select the monitor for displaying the video archive playback as follows:

1. Go to the settings panel of the **Vehicle Tracer** object.

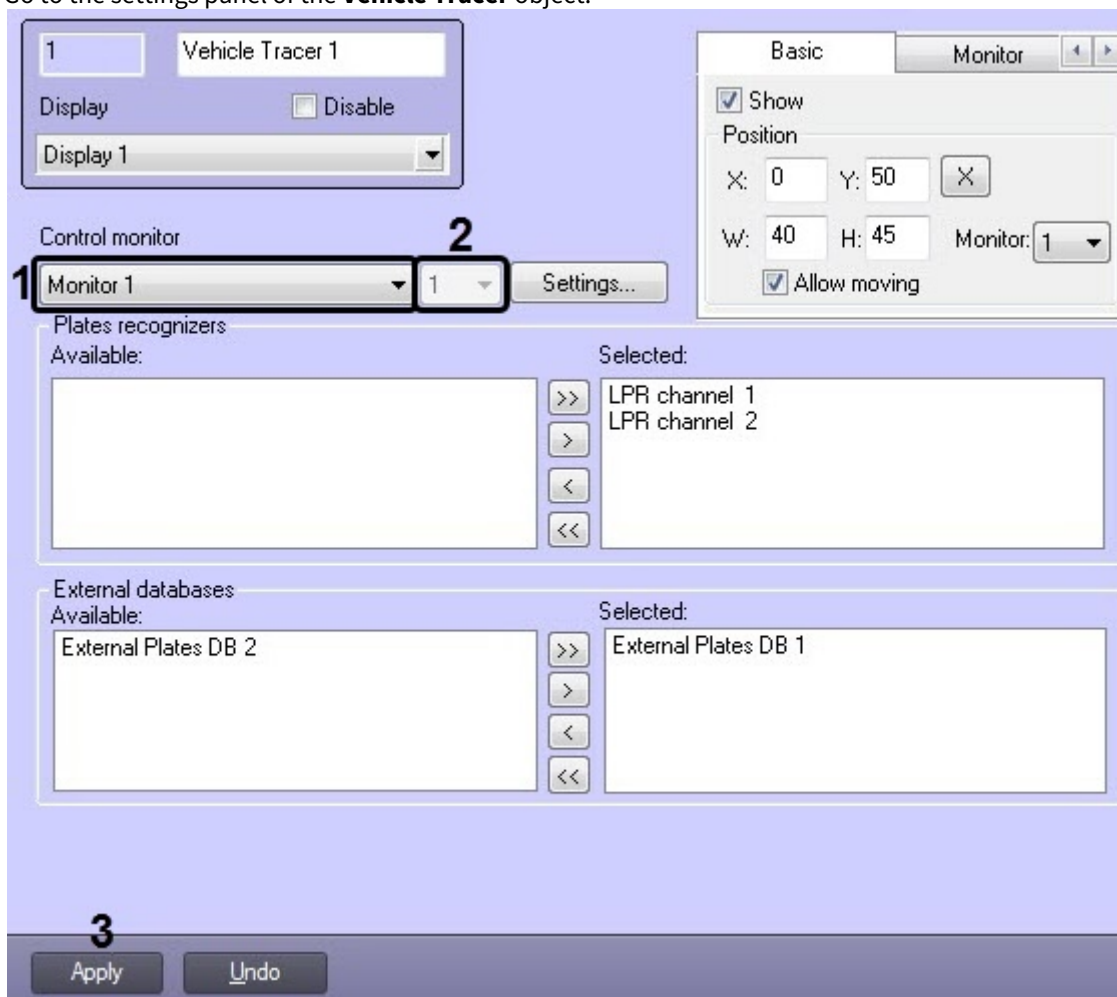

2. From the **Control monitor** drop-down list (1), select:
 - The **Monitor** object - for playing back the video archive in the specified **Monitor** interface object.

⚠ Attention!

The **Monitor** and **Vehicle Tracer** objects should be created on the basis of one parent object **Screen**.

- The **AxxonNext monitor** object - for playing back the video archive in *Axxon Next* if the joint operation of *Auto Intellect* and *Axxon Next* is enabled (see [Setting up the joint operation of Auto Intellect and Axxon Next](#)). It is also necessary to select from the drop-down list (2) the number of the physical monitor with the video camera layout in *Axxon Next*, which is used for the license plates recognition.
3. Click **Apply** (3).

Selecting the **Monitor** object for playing back the video archive is completed.

5.6.11 Setting up the font of the recognized LP number

You can select the font of the recognized license plate in the **Online monitor** and **Event monitor** components. This can be useful if the characters of the recognized license plate are displayed incorrectly due to the lack of these characters in the currently selected font. To ensure the correct display of the recognized number, it is necessary that the selected font and character set correspond to the country whose numbers are to be recognized.

Configure the font of the recognized license plate as follows:

1. Go to the **Vehicle Tracer** object settings panel and click the **Settings** button.

- In the opened **Settings** dialog window, click the **Number font** tab.

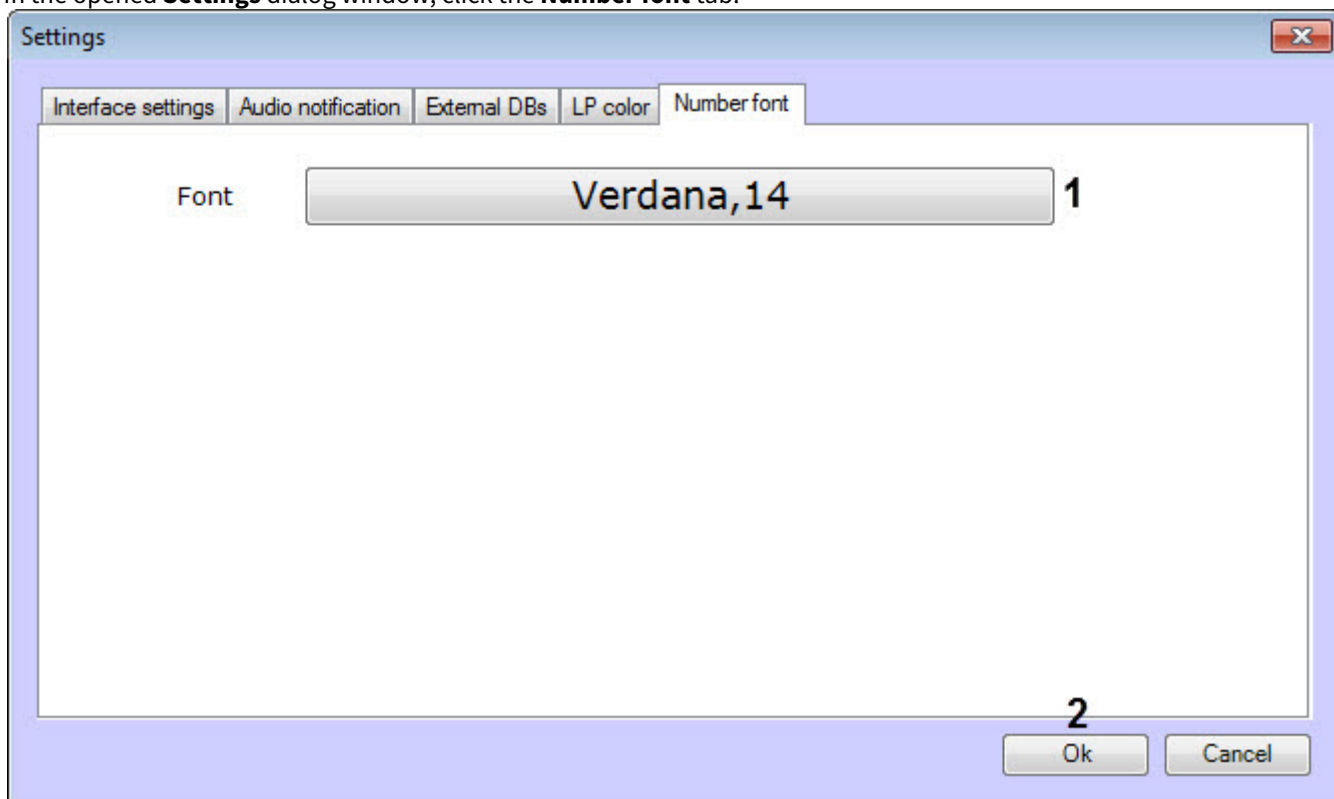

- Click the button with the font name (1).
- In the **Font** dialog box that opens, select the required font, its style, size and script. Click **OK**.

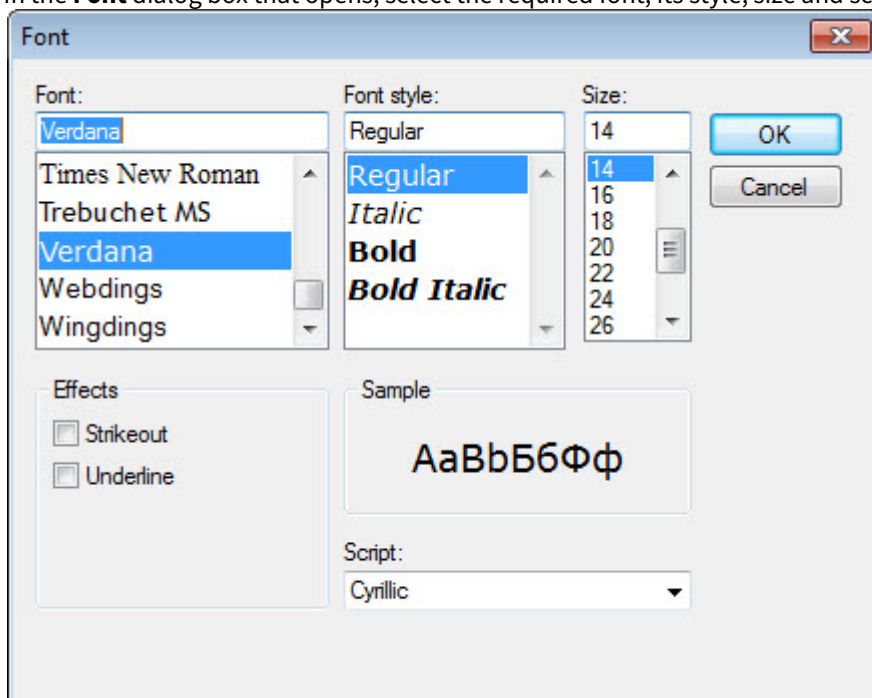

- To save changes, click **OK** (2).
- Click **Apply** on the **Vehicle Tracer** settings panel.

Setting up the font of the recognized license plate is complete.

6 Appendices

6.1 Appendix 1. Interface description

6.1.1 The LPR channel object settings panel

The settings panel of the **LPR channel** object includes the following interface elements.

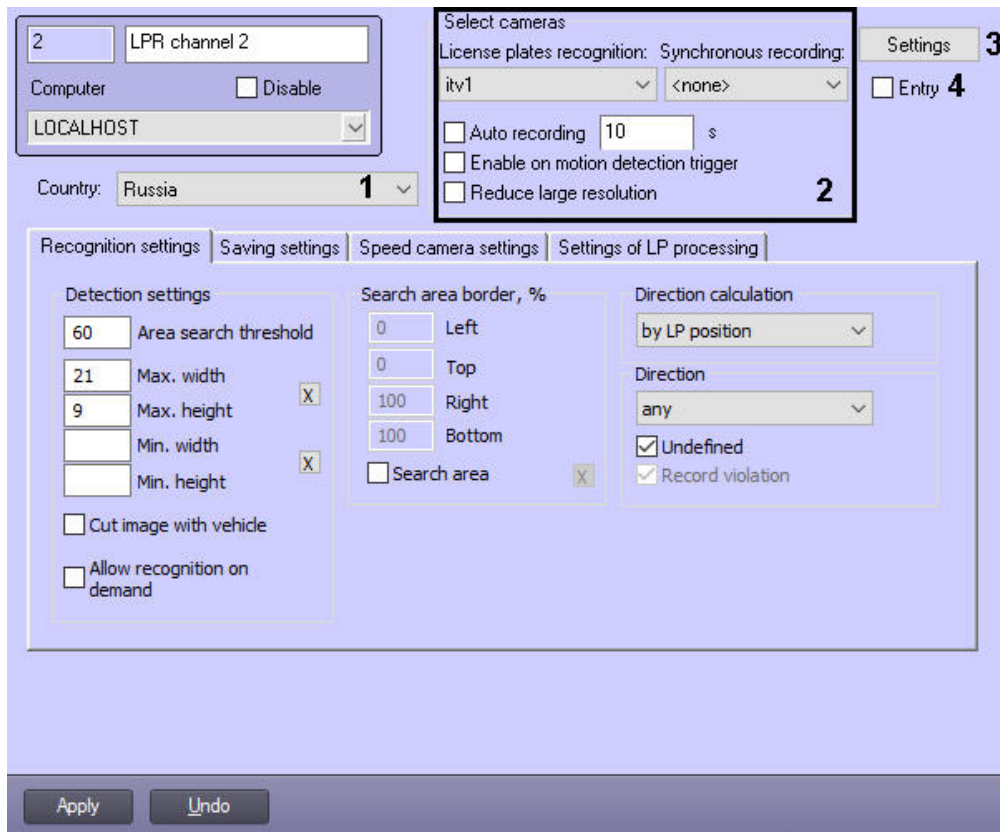

№	Parameter name	Parameter setting method	Description	Data type	Default value	Value range
1	Country	Select value from the list	<p style="text-align: center;"><i>For AUTO-Uragan, VIT, RoadAR, LPR IntelliVision software modules</i></p> Selection of the country which numbers it is necessary to recognize	List of available national license plate templates	Depending on the recognition module	Depending on the number of available national license plate templates

Module	Select value from the list	For <i>CARMEN-Auto</i> , <i>ARH-Railway</i> software modules			
		Selection of the license plate recognition SDK	List of license plate recognition SDK	Depending on the recognition module	Depending on the number of installed license plate recognition SDK
2	Select cameras group				
License plates recognition	Select value from the list	Main video camera for license plate recognition	List of available Camera objects	Camera 1	Depending on the number of available Camera objects
Synchronous recording	Select value from the list	Additional video camera operating together with the main camera	List of available Camera objects	None	Depending on the number of available Camera objects
Auto recording	Set the checkbox	Enabling the automatic recording on the LP number recognition	Boolean	No	Yes—automatic recording enabled, No—automatic recording disabled
Auto recording, s	Enter the value in the text field	Setting the auto recording duration (in seconds)	Seconds	10	0-86400

	<p>Set the checkbox</p>	<p>Starting auto recording on receiving an event from the motion detector</p>	<p>Boolean</p>	<p>No</p>	<p>For normal mode: Yes—if the camera is armed, the LPR channel scans all video images until the basic motion detection of the Intellect software is in the Alarm mode; If the camera is not armed, the LPR doesn't work, but manual start using scripts is available (see item 6 in the Scripts used in the Auto-Intellect software package section). Recognition will process frames until the stop command will be done No—the LPR channel scans video images permanently For Parking mode: Yes—if the camera is armed, the LPR channel scans all video images, until the plate will be recognized, after it recognition stops even if the Alarm mode is still in process and procedure repeats when the new trigger of alarm is activated; if the camera is not armed, the LPR doesn't work, but manual start using scripts is available (see item 6 in the Scripts used in the Auto-Intellect software package section). Recognition will process frames until the plate will be recognized and then will stop before new manual start No—the LPR channel scans video images permanently</p>
	<p>Set the checkbox</p>	<p>Frame handling setup</p>	<p>Boolean</p>	<p>Yes</p>	<p>Yes—the lesser frame is stretched, the bigger one is cut off No—the lesser frame is stretched, the bigger one is handled without changes</p>
<p>3</p>	<p>Settings button Not available for: <ul style="list-style-type: none"> • <i>Remote recognition</i> • <i>ARH-Railway</i> • <i>CARME N-Auto</i> • <i>IntLab</i> </p>	<p>Click the button Access to frame sign settings</p>	<p>-</p>	<p>-</p>	<p>-</p>

4	Entry	Set the checkbox	The vehicle movement direction will be treated as Entry to the territory	Boolean	No	<p>Yes—the LPR channel considers the vehicle's movement direction as Entry to the territory</p> <p>No—the LPR channel does not consider the vehicle's movement direction as Entry to the territory</p> <p><i>Note. This setting is taken into account in the Intellect Web Report System when working with Auto reports (see Intellect Web Report System. User Guide)</i></p>
---	--------------	------------------	---	---------	----	---

The **Recognition settings** tab

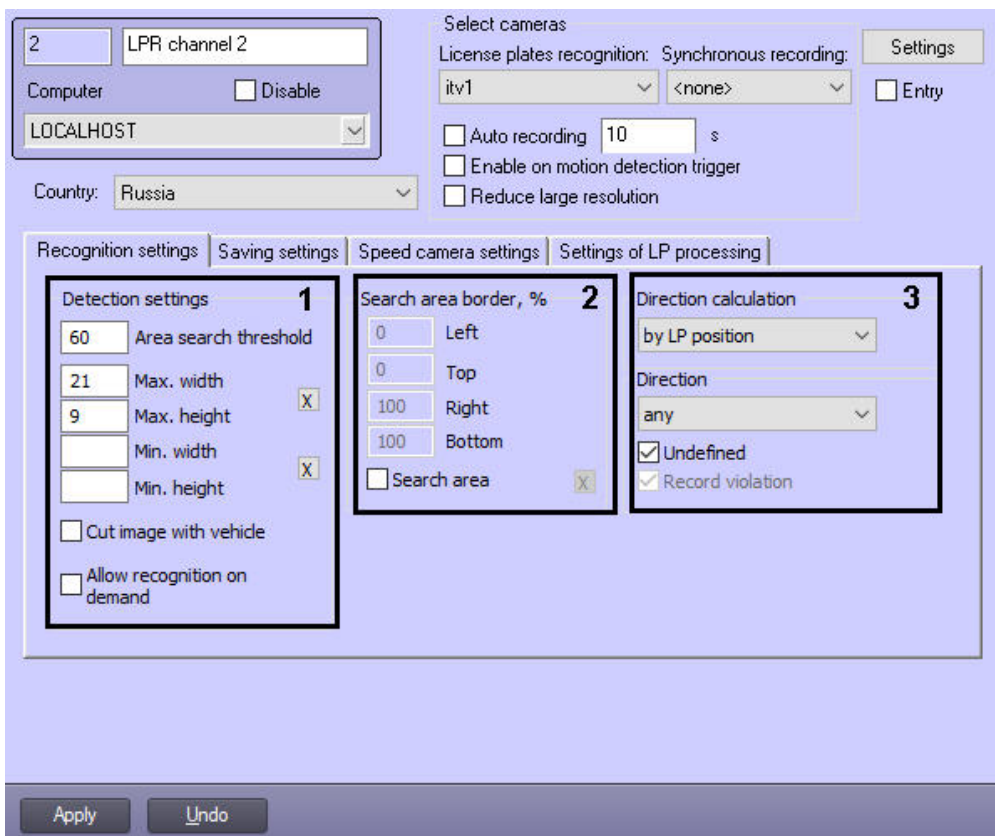

No	Parameter name	Parameter setting method	Description	Data type	Default value	Value range
1	Detection settings group					
	<p>Area search threshold</p> <p>Available for:</p> <ul style="list-style-type: none"> <i>AUTO-Uragan</i> <i>LPR IntelliVision</i> 	Enter the value in the text field	Detecting zone sensitivity	Number	60	0-100

No	Parameter name	Parameter setting method	Description	Data type	Default value	Value range
	Max. width Available for: <ul style="list-style-type: none"> • <i>AUTO-Uragan</i> • <i>IntLab</i> • <i>LPR IntelliVision</i> • <i>Taiwan</i> • <i>VIT</i> 	Enter the value in the text field	Maximum available width of license plate	Percentage of frame width	21	0-100
	Max. height Available for: <ul style="list-style-type: none"> • <i>AUTO-Uragan</i> • <i>IntLab</i> • <i>LPR IntelliVision</i> 	Enter the value in the text field	Maximum available height of license plate	Percentage of frame height	9	0-100
	Button X Available for: <ul style="list-style-type: none"> • <i>AUTO-Uragan</i> • <i>LPR IntelliVision</i> 	Click the button	Access to the interactive interface of setting the area width and height	-	-	-
	Min. width Available for: <ul style="list-style-type: none"> • <i>AUTO-Uragan</i> • <i>LPR IntelliVision</i> • <i>Taiwan</i> • <i>VIT</i> 	Enter the value in the text field	Minimum available width of license plate	Percentage of frame width	-	0-100
	Min. height Available for: <ul style="list-style-type: none"> • <i>AUTO-Uragan</i> • <i>LPR IntelliVision</i> 	Enter the value in the text field	Minimum available height of license plate	Percentage of frame width	-	0-100
	Button X Available for: <ul style="list-style-type: none"> • <i>AUTO-Uragan</i> • <i>LPR IntelliVision</i> 	Click the button	Access to the interactive interface of setting the area width and height	-	-	-
	Cut image with vehicle Available for: <ul style="list-style-type: none"> • <i>AUTO-Uragan</i> • <i>Bioiris</i> • <i>CARMEN-Auto</i> • <i>LPR IntelliVision</i> • <i>Remote recognition</i> • <i>RoadAR</i> • <i>Taiwan</i> • <i>VIT</i> 	Set the checkbox	Set up the detection settings to the image with a car	Boolean	No	Yes—frame with a vehicle is cut No—frame with a vehicle is not cut

No	Parameter name	Parameter setting method	Description	Data type	Default value	Value range
	Allow recognition on demand Available for: <ul style="list-style-type: none"> • <i>CARMEN-Auto</i> • <i>RoadAR</i> • <i>VIT</i> • <i>Taiwan</i> • <i>ARH-Railway</i> 	Set the checkbox	Enable the image recognition on demand	Boolean	No	Yes—on-demand image recognition is enabled No—on-demand image recognition is disabled
2	Search area border, % group					
	Left	Enter the value in the text field	Left edge of the LP number search area (%)	% relative to the width of the surveillance window	0	0-100
	Top	Enter the value in the text field	Top edge of the LP number search area (%)	% relative to the width of the surveillance window	0	0-100
	Right	Enter the value in the text field	Right edge of the LP number search area (%)	% relative to the width of the surveillance window	100	0-100
	Bottom	Enter the value in the text field	Bottom edge of the LP number search area (%)	% relative to the width of the surveillance window	100	0-100
	Search area	Set the checkbox	Enabling the option of the LP number search area boundaries setting	Boolean	No	Yes—the option of the LP number search area boundaries setting is enabled No—the option of the LP number search area boundaries setting is disabled
	Button X	Click the button	Setting the search area using the mouse	-	-	-
3	Direction group					

No	Parameter name	Parameter setting method	Description	Data type	Default value	Value range
	Direction calculation	Select value from the list	Sets the mode of determining the vehicle's movement direction	List	by LP position	<p>by LP position—the direction is determined by the position of the upper part of the LP number. If the upper part of the LP number at the start of tracking is lower than the upper part of the LP number at the end of tracking, then the direction is defined as From the camera, otherwise — To the camera.</p> <p>by LP area—the direction is determined by the license plate area. If the LP area at the start of tracking is larger than the LP area at the end of tracking, then the direction is defined as From the camera, otherwise — To the camera.</p> <p>by SDK—the direction is determined by the SDK. Currently, the following LP recognition modules support this mode: <i>RoadAR</i>, <i>VIT</i>, <i>AUTO-Uragan</i>, <i>LPR IntelliVision</i></p>
	Direction Available for: <ul style="list-style-type: none"> • <i>AUTO-Uragan</i> • <i>Bioiris</i> • <i>IntLab</i> • <i>Remote recognition</i> • <i>RoadAR</i> • <i>Taiwan</i> • <i>VIT</i> • <i>RIDR IntelliVision</i> • <i>CIDR IntelliVision</i> 	Select value from the list	Setting the traffic direction to detect the LP numbers	List	any	<p>Any—the direction of movement from the video camera or towards the video camera</p> <p>From the camera—the direction of movement from the video camera</p> <p>To the camera—the direction of movement towards the video camera</p> <p>For the IntLab, RIDR IntelliVision and CIDR IntelliVision modules, the direction of carriage movement in the camera view is selected from left to right or from right to left</p>

No	Parameter name	Parameter setting method	Description	Data type	Default value	Value range
	<p>Undefined</p> <p>Available for:</p> <ul style="list-style-type: none"> • ARENA • AUTO-Uragan • Bioiris • CARMEN-Auto • IntLab • Remote recognition • RoadAR • Taiwan • VIT • RIDR IntelliVision • CIDR IntelliVision 	Set the checkbox	Enables to display the direction as Undefined in the <i>Vehicle Tracer</i> module, if it is impossible to determine the vehicle direction	Boolean	Yes	<p>Yes—if it is impossible to determine the direction of vehicle movement, the direction is displayed as Undefined</p> <p>No—if it is impossible to determine the direction of vehicle movement, the direction is not determined</p>
	<p>Record violation</p> <p>Only used when direction is selected in the Direction list (To the camera/ From the camera)</p>	Set the checkbox	Enabling event generating in case of vehicle entering an oncoming lane	Boolean	Yes	<p>Yes—in case if the direction of vehicle moving is not coincide with the specified in the Direction list, the Entered the oncoming lane alarm event will be created</p> <p>No—the Entered the oncoming lane alarm event is not created</p>

The **Saving settings** tab

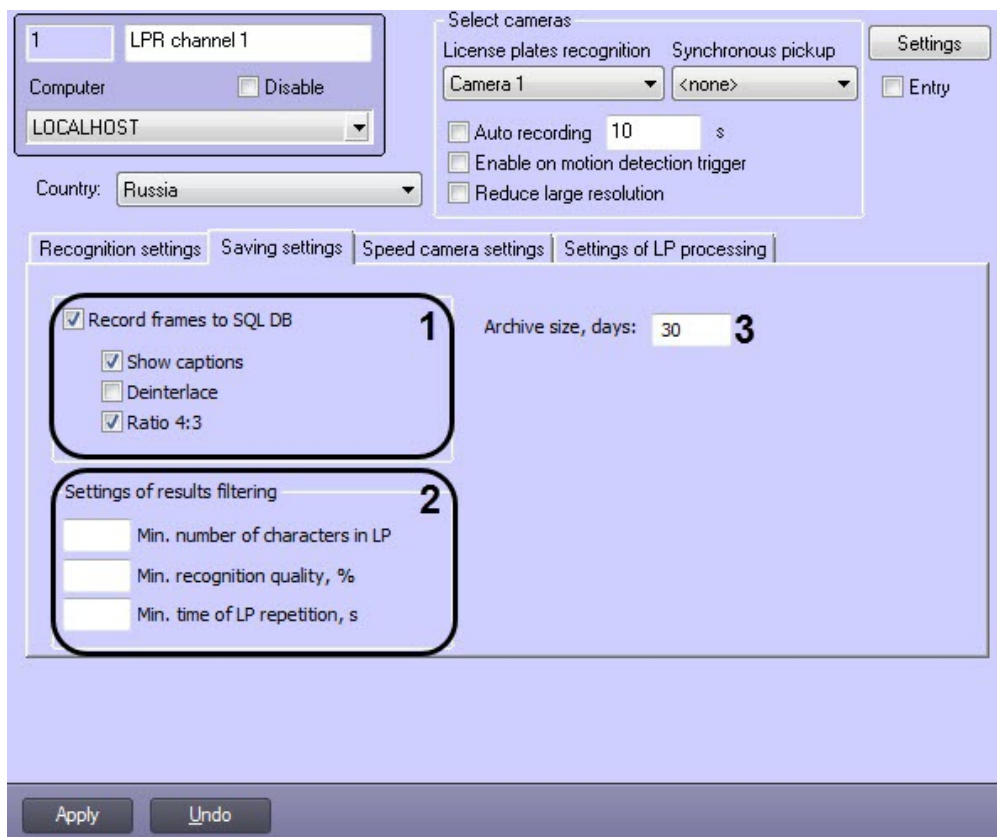

No	Parameter name	Parameter setting method	Description	Data type	Default value	Value range
1	Record frames to SQL DB	Set the checkbox	Saving video frames of vehicle's recognized number into SQL DB	Boolean	Yes	Yes—the frame with a vehicle is saved into the database No—the frame with a vehicle is not saved into the database
	Show captions	Set the checkbox	Enabling the LP number titles overlaid with the video image while making report about the recognized number	Boolean	Yes	Yes—captions overlay enabled No—captions overlay disabled
	Deinterlace	Set the checkbox	Enables de-interlacing of video frame with a vehicle when the image is received in full resolution	Boolean	No	Yes—de-interlacing of video frame with a vehicle is implemented No—de-interlacing of video frame with a vehicle is not implemented
	Ratio 4:3	Set the checkbox	Set the ratio 4:3 of video frame's width and height while making report about the recognized number	Boolean	Yes	Yes—video frame with a vehicle is displayed in ratio 4:3 No—initial ratio of the frame while making report about the recognized number is not changed
2	Settings of results filtering group					
	Min. number of characters in LP	Enter the value in the text field	Minimum number of characters in the license plate number	Number	-	>0
	Min. recognition quality, %	Enter the value in the text field	Minimum image quality for license plate recognition	%	-	0-100%
	Min. time of LP repetition, s	Enter the value in the text field	Minimum time of repetition of the license plate on video	Seconds	-	0-3600
3	Archive size, days	Enter the value in the text field	Database archive depth	Days	30	0-5000

The **Speed camera settings** tab

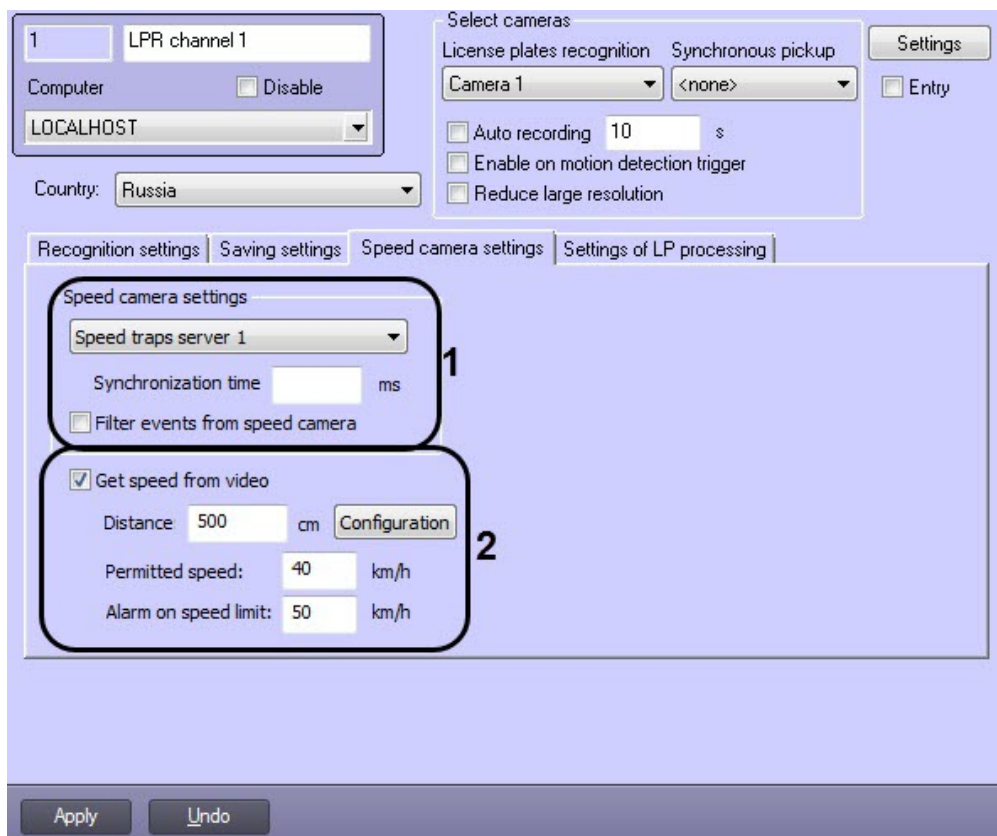

No	Parameter name	Parameter setting method	Description	Data type	Default value	Value range
1	Speed camera settings group					
	Speed camera settings	Select the value from the list	Selecting the speed camera to work together with LPR channel	List of available Speed traps objects	Not specified	Depending on the number of available Speed traps objects
	Synchronization time	Enter the value in the text field	The time it takes the car to move from the point of speed detection by the <i>Speed traps server</i> module to the viewing zone of the camera	Milliseconds	Not specified	0-20000
	Filter events from speed camera	Set the checkbox	Enables saving the first speed detected only	Boolean	No	Yes—only the first detected speed value is used, others are ignored until the delay expires or the number is recognized No—all speed values are used
2	Get speed from video Available for: <ul style="list-style-type: none"> <i>AUTO-Uragan</i> <i>CARMEN-Auto</i> <i>VIT</i> <i>RoadAR</i> 	Set the checkbox	Enables estimation of speed by video via the <i>Auto Intellect</i> algorithm	Boolean	No	Yes—vehicle speed is estimated by video, the results are displayed over video image as captions No—vehicle speed is not estimated by video

No	Parameter name	Parameter setting method	Description	Data type	Default value	Value range
	Configuration	Click the button	Opens a dialog box to set a line segment	-	-	-
	Distance	Enter the value in the text field	Sets length of the line segment in the Get speed from video dialog box, in centimeters	Number	-	>0
	Permitted speed	Enter the value in the text field	Sets permitted vehicle speed on the observed lane	Number	60	>0
	Alarm on speed limit	Enter the value in the text field	Sets maximum vehicle speed. If this speed is exceed, an alarm event is generated	Number	80	>0

The **Settings of LP processing** tab

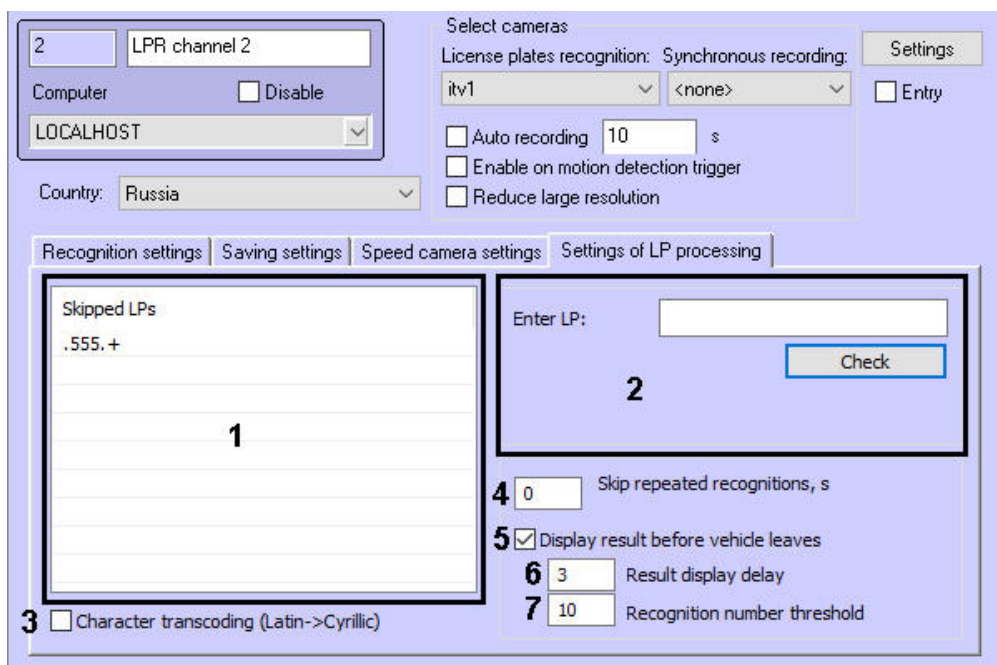

No	Parameter name	Parameter setting method	Description	Data type	Default value	Value range
1	Skipped LPs	Use functional menu	Contains the LP number templates by which the recognized numbers will be ignored if they match the created list by some criterion. For example, the LP numbers of a specific region can be ignored	String	-	-
2	Enter LP	Enter the value in the text field	Specifies an LP number to check if it is contained in an existing template or not	Number	-	>0

No	Parameter name	Parameter setting method	Description	Data type	Default value	Value range
	Check button	Click the button	Activates the check of the specified LP number against the existing template	-	-	-
3	Character transcoding (Latin->Cyrillic)	Set the checkbox	Enables the automatic transcoding of Latin characters into Cyrillic, if the license plate recognition module returns the recognized numbers in Latin characters	Boolean	No	Yes—automatic transcoding of Latin characters to Cyrillic is enabled No—automatic transcoding of Latin characters into Cyrillic is disabled
4	Skip repeated recognitions, s	Enter the value in the text field	Specifies the time period in seconds during which the repeated recognition of one captured license plate will be ignored by the system	Seconds	0	>=0
5	Display result before vehicle leaves Available for: <ul style="list-style-type: none"> • <i>AUTO-Uragan</i> • <i>CARMEN-Auto</i> • <i>VIT</i> 	Set the checkbox	Enabling the results to be displayed before the car leaves the viewing zone	Boolean	Yes	Yes—the result is displayed before the vehicle leaves the frame (the license plate of the given vehicle is out of the license plate search boundaries) No—the result is displayed only after the vehicle leaves the frame
6	Result display delay	Enter the value in the text field	The time delay between the first recognition of the LP number and displaying the results	Seconds	3	0-100
7	Recognition number threshold	Enter the value in the text field	The number of reliable license plate recognitions, after which the recognition result is displayed	Number	2	0-1000

6.1.2 The External Plates DB object settings panel

The **External Plates DB** object settings panel includes the following interface elements:

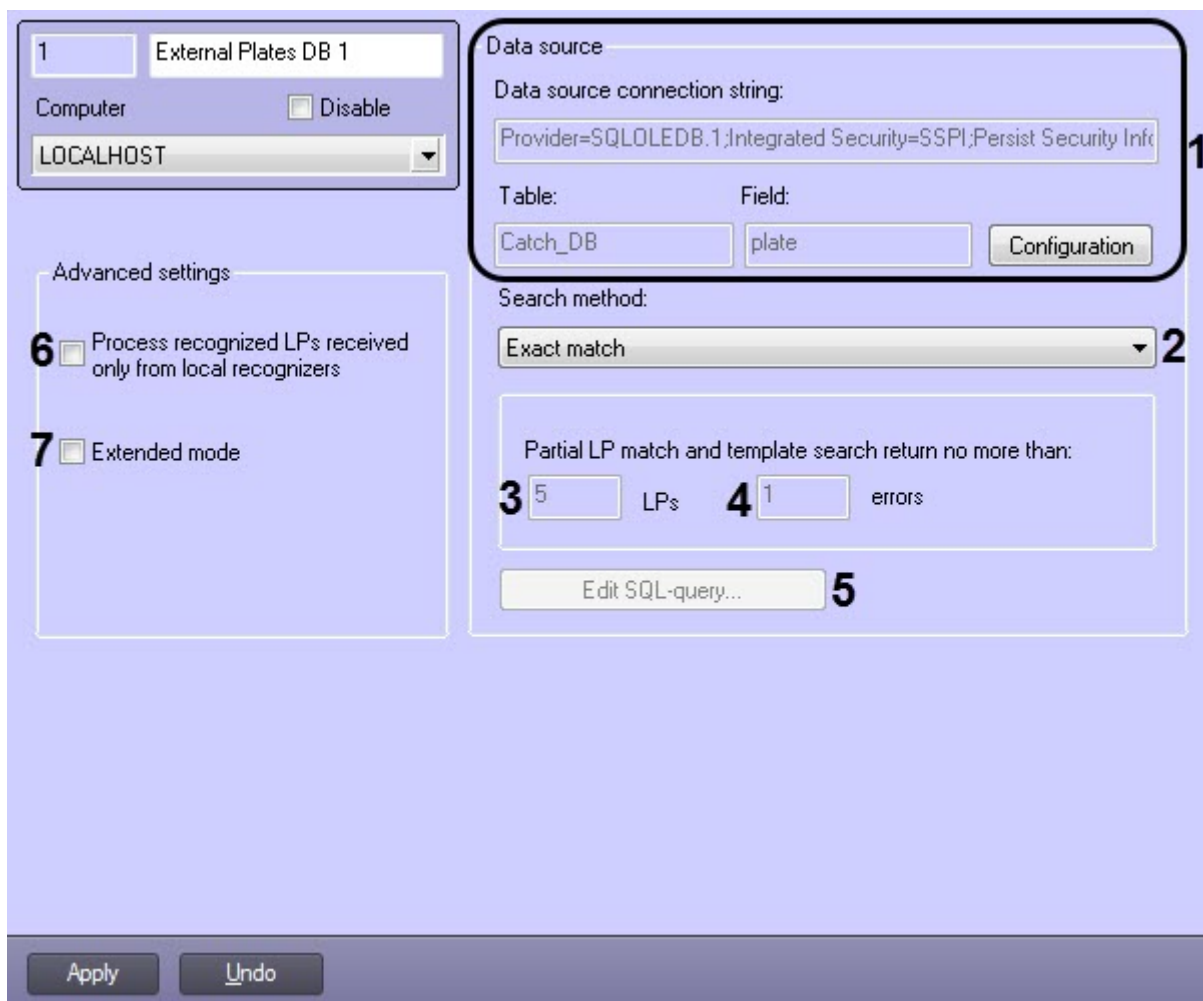

The following table describes the elements of the **External Plates DB** object settings panel.

No	Parameter name	Parameter setting method	Description	Data type	Default value	Value range
1	Data source connection string text field	Automatically, after setting up the connection	Connection string to the external database	Latin and special symbols	-	A sting, containing a sequence of characters (letters, digits, characters)non case-sensitive
	Table text field	Automatically, after setting up the connection	Plates table name in the database	Latin and special symbols	-	A sting, containing a sequence of characters (letters, digits, characters)non case-sensitive
	Field text field	Automatically, after setting up the connection	Plates table name in the database	Latin and special symbols	-	A sting, containing a sequence of characters (letters, digits, characters)non case-sensitive
	Configuration button	Click the button	Access to connection settings	-	-	-

No	Parameter name	Parameter setting method	Description	Data type	Default value	Value range
2	Search method drop-down list	Select the value from the list	Search method selection of identified number in the external database	A list of available search methods	Exact match	<p>Partial search - the found expressions containing the key word in any position and order are returned.</p> <p>Wildcard search - the found expressions matching the given wildcard are returned.</p> <p>Exact match - the found expressions that exactly match the key word are returned.</p> <p>SQL query - the expressions defined by the SQL query are returned.</p> <p>With acceptable number of errors - the found expressions that are partially or completely contained in the number in the external plate database are returned. You can select the maximum number of errors (mismatches of characters) in the number.</p>
3	Partial LP match and template search return no more than...LPs text field	Enter the value in the field	Setting the maximum number of license plates returned when searching by part of the number or number template in the external plates database.	integer	5	1 - 1000
4	Partial LP match and template search return no more than...errors text field	Enter the value in the field	Setting the maximum number of errors (character mismatches) in the search request and numbers in the external plate database.	integer	1	>0
5	Edit SQL-query button	Click the button	Access to SQL-query, used in the search method «SQL-query»	-	-	-
6	Process recognized LPs received only from local recognizers checkbox	Set the checkbox	Specifies the mode when LPs only from local recognizers are processed	Boolean type	No	<p>Yes – the mode when LPs only from local recognizers are processed is enabled.</p> <p>No – the mode when LPs from all recognizers are processed is disabled.</p>
7	Extended mode checkbox	Set the checkbox	Enables the extended mode	Boolean type	No	<p>Yes – the extended mode is enabled.</p> <p>No – the extended mode is disabled.</p>

6.1.3 The IntelliVision vehicle detection settings panel

The **IntelliVision vehicle detection** object settings panel includes the following interface elements:

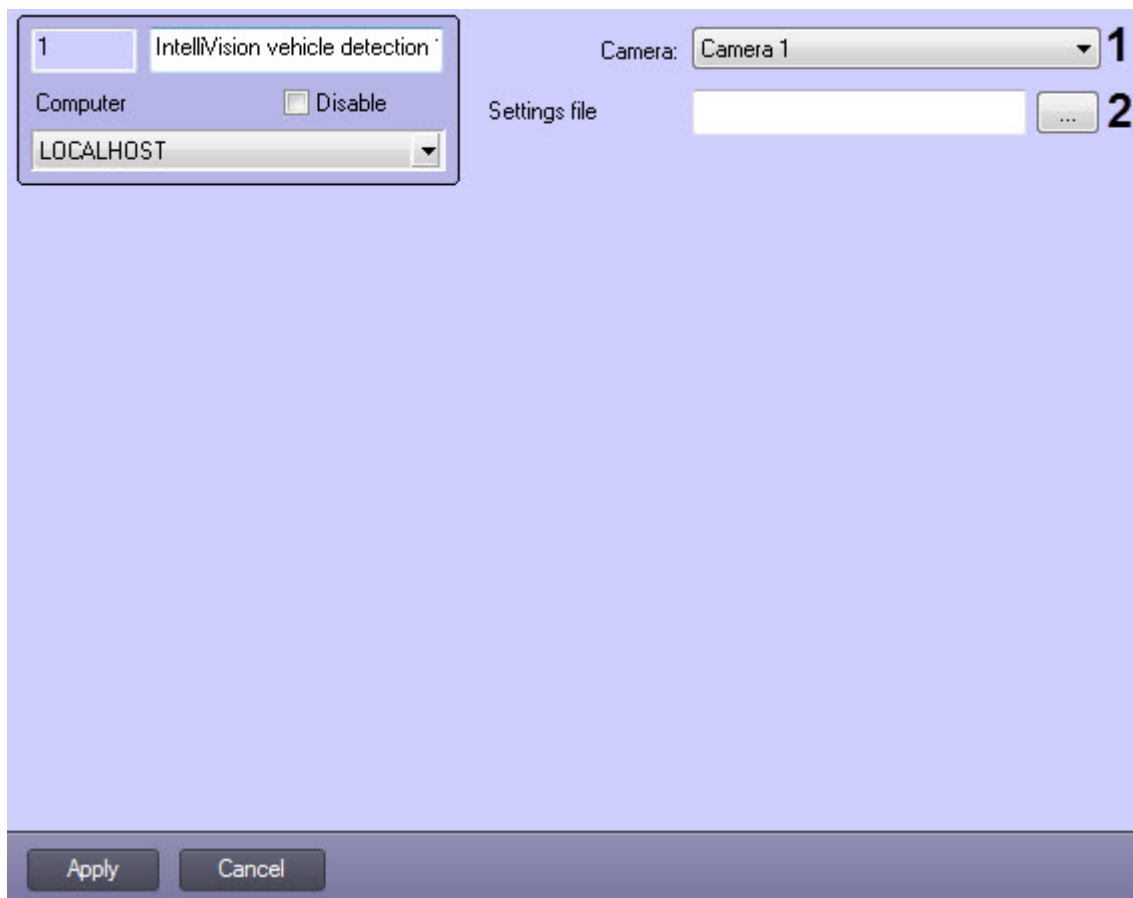

The following table describes the elements of the **IntelliVision vehicle detection** object settings panel.

No	Parameter name	Parameter setting method	Description	Data type	Default value	Value range
1	Camera	Select the value from the list	Set the number of cameras in the IntelliVision vehicle detection	Names of objects, registered in the system Camera	-	Depends on the objects number Camera in the system
2	Settings file	Entering the value in the field/ Clicking the button	Specifies the path to the setup file in the .json format created with the TestAppTMD.exe utility (see TestAppTMD.exe utility for setting up the IntelliVision vehicle detection)	-	-	-

6.1.4 The Parking violation detection module settings panel

The **Parking violation detection** module object settings panel contains the following interface elements:

The following table describes the elements of the **Parking violation detection** object settings panel.

No	Parameter name	Parameter setting method	Description	Data type	Default value	Value range
1	PTZ device drop-down list	Selecting the value in the list	Selecting PTZ device object which will perform the passage between presets	List of accessible PTZ device objects	No	Depending on number of accessible PTZ device
2	Priority drop-down list	Selecting the value in the list	Selecting ptz priority	List of accessible priorities	Low	Low - low ptz priority Standard - middle ptz priority High - high ptz priority
3	Time of stop for recording field	Setting the value in the field	Set time interval during which the vehicle can be in the frame of the same preset until generating the Parking violation alarm.	Second	30	0-99999
4	Initial preset field	Setting the value in the field	Set the number of initial preset of ptz device	Whole nonnegative number	1	1-99999
5	Final preset field	Setting the value in the field	Set the number of final preset of ptz device	Whole nonnegative number	10	1-99999
6	Timeout field	Setting the value in the field	Set time interval after which passage to the next preset is performed	Second	10	0-99999

6.1.5 The Speed traps server object settings panel

The figure shows the **Speed traps server** object settings panel.

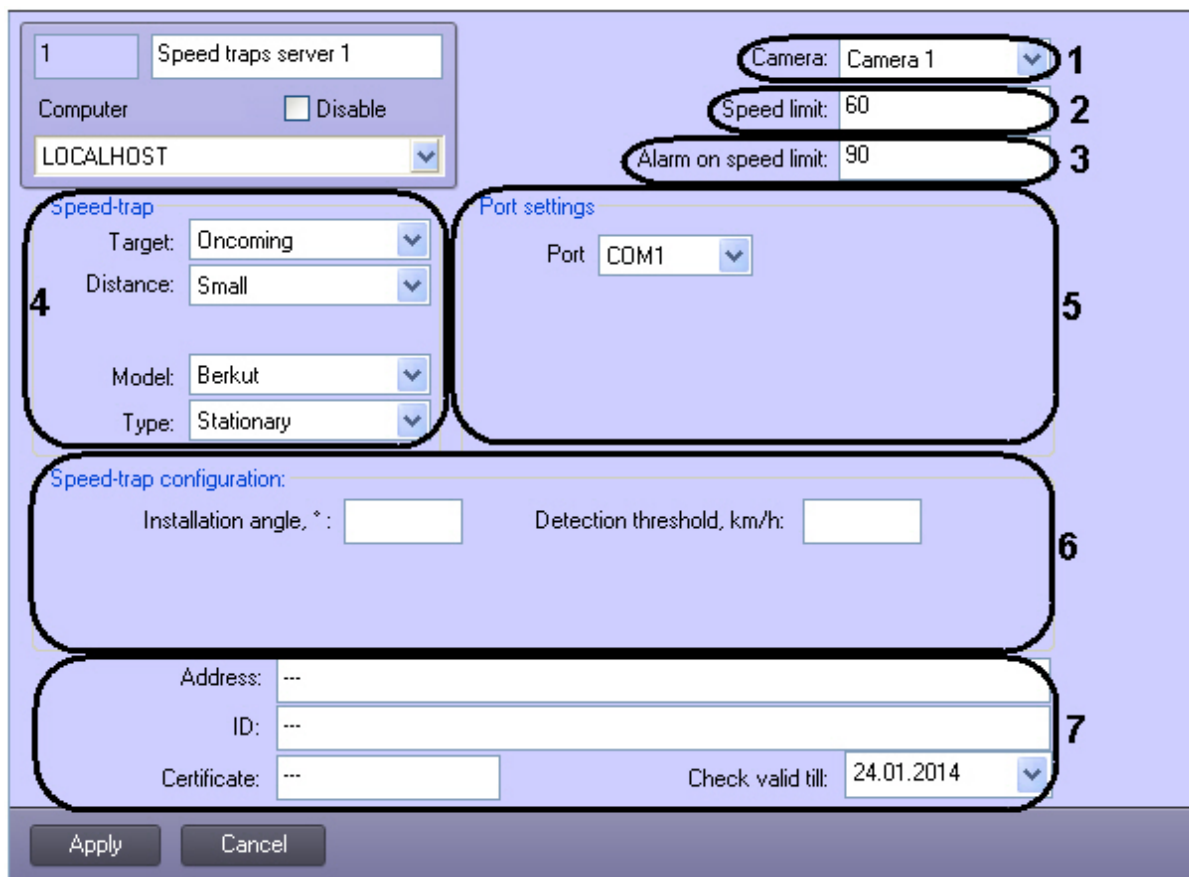

The following table shows the elements in the **Speed traps server** settings panel.

	Parameter name	Field type	Description	Data type	Default value	Value range
1	Camera	List	Selecting the camera to work together with the Auto-Urgan module	List of available Camera objects	Not specified	Depending on the number of available Camera objects
2	Speed limit	Enter the value in the field	Entering the permitted vehicle speed on the controlled area for displaying in the report concerning the recognized number.	Km/h	-	Unlimited
3	Alarm on speed limit	Text field	Entering the maximum allowed vehicle speed the exceeding of which leads to the alarm registration	Km/h	-	Unlimited
Speed-trap group						
4	Target	List	Driving direction of the vehicle to be recognized	List of available directions	Oncoming	Oncoming – vehicles driving toward the speed-trap Passing – vehicles driving away from the speed-trap

	Parameter name	Field type	Description	Data type	Default value	Value range
	Distance	List	Setting an approximate distance between the speed-trap and the vehicles to be recognized	List of available distances	Small	Small Medium Large
	Model	List	Selecting the speed-trap model	List of integrated speed-trap devices	-	Berkut Iskra-1 Iskra-1B Iskra-1D Iskra-1KRIS Python Radis Rapira Rapira 2M Rapira 2M-A Rapira 2M-ART
	Type	List	Specifying the type of the speed-trap installation	List of installation parameters of the speed-trap devices	Stationary	Stationary – the speed-trap is static Moving – the speed-trap is installed on the moving vehicle
Port settings group						
5	Port	List	COM-port number	List of available COM-ports	COM1	Depending on the system configuration
Speed-trap configuration group						
6	Installation angle, *	Text field	The angle of the speed-trap installation in relation to the horizon	Degrees	Not specified	0 - 360
	Detection threshold, km/h	Text field	Minimum speed detectable by the speed-trap	Km/h	Not specified	Unlimited
7	Address	Enter the value in the field	Set the address of speed-trap position	-	-	-
	ID	Enter the value in the field	Set the factory ID number of speed-trap device	-	-	Depends on the producer of the device
	Certificate	Enter the value in the field	Set the number of the certificate, corresponding to speed-trap device	Number	-	-
	Checking valid till	Select from the list (calendar is used)	Set the date until which verification is valid	Date in format: dd, mm, yy	Current date	-

6.1.6 The Traffic Detection object settings panel

The figure shows the **Traffic Detection** object settings panel.



The following table describes the elements of the **Traffic Detection** object settings panel.

	Parameter name	Parameter value setting method	Description	Data type	Default value	Value range
1	Select cameras group					
	Select cameras drop-down list	Select the value from the list	Selecting the camera for Traffic Detection	List of available Camera objects	Not specified	Depending on the number of available Camera objects
2	Archive parameters group					
	Archive size, days field	Enter value in the text field	Storage depth of the database archive	Days	30	1 - 60
	Statistics update time, HH:MM:SS field	Enter value in the text field	Time period for updating the current data statistics	HH:MM:SS	00:15:00	00:10:00 - 23:59:59

	Parameter name	Parameter value setting method	Description	Data type	Default value	Value range
	Statistics update period, HH:MM:SS field	Enter value in the text field	Time period for the current data statistics display	HH:MM:SS	01:00:00	00:10:00 - 23:59:59
3	Advanced settings group					
	Marking setup button	Click the button	Setting up the markings parameters	-	-	-
	Speed-trap setup button	Click the button	Setting up of the Radar module to work together with Traffic Detection	-	-	-
4	Traffic jam detection group					
	Beginning time, s field	Enter value in the text field	Setting up the time period to detect the start of the jam	Seconds	15	1 - 60
	Ending time, s field	Enter value in the text field	Setting up the time period to detect the end of the jam	Seconds	20	1 - 60
	Average speed threshold, km/h field	Enter value in the text field	Setting up the speed threshold to detect a jam	Km/h	30	1 - 255
	Traffic jam threshold, % field	Enter value in the text field	Setting up the road load threshold to detect a jam	Percent	30	1 - 100
5	Threshold values group					
	Speed limit, km/h field	Enter value in the text field	Maximum allowed vehicle speed	Km/h	60	1 - 255
	Traffic jam threshold, % field	Enter value in the text field	Setting up the maximum road load	Percent	30	1 - 100
6	Directions group					
	Movement from camera field	Enter value in the text field	Setting the display text for movement away from the camera	Latin, Cyrillic and special symbols	Movement away from camera	Case-insensitive character string, 1 to 256 symbols
	Movement towards camera field	Enter value in the text field	Setting the display text for movement toward the camera	Latin, Cyrillic and special symbols	Movement toward camera	Case-insensitive character string, 1 to 256 symbols

	Parameter name	Parameter value setting method	Description	Data type	Default value	Value range
7	Events group					
	Available list	Add value to the list	The list of all available events in Traffic Detection	List of events	All events	Depending on the number of available events
	Selected list	Add value to the list	The list of events used in Traffic Detection	List of events	Not specified	Depending on the number of available events
	Add (>)	Click the button	Add selected events from the Available events field to the Selected events list	-	-	-
	Add all (>>)	Click the button	Add all events from the Available events field to the Selected events list	-	-	-
	Remove (<)	Click the button	Remove selected events from the Selected events list	-	-	-
	Remove all (<<)	Click the button	Remove all events from the Selected events list	-	-	-

6.1.7 The Traffic Monitor object settings panel

The **Traffic Monitor** interface object is designed for creation and setting up of the window for displaying the textual information about the characteristics of the traffic.

The **Traffic Monitor** object settings panel includes the following interface elements:

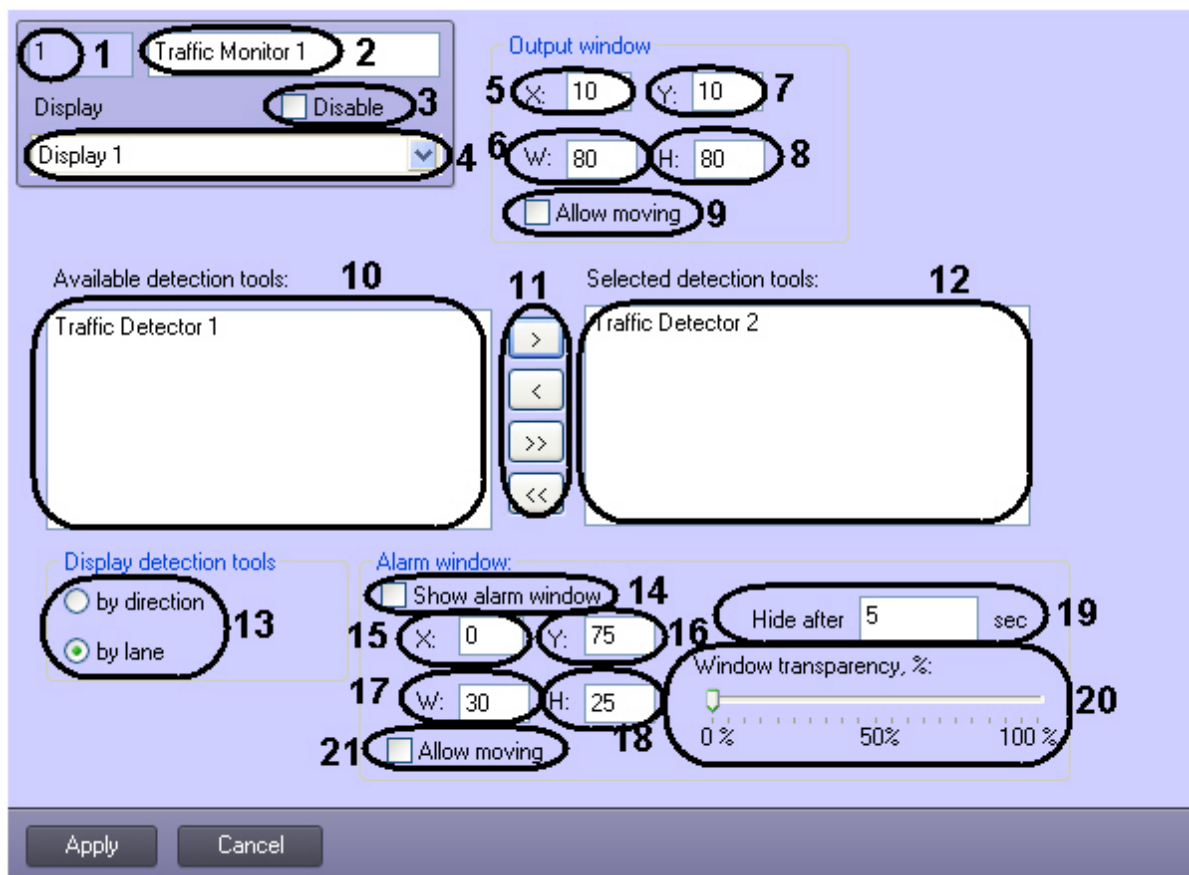

The following table describes the elements of the **Traffic Monitor** object settings panel.

	Parameter name	Field type	Description	Data type	Default value	Value range
1	ID*	Auto	The ID of the object in the video surveillance system.	Number	-	1 and higher Depends on the number of Traffic monitor objects.
2	Name*	Text field	The name of the object in the video surveillance system	Latin, Cyrillic and special symbols	Traffic monitor	Case-insensitive character string, 1 to 60 symbols.
3	Disable	Checkbox	Setting up of the object state	Boolean	No	Yes – Traffic monitor object is not used in the system No – Traffic monitor object is used and active.
4	Screen	List	Selecting the parent Screen object to link Traffic Monitor to.	Screen object names	Parent Screen name	Depends on the number of Screen objects.
Coordinates group						
5	X	Text field	X coordinate of the upper left corner of the window	% of screen width	Not specified	0 to M*100, where M is the number of surveillance monitors

	Parameter name	Field type	Description	Data type	Default value	Value range
6	Y	Text field	Y coordinate of the upper left corner of the window	% of the screen height	Not specified	0 to M*100, where M is the number of surveillance monitors
7	W	Text field	Window width	% of screen width	Not specified	0 to M*100, where M is the number of surveillance monitors
8	H	Text field	Window height	% of the screen height	Not specified	0 to M*100, where M is the number of surveillance monitors
9	Allow moving	Checkbox	Allows moving the LPR Viewer window across the screen	Boolean	No	Yes – moving allowed No – moving not allowed
Available detection tools – Selected detection tools						
10	Available detection tools:	List	The system automatically generates the list	List of detection tools	List of detected recognizers	List of detection tools
11	Add (>)	Button	Adding selected items from the Available detection tools list to the Selected detection tools list	-	-	-
11	Remove (<)	Button	Removing selected items from the Selected detection tools list	-	-	-
11	Add all (>>)	Button	Adding all items from the Available detection tools list to the Selected detection tools list	-	-	-
11	Remove all (<<)	Button	Removing all items from the Selected detection tools list	-	-	-
12	Selected detection tools:	List	List of recognizers selected from the Available detection tools list	List of detection tools	Not specified	List of detection tools
Display detection tools group						
13	By lane By direction	Radio-button	Selecting the way the detectors are displayed, by lane or by direction	Boolean	By lane	By lane By direction
Alarm window						
14	Show Alarm window	Checkbox	Enable the alarm window display	Boolean	No	Yes – display the alarm window No – do not display the alarm window

	Parameter name	Field type	Description	Data type	Default value	Value range
1 5	X	Text field	X coordinate of the upper left corner of the Alarm window	% of the screen width	Not specified	0 to M*100, where M is the number of surveillance monitors
1 6	Y	Text field	Y coordinate of the upper left corner of the Alarm window	% of the screen height	Not specified	0 to M*100, where M is the number of surveillance monitors
1 7	W	Text field	Alarm window width	% of the screen width	Not specified	0 to M*100, where M is the number of surveillance monitors
1 8	H	Text field	Alarm window height	% of the screen height	Not specified	0 to M*100, where M is the number of surveillance monitors
1 9	Hide after	Text field	Specifying the time to display the Alarm window for	Seconds	Not specified	0 to 59
2 0	Window transparency	Slider	Setting up the Alarm window transparency	%	0	0 to 100 0 relates to the opaque window 100 relates to the transparent window
2 1	Allow moving	Checkbox	Enable the moving of the Alarm window across the screen	Boolean	No	Yes – moving allowed No – moving not allowed

*The element name is not displayed in the settings panel.

6.1.8 TheTraffic violations detection module object settings panel

The **Traffic violations detection** module object settings panel contains the following interface elements:

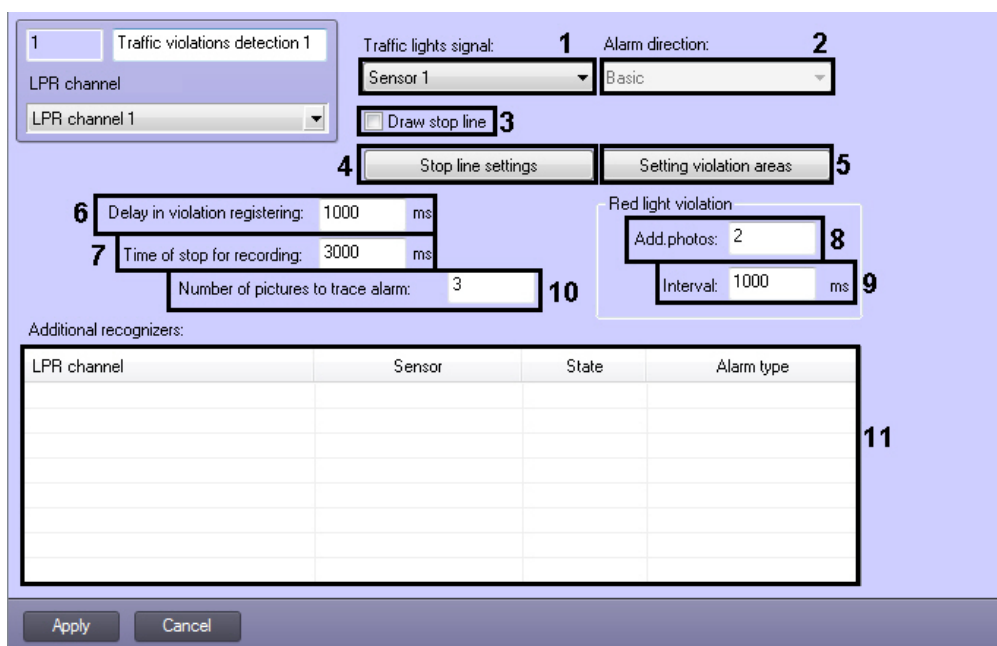

The following table describes the elements of the **Traffic violations detection** object settings panel.

No	Parameter name	Parameter setting method	Description	Data type	Default value	Value range
1	Traffic lights signal dropdown list	Selecting the value in the list	Selecting «Sensor/Detector» object, by signal of which traffic light is detected	List of accessible «Sensor/Detector» objects	no	Depending on number of accessible «Sensor/Detector» objects
2	Alarm direction dropdown list	Selecting the value in the list	Selecting the signal of traffic light detection on which the traffic violations detection is to be responded	List of accessible directions	Basic	Basic - use the basic signal of the traffic light Left - use the left arrow of the traffic light Right - use the right arrow of the traffic light
3	Draw a stop line checkbox	Setting check box	Draw a stop line on video in front of traffic light function activation	Boolean type	no	Yes – drawing a stop line function is active No – drawing a stop line function is off
4	Stop line settings button	Clicking	Access to stop line settings	-	-	-
5	Setting violation areas button	Clicking	Access to stop line settings	-	-	-
6	Delay in violation registering field	Setting the value in the field	Set period after which the running a red light or stop will be considered as a violation	Millisecond	1000	0-99999
7	Time of stop for recording field	Setting the value in the field	Set period that determines the time interval during which the vehicle should stay still while registering the Stop over crosswalk line violation	Millisecond	3000	0-99999
8	Add.photos: field	Setting the value in the field	Set the number of photos made before the licence plate fixing and after its going out the control zone	Whole nonnegative number	2	0-99
9	Interval: field	Setting the value in the field	Set period that determines the time interval between saving additional photos	Millisecond	1000	0-99999
10	Number of pictures to trace alarm: field	Setting the value in the field	Specifying number of photos which will be stored from the moment of LP recognizing on the base recognizer to the moment of LP recognizing on the additional recognizer	Whole nonnegative number	3	0-99
Additional recognizers table						
11	LPR channel column	Selecting the value in the field	Selecting the additional LPR channel if it's required to use additional recognizers along with the base recognizer	List of accessible "LPR channel" objects	-	Depending on number of accessible LPR channel objects
	Sensor column	Selecting the value in the field	Selecting sensor from which events about traffic light operation will be received	List of accessible "Sensor" objects	-	Depending on number of accessible Sensor objects

No	Parameter name	Parameter setting method	Description	Data type	Default value	Value range
	State column	Selecting the value in the field	Selecting event from the sensor on which violation will be fixed	-	-	Active (on) – sensor is closed Normal (off) – sensor is opened
	Alarm type column	Selecting the value in the field	Selecting type of violation which will be fixed in result of joint operation of additional and base recognizers	-	-	Marking violation Red light violation

6.1.9 The Vehicle processor settings panel

The **Vehicle processor** object settings panel includes the following interface elements:

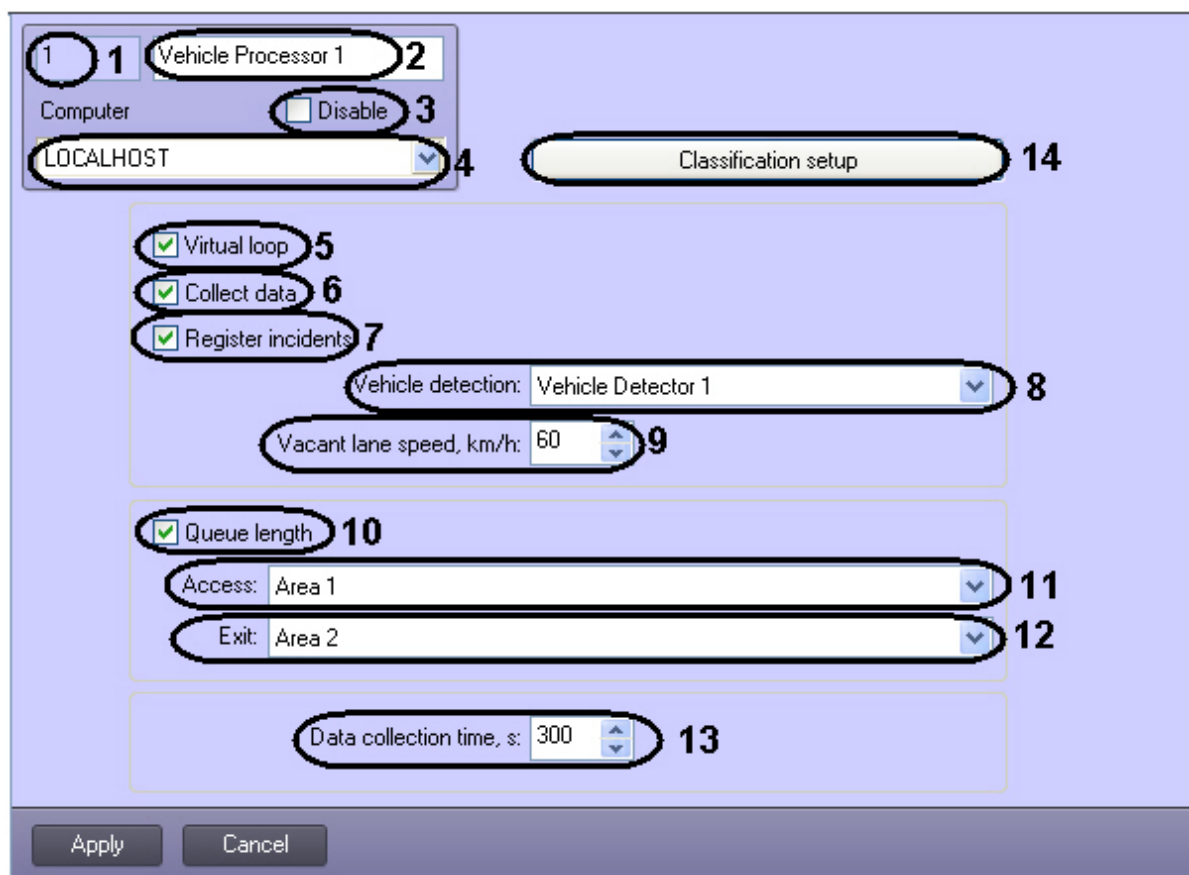

The following table describes the elements of the **Vehicle processor** object settings panel.

No	Parameter name	Parameter setting method	Description	Data type	Default value	Value range
1	ID	Automatically	Displays Vehicle processor object's ID in the system	Numbers	-	From 1 and above. Depends on the Vehicle processor objects number in the system

No	Parameter name	Parameter setting method	Description	Data type	Default value	Value range
2	Name	Enter the value in the field	Set the object's name Vehicle processor in the system	Latin, Cyrillic and special symbols	Vehicle's processor	A sting, containing a sequence of characters (letters, digits, characters)non case-sensitive Number of characters if from 1 to 60.
3	Disable	Is set by a checkbox	Set the Vehicle processor object state(enabled or disabled)in the system	Boolean type	No	Yes- «Vehicle processor» object is disabled and is not in use No -Vehicle processor object is enabled and in use
4	Computer	Select the value from the list	Se the Computer parent object in the system, to which Vehicle processor object is related	Names of objects, registered in the system Computer	Name of the parent object Computer	Depends on the objects number Computer in the system
5	Virtual loop	Is set by a checkbox	Enables the mode that is resulted in retranslation of messages about vehicle's passing in or out of the detection zone.	Boolean type	No	Yes- Virtual loop imitation mode is enabled No - Virtual loop imitation mode is disabled
6	Collect data	Is set by a checkbox	Enables the mode that is resulted in traffic data acquisition and storing them to the database	Boolean type	No	Yes- traffic data acquisition mode is enabled No - traffic data acquisition mode is disabled
7	Register incidents	Is set by a checkbox	Enables the mode that is resulted in accidents fixation in the traffic stream	Boolean type	No	Yes- accidents fixation mode is enabled No - accidents fixation mode is disabled
8	Vehicle detection:	Select the value from the list	Set the module Vehicle detector which data have to be processed	Names of objects, registered in the system Vehicle detector	-	Depends on the Vehicle detector objects number, registered in the system
9	Vacant lane speed, km/h	Enter the value in the field	Set the Free stream speed constant which is to be entered in the database in case when at least 5 vehicles have entered the detection zone for the data acquisition time	Number Speed in km/h	-	From 0 to 200
10	Queue length	Is set by a checkbox	Enables the mode, which results in determining the Length of turn	Boolean type	No	Yes- determining the Length of turn mode is enabled No - determining the Length of turn mode is disabled
11	Access	Select the value from the list	Set the region object corresponding to the area, located at the entrance area to the detection zone	Names of Region objects, registered in the system	-	Depends on the Region objects number, registered in the system

No	Parameter name	Parameter setting method	Description	Data type	Default value	Value range
1 2	Exit	Select the value from the list	Set the region object corresponding to the area, located at the exit area from the detection zone	Names of Region objects, registered in the system	-	Depends on the Region objects number, registered in the system
1 3	Data collection time	Enter the value in the field	Set the Data acquisition time, coming from vehicle detector module. Upon the end of this time validity the data are stored in the database	Number Time in seconds	-	From 60 to 3600
1 4	Classification setup	Press the button	Access to Classification settings of detected vehicles	-	-	-

6.1.10 The Vehicle Tracer object settings panel

The following table describes the elements of the **Vehicle Tracer** object settings panel.

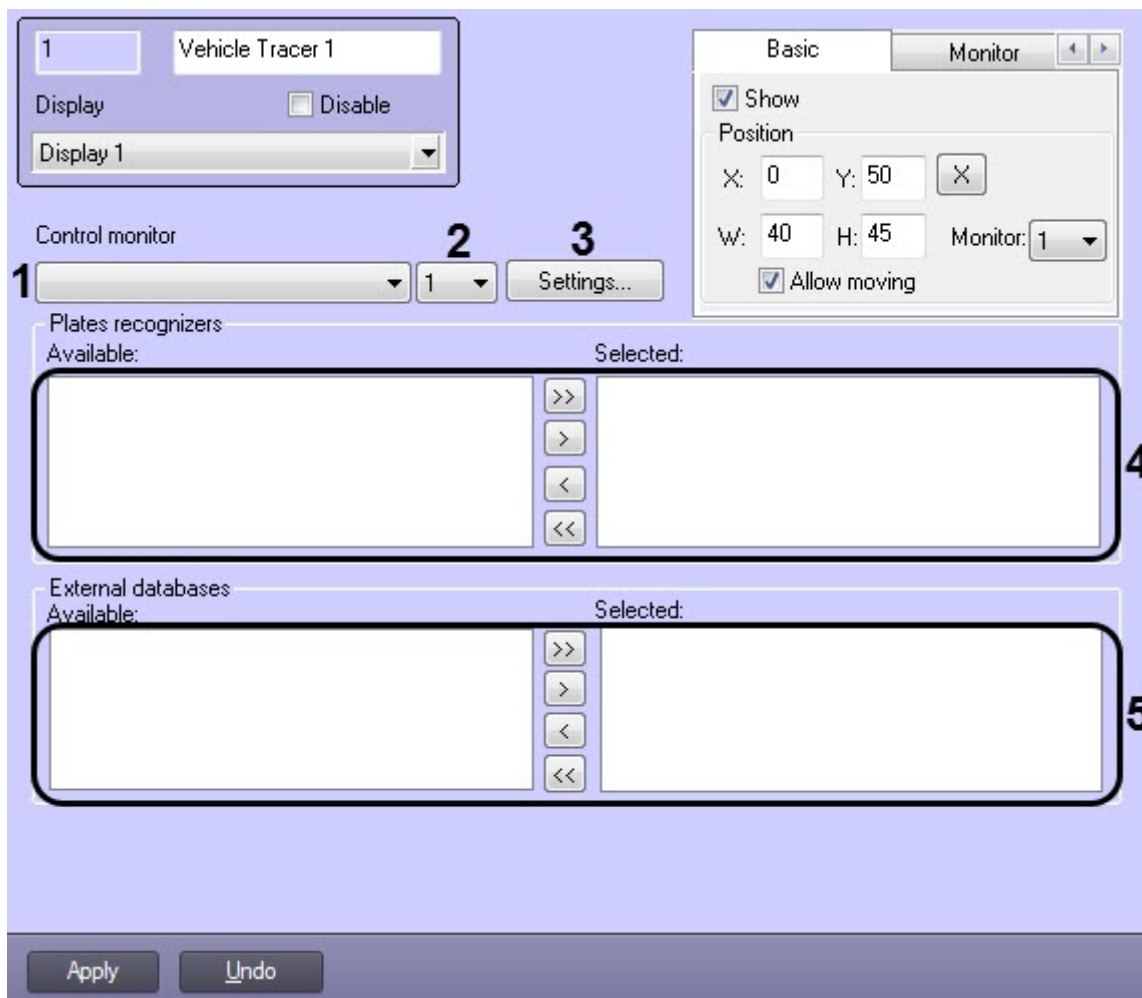

No	Parameter name	Parameter setting method	Description	Data type	Default value	Value range
1	Control monitor	Select from the list	Set the Monitor interface object to play back the video archive from the LP recognition camera upon the command from the Vehicle Tracer window	Names of Monitor objects, registered in the system	-	Depends on the number of Monitor objects, registered in the system
3	Settings	Click the button	Access to The Vehicle Tracer interface and also to the voice notification settings while registering the alarms: overspeeding, identification of the plate in the external database	-	-	-
Plates recognizers group						
4	Available	Automatically	Displays the list of LP recognizers servers, available for displaying in the Vehicle Tracer interface window	-	-	-
	Selected	Automatically	Displays the list of LP recognizers servers, displayed in the Vehicle Tracer interface window	-	-	-
	Buttons >, <, >>, <<	Click the button	Selection of LP recognizers servers, to be displayed in the Vehicle Tracer interface window	-	-	-
External databases group						
5	Available	Automatically	Displays the list of External Plates databases, that may be used for the identified objects analysis	-	-	-
	Selected	Automatically	Displays the list of External Plates databases, selected for the identified objects analysis	-	-	-
	Buttons >, <, >>, <<	Click the button	Selection of Plates databases for the identified objects analysis	-	-	-

The **Basic** tab:

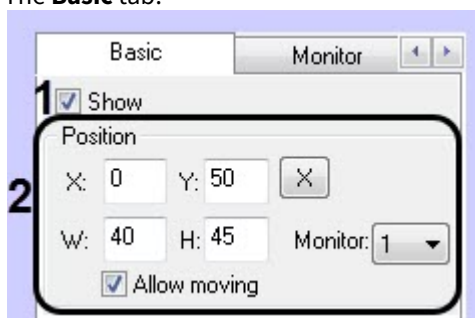

No	Parameter name	Parameter setting method	Description	Data type	Default value	Value range
1	Show	Is set with a checkbox	Displays the Active monitor component on the screen	Boolean type	No	Yes – Active monitor components is displayed on the screen No – Active monitor components is not displayed on the screen
Coordinates group on the Basic tab						
2	Field X	Enter the value in the field	Set the horizontal coordinate of the X axis of the Active monitor's component left upper corner on the screen	% regarding the screen's width	-	From 0 to M*100, where M – is the number of installed video surveillance monitors
	Field Y	Enter the value in the field	Set the vertical coordinate of the Y axis of the Active monitor's component left upper corner on the screen	% regarding the screen's height	-	From 0 to M*100, where M – is the number of installed video surveillance monitors
	Field W	Enter the value in the field	Set the width of the Active monitor's component	% regarding the screen's width	-	From 70 to M*100, where M – is the number of installed video surveillance monitors
	Field H	Enter the value in the field	Set the height of the Active monitor's component	% regarding the screen's height	-	From 39 to M*100, where M – is the number of installed video surveillance monitors
	Button X	Click the button	Entering the text window for visual setting the coordinates and sizes of the Active monitor's component	-	-	-
	Allow moving	Is set with a checkbox	Enables moving the Active monitor's component	Boolean type	No	Yes – moving is permitted No – moving is unavailable

The **Monitor** tab:

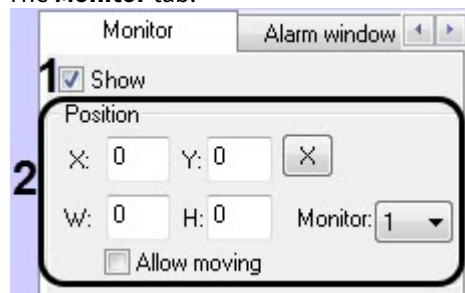

No	Parameter name	Parameter setting method	Description	Data type	Default value	Value range
1	Show	Is set with a checkbox	Displays the Events monitor component on the screen	Boolean type	No	Yes – the Events monitor component is displayed on the screen No – the Events monitor component is not displayed on the screen

Coordinates group on the **Monitor** tab

2	Field X	Enter the value in the field	Set the horizontal coordinate of the X axis of the Events monitor's component left upper corner on the screen	% regarding the screen's width	-	From 0 to M*100, where M – is the number of installed video surveillance monitors
	Field Y	Enter the value in the field	Set the vertical coordinate of the Y axis of the Events monitor's component left upper corner on the screen	% regarding the screen's height	-	From 0 to M*100, where M – is the number of installed video surveillance monitors
	Field W	Enter the value in the field	Set the width of the Events monitor's component	% regarding the screen's width	-	From 0 to M*100, where M – is the number of installed video surveillance monitors
	Field H	Enter the value in the field	Set the height of the Active monitor's component	% regarding the screen's height	-	From 0 to M*100, where M – is the number of installed video surveillance monitors
	Button X	Click the button	Entering the text window for visual setting the coordinates and sizes of the Events monitor's component	-	-	-
	Allow moving	Is set with a checkbox	Set the possibility of moving the Events monitor's component	Boolean type	No	Yes – moving is permitted No – moving is unavailable

The **Alarm window** tab:



No	Parameter name	Parameter setting method	Description	Data type	Default value	Value range
1	Show	Is set with a checkbox	Displays the Alarm window component on the screen	Boolean type	No	Yes – the Alarm window component is displayed on the screen No – the Alarm window component is not displayed on the screen

No	Parameter name	Parameter setting method	Description	Data type	Default value	Value range
Coordinates group on the Alarm window tab						
2	Field X	Enter the value in the field	Set the horizontal coordinate of the X axis of the Active monitor's component left upper corner on the screen	% regarding the screen's width	-	From 0 to M*100, where M – is the number of installed video surveillance monitors
	Field Y	Enter the value in the field	Set the vertical coordinate of the Y axis of the Active monitor's component left upper corner on the screen	% regarding the screen's height	-	From 0 to M*100, where M – is the number of installed video surveillance monitors
	Field W	Enter the value in the field	Set the width of the Active monitor's component	% regarding the screen's width	-	From 70 to M*100, where M – is the number of installed video surveillance monitors
	Field H	Enter the value in the field	Set the height of the Active monitor's component	% regarding the screen's height	-	From 39 to M*100, where M – is the number of installed video surveillance monitors
	Button X	Click the button	Entering the text window for visual setting the coordinates and sizes of the Active monitor's component	-	-	-
	Allow moving	Is set with a checkbox	Enables moving the Alarm window's component	Boolean type	No	Yes – moving is permitted No – moving is unavailable

6.1.11 The ARENA module object settings panel

The **ARENA** module object settings panel contains the following interface elements:

The following table describes the elements of the **ARENA Module** object settings panel.

No	Parameter name	Parameter setting method	Description	Data type	Default value	Value range
1	IP address field	Setting the value in the field	Set IP address of network device	Natural number series	127.0.0.1	Expression: xxx.xxx.xxx.xxx. consists values from 0.0.0.0 to 255.255.255.255 depending on network settings that are registered in IP devices system.
2	FTP port field	Setting the value in the field	Set connecting port to FTP-server	Whole nonnegative number	21	Depending on system configuration
3	TCP/IP port field	Setting the value in the field	Set connecting port to FTP-server	Whole nonnegative number	6408	Depending on system configuration
4	Login field	Setting the value in the field	Set user name for connecting to FTP-server	Roman alphabet Cyrillic alphabet and service digits	anonymous	Line consisting sequence of any symbols (letters, figures, service digits) taking into account register. Number of symbols is from 1 to 60.
5	Password field	Setting the value in the field	Set user password that is used for connecting to FTP-server	Roman alphabet Cyrillic alphabet and service digits	anonymous	Line consisting sequence of any symbols (letters, figures, service digits) taking into account register. Number of symbols is from 1 to 60.

No	Parameter name	Parameter setting method	Description	Data type	Default value	Value range
6	Frames polling interval, ms field	Setting the value in the field	Set time between two logical queries in Auto Intellect PC for downloading photos from Arena	Millisecond	1000	0-20000
7	Alarm on speed limit field	Setting the value in the field	Setting maximum allowed vehicle rate of movement	Km/h	80	No restrictions

6.1.12 The ARH-Railway module object settings panel

The **ARH-Railway module** object settings panel contains the following interface elements.

The **Main settings** tab:

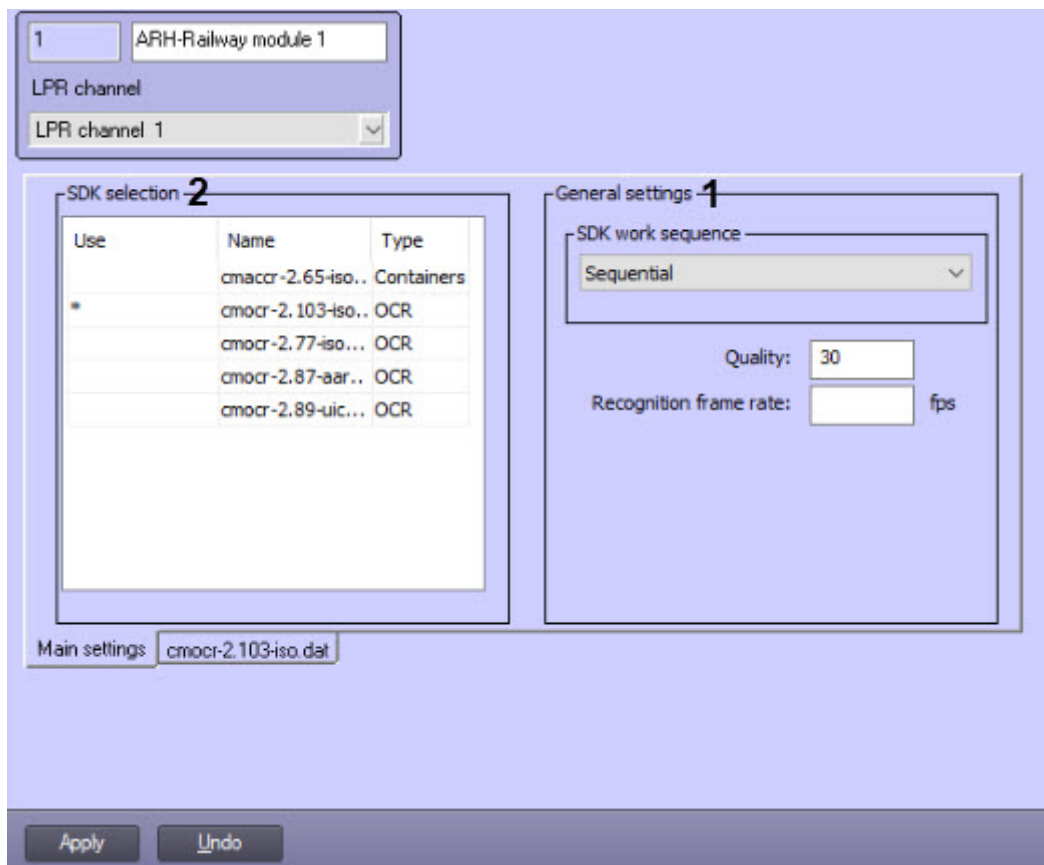

The following table describes the elements of the **ARH-Railway** module object settings panel.

No	Parameter name	Parameter setting method	Description	Data type	Default value	Value range
1	The General settings group					
	SDK work sequence	Select the value from the list	Sets the work sequence of SDKs	-	Sequential	Sequential —the SDKs work sequentially Parallel —the SDKs work in parallel

No	Parameter name	Parameter setting method	Description	Data type	Default value	Value range
	Quality	Enter the value in the text field	Sets the image quality of the carriage numbers, starting from which the numbers will be recognized. The value is determined experimentally	Percent	60	>=0
	Recognition frame rate, fps	Enter the value in the text field	Sets the number of the frames per second processed by the recognizer. If you enter 0 or leave the field blank, the recognizer will process the maximum possible number of frames	FPS	-	>=0
2	The SDK selection table					
	Us	Click the mouse button	Determines if the corresponding SDK is going to be used for recognition	List	-	-
	Name	Automatically	The SDK name	List	-	-
	Type	Automatically	The SDK type of recognition	List	-	-

The SDK tab:

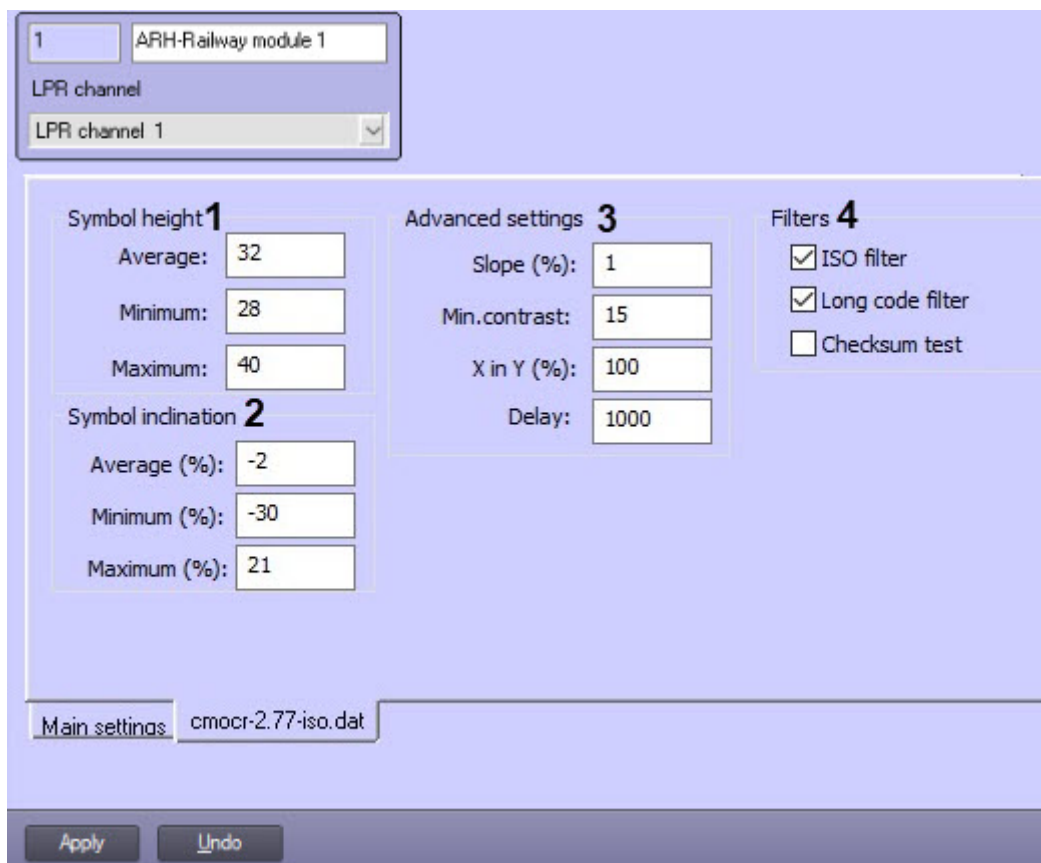

No	Parameter name	Parameter setting method	Description	Data type	Default value	Value range
1	The Symbol height group					

No	Parameter name	Parameter setting method	Description	Data type	Default value	Value range
	Minimum	Enter the value in the text field	Sets the minimum height of the carriage number symbol in the video image from the camera	Pixels	28	≥ 0
	Average	Enter the value in the text field	Sets the average height of the carriage number symbol in the video image from the camera	Pixels	32	≥ 0
	Maximum	Enter the value in the text field	Sets the maximum height of the carriage number symbol in the video image from the camera	Pixels	40	≥ 0
2	The Symbol inclination group					
	Average (%)	Enter the value in the text field	Sets the average inclination of the symbol. The value is positive if the horizontal axis of the LP symbols is tilted down when viewed from left to right, and negative if this axis is tilted up	Percent	-2	≤ 0
	Minimum (%)	Enter the value in the text field	Sets the minimum inclination of the symbol. The value is positive if the horizontal axis of the LP symbols is tilted down when viewed from left to right, and negative if this axis is tilted up	Percent	-30	≤ 0
	Maximum (%)	Enter the value in the text field	Sets the maximum inclination of the symbol. The value is positive if the horizontal axis of the LP symbols is tilted down when viewed from left to right, and negative if this axis is tilted up	Percent	21	≤ 0
3	The Advanced settings group					
	Slope (%)	Enter the value in the text field	Sets the slope of the carriage number in relation to the video image received from the camera. The value is positive if the horizontal axis of the LP symbols is tilted down when viewed from left to right, and negative if this axis is tilted up	Percent	1	≤ 0
	Min. contrast	Enter the value in the text field	Sets the estimated difference between the shades of gray of the LP symbols and the background	Shades of gray	15	≥ 0
	X in Y (%)	Enter the value in the text field	Sets the ratio of the horizontal and vertical symbol resolution. The horizontal resolution is the ratio of the symbol width on the video image to its actual width, and the vertical resolution is the ratio of the symbol height on the video image to its real height. If you enter zero or a negative value, then the value will automatically changed to 100	Percent	100	≥ 0

No	Parameter name	Parameter setting method	Description	Data type	Default value	Value range
	Delay	Enter the value in the text field	Sets the time interval in milliseconds that should expire in order for the recognition module to display the next number recognition result. A value of zero means no delay	Milliseconds	1000	>=0
4	The Filters group					
	ISO filter	Set the checkbox	Enables the ISO carriage numbers filtering. When reading a number that consists of 11 symbols, the recognition module will attempt to read the ISO code (examples of ISO codes: GB4310, 22G1)	-	Set	Set—the filtering is enabled Clear—the filtering is disabled
	Long code filter	Set the checkbox	Enables the long numbers filtering. If the video image does not contain the carriage number, but contains some other text, the recognition module can display a false carriage number. The long numbers filtering reduces the likelihood of the false codes appearing, increases the runtime (by about 5%), and degrades the recognition of the carriage codes on the images with a carriage code (by about 0.5%)	-	Set	Set—the filtering is enabled Clear—the filtering is disabled
	Checksum test	Set the checkbox	Enables the testing of the checksum of the numbers	-	Clear	Set—the testing is enabled Clear—the testing is disabled

6.1.13 The AUTO-Uragan module object settings panel

The **AUTO-Uragan** module object settings panel contains the following interface elements:

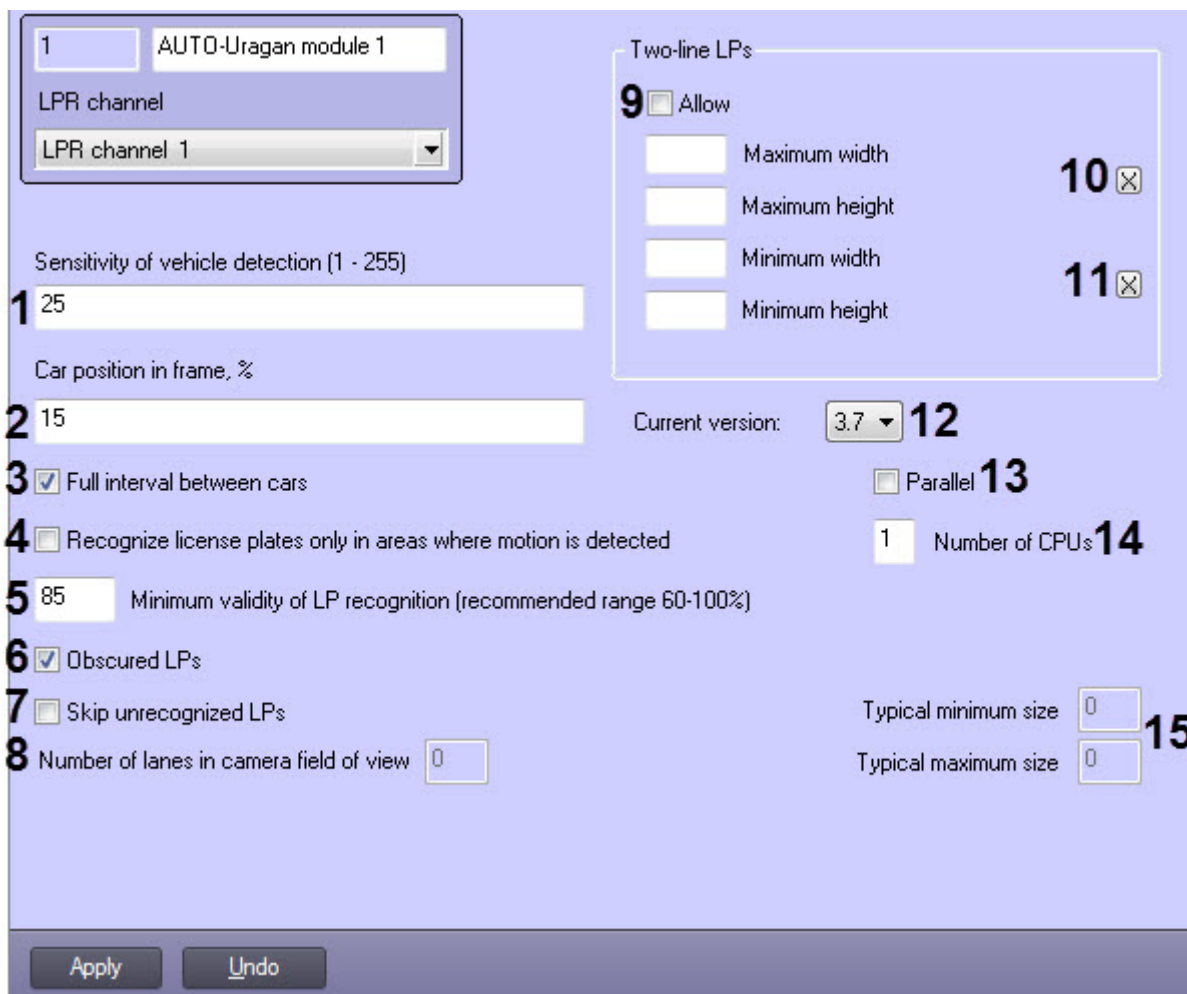

The following table describes the elements of the **AUTO-Uragan** object settings panel.

No	Parameter name	Parameter setting method	Description	Data type	Default value	Value range
1	Sensitivity of vehicle detection (1-255) field	Setting the value in the field	Set detector sensitivity to picture contrast of the car	Lux	25	1-255
2	Car position in frame, % field	Setting the value in the field	Set car position in frame between the moments of car appearance and disappearance from the frame	% regarding the frame	15	0-100
3	Full interval between cars checkbox	Setting check box	Switch recognizer to waiting mode of motion absence all over the frame	Boolean type	No	Yes – recognizer is in waiting mode of motion absence all over the frame. No – recognizer is not in waiting mode of motion absence all over the frame.

No	Parameter name	Parameter setting method	Description	Data type	Default value	Value range
4	Recognize license plates only in areas where motion is detected checkbox	Setting check box	Switch recognizer into the mode in which the plate recognizing is performed only in areas where motions was detected.	Boolean type	No	Yes – recognizer works with those areas where the motion was detected. No – recognizer works with all frame areas
5	Minimum validity of LP recognition (60-100%) field	Setting the value in the field	Set the minimal allowed validity of LP recognition	Integer non-negative number	85	60-100
6	Obscured LPs checkbox	Setting check box	Enable the possibility of obscured LP recognition	Boolean type	No	Yes – recognition of cars with obscured plates is enabled. No – recognition of cars with obscured plates is disabled.
7	Skip unrecognized LPs checkbox	Setting check box	Enable the ignoring of unrecognized LP numbers	Boolean type	No	Yes – unrecognized LP numbers are ignored. No – unrecognized LP numbers are not ignored.
8	Number of lanes in camera field of view	Non-edited field	Displays the number of lanes in camera field of view	Integer non-negative number	-	-
9	Allow	Setting check box	Enable the possibility of two-lines license plates recognizing	Boolean type	No	Yes – two-lines LPs are recognized. No – two-lines LPs are not recognized
10	Maximal width	Setting the value in the field	Maximal width of the two-lines license plates	% regarding the frame	-	Unlimited
	Maximal height	Setting the value in the field	Maximal height of the two-lines license plates	% regarding the frame	-	Unlimited
	Button X	Click the button	Access to the interactive interface of setting the area width and height of two-lines license plates	-	-	-
11	Minimal width	Setting the value in the field	Minimal width of the two-lines license plates	% regarding the frame	-	Unlimited
	Minimal height	Setting the value in the field	Minimal height of the two-lines license plates	% regarding the frame	-	Unlimited
	Button X	Click the button	Access to the interactive interface of setting the area width and height of two-lines license plates	-	-	-
12	Current version	Drop-down list	Select the SDK version which is being used	Selecting the value from the drop-down list	3.7	3.5 3.7

No	Parameter name	Parameter setting method	Description	Data type	Default value	Value range
1 3	Parallel	Setting check box	Enable the LP numbers recognition simultaneously on several processors using parallel computing, which improves the performance of the AUTO-URAGAN module	Boolean type	No	Yes - parallel computing is enabled. No - parallel computing is disabled.
1 4	Number of CPUs	Setting the value in the field	Displays the number of processors which will be used for the parallel computing, if the Parallel checkbox is set	Integer non-negative number	1	>0
1 5	Typical minimum size	Non-edited field	Displays the typical minimum size of license plate	Integer non-negative number	-	-
	Typical maximum size	Non-edited field	Displays the typical maximum size of license plate	Integer non-negative number	-	-

6.1.14 The CARMEN-Auto module object settings panel

CARMEN-Auto module object settings panel contains the following interface elements:

1 CARMEN-Auto module 1

LPR channel

LPR channel 1

Recognition frame rate 3 fps

1 2 Minimum validity of LP type recognition

2 . LP delimiter

Apply Undo

The following table describes the elements of the **CARMEN-Auto module** object settings panel.

No	Parameter name	Parameter setting method	Description	Data type	Default value	Value range
1	Minimum validity of LP type recognition field	Setting the value in the field	Set the minimal allowed validity of LP recognition	Integer non-negative number	2	1-100
2	LP delimiter field	Setting the value in the field	Set delimiter in recognized license plates	-	-	-
3	Recognition frame rate, fps field	Setting the value in the field	Set the number of frames per second processed by the recognizer. If you enter 0 or leave the field empty, the recognizer will process the maximum possible number of frames.	Integer non-negative number	-	>=0

6.1.15 The IntLab Module object settings panel

The **IntLab Module** object settings panel contains the following interface elements:

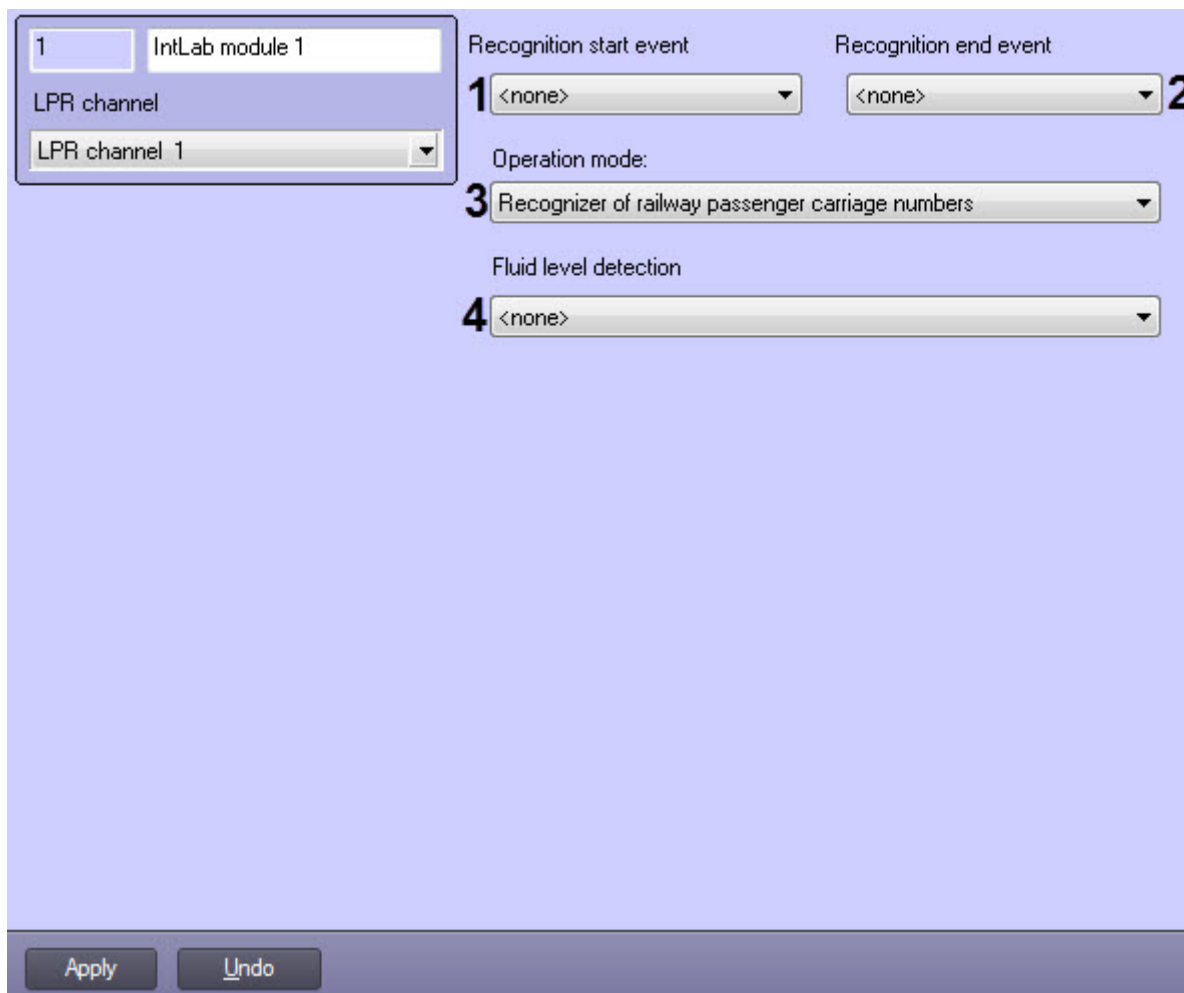

The following table describes the elements of the **IntLab Module** object settings panel.

No	Parameter name	Parameter setting method	Description	Data type	Default value	Value range
1	Recognition start event drop-down list	Selecting the value in the list	Selecting the macro, on which the LP recognition will be started	List of accessible Macro objects	<none>	Depending on number of accessible Macro objects
2	Recognition end event drop-down list	Selecting the value in the list	Selecting the macro, on which the LP recognition will be completed and the result will be given	List of accessible Macro objects	<none>	Depending on number of accessible Macro objects
3	Operation mode drop-down list	Selecting the value in the list	Selecting operation mode used for recognition of numbers	List of accessible operation modes	Recognizer of railway passenger carriage numbers	<p>Recognizer of railway passenger carriage numbers – is used for recognition of railway passenger carriage numbers</p> <p>Recognizer of railway freight carriage numbers – is used for recognition of railway freight carriage numbers</p> <p>Special mode – allows recognition of UIC carriage numbers</p> <p>Railway container number recognizer - is used for recognition of railway container numbers</p>
4	Fluid level detection drop-down list	Selecting the value in the list	Selecting the Fluid level detection object to use with the IntLab module. For details on this detection tool, refer to <i>Detector Pack. User Guide</i> (the most relevant version is available in AxxonSoft documentation repository).	List of accessible Fluid level detection objects	<none>	Depending on number of created Fluid level detection objects

6.1.16 The IntLab subordinate module object settings panel

The **IntLab subordinate module** object settings panel contains the following interface elements:

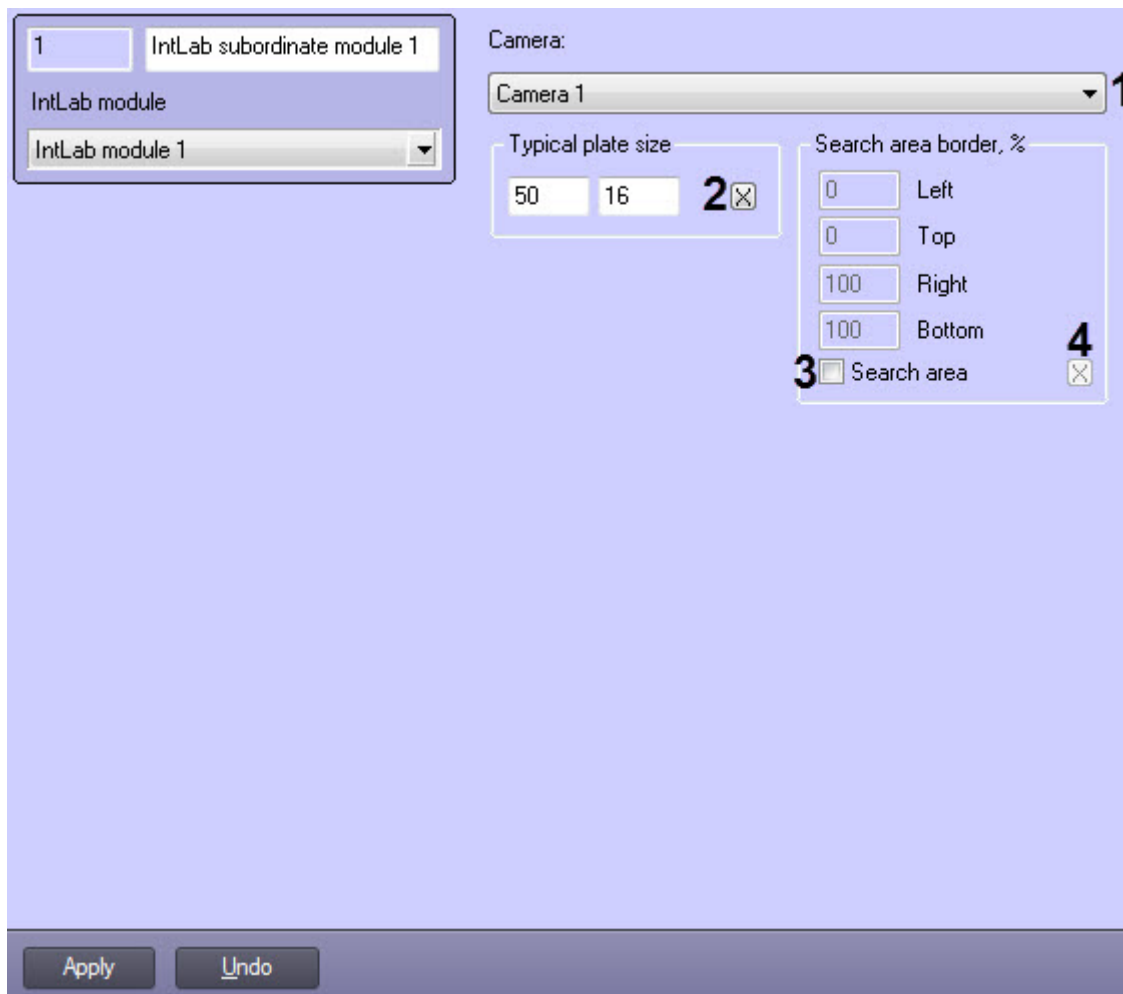

The following table describes the elements of the **IntLab subordinate module** object settings panel.

No	Parameter name	Parameter setting method	Description	Data type	Default value	Value range
1	Camera drop-down list	Selecting the value in the list	Selecting Camera object which will perform the recognition of carriage license plates	List of accessible Camera objects	Camera 1	Depending on number of accessible Camera objects
2	Typical plate size group					
	Length field	Setting the value in the field	Set length of license plate	Whole nonnegative number	50	-
	Height field	Setting the value in the field	Set height of license plate	Whole nonnegative number	16	-
3	Search area border, % group					
	Left field	Setting the value in the field	Left edge of the LP number search area	Percentage of the window width	0	0 - 100
	Top field	Setting the value in the field	Top edge of the LP number search area	Percentage of the window width	0	0 - 100

No	Parameter name	Parameter setting method	Description	Data type	Default value	Value range
	Right field	Setting the value in the field	Right edge of the LP number search area	Percentage of the window width	100	0 - 100
	Bottom field	Setting the value in the field	Bottom edge of the LP number search area	Percentage of the window width	100	0 - 100
	Search area checkbox	Setting checkbox	Enabling the use of the LP number search area boundaries	Boolean	No	Yes – the search area is enabled No – the search area is disabled
4	X	Click the button	Setting the search area using the mouse	-	-	-

6.1.17 The RoadAR module object settings panel

The **RoadAR** module object settings panel contains the following interface elements.

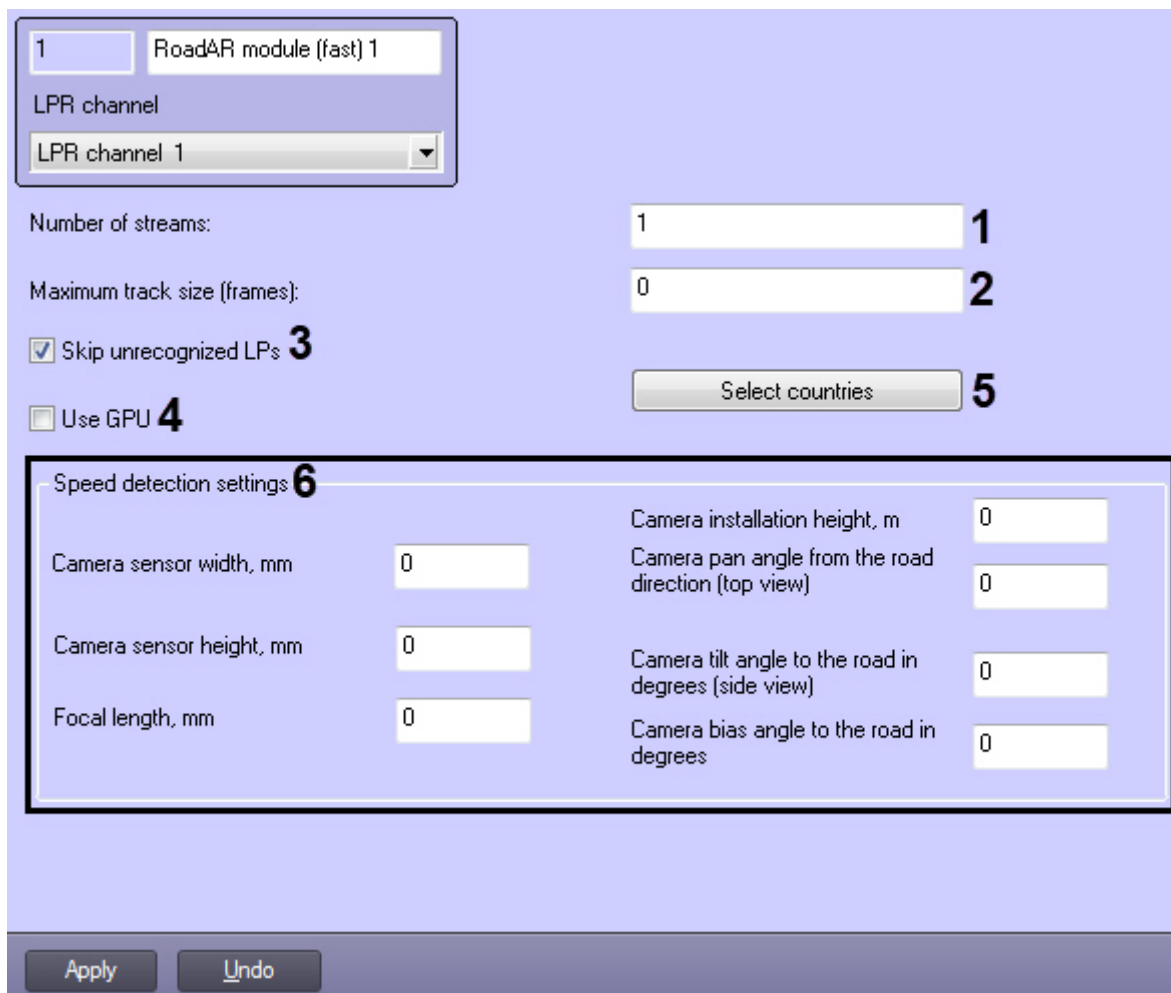

The following table describes the elements of the **RoadAR** module object settings panel.

No	Parameter name	Parameter setting method	Description	Default value	Value range
1	Number of streams field	Enter the value in the text field	Sets the number of streams that the RoadAR SDK will use in parallel computations. A value of 0 disables the calculating process paralleling for the license plate recognition.	0	>=0
2	Maximum track size (frames) field	Enter the value in the text field	Sets the maximum number of frames for one track that will be processed by the RoadAR SDK (the smaller the value, the faster the recognition result will be given, but it will also be less accurate). The default value is 0 - the number of frames is not limited.	0	>=0
3	Skip unrecognized LPs checkbox	Check the box	Enables/disables ignoring the vehicles with unrecognized LP numbers.	Yes	Yes - vehicles with unrecognized license plates are skipped No - vehicles with unrecognized license plates are displayed
4	Use GPU checkbox	Check the box	Enables the use of GPU (graphics processing unit) computing resources to improve the license plate recognition performance	No	Checkbox is set - the GPU computing resources are used to increase the performance of license plate recognition. Checkbox is not set - the CPU (central processing unit) computing resources are used.
5	Select countries button	Click the button	Opens the Country selection window with a list of additional countries whose LP numbers can be recognized	-	-
Speed detection settings group					
6	Camera sensor width, mm field	Enter the value in the text field	Sets the camera sensor width in millimeters	0	>=0
	Camera sensor height, mm field	Enter the value in the text field	Sets the camera sensor height in millimeters	0	>=0
	Focal length, mm field	Enter the value in the text field	Sets the focal length in millimeters	0	>=0
	Camera installation height, m field	Enter the value in the text field	Sets the camera installation height in meters	0	>=0
	Camera pan angle from the road direction (top view) field	Enter the value in the text field	Sets the camera pan angle from the road direction (top view)	0	>=0

No	Parameter name	Parameter setting method	Description	Default value	Value range
	Camera tilt angle to the road in degrees (side view) field	Enter the value in the text field	Sets the camera tilt angle to the road in degrees (side view)	0	>=0
	Camera bias angle to the road in degrees field	Enter the value in the text field	Sets the camera bias angle to the road in degrees	0	>=0

6.1.18 The VIT module object settings panel

The settings panel of the **VIT module** object contains the following interface elements:

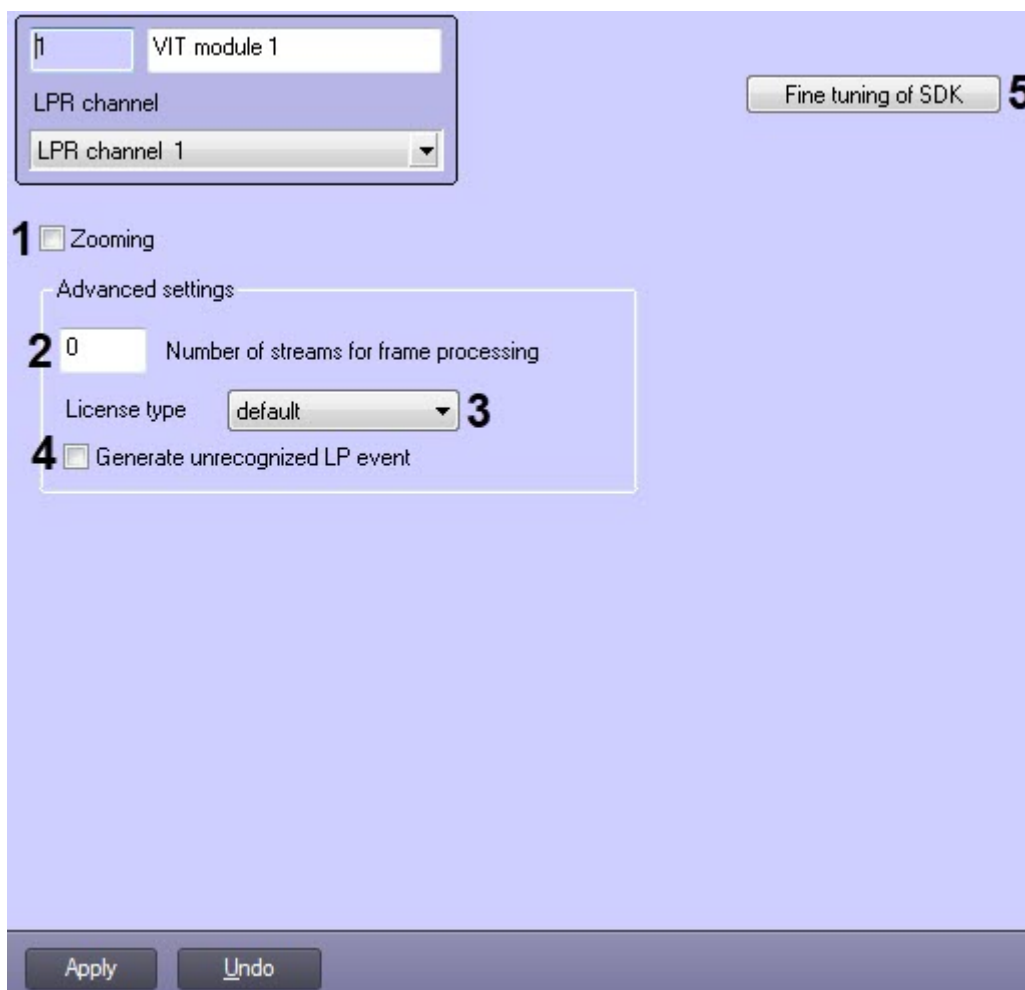

Find the description of the **VIT module** parameters in the table below.

No	Parameter name	Parameter setting method	Description	Data type	Default value	Value range
1	The Zooming checkbox	Set the checkbox	Reduces the frame size while recognizing depending on the Zone width parameter value.	Boolean type	No	Yes – the frame size is reducing while recognizing. No – the frame size is not reducing while recognizing.

No	Parameter name	Parameter setting method	Description	Data type	Default value	Value range
2	The Number of streams for frame processing field	Specify value in the field	Sets maximum recognition streams	Nonnegative integer	0	0-255
3	The License type drop-down list	Select value from the list	Sets the license type used	List of license types	default	default - the license type is determined automatically. fast (25 fps). slow (6 fps).
4	The Generate unrecognized LP event checkbox	Set the checkbox	Enables the generation of the NOT DETECTED event for vehicles whose number could not be recognized	Boolean type	No	Yes - if the license plate is unrecognized, the corresponding event will be generated. No - if the LP is unrecognized, then such a vehicle will be ignored
5	The Fine tuning of SDK button	Click the button	Opens the Fine tuning of SDK (see the table below)	-	-	-

⚠ Important!

**Fine tuning of SDK is to be performed only with the help of AxxonSoft specialists!
It is forbidden to change the values of parameters that are not given in this table.**

Parameter	
VodiCTL_VPW_PLATE_RATIO_TYPE	This parameter sets info on how height reduced or enlarged the incoming image. 1. No distortions 2. Automatically depending on the image size 3. User value
VodiCTL_VPW_IMAGE_THRESHOLD	Base level of image thresholding. By default — 40.
VodiCTL_VPW_IMAGE_BLUR	The parameter for internal use. The recommended value to set is 13.
VodiCTL_VPW_PLATE_EXTRA_ANGLE_ANALYSE	Enable/disable the angle analysis algorithm of the license plate image.
VodiCTL_VPW_PLATE_EXTRA_RANGES_ANALYSE	Enable/disable the algorithm of a thorough search for license plate characters.
VodiCTL_VPW_PLATE_STAR_MAX	Maximum unrecognized symbols on the license plate, at which the result is considered false.
VodiCTL_VPW_PLATE_PROBABILITY_MIN	Minimum percentage of similarity between the recognition result and the original image. Results obtained are filtered according to the authenticity.
VodiCTL_VPW_PLATE_FILTER_ROFACTOR	The license plate filter coefficient by the so-called image density - ratio of the number of pixels to the total number of pixels. Determined by AutoSDK developers using their own test samples. The recommended value is 0.001.
VodiCTL_VPW_PLATE_FILTER_RODROPFACOR	The license plate filter coefficient by the so-called image density - ratio of the number of pixels to the total number of pixels. Determined by AutoSDK developers using their own test samples. The recommended value is 0.001.

VodiCTL_VPW_PLATE_FILTER_SYMCOUNT	Enable/disable the simple license plates filter algorithm by the minimum prospective license plate (geometry, proportions) is performed. If less than that is, the value of this parameter is the minimum characters that must be present.
VodiCTL_VPW_LOG_SETTINGS	Enable/disable logging of all recognition parameters.
VodiCTL_VPW_PLATE_PRECISE_ANALYSE	Enable/disable precise image analysis. It increases the quality of recognition but increases the processing time of the frame by 20-30%, depending on its resolution.
VodiCTL_VPW_DYNAMIC_ENABLE	Enable/disable the number recognition dynamics (by default, the dynamic recognition is disabled). If the value is True , then tracking is enabled, and the number is recognized taking into account the previous ones, and the quality can vary from 0 to 100%.
VodiCTL_VPW_DYNAMIC_OUTPUT_FRAMECOUNT	Number of frames required to display a license plate. The default value is 3. The more frames, the more accurate the license plate in dynamics. The setting is designed to improve authentication.
VodiCTL_VPW_DYNAMIC_WITH_DUPLICATE	Enable/disable the periodic output of license plate recognition results.
VodiCTL_VPW_DYNAMIC_OUTPUT_TIMEOUT	The minimum time required to monitor the license plate (in milliseconds) before the vehicle is monitored, and the user does not immediately receive the results of higher quality and subsequently displayed to the user. If parameter is set to 0, the monitoring of the trajectory of the license plate continues until it disappears.
VodiCTL_VPW_DYNAMIC_OUTPUT_PERIOD	Time period (in milliseconds) over which the recognition result is to be displayed.
VodiCTL_VPW_DYNAMIC_DURATION_WITHOUT_ACCESS	Maximum permissible absence time of the license plate in the monitoring area. If the license plate is not detected for a longer period, the system will output VodiF_RESULT_LOST.
VodiCTL_VPW_DYNAMIC_COMPARABLE_TIME_MAX	Time interval (in milliseconds) that affects the algorithm for comparing license plates. If the license plate size is smaller than the numbers size, then it is considered to be the same object.
VodiCTL_VPW_DNN_DEVICES	A list of devices on which the deep neural network (DNN) computations will be performed. This parameter can also be set via the Windows environment variable: VodiCTL_VPW_DNN_DEVICES.
VodiCTL_VPW_PLATECANDS_METHODS	A variety of methods for obtaining the candidate numbers. Available methods: <ul style="list-style-type: none"> VodiF_VPW_PLATECANDS_BY_MORPH - old method, based on morphological operations. VodiF_VPW_PLATECANDS_BY_DNN - a new method based on deep neural network. To ensure the operation in the VodiF_VPW_PLATECANDS_BY_DNN mode, the license plate image performance will be better. This parameter can also be set via the Windows environment variable: VodiCTL_VPW_PLATECANDS_METHODS.
VodiCTL_VPW_ANALYSE_LEVEL	The level of the number analysis. The following levels of analysis are available: <ul style="list-style-type: none"> VodiK_VPW_TEMPLATE_ANALYSE - the found characters are compared with the template. VodiK_VPW_PLATECANDS_ANALYSE - only candidate numbers are analyzed. VodiK_VPW_SYMCANDS_ANALYSE - the candidate symbols are analyzed.
VodiCTL_VPW_PLATE_ANALYSE_METHODS	A variety of methods for analyzing the candidate numbers. Available methods: <ul style="list-style-type: none"> VodiK_VPW_PLATE_ANALYSE_METHODS_DEFAULT - the default method. VodiF_VPW_BLURAN, VodiF_VPW_NAN, VodiF_VPW_PLATE_ANALYSE_METHODS_DEFAULT - a new number analysis method based on neural network. VodiF_VPW_DNNAN - a new number analysis method based on deep neural network. VodiF_VPW_BLURAN VodiF_VPW_DNNAN VodiF_VPW_TMPLAN methods are available only for license plates.

VodICTL_VPW_PLATE_DNN_FILTER_ENABLE	Enable/disable the candidate numbers filtering by the deep neural network.
VodICTL_VPW_TREAT_PLATECAND_AS_PLATE	Enable/disable the ability to consider each candidate as a number. This candidate will not be lost, but will be given as a number, while some of the other candidates will be lost.
VPW_RECOGN_OUTSIDE_PLATECAND	This Windows environment variable makes it possible to prohibit the analysis of candidates outside the plate and it may be removed later.
VodICTL_VPW_SEQUENTIAL_FLUSH_ENABLE	Enable/disable the ability to change the behavior of the VodiprincFlush (if enabled), accumulated the dynamics results, performed the flush operation. With this parameter, the operation waits for the completion of the analysis of the analyzed, it is necessary to sequentially call the VodiprincFlush operation.
VodICTL_VPW_DYNAMIC_VELOCITY_MAX	System parameters. It is strongly discouraged to change the default values.
VodICTL_VPW_DYNAMIC_COMPARABLE_SYMBOLS_MIN	
VodICTL_VPW_DYNAMIC_BEFORE_LOST_TRACK_TIME_MAX	
VodICTL_VPW_DYNAMIC_AFTER_LOST_TIME_MAX	
VodICTL_VPW_DYNAMIC_AFTER_LOST_FACTOR	
VodICTL_VPW_DYNAMIC_PLATE_LOCATION_MISMATCH_FACTOR	
VodICTL_VPW_DYNAMIC_COMPARABLE_TIME_FACTOR	
VodICTL_VPW_DYNAMIC_PLATE_LOCATION_MISMATCH_FACTOR2	
VodICTL_VPW_DYNAMIC_TRAC_LIMIT	
VodICTL_VPW_DYNAMIC_BEFORE_LOST_TRACK_FACTOR	

6.1.19 The CIDR IntelliVision module object settings panel

The **CIDR IntelliVision module** object settings panel contains the following interface elements.

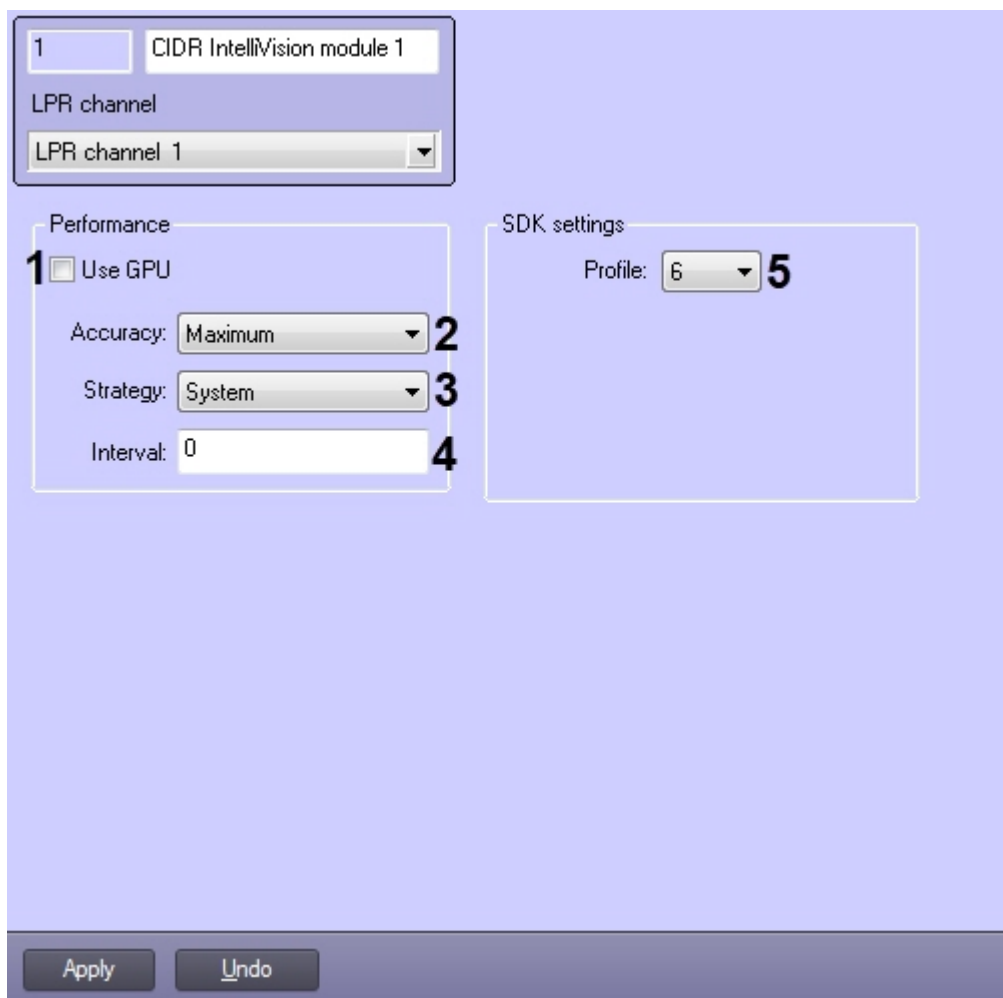

The following table describes the elements of the **CIDR IntelliVision module** object settings panel.

No	Parameter name	Parameter setting method	Description	Data type	Default value	Value range
1	Use GPU checkbox	Check the box	Enables the use of GPU (graphics processing unit) computing resources to improve the license plate recognition performance	-	-	<ul style="list-style-type: none"> • Checkbox is set - the GPU computing resources are used to increase the performance of license plate recognition. • Checkbox is not set - the CPU (central processing unit) computing resources are used.

No	Parameter name	Parameter setting method	Description	Data type	Default value	Value range
2	Accuracy drop-down list	Selecting the value in the list	Selecting the numbers recognition accuracy	List	Maximum	<ol style="list-style-type: none"> 1. Maximum - enables maximum recognition accuracy, but it causes great CPU and/or GPU load. 2. High - enables high recognition accuracy, it requires less computing resources than for maximum accuracy. 3. Fast - enables high recognition speed, but the accuracy becomes worse.
3	Strategy drop-down list	Selecting the value in the list	Selecting the computing resources use mode	List	System	<ol style="list-style-type: none"> 1. Process - mild mode: no more than 1 core for 1 license plate. 2. System - default mode: all available computing cores are in use; 3. Core - strict mode: 1 core per stream.
4	Interval field	Enter the value in the text field	Specifying the minimum time interval lasting between the frames processing (i.e. all frames within this interval will not be processed).	ms	0	In range of 0 to 999
5	Profile drop-down list	Selecting the value in the list	Selecting a license plate recognition quality profile	List	6	6 - Provides high performance (high processing speed and low CPU usage).

6.1.20 The RIDR IntelliVision module object settings panel

The **RIDR IntelliVision module** object settings panel contains the following interface elements.

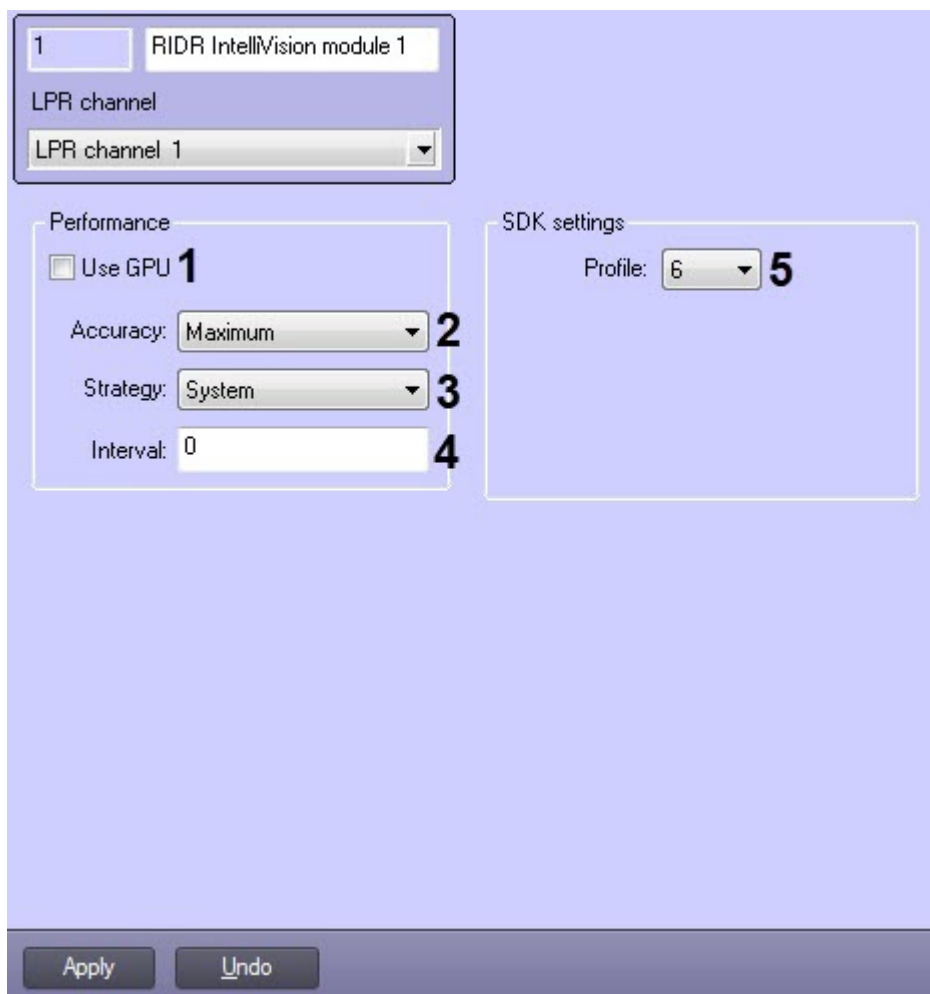

The following table describes the elements of the **RIDR IntelliVision module** object settings panel.

No	Parameter name	Parameter setting method	Description	Data type	Default value	Value range
1	Use GPU checkbox	Check the box	Enables the use of GPU (graphics processing unit) computing resources to improve the license plate recognition performance	-	-	<ul style="list-style-type: none"> • Checkbox is set - the GPU computing resources are used to increase the performance of license plate recognition. • Checkbox is not set - the CPU (central processing unit) computing resources are used.

No	Parameter name	Parameter setting method	Description	Data type	Default value	Value range
2	Accuracy drop-down list	Selecting the value in the list	Selecting the numbers recognition accuracy	List	Maximum	<ol style="list-style-type: none"> 1. Maximum - enables maximum recognition accuracy, but it causes great CPU and/or GPU load. 2. High - enables high recognition accuracy, it requires less computing resources than for maximum accuracy. 3. Fast - enables high recognition speed, but the accuracy becomes worse.
3	Strategy drop-down list	Selecting the value in the list	Selecting the computing resources use mode	List	System	<ol style="list-style-type: none"> 1. Process - mild mode: no more than 1 core for 1 license plate. 2. System - default mode: all available computing cores are in use; 3. Core - strict mode: 1 core per stream.
4	Interval field	Enter the value in the text field	Specifying the minimum time interval lasting between the frames processing (i.e. all frames within this interval will not be processed).	ms	0	In range of 0 to 999
5	Profile drop-down list	Selecting the value in the list	Selecting a license plate recognition quality profile	List	6	<ul style="list-style-type: none"> • 6 - provides higher performance (higher processing speed and less CPU usage) relative to profile 9, but has a lower recognition accuracy. • 9 - provides higher recognition accuracy (works well on noisy and complex scenes) relative to profile 6, but has lower performance (lower processing speed and more CPU consumption).

6.1.21 The LPR IntelliVision module object settings panel

The **LPR IntelliVision module** object settings panel contains the following interface elements.

The following table describes the elements of the **LPR IntelliVision module** object settings panel.

No	Parameter name	Parameter setting method	Description	Data type	Default value	Value range
1	Use GPU checkbox	Check the box	Enables the use of GPU (graphics processing unit) computing resources to improve the license plate recognition performance	-	No	<ul style="list-style-type: none"> • Checkbox is set - the GPU computing resources are used to increase the performance of license plate recognition. • Checkbox is not set - the CPU (central processing unit) computing resources are used.

No	Parameter name	Parameter setting method	Description	Data type	Default value	Value range
2	Accuracy drop-down list	Selecting the value in the list	Selecting the numbers recognition accuracy	List	Maximum	<ol style="list-style-type: none"> 1. Maximum - enables maximum recognition accuracy, but it causes great CPU and/or GPU load. 2. High - enables high recognition accuracy, it requires less computing resources than for maximum accuracy. 3. Fast - enables high recognition speed, but the accuracy becomes worse.
3	Strategy drop-down list	Selecting the value in the list	Selecting the computing resources use mode	List	System	<ol style="list-style-type: none"> 1. Process - mild mode: no more than 1 core for 1 license plate. 2. System - default mode: all available computing cores are in use; 3. Core - strict mode: 1 core per stream.
4	Platform drop-down list	Selecting the value in the list	Selecting the device on which the module will operate	List	CPU	<ul style="list-style-type: none"> • Default — CPU resources are used for computing. • TensorRT — NVIDIA GPU resources are used for computing. • CV22, NCNN, HISI, Qualcomm, TFLite, OpenVino - other device resources are used for computing, if available. These options apply to platforms other than x86/x64.
5	Interval field	Enter the value in the text field	Specifying the minimum time interval lasting between the frames processing (i.e. all frames within this interval will not be processed)	ms	0	In range of 0 to 999

No	Parameter name	Parameter setting method	Description	Data type	Default value	Value range
6	Profile drop-down list	Selecting the value in the list	Selecting the profile of country license plates that are to be recognized. Greater profile number enables more accurate LPR comparing to the solution with smaller number, but it is more demanding to computing resources	List	0	<ul style="list-style-type: none"> 0 - Common. This profile should be selected if By default is selected for the issuing country. 3, 6 and 9 – for more information see The LPR IntelliVision module functionality section.

6.2 Appendix 2. Examples of widely used scripts

6.2.1 General information about scripts

User scripts are designed for partial automation of processes while the *Auto-Intellect* software package configuring. In the [Intellect Software Package Programming Guide](#) document there is description of programming objects and methods which are in use for scripts creation in the *Intellect* software.

Usually scripts are created for tasks of concrete video surveillance system.

6.2.2 Scripts used in the Auto-Intellect software package

The following scripts are widely used in the *Auto-Intellect* software package.

No	Purpose of script	Script
1	Start of Auto-Uragan program module	<pre>if(Event.SourceType == "MACRO" && Event.SourceId == "1" && Event.Action == "RUN"){ DoReactStr("ULPR", "1", "START", ""); } }</pre>
2	Shutdown of Auto-Uragan program module	<pre>if(Event.SourceType == "MACRO" && Event.SourceId == "1" && Event.Action == "RUN"){ DoReactStr("ULPR", "1", "STOP", ""); } }</pre>
3	Activation of window of operator request by results of recognized vehicle license plate found in the external database	<pre>if(Event.SourceType == "LPRDB" && Event.SourceId == "1" && Event.Action == "SEARCH_RESULT") { DoReactStr("ULPR", "1", "STOP", ""); var msg=Event.Clone(); var m=msg.GetParam("comment"); var d=msg.GetParam("date"); var number=msg.GetParam("column.0.value"); DoReactStr("DIALOG", "black_list", "RUN", "param0<"+number+">, column.4.value<"+m+">,date<"+d+">"); } }</pre>

4	Video conversion to AVI format with record of vehicle, license plate of which is recognized	<pre> function printDate(temp) { var dateStr = padStr(temp.getDate())+"-"+ padStr(temp.getMonth())+"-"+ padStr(temp.getFullYear())+" "+ padStr(temp.getHours())+": "+ padStr(temp.getMinutes())+": "+ padStr(temp.getSeconds()); return dateStr; } function padStr(i) { if(i > 1000) { var temp = ""+i; temp = temp.substr(2,2); return temp; } return (i < 10) ? "0" + i : "" + i; } if(Event.Action == "NUMBER_DETECTED" && Event.SourceType=="ULPR" && Event.SourceId=="1") { var plate = Event.GetParam("plate"); debugger; if(plate == "o270ca99") //if(Event.Action == "RUN" && Event.SourceType=="MACRO" && Event.SourceId=="1") { DoReactStr("CAM", "1", "REC_STOP", ""); DoReactStr("CAM", "1", "REC", "delay<500>"); var time = Event.GetParam("time"); var date = Event.GetParam("date"); var tArr = time.split(":"); var dArr = date.split("-"); var shift = new Date("20"+dArr[2],dArr[1],dArr[0],tArr[0],tArr[1], tArr[2]); shift.setSeconds(shift.getSeconds()+30); var time1 = printDate(shift); var filename = date+"_"+time+".avi"; filename = filename.replace(/:/g, "_"); filename = filename.replace(/-/g, "_"); var oShell = new ActiveXObject("Shell.Application"); var commandtoRun = "C:\\Program Files (x86)\\Intellect\\Tools\\ Converter.exe"; var arguments = "\\c:\\backup\\"+filename+"\\", \"1\", \" "+date+" "+time+"\\", \" "+time1+"\""; DebugLogString(arguments); </pre>
---	---	---

		<pre>oShell.ShellExecute(commandtoRun,arguments,"","open","1"); } }</pre>
5	Raising of turnpike	<pre>if(Event.SourceType == "LPRDB" && Event.SourceId == "1" && Event.Action == "SEARCH_RESULT") { DoReactStr("GRELE","1","ON",""); Sleep(5000); DoReactStr("GRELE","1","OFF",""); }</pre>
6	<p>Creation of a passing vehicle event. The information is displayed in the Online Monitor and recorded to the database:</p> <ol style="list-style-type: none"> 1. Request without parameters — an empty result containing an undefined LP number is returned; 2. Request with the plate parameter — the result containing the LP number is returned. If the LP number coordinates are not specified (plate_left, plate_top, plate_right, plate_bottom), then whole frame will be displayed; 3. Request with any database parameters that are displayed in the Online Monitor. For example, LP number coordinates (plate_left, plate_top, plate_right, plate_bottom), confidence, direction, hazard_class. 	<ol style="list-style-type: none"> 1. DoReactStr("ULPR","1","CREATE_EVENT",""); 2. DoReactStr("ULPR","1","CREATE_EVENT","plate<A777AA777>"); 3. DoReactStr("ULPR","1","CREATE_EVENT","plate<A777AA777>,plate_left<200>,plate_top<200>,plate_right<300>,plate_bottom<300>,confidence<15>,direction<2>,hazard_class<Very dangerous>");

6.3 Appendix 3. Database replication via MS SQL Server

Note. Detailed information about database replication via MS SQL Server is given in reference manual— for example, page <http://msdn.microsoft.com/en-gb/en-es/library/ms151847%28v=SQL.90%29.aspx>

Note. In case of some problems with database replication via MS SQL Server apply to Microsoft technical support service (see http://support.microsoft.com/?ln=ru_).

6.3.1 Introduction

Replication is the process of data coping among databases that are in the same or different servers and connected via LAN, WAN or Internet. The following terms are used in MS SQL Server replication:

Term	Description
Publication	Server(database)that sends data to another server(database)
Distribution	Server that controls data flow via replication system. Contains a specialized distributor database. Distribution and Publication can coincide.
Subscription	Server(database)that receives data from the other server(database)

Publication	Sum of articles, sent to Subscription
Article	Main replication module: table or table's subset
Subscription	Data group, received by Subscription
Distribution database	System database that is saved at Distribution and doesn't contain user tables. Is used for saving the task snapshots and all the transactions, waiting for distribution by the Subscription

Note.

On default Replication service is not installed together with MS SQL Server Express.

Note.

MS SQL Server Express cannot be used as Publication or Distribution.

In the *Auto-Intellect* distributed architecture it is reasonable to use replication with topology «Central subscription». In this case several Publication servers (for example servers, installed on traffic control posts) copy the data to the central server–Subscription.

As it is necessary to transmit data among servers of databases, it is recommended to use transactions replication. This replication type is also preferable in case when copied data constantly change, size of copied data is sufficiently great and not necessary to support auto changes of replicated data regarding Publication and Subscription servers. All described terms are executed in the *Auto-Intellect* distributed architecture.

The following agents are used while replicating:

1. Shots agent. Creates files of databases shots, saves shots in the Distribution server and saves information about shots synchronization state to the Distribution server's database.
2. Register reading agent. Compiles transactions, selected for replication, from the transactions register (that is on the Publication server) to Distribution server's database.
3. Distribution agent. Compiles processing task shots from Distribution server's database to Subscription servers; compiles all the transactions, waiting for distribution, to Subscription servers.

6.3.2 Replication setup

Replication setup is made in the following sequence:

1. Setup the Publication server, having created a new publication.
2. Setup the Subscription server, having created a subscription to publish the Publication server.

6.3.2.1 Replication setup features

While setting up the publication, the following features should be born in mind:

1. Run the MSSQLServer and SQLServerAgent server with Windows domain's account, as the LocalSystem account is not provided with access to net resources.
2. Replication setup and configuration may be performed only by sysadmin users on MS SQL Server.
3. Service SQLServerAgent and MSSQLServer should be run to replicate the data.
4. Necessary footprint should be entered for Distributor server's database.
5. To replicate tables, containing external keys, all the linked tables should be included into publication.
6. Publication server should be determined on the Subscriber server as a remote server..

6.3.2.2 Publication setup

To set up Publication server follow the steps:

1. Connect to Publication server in the Microsoft SQL Server Management Studio, and then open the server node.

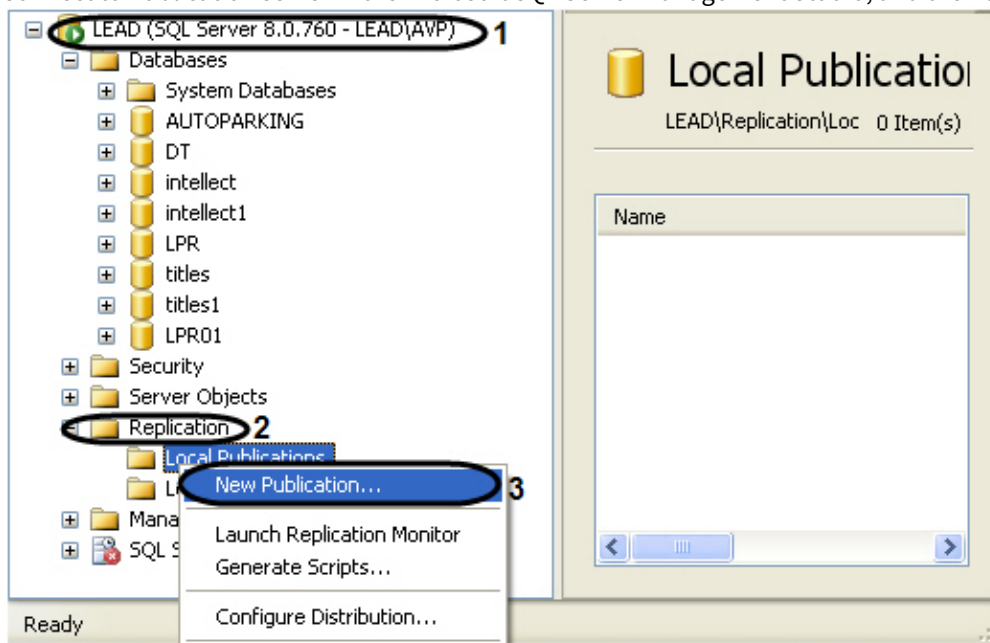

2. Open **Replication** folder and then click with a right mouse button over the **Local Publications** folder (2).
3. Select the point **New Publication** in the opened contextual window (3).
4. **New Publication Wizard** will be displayed in result.
5. Following the instructions of **New Publication Wizard**, enter the following information about publication:
 - a. Distribution server;
 - b. Directory, where databases' instant shots will be located;
 - c. Database that has to be replicated;

Note.

LPREX database should be selected while setting up the replication of plates recognition databases.

- d. Type of created publication (it is recommended to select transactions' publication or transactions' publication with update subscriptions);
- e. Data and data base objects (articles) to be included into publication;
- f. steady-state filters of lines and columns;
- g. Shots agent schedule;
- h. Accounts that have to run active replication agents (see section [Administrator's Guide. Introduction](#));
- i. Name and publication description.

Publication server is completed.

6.3.2.3 Subscription setup

To set up Subscription server follow the steps:

1. Connect to Publication server in the Microsoft SQL Server Management Studio, and then open the server node (1).

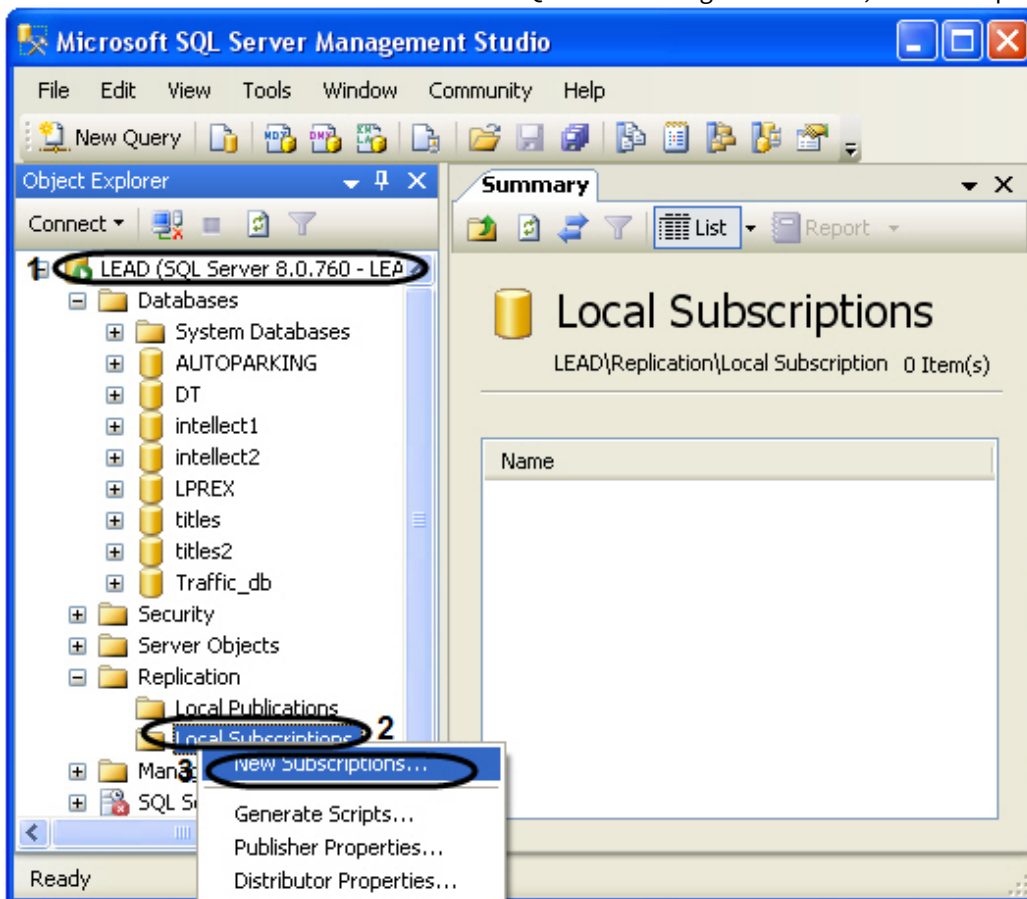

2. Open **Replication** folder, and then click with a right mouse button over the **Local Subscriptions** folder (2).
3. Select the **New Subscriptions** point in the opened contextual window (3).
4. **New Subscription Wizard** will be displayed in result.
5. Following the instructions of **New Subscription Wizard** enter the following information about subscription:
 - a. Publication name, that is being subscribed;
 - b. Publication server name and subscription database name;
 - c. Whether the Distribution server's agent runs on distribution or subscription;
 - d. Whether the Distribution server's agent operates constantly, according to schedule or on demand;
 - e. If there is necessity for the agent to create shots of original short for subscription and also necessity for distribution agent to use this shot on the subscription server;
 - f. Accounts which the Distribution agent will be run with.

Subscription setup is completed.

6.3.3 Example of setting up the Traffic replication database

Two kinds of servers take part in the replication:

1. Server, publishing the data, i.e. where the data are added and transferred to the central database;
2. Server, storing data from all the publishing servers to a single central database.

Publishing servers should operate under control of the «SQL Server 2008»full version.

Note.
SQL Server Express program doesn't permit data publishing.

Note.

Setting up the replication for recognition database is done in a similar way.

6.3.3.1 Setting up the replication on the publishing server

To set up the replication do the following operations on every server, publishing the data:

1. Run the utility **Sql Server Configuration Manager** (for this select on the taskbar: **Start -> Programs->Microsoft SQL Server 2008-> Configuration Tools-> SQL Server Configuration Manager**).
2. The utility window **Sql Server Configuration Manager** will open in result.
3. On the left part of the **Sql Server Configuration Manager** utility select the value **SQL Server Services (1)**.
4. SQL Server service will be displayed on the right part of the window in result. It is necessary to check whether the **Sql Server Agent (MSSQLSERVER)** service is run:
 - a. In case when the **Sql Server Agent (MSSQLSERVER)** is run there will be **Running** value in the column **State (2)**.
 - b. In case when the **Sql Server Agent (MSSQLSERVER)** is not run, run it by clicking the **Play** button on the upper control panel (3).

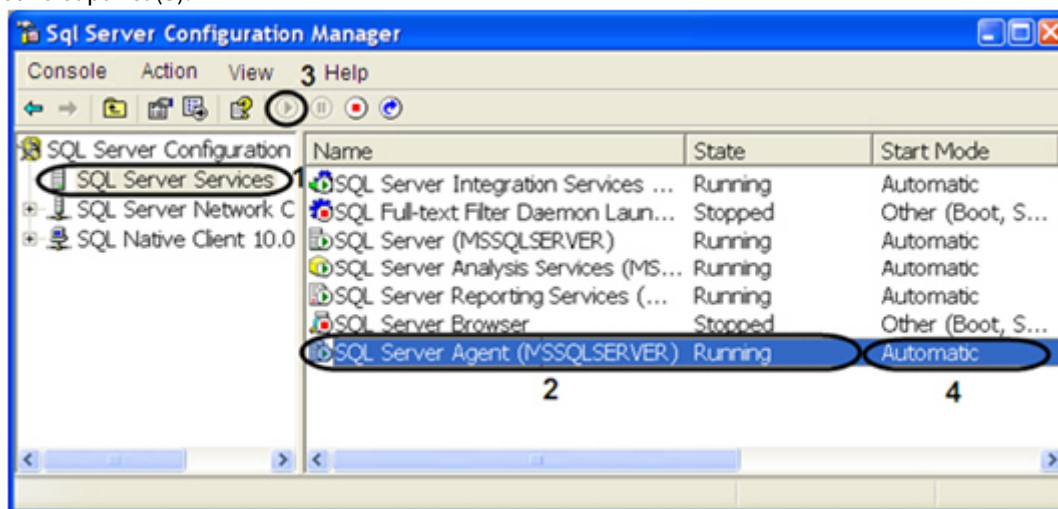

5. **Sql Server Agent (MSSQLSERVER)** service can be configured for auto run of the server or may be run manually. To set the auto run parameters do the following:
 - a. Give a right click upon the **Sql Server Agent (MSSQLSERVER)** service.
 - b. Select the **Features** point in the opened contextual window.
 - c. **Features: Sql Server Agent (MSSQLSERVER)** window will open in result.
 - d. Go to the **Service** tab (1).
 - e. From the dropdown list of the **Start Mode** parameter select the **Automatic** value (2).

f. Click **Ok** to save the changes (3).

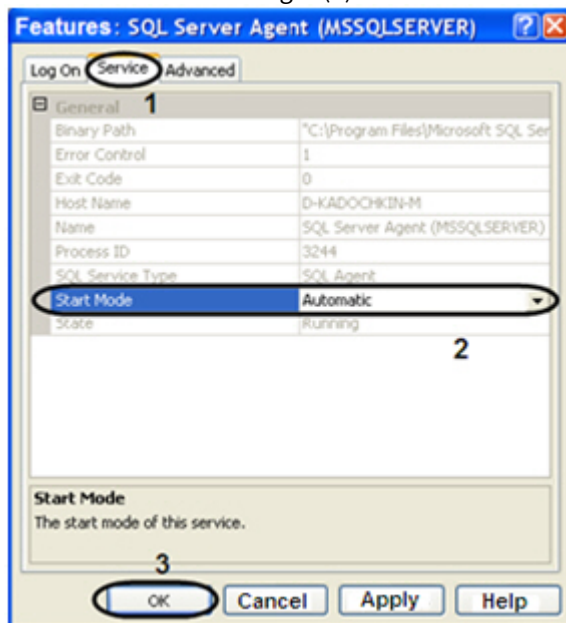

g. The **Start Mode** parameter was named as **Automatic** in result (4).

6. Run the **Microsoft Sql Server Management Studio** utility and after connecting to the data publishing server open the server node (1).

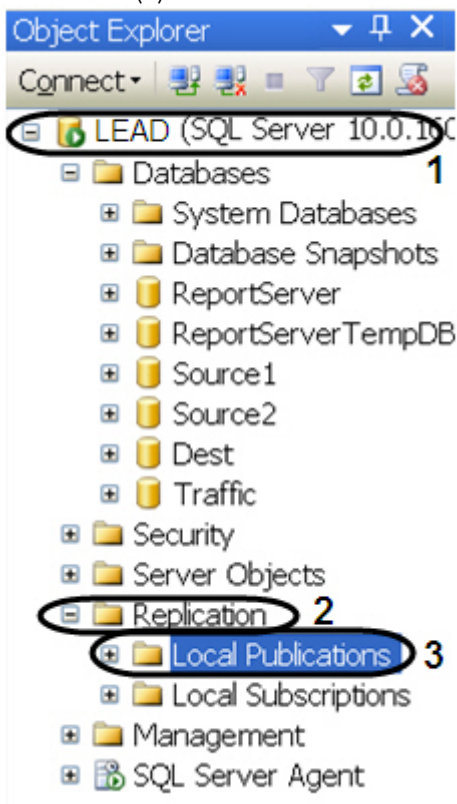

7. Open the **Replication** folder (2), and then make a right click upon the **Local Publication** folder (3).

8. Select the **New Publication** point in the opened contextual menu.

9. **New Publication Wizard** will be displayed in result.

10. Following the wizard's instructions **New Publication Wizard**, enter the following information about the publication:

a. Select the distributor database from the **Databases** list (1).

- b. Click **Next** to continue (2).

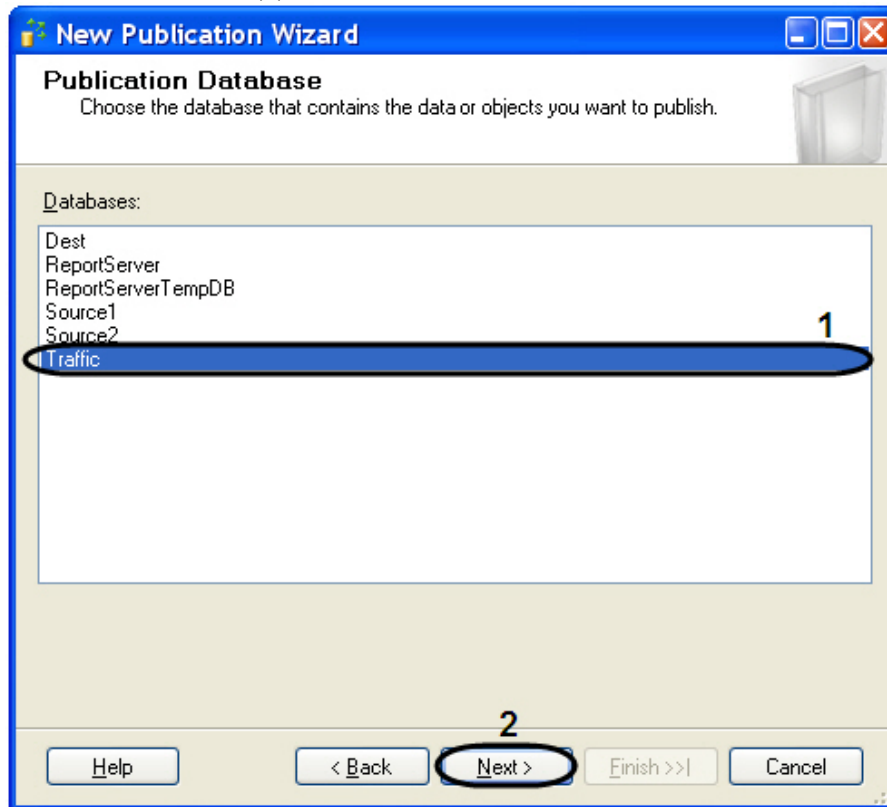

- c. Select the type value of the publication that is being created from the **Publication Type - Merge publication** list (1).
 d. Click **Next** to continue (2).

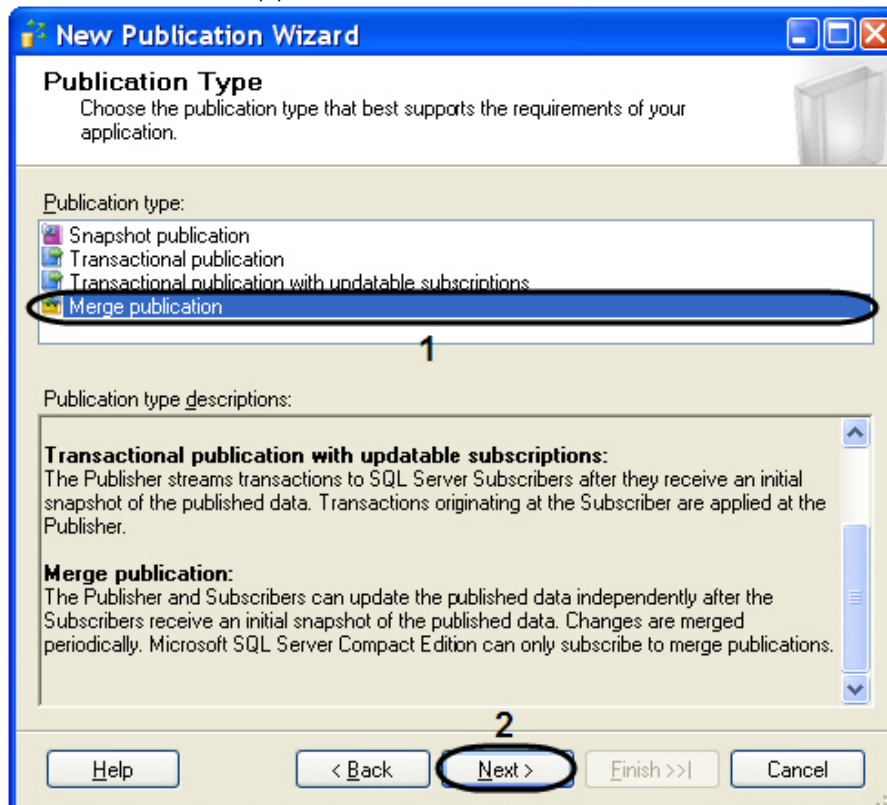

- e. State the subscriber type, setting the **Sql Server 2008** checkbox (1).

f. Click **Next** to continue (2).

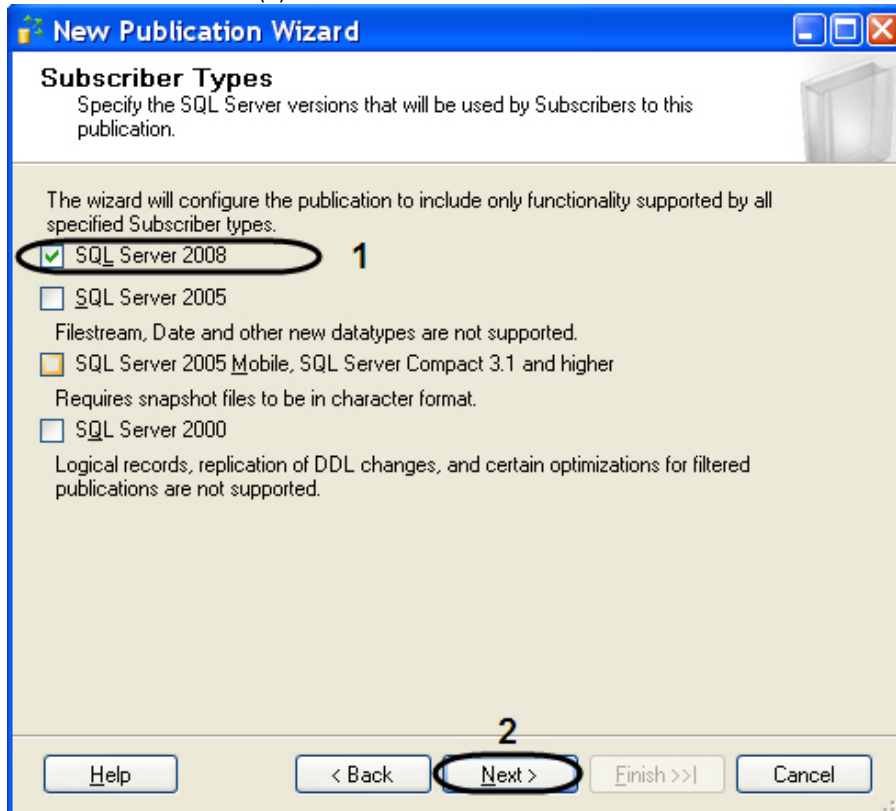

- g. State the database objects to be included into publication, setting the **Tables** checkbox (1).
- h. Click **Next** to continue (2).

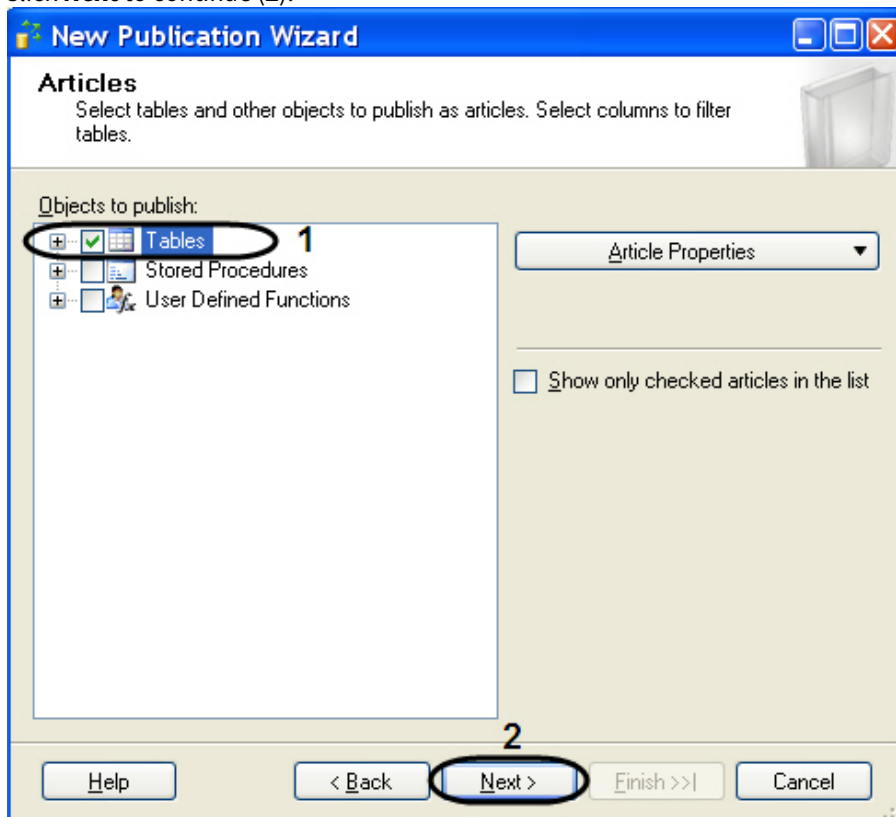

i. Do not change next two tabs.

- j. Go to the Snapshot Agent tab **Agent Security** and click the **Security settings** button (1).

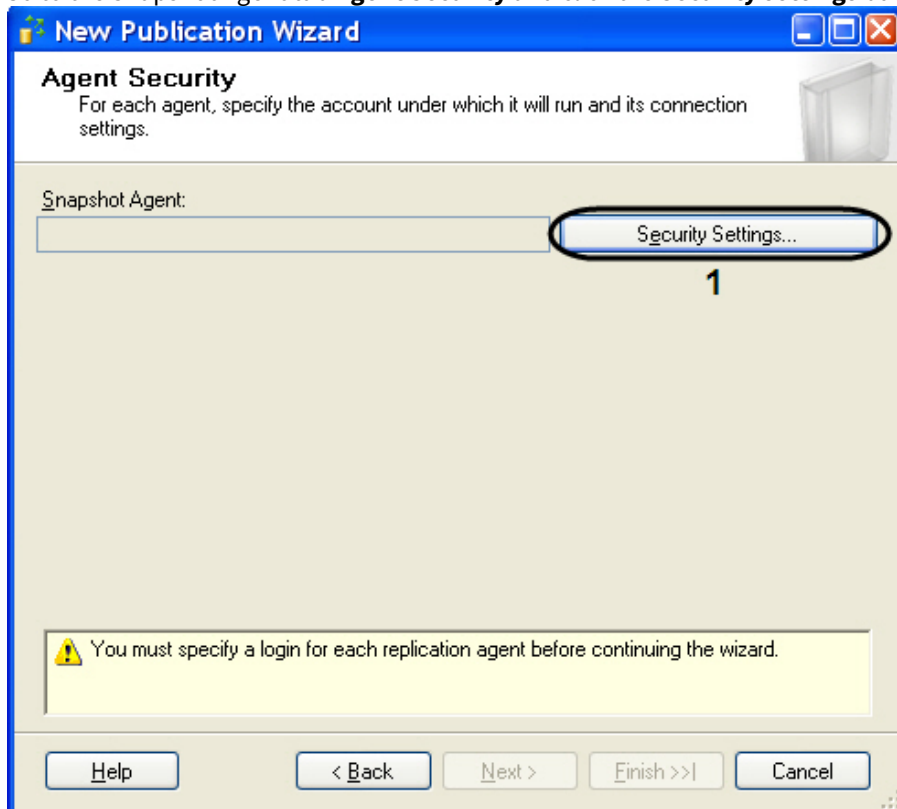

- k. **Snapshot Agent Security** window will open in result.
 l. Set the switch to the position **Run under sql server Agent service account (This is not a recommended security best practice)** (1).
 m. Click **OK** for saving the changes (2).

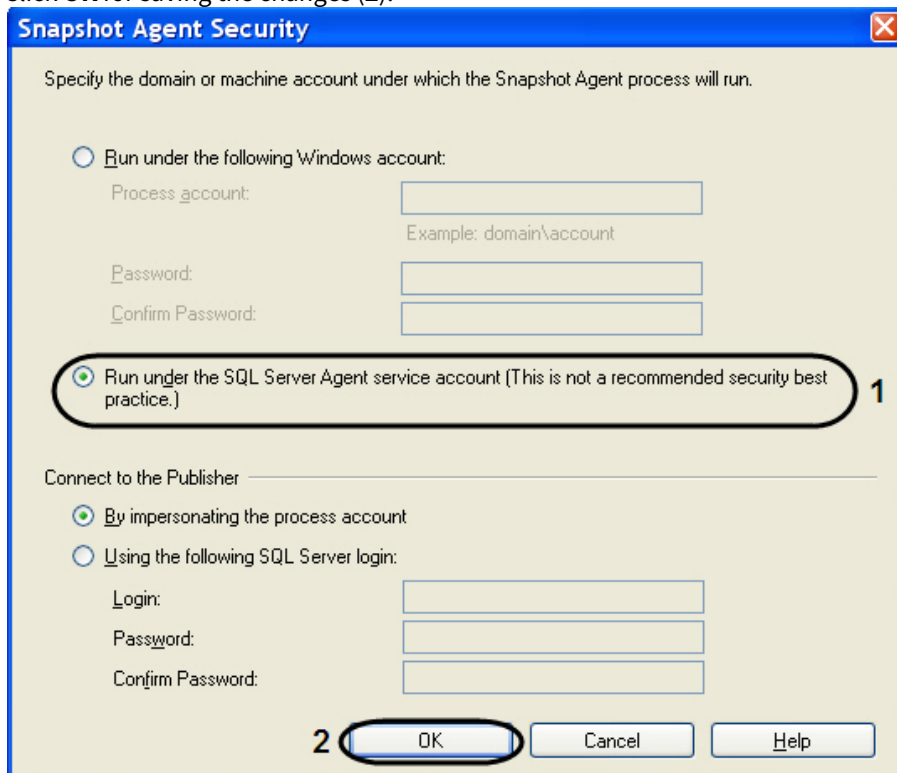

- n. On the **Complete the wizard** tab enter the publication name in the field **Publication name** (1).

- o. Click **Finish** to create a new publication (2).

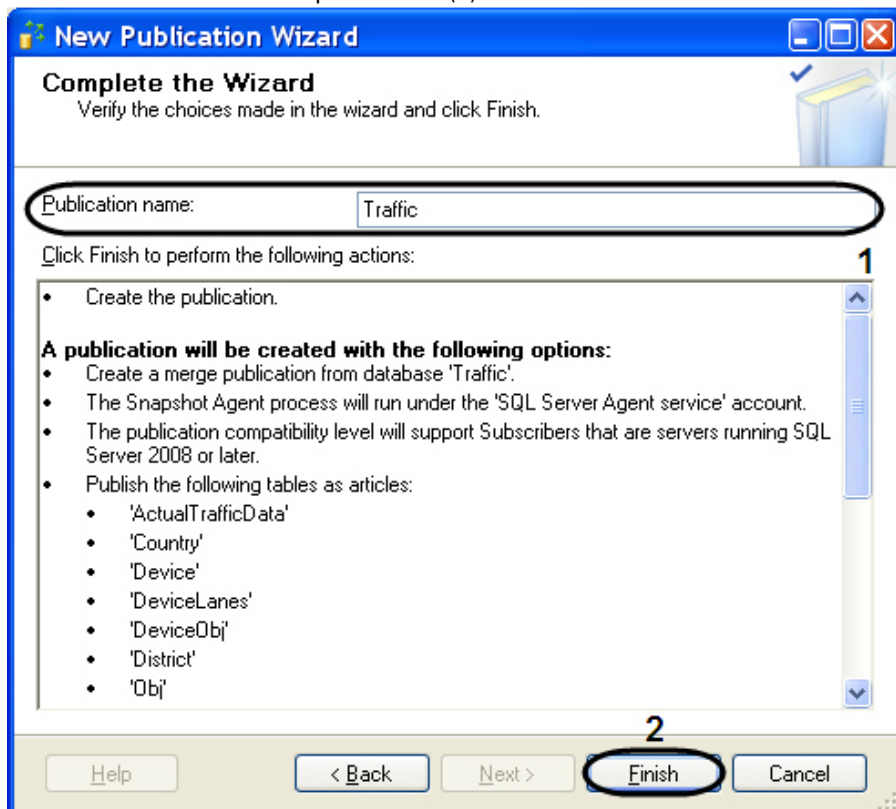

- p. In the **Creating Publication** opened window there will be displayed the process of tasks performance while creating a new publication.
- q. Click **Close** to finish the **New Publication Wizard** operation.

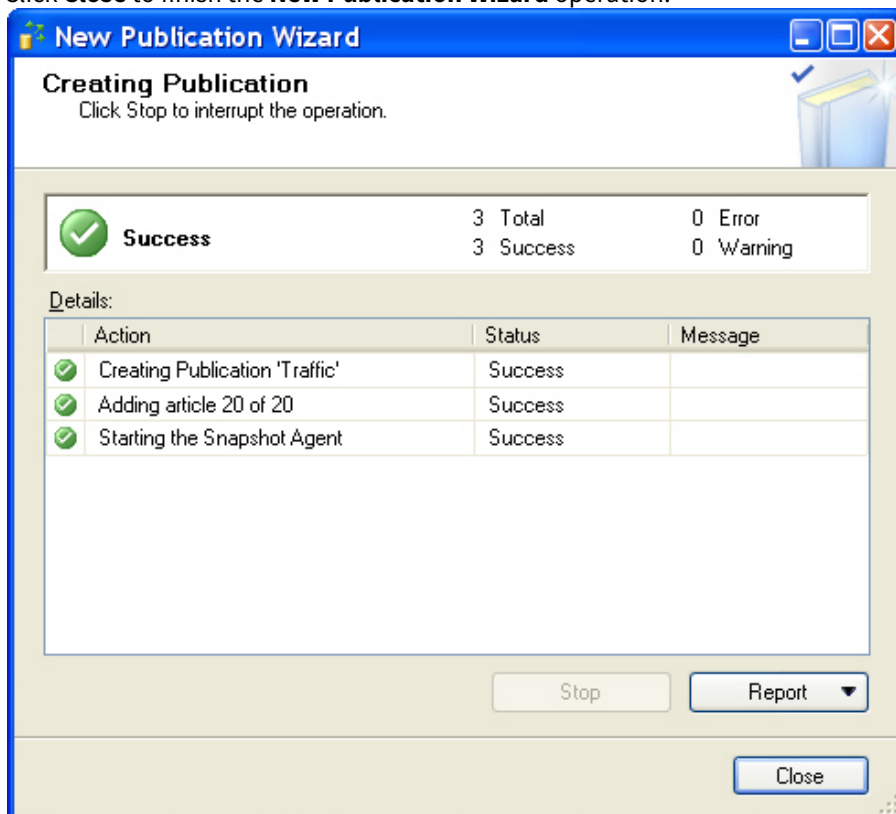

Setting up the replication on the publishing server is completed.

6.3.3.2 Setting up replication on the subscriber server

To set up replication do the following on the subscription server, gathering data from all the publishing servers:

1. Run **Sql Server Configuration Manager** (For this select on the taskbar: **Start -> Programs -> Microsoft SQL Server 2008 -> Configuration Tools -> SQL Server Configuration Manager**).
2. Make sure, that **SQL Server Agent** service is run and configured fro auto start (see section [Setting up the replication on the publishing server](#), points 3-5).
3. Run the **Microsoft Sql Server Management Studio** utility and after connection to the subscription server open the server's node (1).
4. Open the **Replication** folder (2) and then make a right click upon the **Local Subscriptions** folder (3).
5. Select the **New Subscriptions** point in the opened contextual menu.

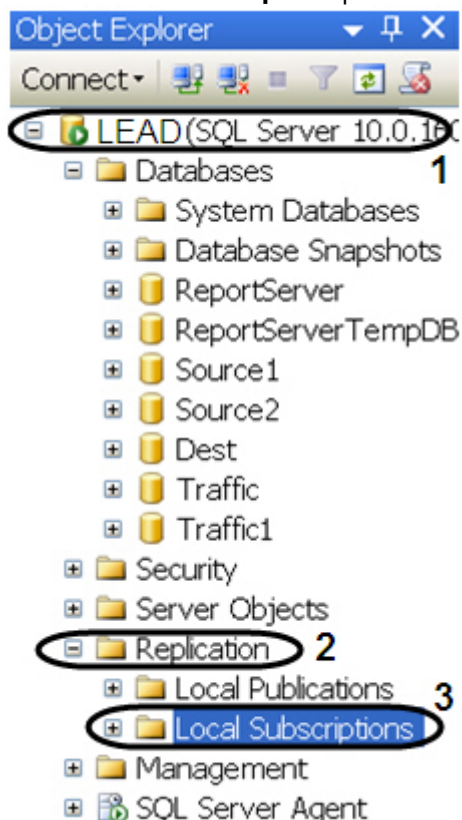

6. **New Subscription Wizard** will be displayed in result.
7. Select the publication server from the **Publisher** dropdown list (1).

Note.

If the publication server is absent in the list one should find it with the help of **Find SQL Server Publisher** function.

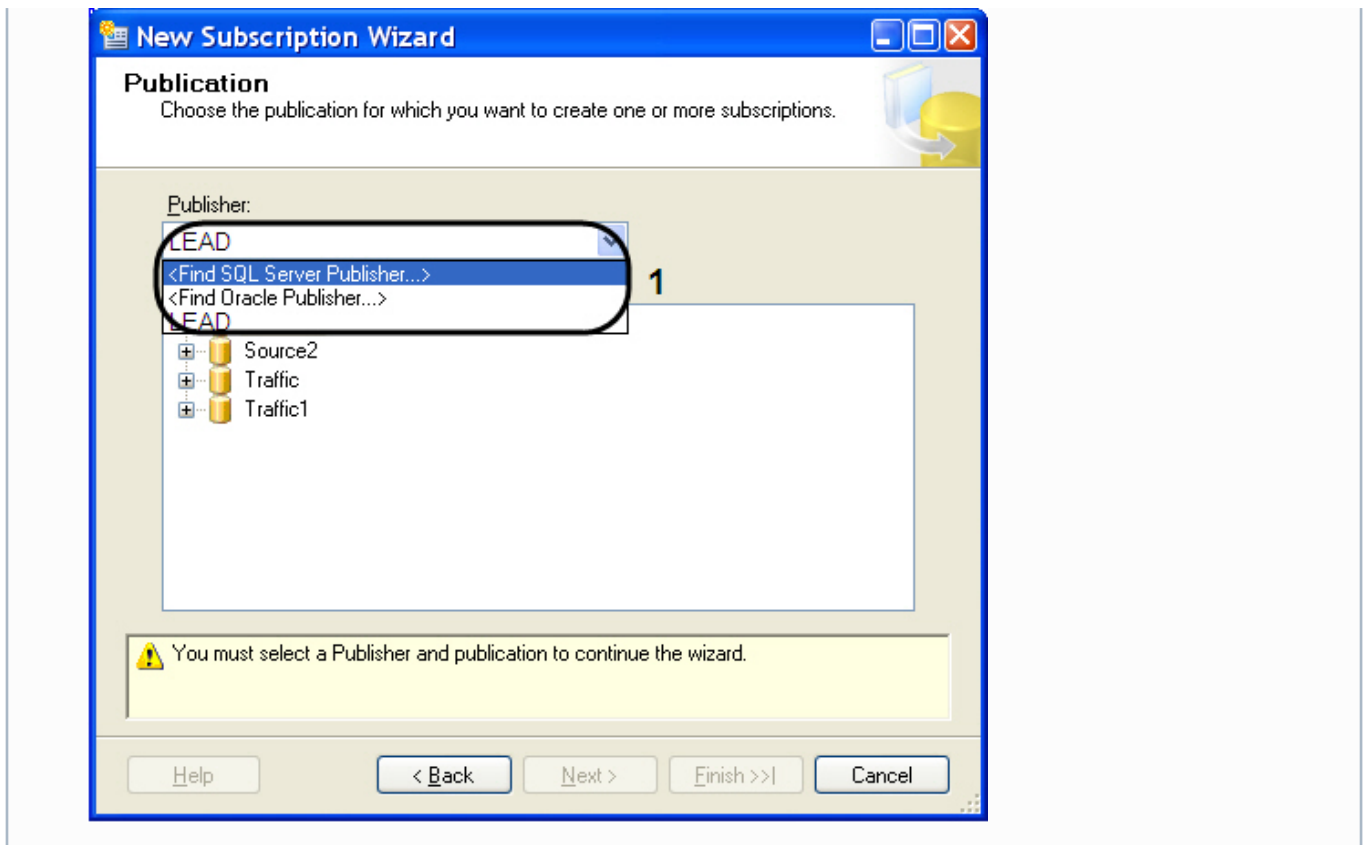

8. In the objects tree **Databases and publication** select the publication (1).



9. Click **Next** to continue (2).
 10. Leave the parameter **Merge Agent Location** unchanged.

11. In the **Subscribers** window set the checkbox **Subscriber** next to subscriber (1).

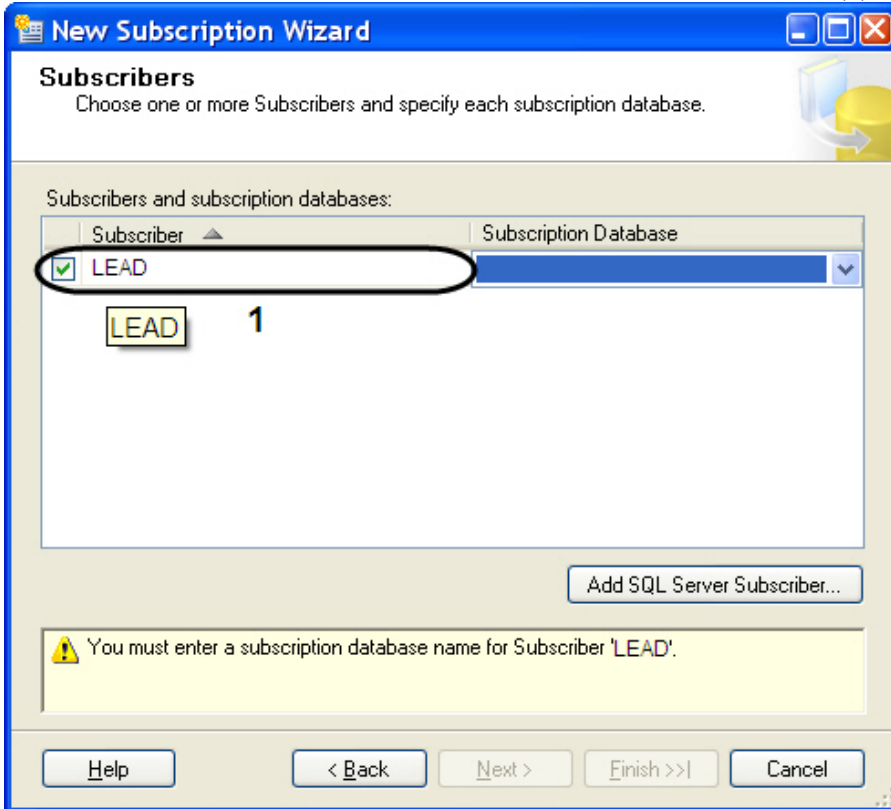

12. Select the subscription database from the **Subscription Database** dropdown list (1).



Note.

In case of connecting the first publishing server one should create a new subscription database, clicking the function **<New database...>**.

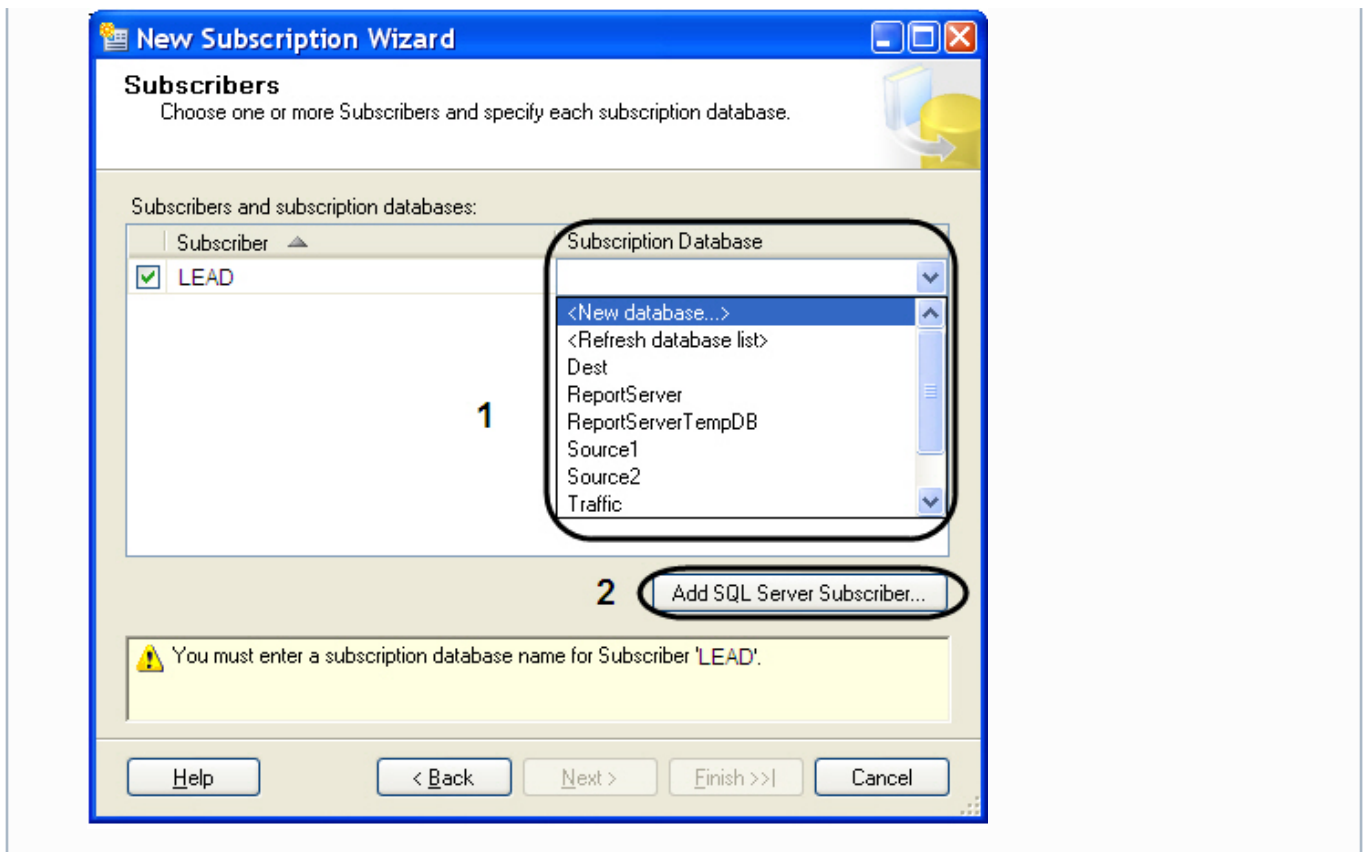

13. To add SQL Server subscriber click the button **Add SQL Server Subscriber...** (2).
14. **Merge Agent Security** window will open.
 - a. Set the switch to the **Run under SQL Server Agent service account (This is not recommended security best practice)** position (1).

- b. Click **Ok** to save the changes (2).

Merge Agent Security

Specify the domain or machine account under which the Merge Agent process will run when synchronizing this subscription.

Run under the following Windows account:

Process account:

Example: domain\account

Password:

Confirm Password:

Run under the SQL Server Agent service account (This is not a recommended security best practice.) **1**

Connect to the Publisher and Distributor

By impersonating the process account

Using a SQL Server login

The connection to the server on which the agent runs must impersonate the process account. The process account must be a member of the Publication Access List.

Connect to the Subscriber

By impersonating the process account

Using the following SQL Server login:

Login:

Password:

Confirm password:

The login used to connect to the Subscriber must be a database owner of the subscription database.

2

15. Click **Next** to continue.

16. For distributor agent constant operation select the value **Run continuously** from the **Agent Schedule** dropdown list in the **Synchronization Schedule** window (1).

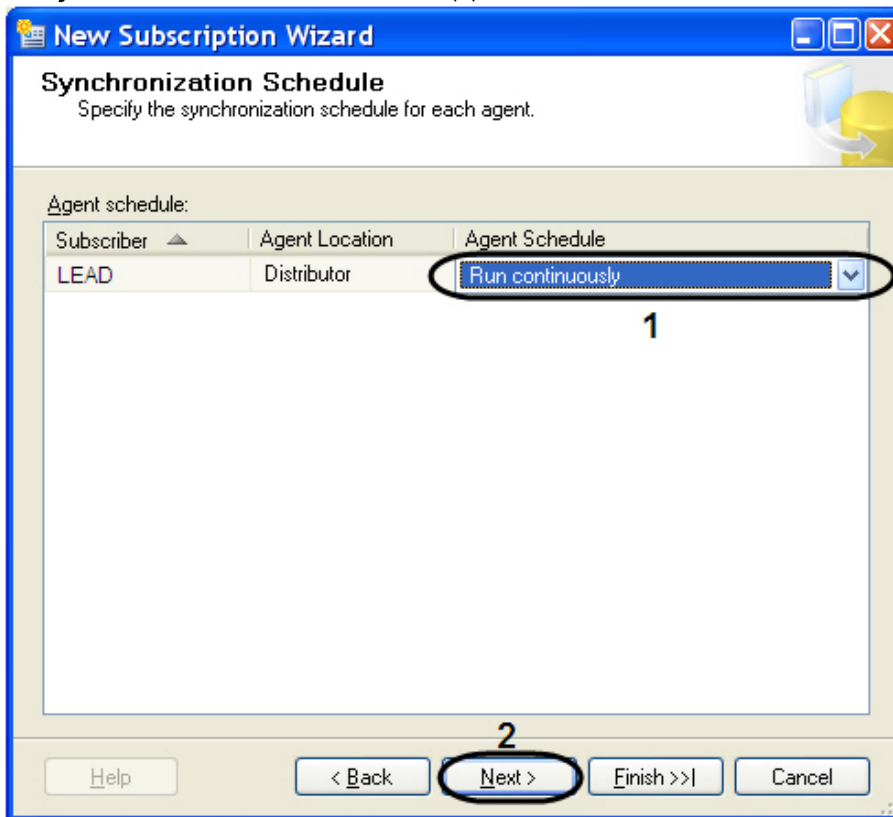

17. Click **Next** to continue (2).
18. In the **Initialize Subscription** window the following should be done:
- Set the **Initialize** checkbox in case of adding the first publishing server (1).
 - Uncheck the **Initialize** checkbox in case of adding the second and further servers (1).

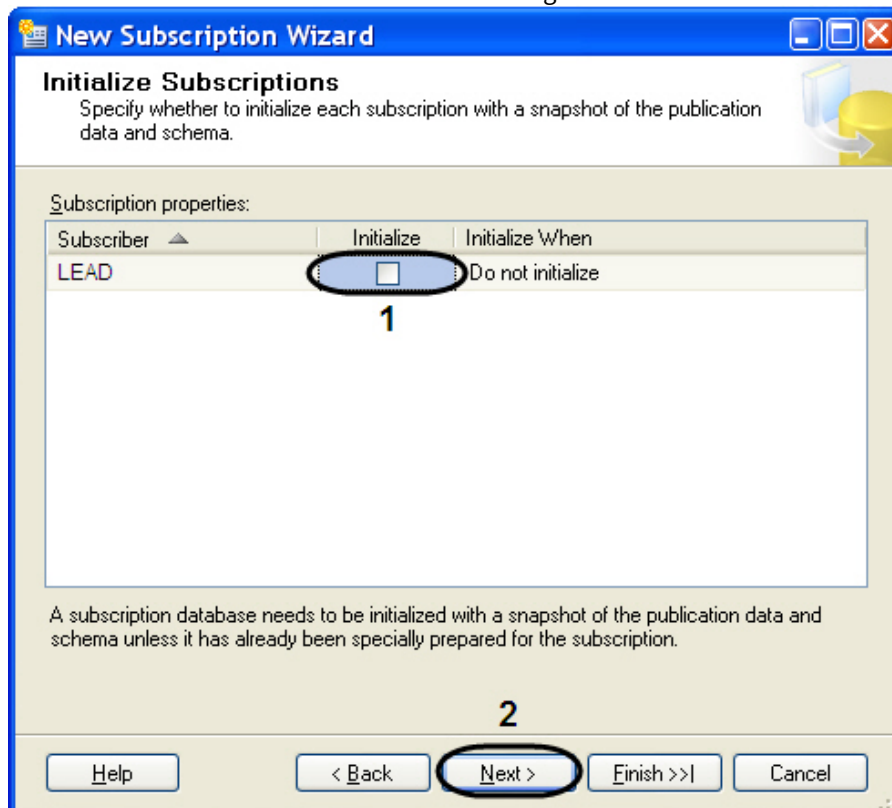

19. Click **Next** to continue (2).
20. Select the **Client** subscription type from the dropdown list **Subscription Type** in the **Subscription Type** window (1).

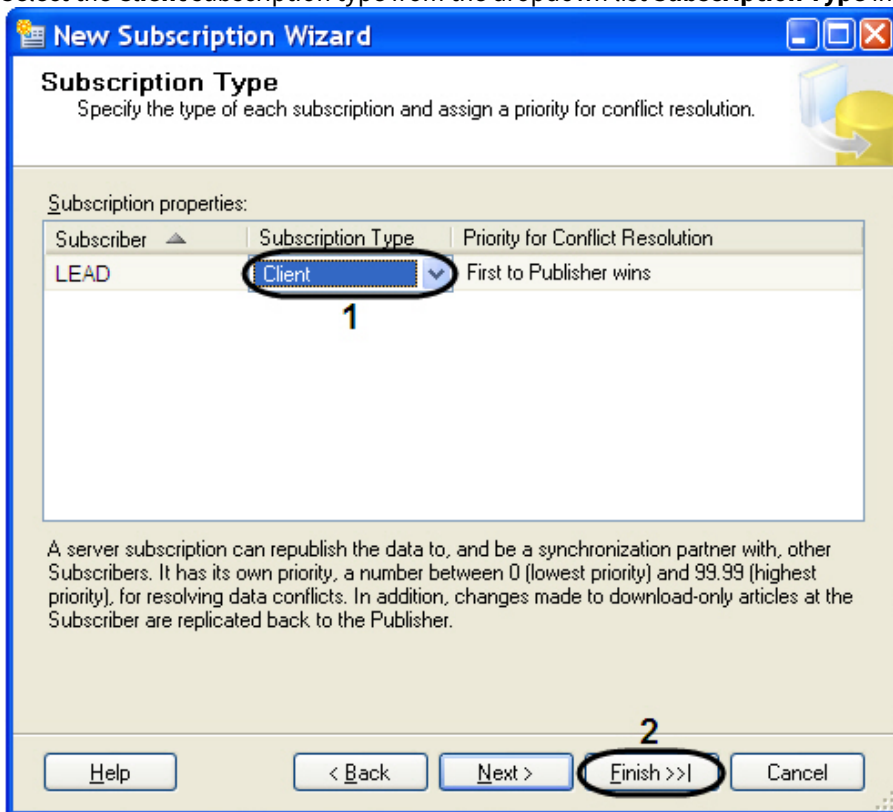

21. To end the creation of a new subscriber click **Finish** (2).
22. In the **Creating Publication** opened window there will be displayed the process of creating a new subscriber.
23. Click **Close** to end the process of **New Subscription Wizard** operation.

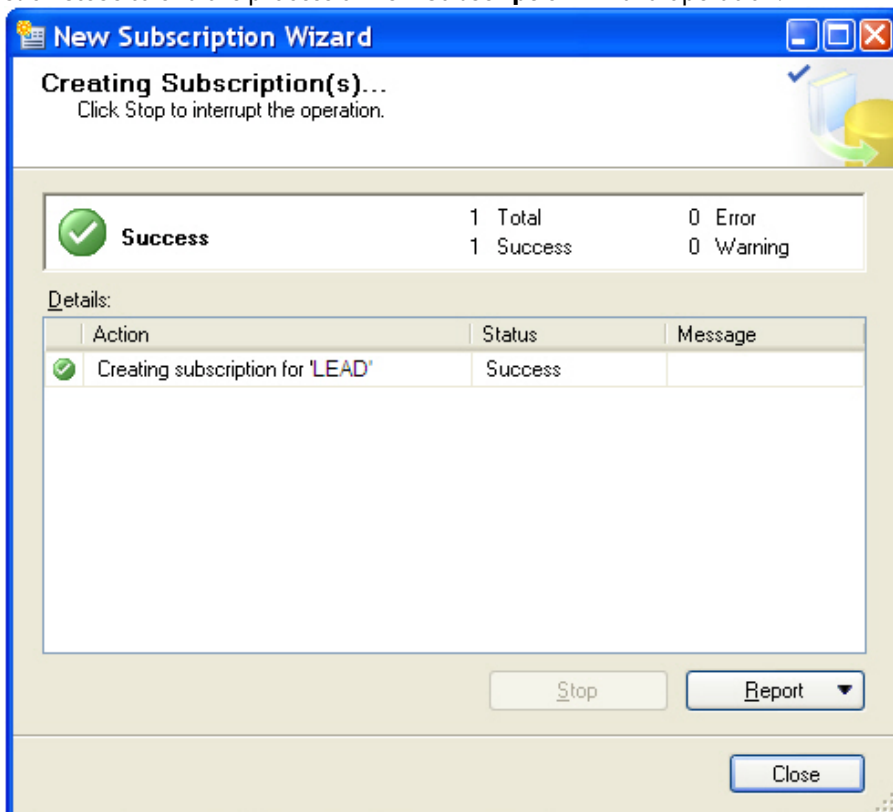

Setting up the replication on subscriber's server, gathering data from all the publishing servers is completed.

6.4 Appendix 4. Procedures for the Auto-Intellect database and software for fine imposing interaction

The software for fine imposing is designed for analyzing the stored Traffic enforcement, for checking and correcting the identified plates, imposing the fines.

For the *Auto -Intellect* database and this software interaction follow the procedures:

1. The procedure, returning the alarm list of the stated type for a stated period of time for the selected detector or for all the detectors (if NULL).

spGetDetectionEvents

@eventtype int, // alarm's type

@begindate DATETIME, // time«from»

@enddate DATETIME, // time «up to»

@detector uniqueidentifier = NULL //detector's ID

@speed_over INT=NULL, // speed exceeding (only for "Speed exceeding" alarms type). Ignored if it is not specified.

@secondFrameExistINT=1, // display events (only for "Red light running" alarms type), which have additional frame.

Check for additional frame is not performed if 0 or NULL

The following alarm types are singled out:

1 – Overspeeding;

2 – Found in the external database;

3 – Alarm, triggered by the operator;

4 – Running a red light;

5 – Entered the oncoming lane;

6 - Crossing a stop line;

7 - Stop a crosswalk;

8 - Running a red light traffic.

Fields described in the table will be returned in result of the *spGetDetectionEvents* procedure performing.

Name	Type	Description
event_time	datetime	Time of alarm
event_time_id	int	Type of alarm
valid_speed	Int	Permitted speed
speed	Int	Speed
speed_over	int	Overspeeding
car_number	nvarchar(50)	Licence plate
address	nvarchar(max)	Address, where the detector is located
direction	bit	Direction
processing_time	datetime	Time of alarm's processing by the operator
comments	ntext	Comments
db_name	nvarchar(50)	External database name
db_info	ntext	Information from the external database (XML format)
operator	uniqueidentifier	Operator's ID
frame	image	Frame
event_id	uniqueidentifier	Unique alarm identifier (GUID)

Name	Type	Description
red_light_on_time	datetime	Time of red light switching on
red_light_on_period	int	Time from begin of red phase to fixing violation on the image. Time is specified in seconds.

2. Procedure, returning the list of speed alarms for a stated period for the selected detector or for all the detectors (if NULL).

spGetSpeedEvents

@begindate DATETIME, // time «from»

@enddate DATETIME, // time «up to»

@detector uniqueidentifier = NULL // detector's ID

@speed_overINT=NULL // speed exceeding. Ignored if it is not specified.

Fields described in the table will be returned in result of the *spGetSpeedEvents* procedure performing.

3. Procedure, returning synchronous frames connected with event ID or all frames if parameter @event_id=NULL.

spGetFramesSecondary

@max_items int, // maximal number of output frames

@event_id uniqueidentifier // event ID. Event ID can be got using the *spGetDetectionEvents* or *spGetSpeedEvents* procedures.

Fields described in the table will be returned in result of the *spGetSpeedEvents* procedure performing.

Name	Type	Description
Id	uniqueidentifier	Secondary frame ID
Frames_id	uniqueidentifier	Primary frame ID
frame	image	Secondary frame
time	datetime	Time of the secondary frame recording on UTC scale

4. Procedure returning all registered license plates for the specified period. Data will be displayed page-by-page with specifying the page number (@pagenumber) and page size (@pagesize).

spGetRegisteredPlates

@begindate datetime, // time "from" (on UTC scale)

@enddate datetime, // time "up to" (on UTC scale)

@pagenumber int, // page number to output

@pagesize int, // page size to output

@totalrows int OUTPUT, // total number of strings complying with query

Fields described in the table will be returned in result of the *spGetRegisteredPlates* procedure performing.

Name	Type	Description
plate	nvarchar(50)	Vehicle license plate
region	int	Region of license plate
validity	int	Quality of recognized LP, 0-100%
time	datetime	Time of license plate recording on UTC scale

5. Procedure returning all registered license plates for the specified period. Data will be displayed page-by-page with specifying the page number (@pagenumber) and page size (@pagesize).

spGetRegisteredPlatesFull

@begindate datetime, // time "from" (on UTC scale)

@enddate datetime, // time "until" (on UTC scale)

@pagenumber int, // page number to output

@pagesize int, // page size to output

@totalrows int OUTPUT, // total number of strings complying with query

@cameralds nvarchar(max) NULL, // list of cameras ID separated by | symbol in the *Intellect* software.

Fields described in the table will be returned in result of the *spGetRegisteredPlatesFull* procedure performing.

Name	Type	Description
plate	nvarchar(50)	Vehicle license plate
region	int	Region of license plate
validity	int	Quality of recognized LP, 0-100%
plate_left	int	LP coordinates
plate_top	int	LP coordinates
plate_right	int	LP coordinates
plate_bottom	int	LP coordinates
preview_frame	image	Frame for preview
frame	image	Frame
plate_image	image	Image of cut license plate
detector_external_id	nvarchar(max)	Recognizer ID in the <i>Intellect</i> tree
detector_name	nvarchar(50)	Name of recognizer
detector_address	nvarchar(max)	Address of recognizer
camera_external_id	nvarchar(max)	Camera ID in the <i>Intellect</i> tree
camera_name	nvarchar(50)	Name of camera
time	datetime	Time of license plate recording on UTC scale

6.5 Appendix 5. Setting up the External plates database in «dbf» format.

To set up the External plates database in "dbf" format do the following:

1. Call for a dialog window **Program launch** or go to the **Start** menu and select **Run** or use the key combination **WIN+R**.

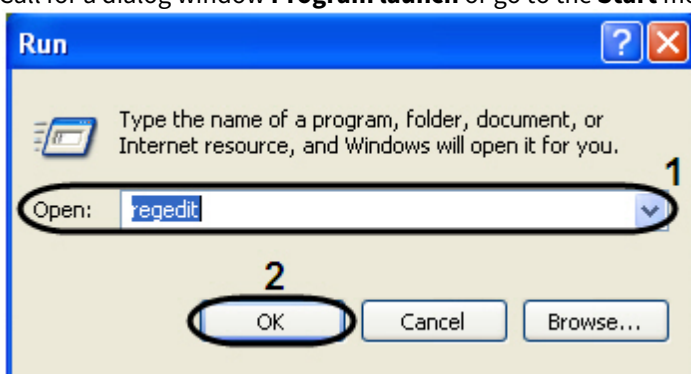

2. Enter **regedit** in the appeared window.
3. Click **OK**.

4. **Registry Editor** will open in result.

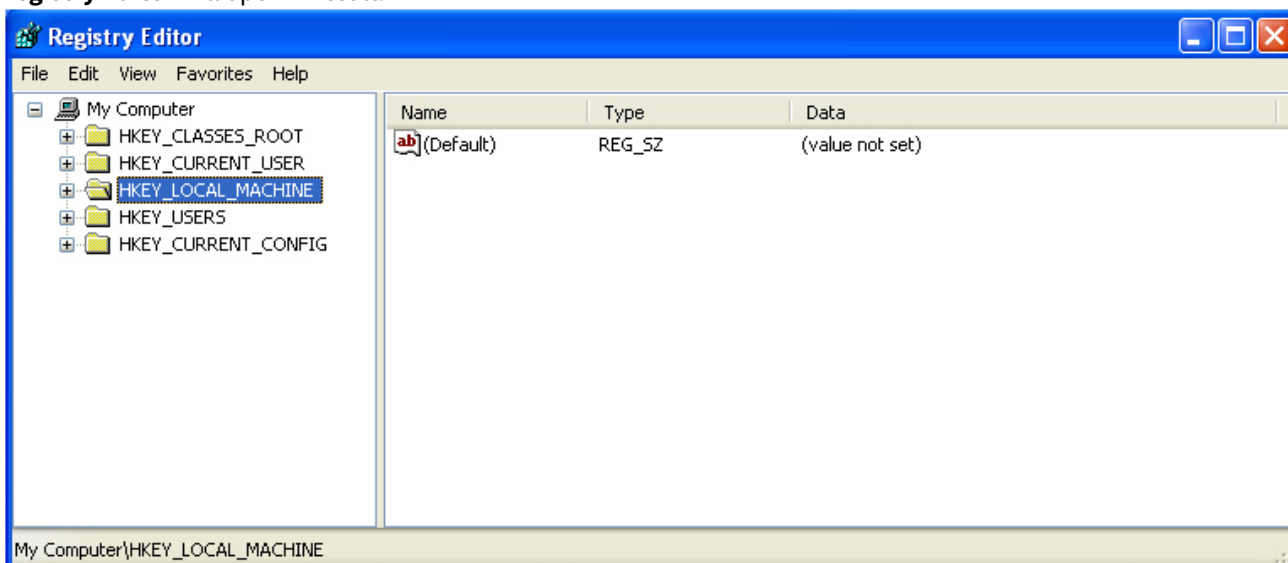

Note.

Detailed information about Registry Editor is given in the section Operation with OS Windows system register of the document [Intellect software package: Administrator's Guide](#).

5. In the register tree select **HKEY_LOCAL_MACHINE\Software\Microsoft\Jet\4.0\Engines\Xbase**.

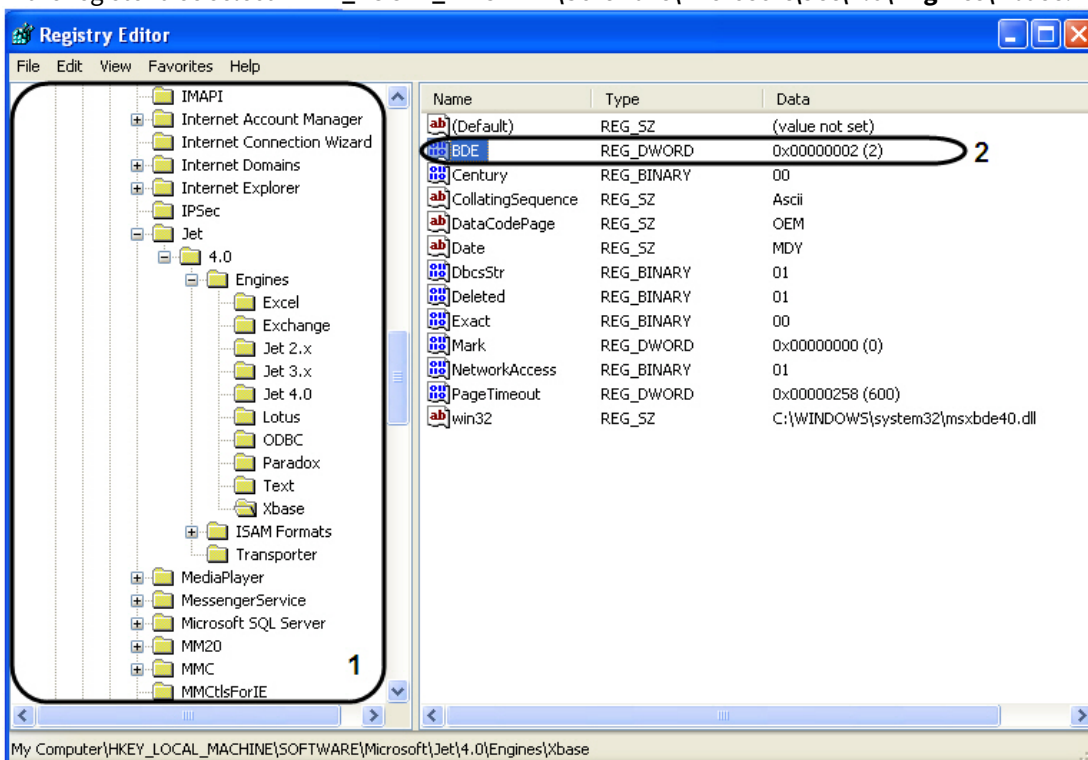

6. Select the menu point **Edit -> Create -> DWORD parameter**.
7. Assign a name to a new DWORD parameter. For this enter the name in the **BDE** in the activated field, where on default the name **New parameter №1** has already been entered, and then click a mouse in anywhere in the Registry Editor dialog window. The entered name of the new DWORD parameter will be automatically saved.
8. Set the value to the new string parameter. Make a double click with a left mouse key upon the parameter's name for this. **Edit DWORD value** will open in result.

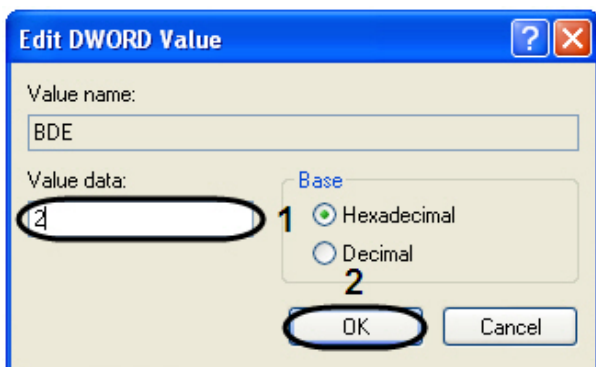

- a. Assign 2 value to the **BDE** parameter (1).
 - b. Click **OK** to save the changes (2).
9. DWORD **BDE** parameter will be created in result of operations in the registry (2).
10. To set up the connection to the external database do the following operation in the **Data Link properties** window:
- a. Go to the **Provider** tab.

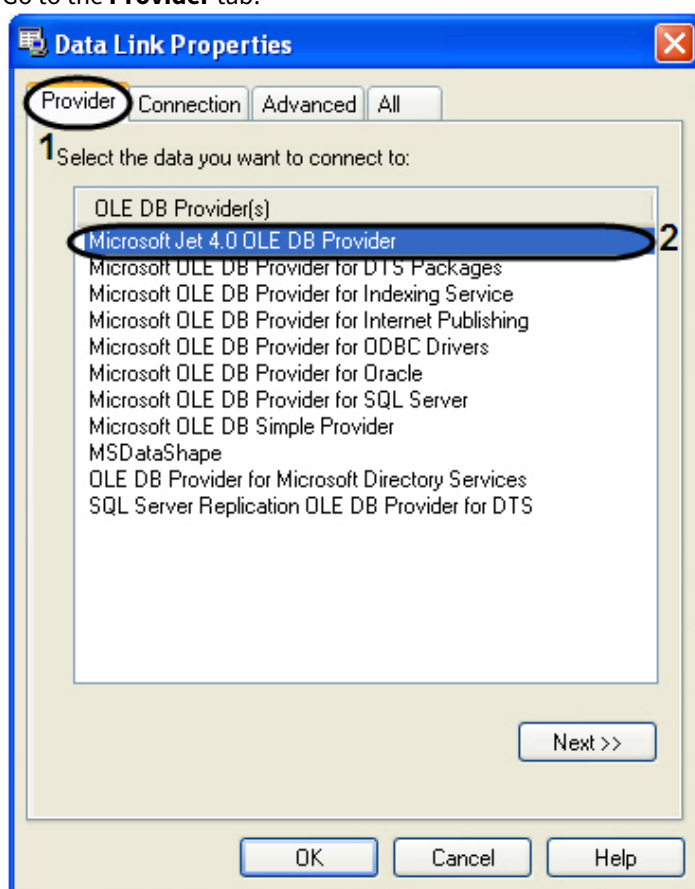

- b. From the **Providers OLE DB** list select the **Microsoft Jet 4.0 OLE DB Provider** point.
- c. Then go to the **All** tab (1).

- d. Set the path to **.dbf** files in the **Data Source** value range (2).

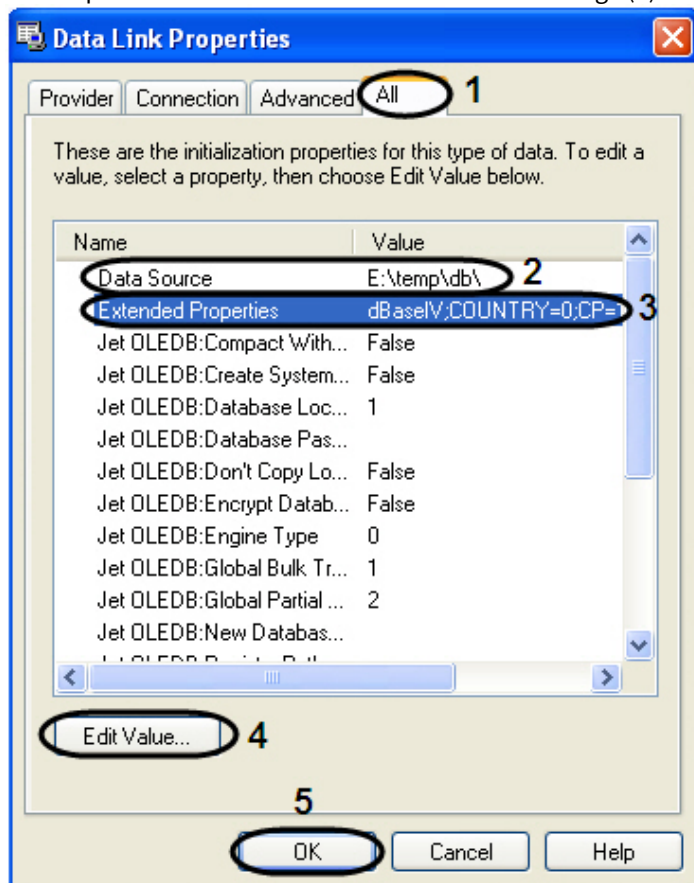

- e. In the value range **Extended Properties** state **dBase IV;COUNTRY=0;CP=1252;LANGID=0x0409** (3).

Note.

The value **COUNTRY=0;CP=1252;LANGID=0x0409** is stated only in case of being stored in DOS- coding.

- f. To change the property value click the **Change value...** button (4).
 g. In the opened **Edit property value** window enter the changes in the **Property value** field (1).
 h. Click **Ok** to save the changes (2).

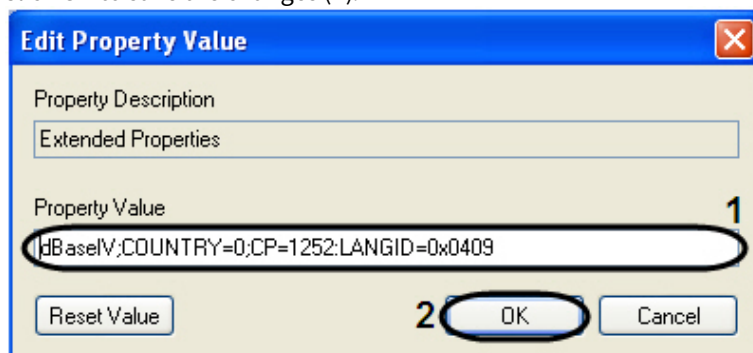

- i. Click **OK** to close the window **Edit property value** (5).

As the result the External Plates Database in "dbf" format has been setup.

6.6 Appendix 6. The Debug windows

6.6.1 ULPR server debug window

The **ULPR server debug window** is designed for operation control and debugging of the **LPR channel** object registered in the system.

6.6.1.1 The launch of the ULPR server debug window

Attention!

The launch of the debug window is possible only if the **Debug mode** is enabled (for more details, see [Enabling the Debug window](#)).

The launch of the ULPR server debug window is carried out from the notification area on the Windows taskbar. To launch the Debug window, it is necessary to click twice on the sign with the left-mouse  button.

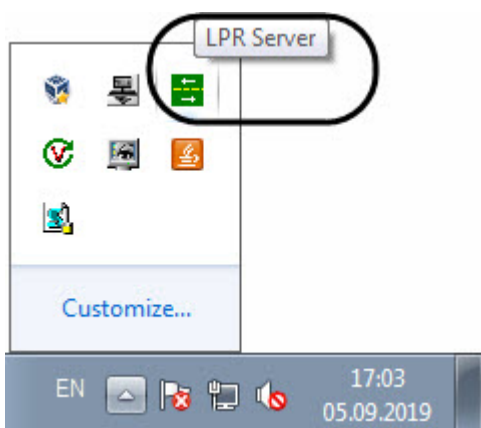

As a result, the **ULPR server** window will open.

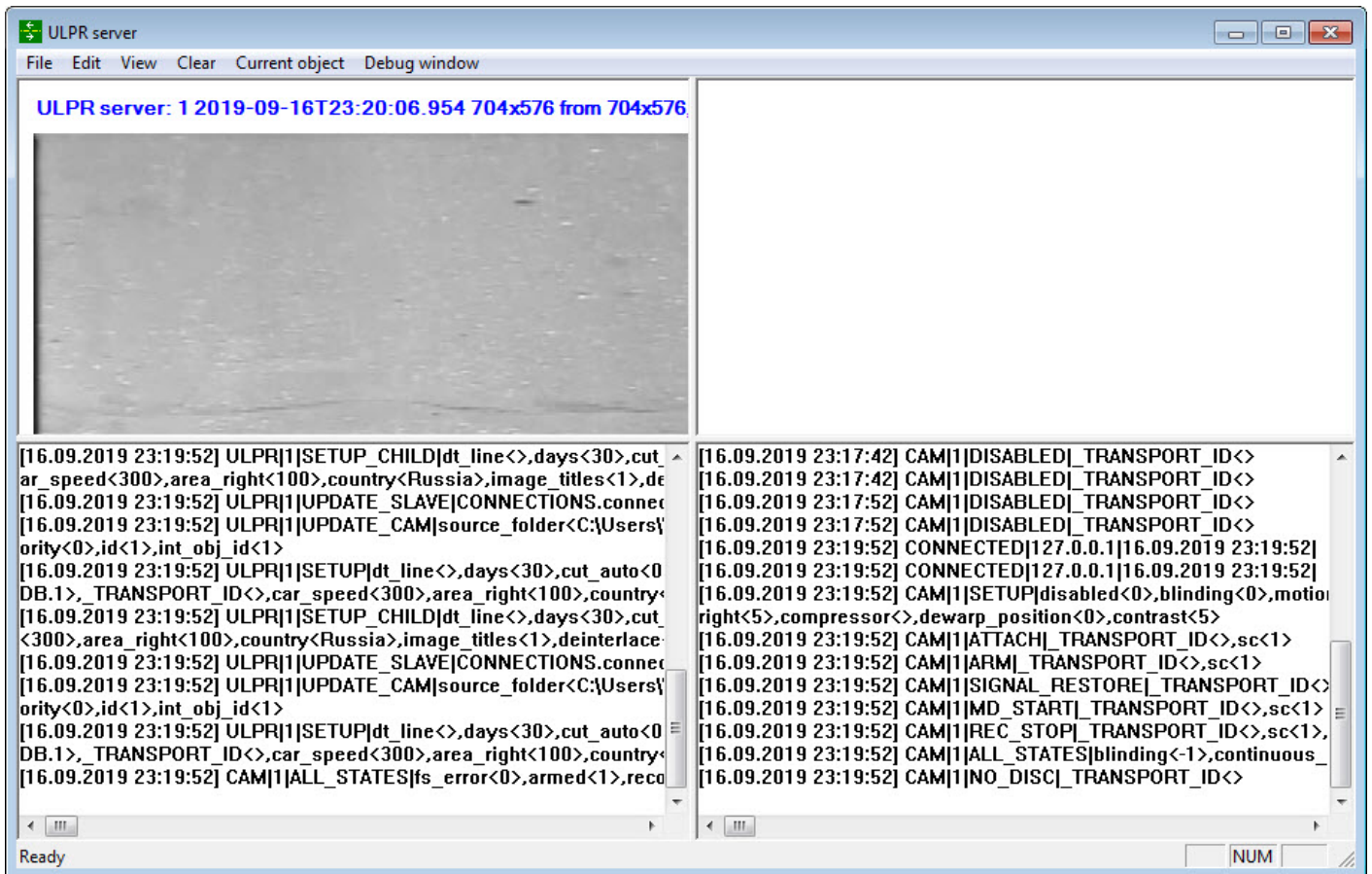

6.6.1.2 The ULPR server debug window interface

The **ULPR server** debug window contains the interface components described in the table below.

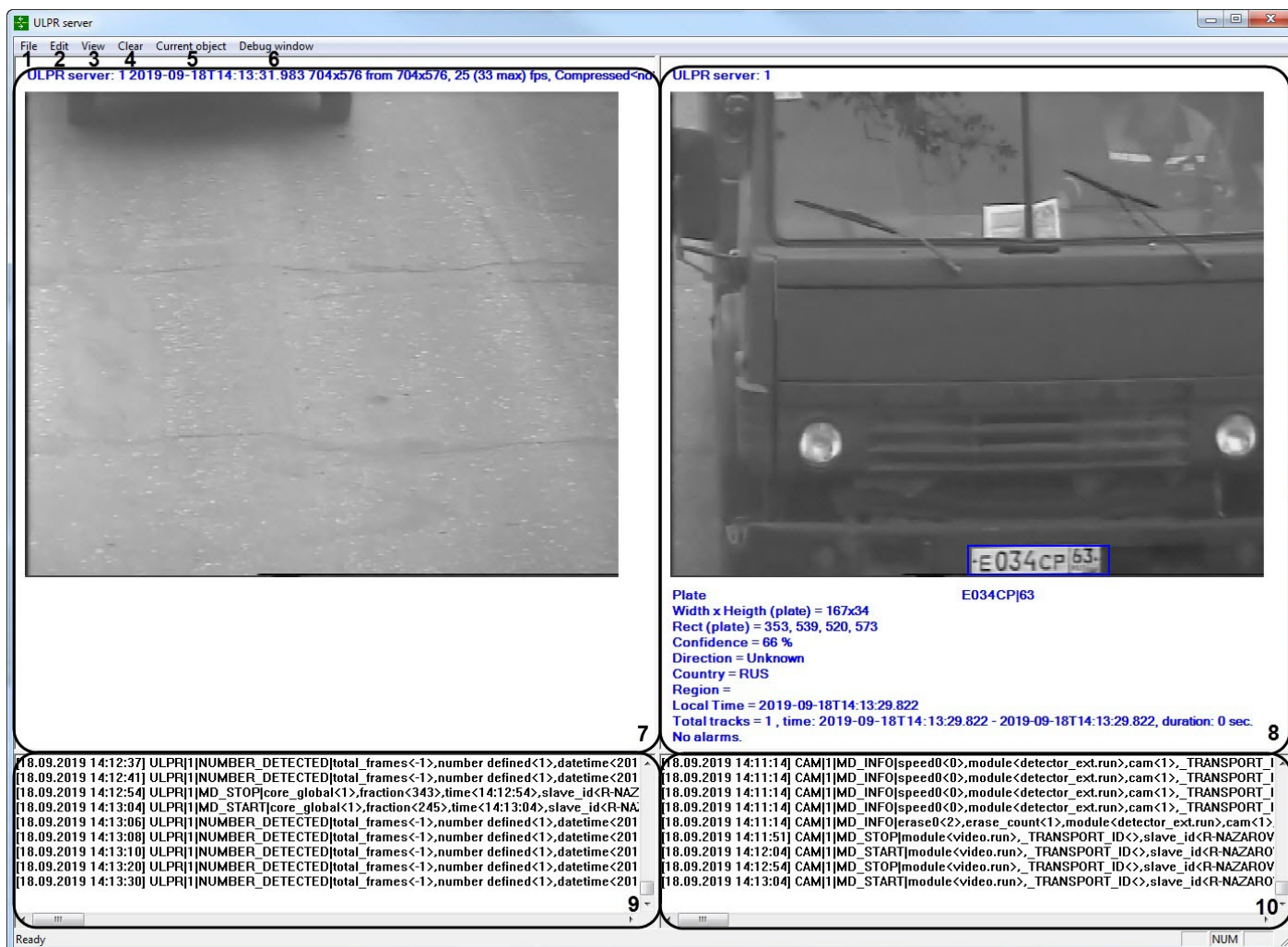

Number	Name	Description
1	The File menu	Access to the Edit Nearest Time button (see Editing the Nearest Time for the specified remote recognition module) Access to the Exit button
2	The Edit menu	Access to the operations with text Access to the Force clear database button (see The forced clearing of the license plate numbers database)
3	The View menu	Access to the Status bar button used to display or hide the status bar of the Debug window in the lower part of the window
4	The Clear button	Clearing all areas
5	The Current object menu	Access to the selection of the LPR channel with which the operation will be carried out
6	Debug window	-
7	The preview area of the video image from the camera	The video image from the camera and the data on the video stream are displayed in this area

8	The preview area of the frame with the last detected vehicle	The frame with the information on the last detected vehicle is displayed in this area
9	The preview area of the events from the LP recognition channel	The events of the LPR channels are displayed in this area For the NUMBER_DETECTED event to include the entire frame (the image parameter) and the cropped enlarged part with the number (the image_plate parameter), encoded using Base64, you must set the 1 value in the string parameter of the PicturesInNumberDetectedEvent registry key (see Vertical solutions)
10	The preview area of the events from cameras	The events from cameras are displayed in this area

6.6.1.3 The operations in the ULPR server debug window

6.6.1.3.1 The forced clearing of the license plate numbers database

To force the clearing of the license plate numbers database, it is necessary to select the **Force clear database** option in the **Edit** menu in the **ULPR server** Debug window.

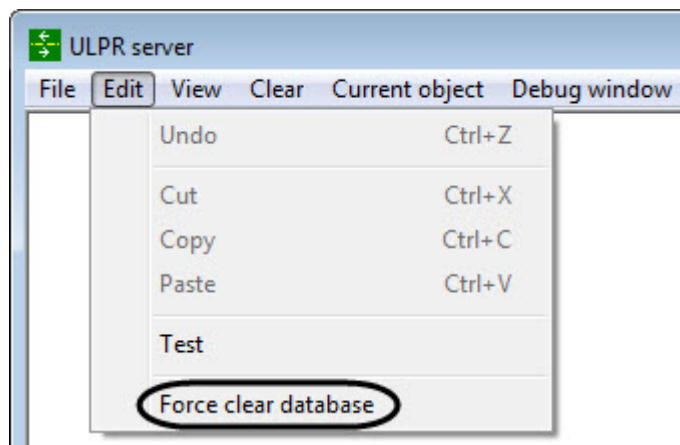

As a result of executing this procedure, all the license plates recognized earlier than the archive size allows (see [Configuring the database records retention period](#)) will be forcibly deleted from the Active Monitor database.

⚠ Attention!

- When the archive size is set to 1 day, all the records recognized earlier than a day before the launch of the forced database clearing will be deleted.
- The use of the **Force clear database** command does not physically reduce the size of the **LPREX** database.

The forced clearing of the license plate numbers database using the Debug window has been completed.

6.6.1.3.2 Editing the Nearest Time for the specified remote recognition module

To edit the **Nearest Time** for the specified LP recognition channel on which the remote recognition module is used, it is necessary to do the following:

1. Select the **LPR channel** object in the **Current object** menu in the **ULPR server** Debug window on which the remote recognition module is used.

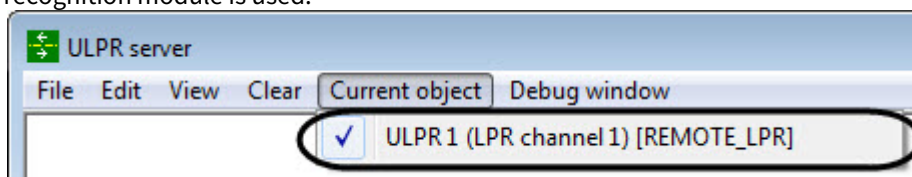

2. In the **File** menu of the **ULPR server** debug window, select the **Edit Nearest Time** option.

⚠ Attention!

This option is available only if the remote recognition module is used on the selected **LPR channel** object. Before setting up, it is necessary to synchronize the time of both the Server and the camera executing the LP recognition.

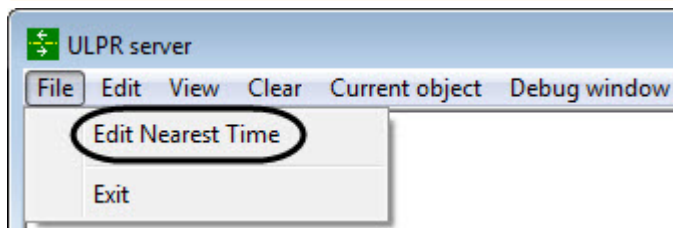

As a result, the **Edit Nearest Time** window will open.

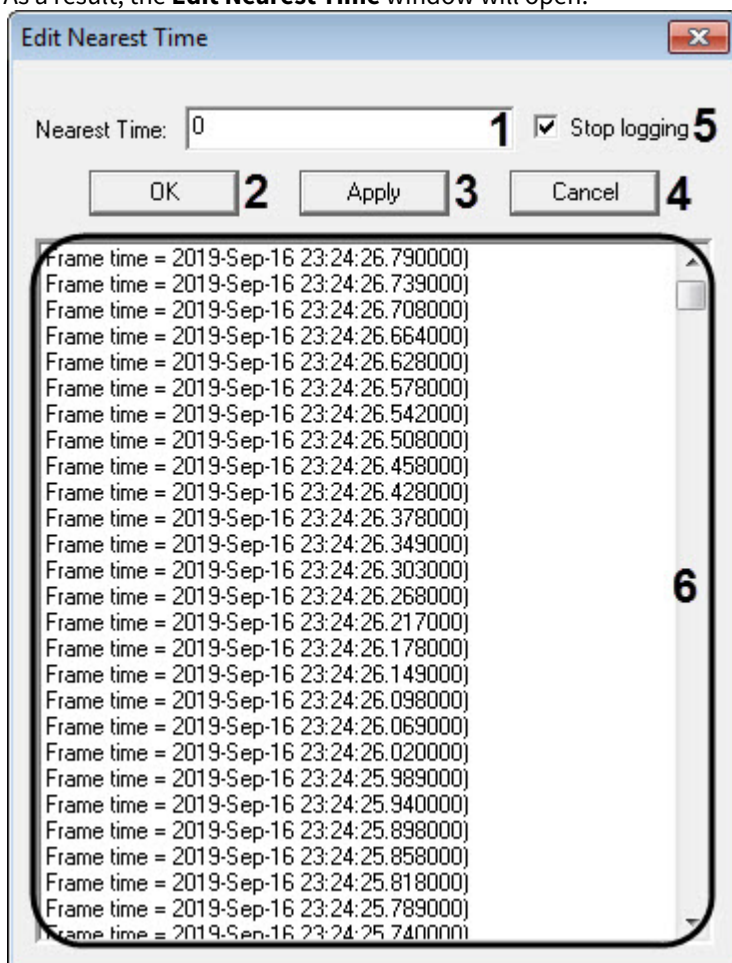

- In the **Nearest Time** (1) field, enter the time difference value between the moments of receiving the frame and event on the LP recognition.

i Note

To set up the optimum value, it is necessary to subtract the nearest frame time in the list (6) from the recognition event time and convert the achieved result to milliseconds.

- Click the **OK** button (2) to apply the changes and write the specified value in the Windows registry.

i Note

- Click the **Apply (3)** button to apply the changes, but the specified value will not be written in the Windows registry.
- Click the **Cancel (4)** button to cancel the changes. If the specified value differs from the registry one, the dialog box will open. In this dialog box, you need to click **Yes** if it is necessary to apply the changes and write the specified value in the Windows registry. Otherwise, click **No**.

5. Set the Stop logging (5) check box if it is necessary to stop the time logging of all the received frames from the camera and the recognition time which are displayed in the area (6).

 **Note**

The time difference in milliseconds between the moments of receiving the frame and event on the LP recognition is approximate and varies from event to event with the same **Nearest time** value.

The **Nearest time** editing for the specified remote recognition module has been completed.

6.6.2 UrlServer debug window

6.6.2.1 The launch of the UrlServer debug window

 **Attention!**

The launch of the debug window is possible only if the **Debug mode** is enabled (for more details, see [Enabling the Debug window](#)) and the **UrlServerFrameBuffer** registry key value is not **0** (for details, see [Registry keys reference guide](#), for more information about working with the registry, see [Working with Windows OS registry](#)).

The launch of the UrlServer debug window is carried out from the notification area on the Windows taskbar. To launch the Debug window, it is necessary to click twice on the sign with the left-mouse  button.

As a result, the **UrlServer** window will open.

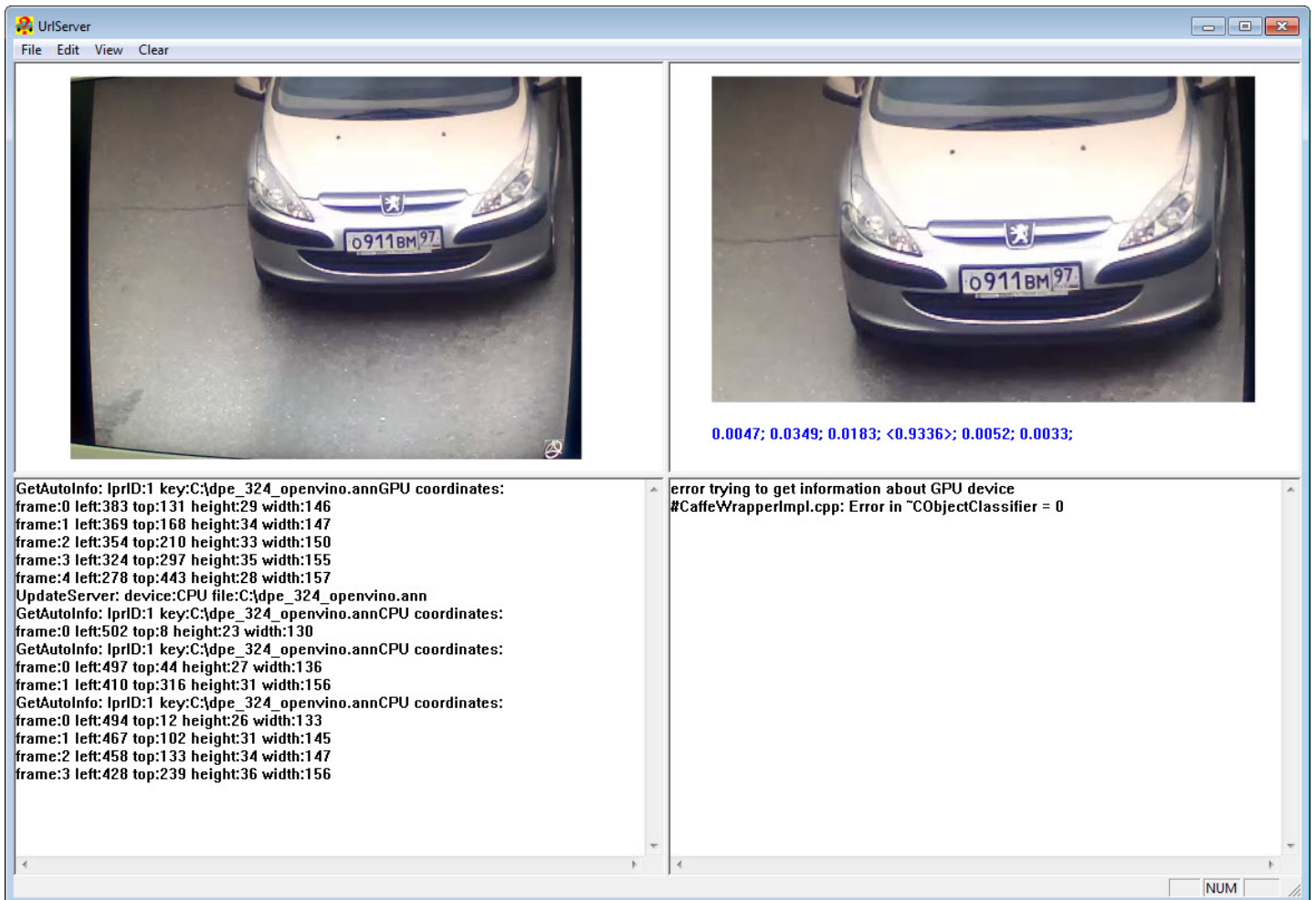

6.6.2.2 The UrlServer debug window interface

The **UrlServer** Debug window contains the interface components described in the table below.

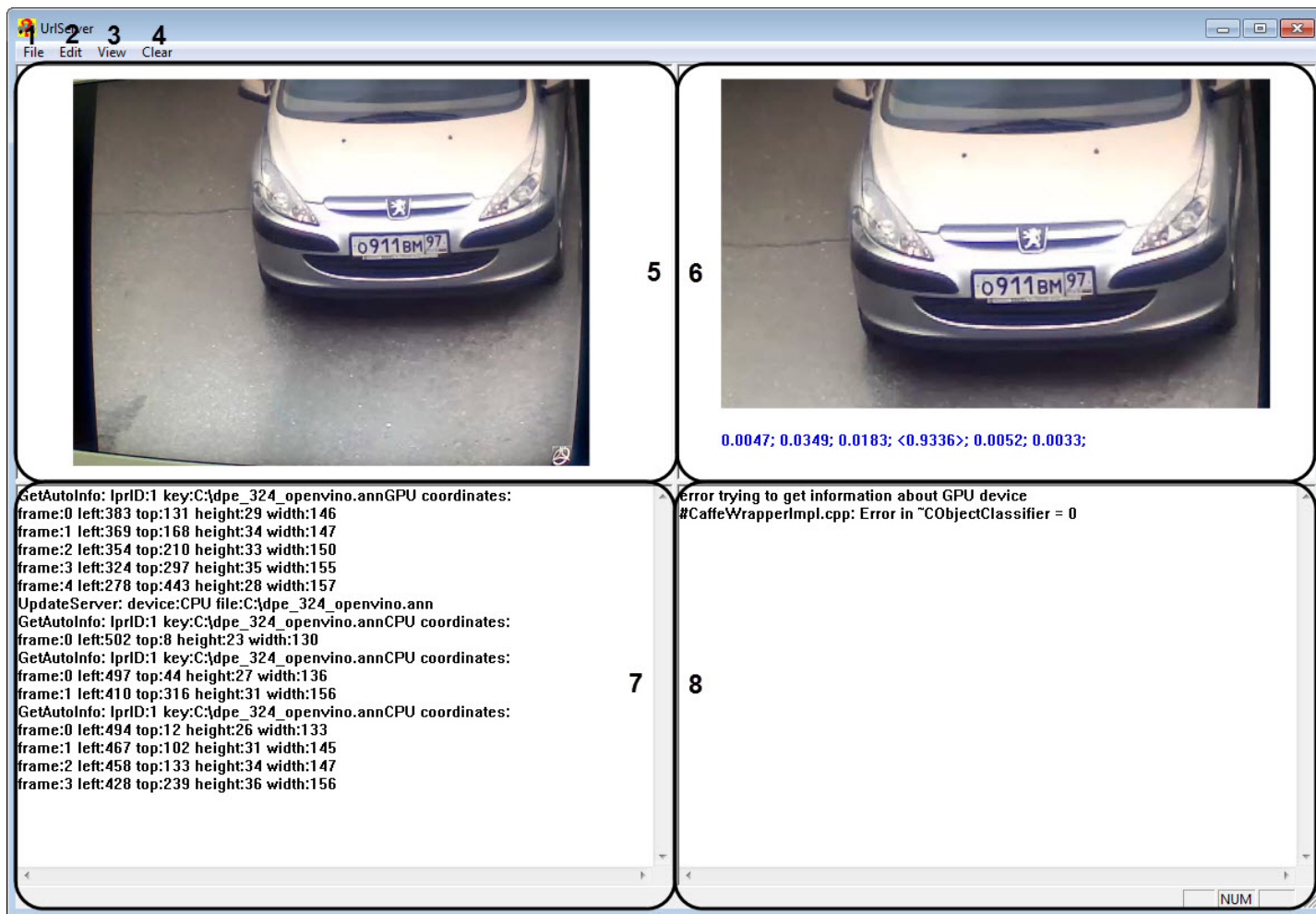

Number	Name	Description
1	File menu	Access to the Exit button
2	Edit menu	Access to the operations with text
3	View menu	Access to the Status Bar button, designed to show or hide the debug window status panel at the bottom of the window
4	The Clear button	Clearing all areas
5	The preview area of a frame from the camera	In this area, the video image from the camera received by the UrlServer module is displayed.
6	The preview area of a frame prepared for recognition	In this area, the frame prepared for recognition and information on the results of recognition of this frame are displayed.
7	The preview area of POST requests from UrmLpr	In this area, all processed POST requests from UrmLpr are displayed.
8	The preview area of error events	In this area, all errors that are written to the log file are displayed.

6.7 Appendix 7. The utilities description to work with Auto-Intellect software

6.7.1 The utilities to work with AUTO-Uragan recognition module

6.7.1.1 KeyInfo.exe utility for reading the Uragan keys

6.7.1.1.1 General information about the KeyInfo.exe utility

The KeyInfo.exe utility is designed for checking the configuration of the current Guardant hardware protection key.

6.7.1.1.2 Starting and closing the utility

To start the KeyInfo.exe utility, do one of the following:

1. Start the utility from the **Start** menu. Click **Start -> Programs -> Intellect -> Tools -> Uragan keys reading**.
2. Start the KeyInfo.exe executive file in the *<Auto Intellect installation directory>\Modules64\UrmLpr\Auto_uragan\UrmSDK<SDK version>\KeyInfoBin* catalogue.

The **KeyInfo** dialog box will open.

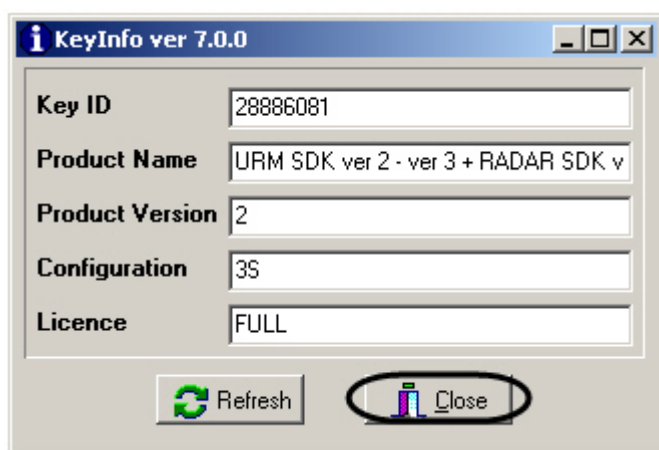

To close the utility click **Close**.

6.7.1.1.3 Using the KeyInfo.exe utility

The KeyInfo.exe utility allows checking the configuration of the current Guardant hardware protection key. The following information is displayed in the utility window:

1. The unique key identifier in the **Key ID** field (1).

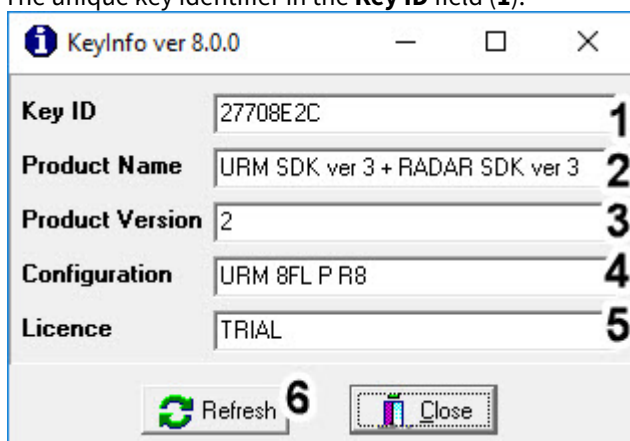

2. The product name in the **Product Name** field (2).
3. The key version in the **Product Version** field (3).
4. The key configuration in the **Configuration** field (4). Decryption of the main values that can be used in the license key:

- **URM** - module name.
 - **R** - displays the maximum number of radars that can be connected to the **Auto-URAGAN** software module.
 - **F** - displays the maximum number of "fast traffic" lanes (for roads with free passage of vehicles, without checkpoints, barriers, etc.), on which you can configure LP number detection.
 - **S** - displays the maximum number of "slow traffic" lanes (for roads with limited traffic, with checkpoints, barriers, etc.), on which you can configure the LP number detection.
 - License for simultaneous work with different sizes. If there is the **L** symbol, then the key allows simultaneous operation of different sizes. If there is no **L** symbol, then the key allows the operation of only one standard size.
 - **VS** - displays the maximum number of lanes on which speed measurement by video is available.
 - **P** - pattern recognition of all countries. In older versions, there may be **C1** - all countries except the countries of North and South America.
 - **CAC** - support for iris control.
 - **PAD** - support for fixing violations at the pedestrian crossing (not providing benefits to the pedestrian).
 - **TL** - support for fixing violations at the intersection (crossing the intersection on the red traffic light, leaving the stop line on the red traffic light).
 - **VIOL** - support for fixing violations of road marking and signs non-compliance.
 - **AVS** - support for fixing speeding violations on a road section.
 - **WSD** - support for determining the type of vehicle and detecting the windshield of the vehicle.
5. The license type in the **License** field (5).
 6. To update the information displayed in the utility window, click **Refresh** (6).

6.7.1.2 PatCfgr.exe utility for active patterns configuration of Auto-URAGAN module

6.7.1.2.1 General information about PatCfgr.exe utility

PatCfgr.exe utility is designed for creating, editing and removing configurations. Configuration in this case means the set of templates using at plates recognizing.

The configuration changing is possible after the updating of hardware protection key (see [RTKeyUpdate.exe utility for updating the Uragan keys](#)).

Attention!

Close the *Auto-Intellect* software before the configuration changing.

6.7.1.2.2 Starting and closing the PatCfgr.exe utility

You can launch the PatCfgr.exe utility in one of the following ways:

1. From the **Start** menu.
 - To configure the SDK templates for version 3.5, click **Start** menu -> **Intellect** -> **Utilities** -> **Uragan Pattern Configurator 3.5**.
 - To configure the SDK templates for version 3.7, click **Start** menu -> **Intellect** -> **Utilities** -> **Uragan Pattern Configurator 3.7**.
2. From the *Auto-Intellect* software installation directory.
 - For SDK version 3.5: <Intellect installation directory>\Modules\UrmLpr\Auto_uragan\Bin\PatCfgr.exe
 - For SDK version 3.7: <Intellect installation directory>\Modules64\UrmLpr\Auto_uragan\UrmSDK<SDK version>\PatCfgr\Bin\PatCfgr.exe

After starting the PatCfgr.exe utility, the **Active pattern configurator** window will open.

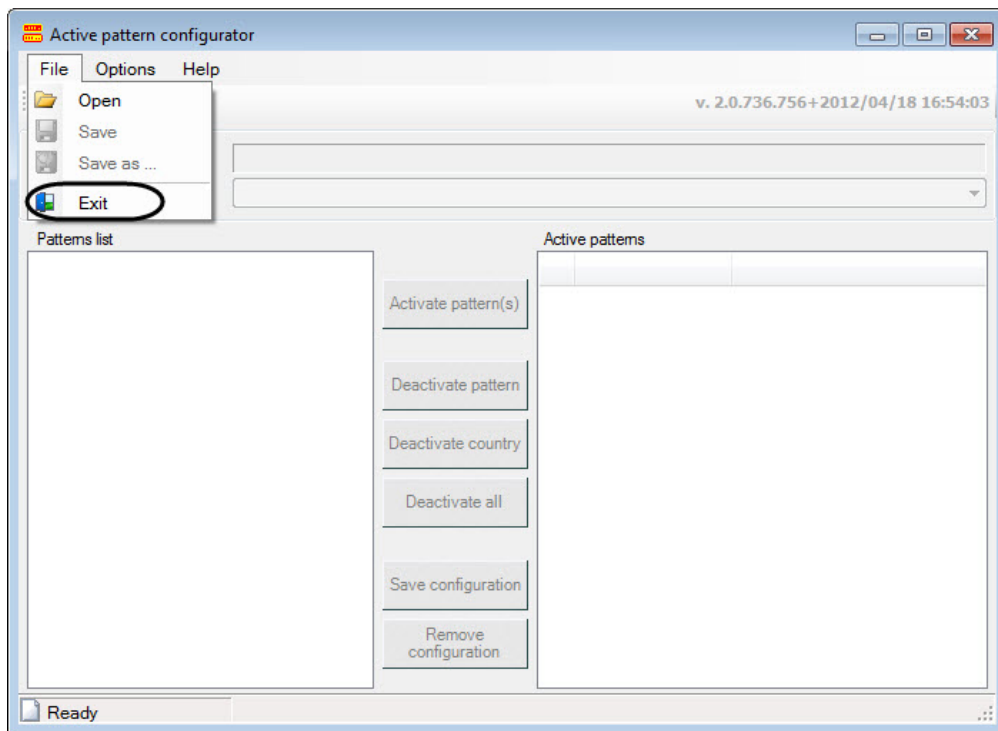

Note.

To change the language of PatCfgr.exe utility interface, do the following:

1. Select **Language** from **Settings** menu.

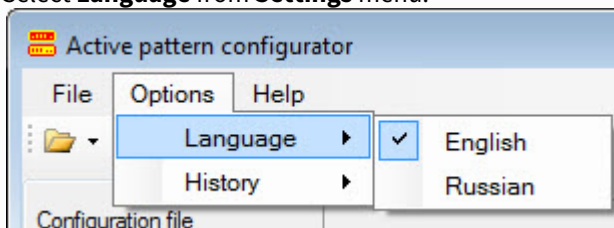

2. Select the needed interface language.

Click the  button or select **Exit** from **File** menu to close the PatCfgr.exe utility.

6.7.1.2.3 Using the PatCfgr.exe utility

6.7.1.2.3.1 Open the configuration

To open the configuration, do the following:

1. Select **Open** from **File** menu to open the configuration file.

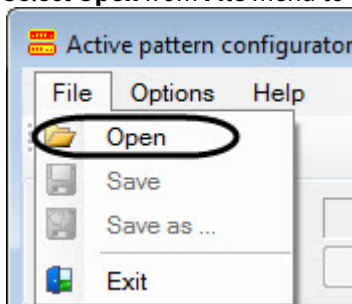

Important!

The location of the PpmCfg.dat configuration file depends on the current SDK version (see [Setting up the AUTO-Uragan module](#)):

- For SDK ver. 3.5: <Intellect installation folder>\Modules\UrmLpr\Auto_uragan\Data\PpmCfg.dat
- For SDK ver. 3.7: <Intellect installation folder>\Modules64\UrmLpr\Auto_uragan\UrmSDK<SDK version>\Data\PpmCfg.dat

2. Select the needed configuration from the **Available configurations** drop-down list (1).

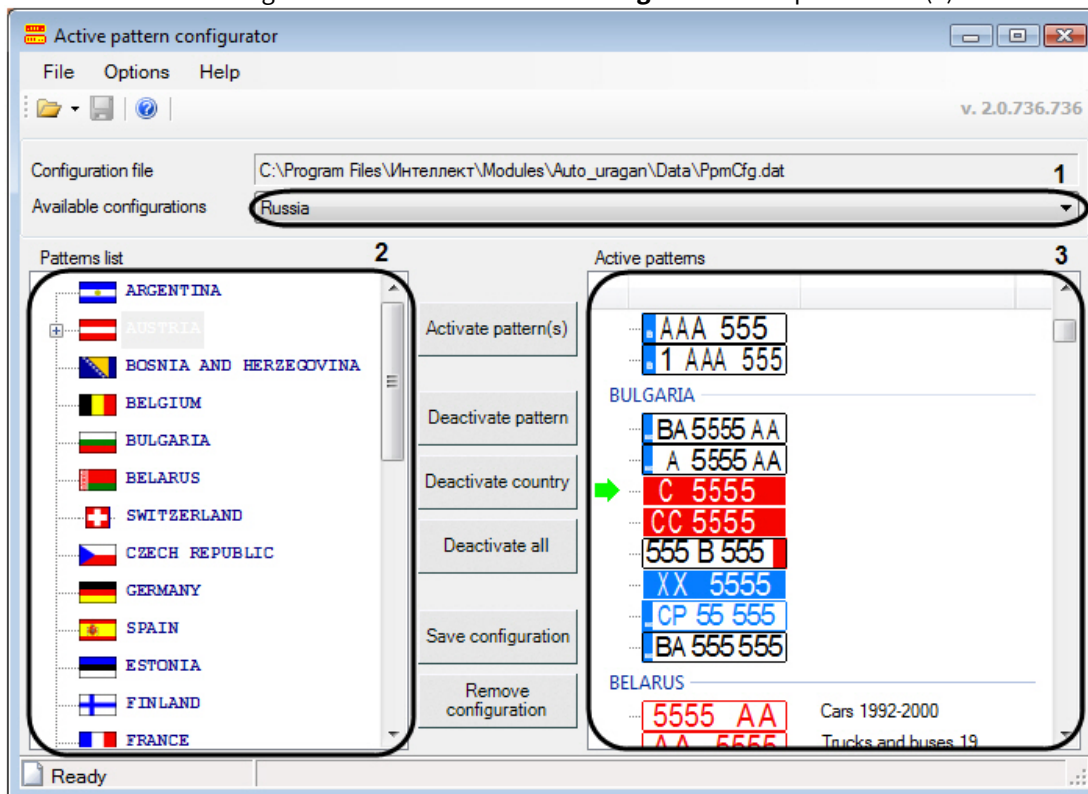

3. List of patterns will be displayed in the **Pattern list** field (2).
4. Pattern list of selected configuration will be displayed in the **Active patterns** field (3).

Configuration opening is completed.

6.7.1.2.3.2 Edit the list of configuration patterns

To edit the list of configuration patterns, do the following:

1. Select the pattern in the pattern list and click **Activate pattern(s)** to add it to configuration (1). If the country is selected in the Patterns list, all patterns of this country will be added to the list of active patterns.

Attention!

Maximum number of countries in configuration is 8.

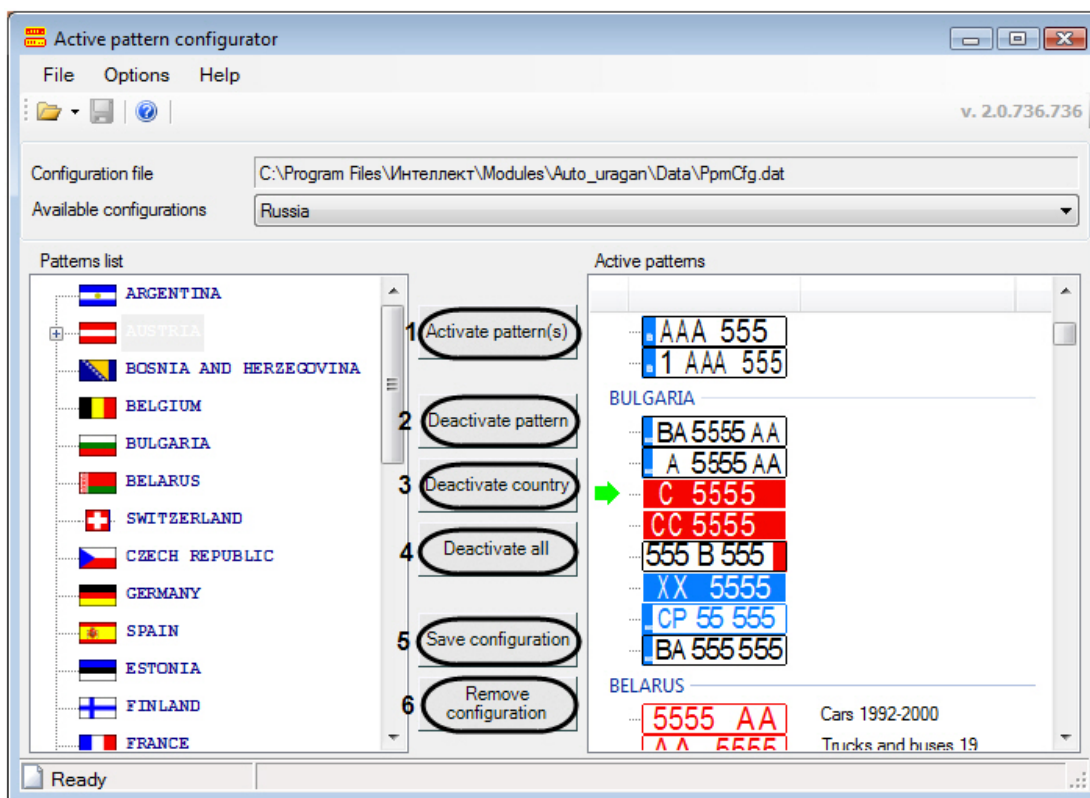

2. Select the pattern and click **Deactivate pattern** to remove it from the list of active patterns (2).

Note.

Selected pattern is marked by sign  .

3. Select the pattern of some country and click **Deactivate country** to remove all patterns of this country from the list of active patterns (3).
4. Click **Deactivate all** to clear the list of active patterns (4).
5. Click **Save configuration** to save all changes made in configuration (5).
6. Click **Remove configuration** to remove selected configuration from the configuration file (6).

Editing the list of configuration patterns is completed.

6.7.1.3 RTKeyUpdate.exe utility for updating the Uragan keys

6.7.1.3.1 General information about the RTKeyUpdate.exe utility

The RTKeyUpdate utility is designed for the Guardant hardware protection key update. New update allows starting the templates configurator and licensing the different plate types and sizes.

Before starting the RTKeyUpdate.exe utility make sure that the key to be updated is connected to the Server.

6.7.1.3.2 Starting and closing the RTKeyUpdate.exe utility

Start the RTKeyUpdate.exe utility in the <Auto Intellect installation directory>\Modules\UrmLpr\Auto_uragan\Bin\ folder.

The **RTKeyUpdate** window will open.

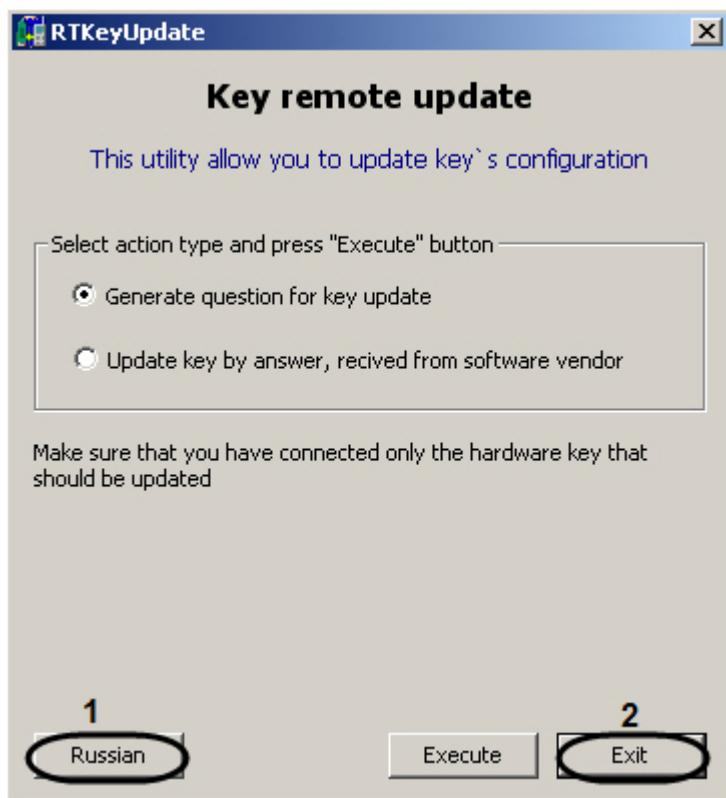

Note.
Click **Russian** to switch the utility language to Russian (1).

To close the RTKeyUpdate.exe utility click **Exit** (2).

6.7.1.3.3 Using the RTKeyUpdate.exe utility

6.7.1.3.3.1 Generation the query file for key updating

To generate the request file for key update, do the following:

1. Launch the RTKeyUpdate.exe utility.

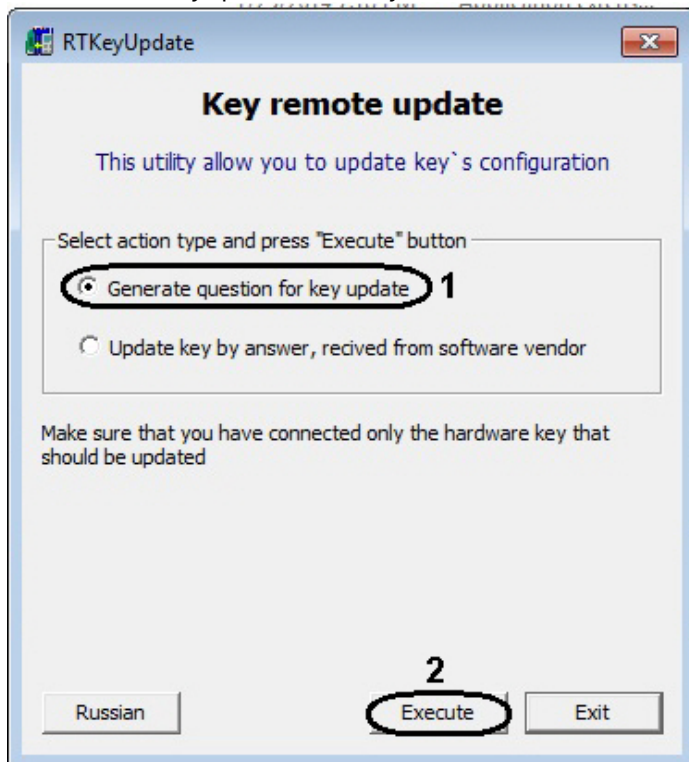

2. Set the **Generate question for key update** checkbox (1).
3. Click **Execute** (2).
4. Select the folder for saving the request file in catalogues tree (1).

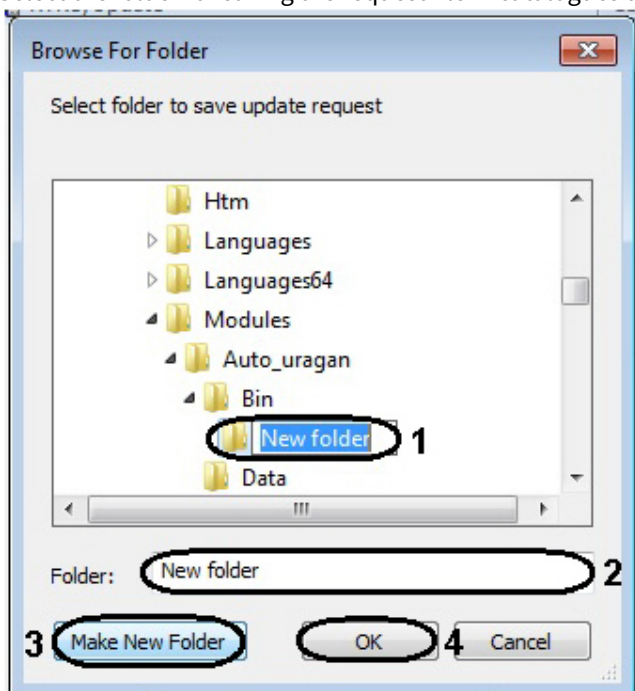

Note.

To create the query file in New folder, do the following:

- a. Enter the folder name in the **Folder:** field (2).
- b. Click **Create folder** (3).

5. Click **OK** (4).

The message about successful saving the request file will be displayed.

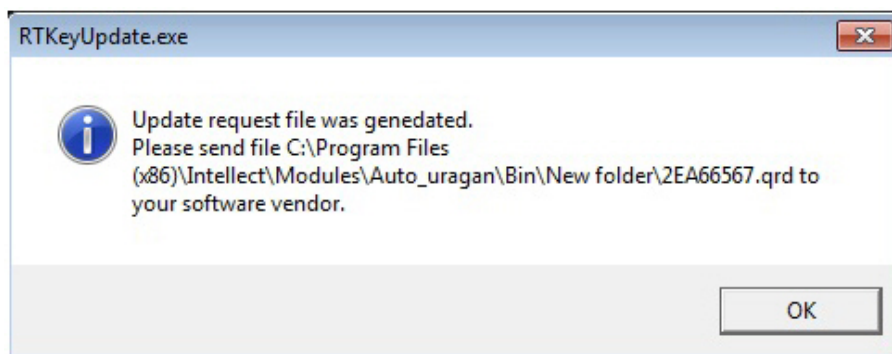

The request file generation is completed.

After the request file is generated send it to the manager of AxxonSoft company with whom the update has been agreed and wait for the dmp-file.

6.7.1.3.3.2 Key update by answer received from software vendor

The key is updated after receiving the dmp-file from the manager of AxxonSoft company. To update the key, do the following:

1. Launch the RTKeyUpdate.exe utility.

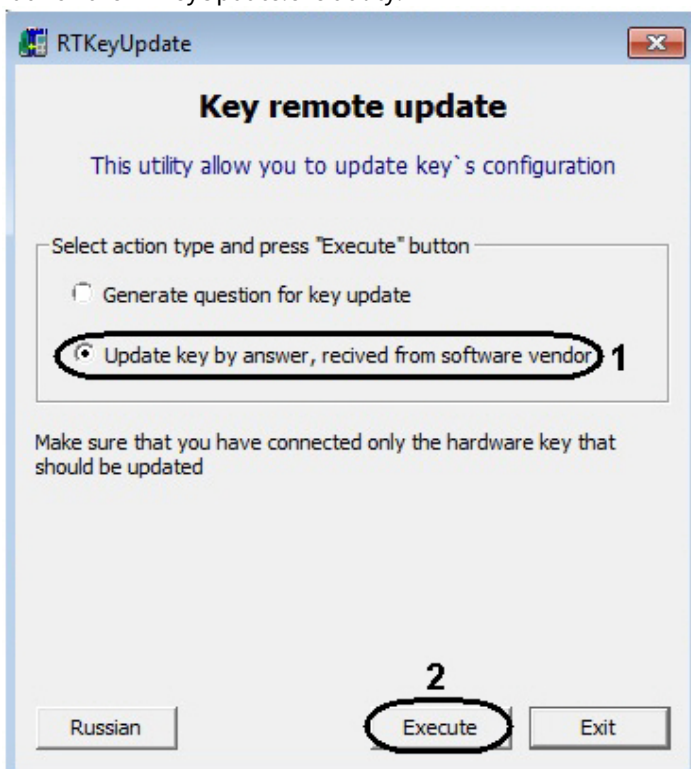

2. Set the **Update key by answer received from software vendor** checkbox (1).
3. Click **Execute** (2).

- Specify the dmp-file that has been sent by manager using the standard dialog of file opening.

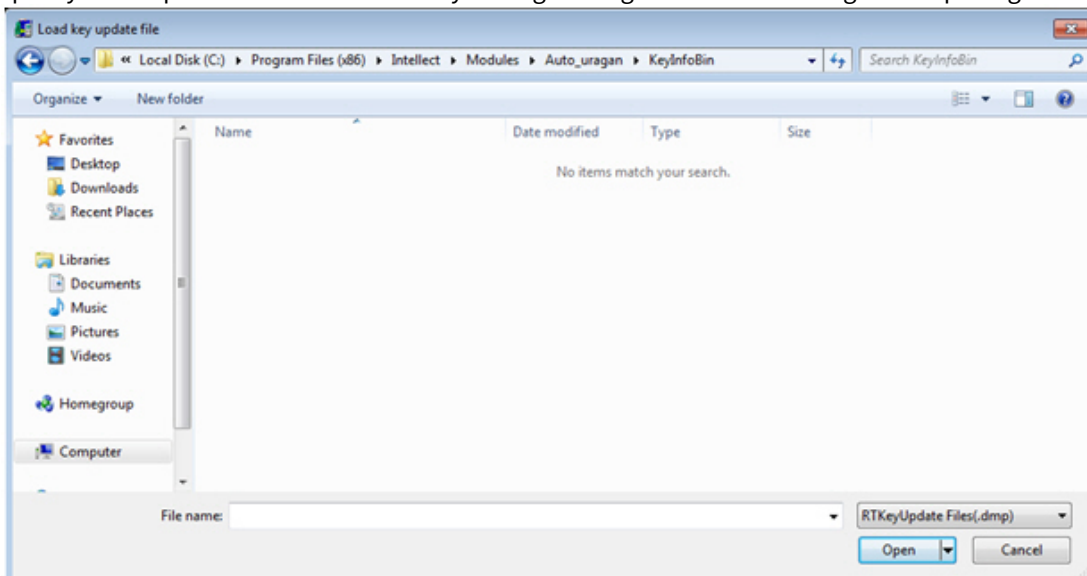

The update validation can be performed using the KeyInfo.exe utility (see [KeyInfo.exe utility for reading the Uragan keys](#) section). The key update by answer received by software vendor is completed.

6.7.2 The utilities to work with VIT recognition module

6.7.2.1 LicenceViewer.exe utility for reading the VIT keys

6.7.2.1.1 General information about the LicenceViewer.exe utility

The LicenceViewer.exe utility is designed for checking the configuration of the current Hasp hardware protection key.

6.7.2.1.2 Starting and closing the LicenceViewer.exe utility

To start the LicenceViewer.exe utility, do one of the following:

- Start the utility from the **Start** menu. Click **Start -> Programs -> Intellect -> Tools -> VIT keys reading**. Start the KeyInfo.exe executive file from the *Auto-Intellect* software installation directory in the *<Auto Intellect installation directory>\Modules\UrmLpr\VIT_<SDK version>\LicenseViewer* catalogue.

The **LicenceViewer** dialog box will open.

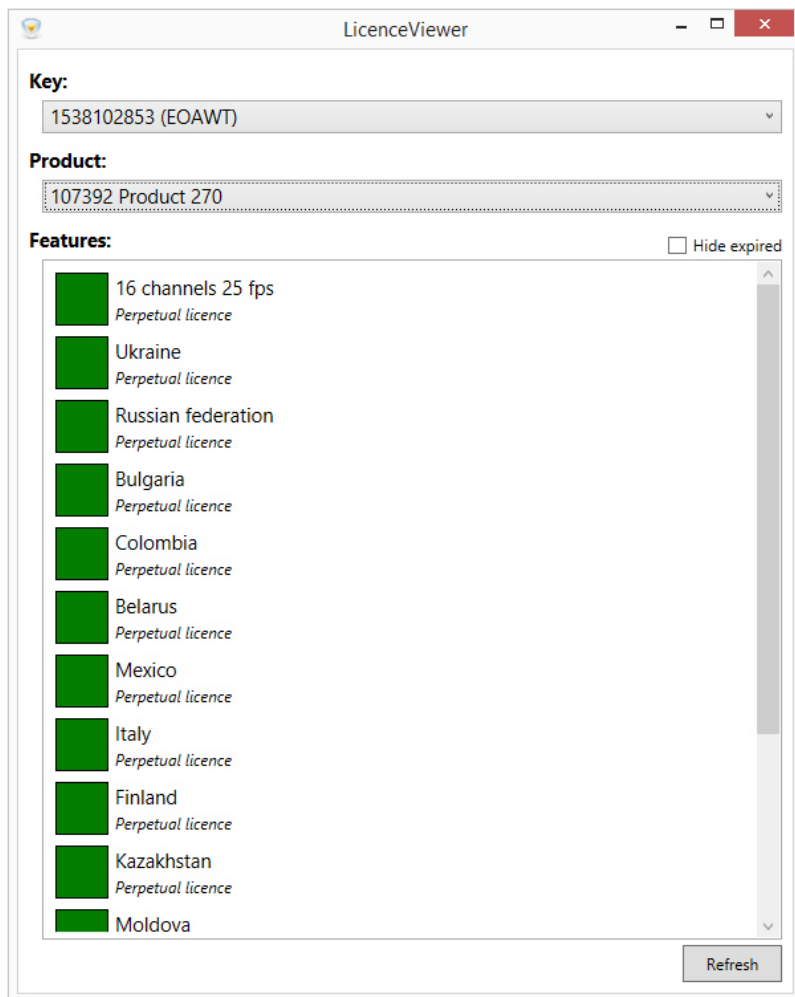

To close the utility click  .

6.7.2.1.3 Using the LicenceViewer.exe utility

The LicenceViewer.exe utility allows checking the configuration of the current Hasp hardware protection key. The following information is displayed in the utility window:

1. The unique key identifier in the **Key** field (1).

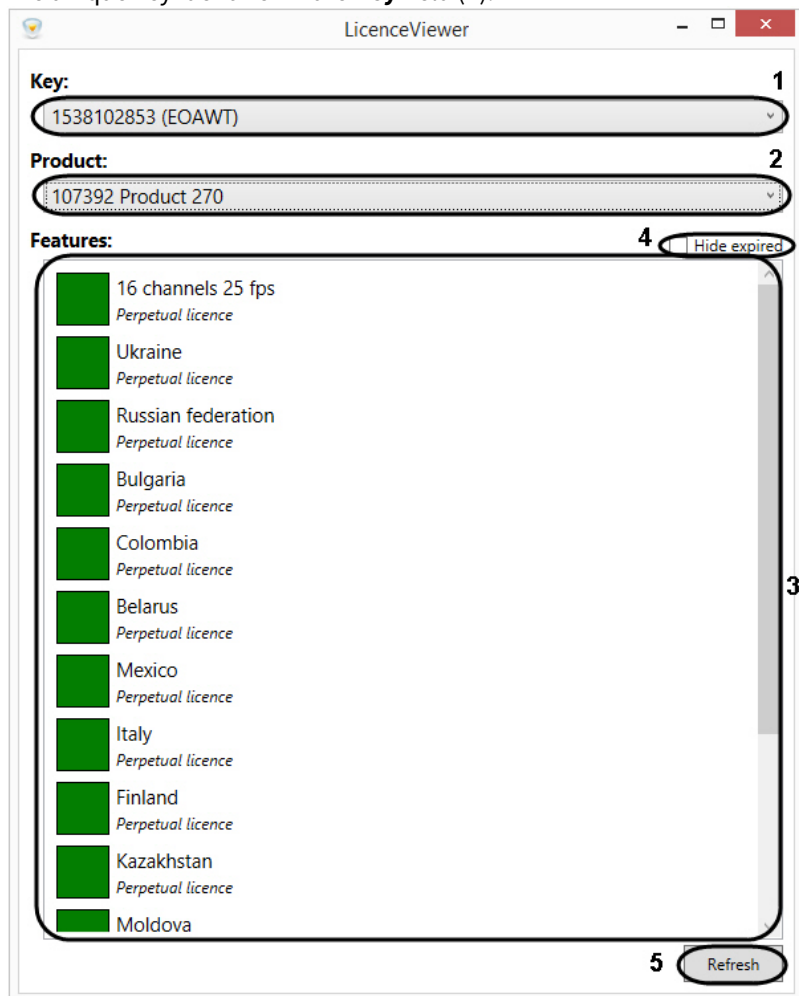

2. The product name in the **Product** field (2).
3. Functional modules supported by the key in the **Functional modules** (3).

To hide expired functional modules, set the **Hide expired** checkbox (4).

To update the information displayed in the utility window click **Refresh** (5).

6.7.2.2 PresetEditor.exe utility for active patterns configuration of VIT module

6.7.2.2.1 General information about PresetEditor.exe utility

PresetEditor.exe utility is designed for creating, editing and removing template configurations which will be used for LP recognizing using the **VIT** module.

6.7.2.2.2 Starting and closing the PresetEditor.exe utility

To start the PresetEditor.exe utility, do the following:

1. Start the utility from the Start menu. Click **Start -> Programs -> Intellect -> Utilities -> VIT Pattern Configurator**.
2. Start the PatCfgr.exe executive file in the `<Auto Intellect installation directory>\Modules\UrmLpr\VIT_<SDK version>\PresetEditor` catalogue.

The following window will open.

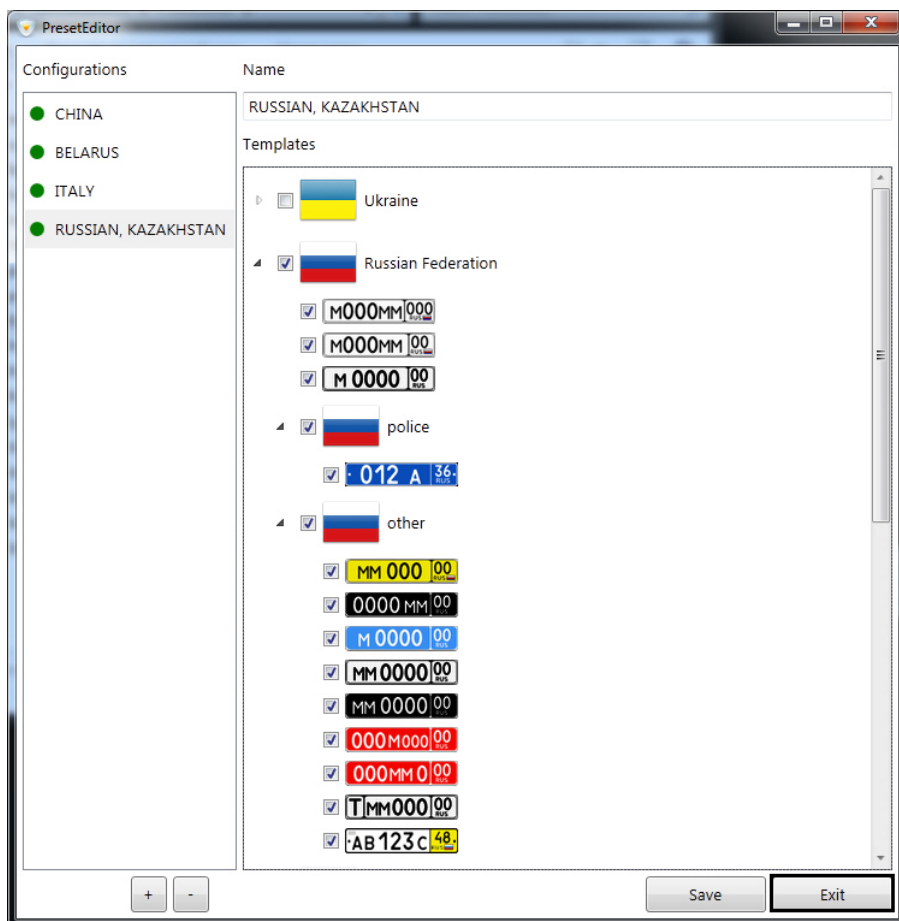

Click the **Exit** button or  button to close the PresetEditor.exe utility.

6.7.2.2.3 Using the PresetEditor.exe utility

Attention!

To ensure the proper operation of the PresetEditor.exe utility, it is necessary to grant the read/write access for the current Windows user to the following files:

- <Auto Intellect installation directory>\Modules\UrmLpr\VIT_<SDK version>\PresetEditor\features.EOAWT.xml
- C:\ProgramData\VIT\LprPresetDemo\presets.xml

The PresetEditor.exe allows creating and editing of template configurations which are used for LP recognition using the VIT recognition module.

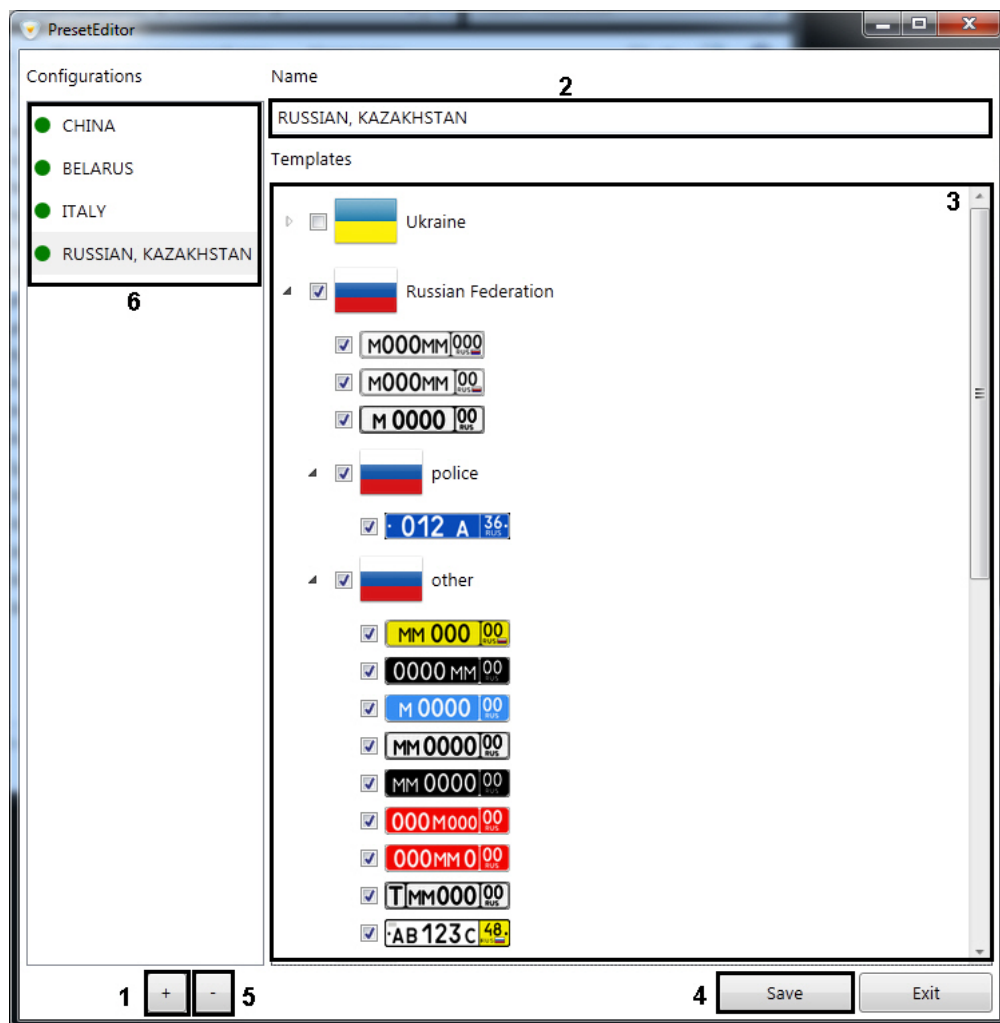

To create a template configuration, do the following:

1. Click the  button to create new configuration (1).
2. Enter a name of configuration in the field (2).
3. To add template to configuration set checkboxes close to corresponding template in the list (3). if the country is selected in the Templates list, all templates of this country will be added.
4. To save configuration click the **Save** button (4).

To remove configuration select the corresponding configuration from the list (6) and click the  button.

To edit existing configuration select it in the list (6) and repeat steps 3-4.

6.7.3 LprFsTool.exe utility for loading images of recognized license plates from database to disk

6.7.3.1 General information about the LprFsTool.exe utility

The LprFsTool.exe utility is designed for loading images of recognized license plates from the database to the disk.

6.7.3.2 Starting and closing the LprFsTool.exe utility

To start the *LprFsTool.exe* utility, start the *LprFsTool.exe* executive file located in the <Intellect installation folder>\Modules64.

When the utility is started the **License Plate Recognition Tool** window appears.

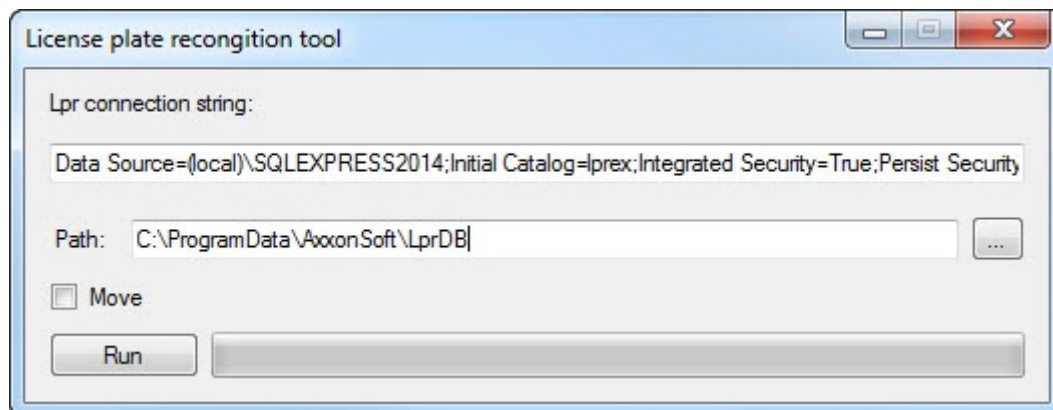

To close the utility click .

6.7.3.3 Using the LprFsTool.exe utility

Load images of recognized license plates from the database to the disk as follows:

1. In the **Lpr connection string** field (1) enter the connection string for the license plates database.
2. In the **Path** (2) field specify manually or using the button (3) the path to the folder where the images will be loaded to.

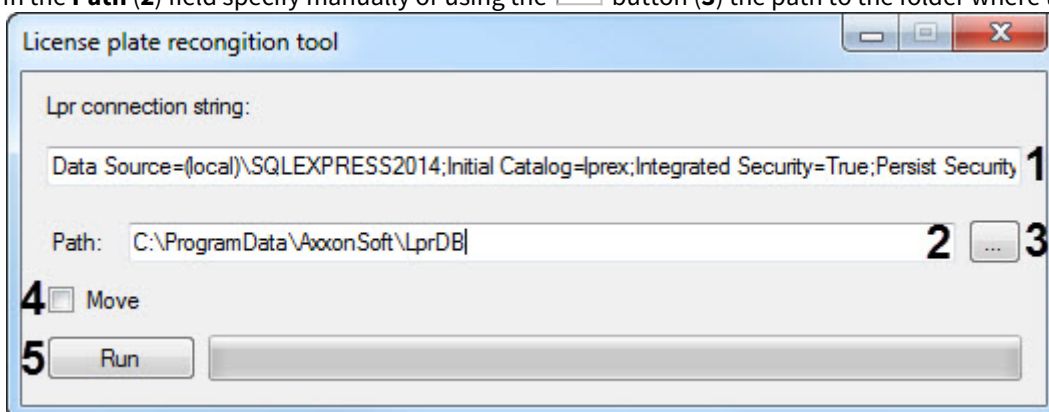

Info

If "user-defined text" is specified in the **Path** field, then the folder with this name will be created in the same folder where there is the utility.

3. Set the **Move** checkbox (4) checked if the images are to be deleted from the database after they are moved to the disk.

Info

If the **Move** checkbox is set unchecked, then the images are not deleted from the database after they are moved to the disk.

4. Click the **Run** button (5) to load the images to the specified folder. As a result the total images of recognized license plates loaded from the database are displayed.



6.7.4 TestAppTMD.exe utility for setting up the Intellivision vehicle detection

6.7.4.1 General information about TestAppTMD.exe utility and its licensing

6.7.4.1.1 General information about TestAppTMD.exe utility

The **TestAppTMD.exe** utility is designed for creating a settings file for the **Intellivision vehicle detection** module (see [Setting up the IntelliVision vehicle detection parameters](#)).

6.7.4.1.2 Licensing of the TestAppTMD.exe utility

To license the **TestAppTMD.exe** utility, it is necessary to run the **GetHardwareID.exe** utility on behalf of the administrator at `<Auto-Intellect installation directory>\Modules64\`, then copy and transfer the **HardwareID** to the AxxonSoft managers.



As a response, a **regkey.dat** file will be received. It is necessary to place it at: `<Auto-Intellect installation directory>\Modules64\`.

6.7.4.2 Starting and closing the TestAppTMD.exe utility

To start the **TestAppTMD.exe** utility, it is necessary to start the TestAppTMD.exe executive file located in the `<Auto-Intellect installation directory>\Modules64\`.

When the utility is started the **Traffic Monitor** window appears.

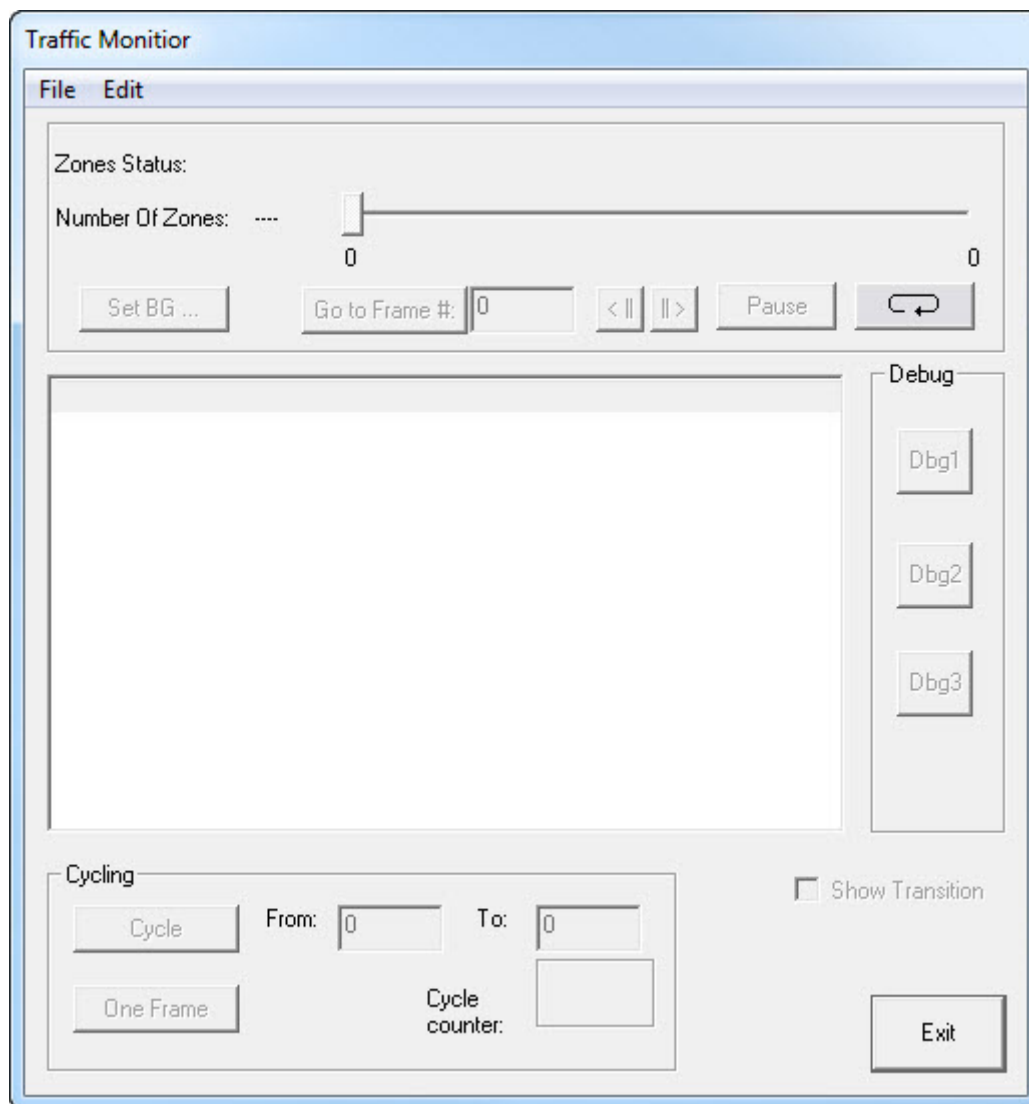

To close the utility, click

6.7.4.3 Using the TestAppTMD.exe utility

6.7.4.3.1 Opening a video file in TestAppTMD.exe utility

To start working with the **TestAppTMD.exe** utility, it is necessary to open a video file, on the template of which the **Intellivision vehicle detection** module will be configured.

Note

The video file should be obtained from the camera on which the **Intellivision vehicle detection** module will be configured.

To open a video file in the **TestAppTMD.exe** utility, do the following:

1. From the **File** menu, select **Open Video**.

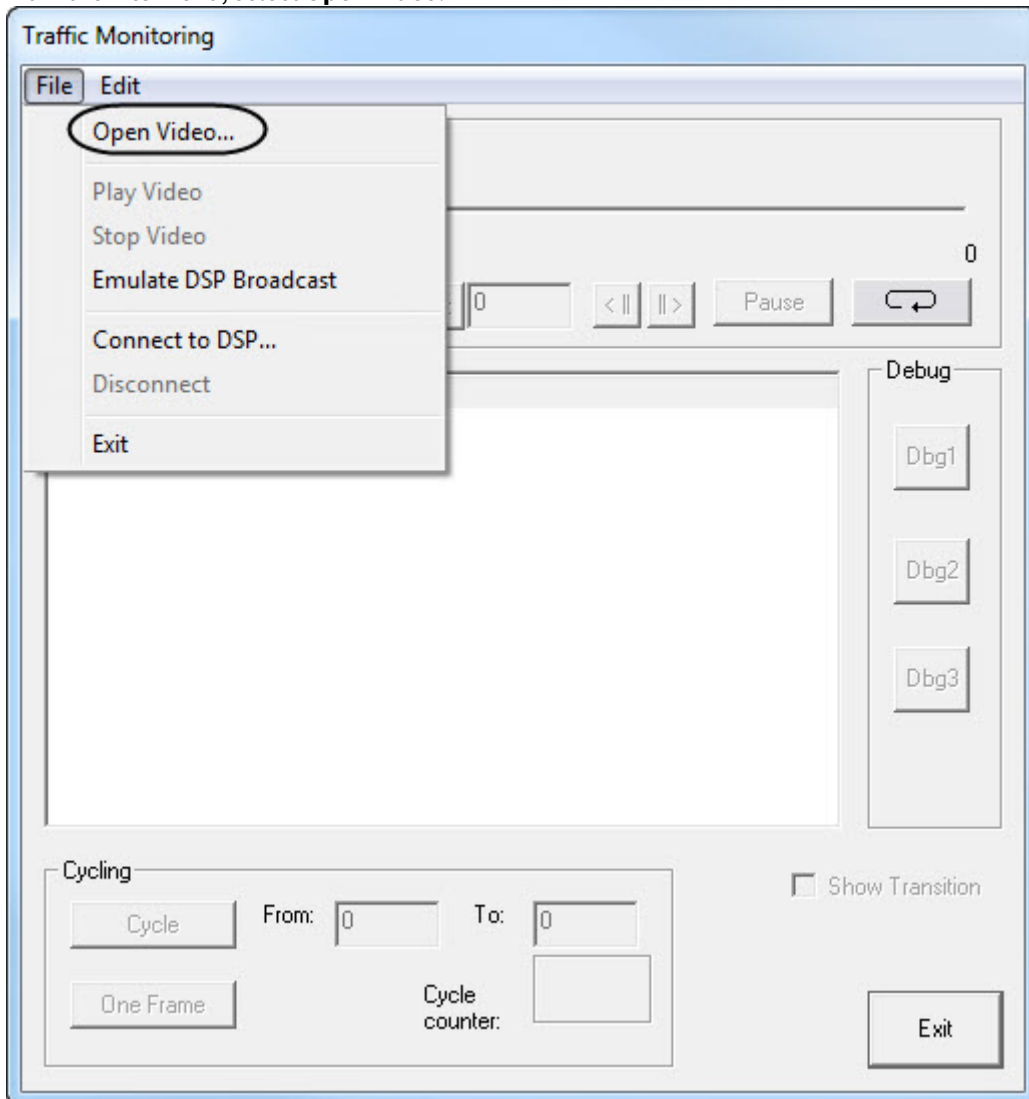

2. In the standard window for opening Windows files, select a video file and click the **Open** button.

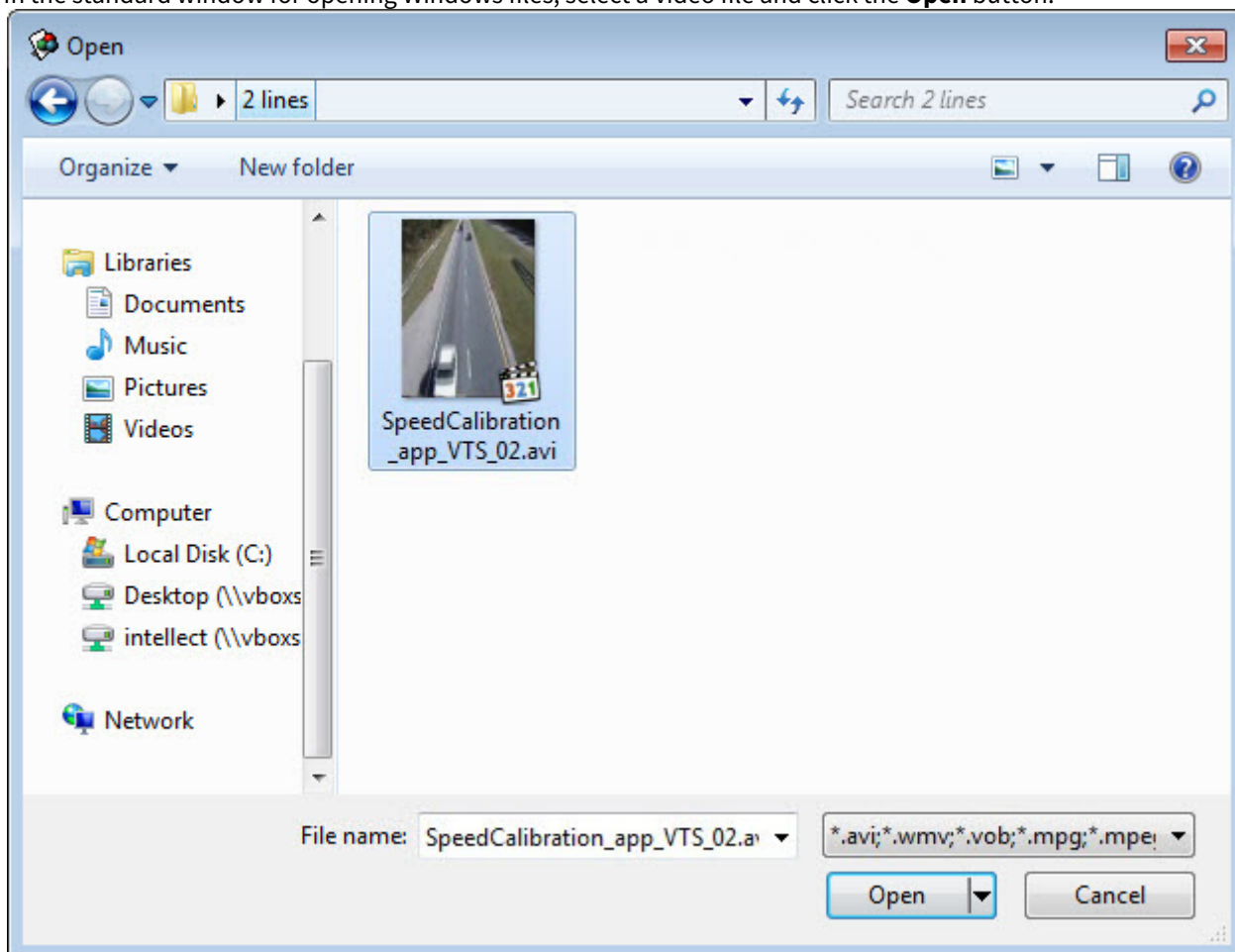

⚠ Attention!

The appropriate codec for the opened video file should be installed in the system. Otherwise, an error occurs when opening the video file.

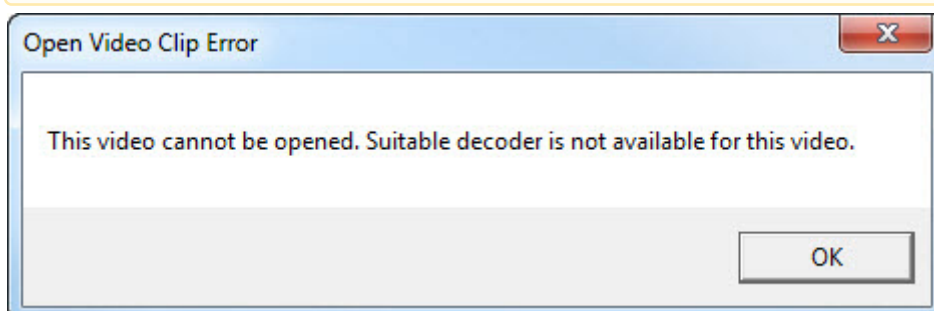

As a result, the **Area editor** window opens, in which the settings file for the **Intellivision vehicle detection** module is

created.



Opening the video file in the **TestAppTMD.exe** utility is completed.

6.7.4.3.2 Interface description of Area editor window

The settings file for the **Intellivision vehicle detection** module is created in the **Area editor** window.

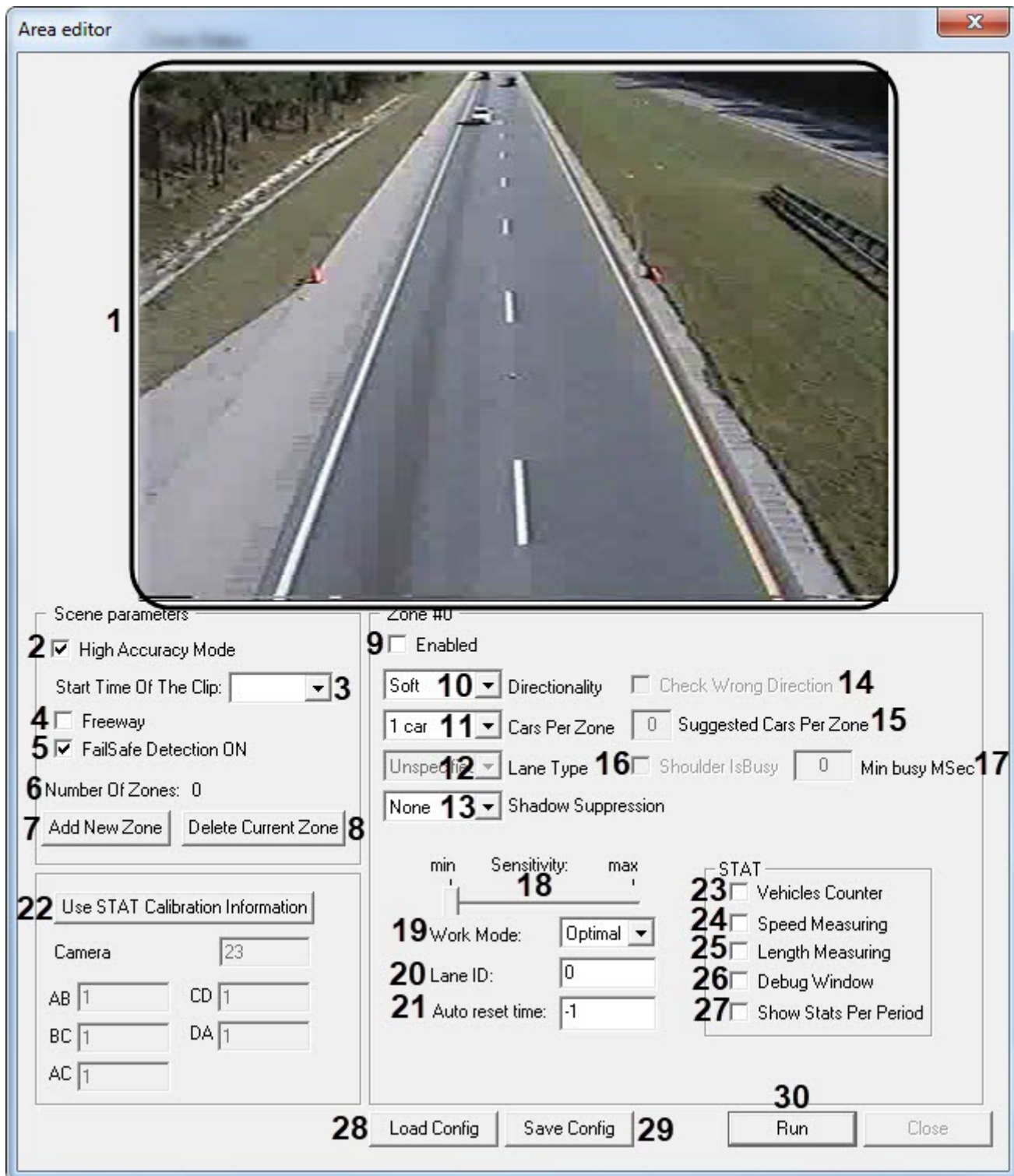

The description of the **Area editor** window interface elements is presented in the table below.

N u m b e r	Interface element	Description
1	Workspace	Displays the information about the areas on top of a video image

N u m b e r	Interface element	Description
2	High Accuracy Mode flag	Not used in this version
3	Start Time Of The Clip field	Not used in this version <i>Note. It specifies the start time that will be used as the base for sending the timestamps. The frame timestamp is calculated as the $TIME_STAMP = (START_TIME + FRAME_NUMBER * 1 / FPS)$, where FPS means "Frames per second", and FRAME_NUMBER is the zero frame index</i>
4	Freeway flag	Enables / disables the freeway mode. Should be activated for a freeway where the vehicles are moving fast and non-stop
5	FailSafe Detection ON flag	Enables / disables the video signal availability check
6	Number of Zones	Displays the number of zones in the workspace
7	Add New Zone button	Adds a new zone to the workspace
8	Delete Current Zone button	Deletes the current (highlighted in red marks) zone from the workspace
9	Enabled flag	Enables/disables the processing of the selected zone
10	Directionality drop-down list	Enables/disables the vehicle direction check <ul style="list-style-type: none"> • Hard - detection of vehicles will be limited to the cars that move in the right direction, or the cars that stopped in the zone • Soft - maintains a high level of detection of vehicles that are moving in the wrong direction, but slightly weakens the detection • Off - vehicle direction check is disabled
11	Cars Per Zone drop-down list	Allows specifying the number of vehicles that are "visually" in the zone, if you place them one after another. For detection of stopped cars usually a value of 1 is specified, and the zone of the corresponding size is automatically set, and the entire roadway is filled with these zones. As a result, it becomes possible to create wide, stretched zones that cover the whole or most of the lane compared to when you create several zones of the "single vehicle". <ul style="list-style-type: none"> • AutoDetect - automatic detection. • 1 Car - 1 vehicle. • 2 Cars - 2 vehicle. • 3 Cars - 3 vehicle. • 4 Cars - 4 vehicle.
12	Lane Type drop-down list	It is used to configure the type of detection zone (to configure the response of the algorithm depending on the expected behavior pattern). <ul style="list-style-type: none"> • Left turn - a significant amount of staying (waiting for the green traffic light) traffic is expected. • Right Turn - (North America specifics) - minimum vehicle stop time, etc. • Shoulder - not used in this version. <i>Note. The Shoulder parameter is used to configure "Roadside" type of detection zones (detection of vehicles that have stopped because of alleged accident)</i>

N u m b e r	Interface element	Description
13	Shadow Suppression drop-down list	Controls the shadow suppression algorithm <ul style="list-style-type: none"> • Soft - soft shadow suppression • Hard - hard shadow suppression • Off - disables the shadow suppression algorithm
14	Check Wrong Direction flag	Enables/disables the visualization of cases when the vehicle moves in a direction totally opposite to the originally set direction (orange color)
15	Suggested Cars Per Zone field	Specifies the estimated number of vehicles that are "visually" placed in the zone. It is directly associated with the Cars Per Zone parameter.
16	Shoulder IsBusy flag	Not used in this version <i>Note. Enables/disables the display of information and events based on whether the lane of the "Roadside" type is occupied for more than a certain number of seconds. This type of detection zone is suggested to be installed in the curb area if the analytics are required to detect the cases of roadside occupancy at the installation site of the detection zone by a car, presumably in an emergency.</i>
17	Min Busy MSec field	Not used in this version <i>Note. It is directly associated with the Shoulder IsBusy parameter, and is used to set a time threshold (in seconds) to start sending messages.</i>
18	Sensitivity slider	Indicates the sensitivity level of the vehicle detection in the selected area.
19	Work Mode drop-down list	Indicates the operation mode of vehicle detection <ul style="list-style-type: none"> • Optimal (default) - provides the most balanced and accurate vehicle detection • MinFD - provides a good level of vehicle detection, with less false triggerings • MaxTD - provides the maximum level of vehicle detection, but sometimes it can produce additional false triggerings
20	Lane ID field	Indicates the identifier of the lane associated with the selected zone. This information is used by the Intellivision vehicle detection module for better detection accuracy.
21	Auto reset time field	Indicates the time in minutes used to reset the zone if the zone is in the busy state longer than the specified time (default = 0, which means disabled)
22	Use STAT Calibration Information button	Displays/hides the rectangle within which the statistics are calculated
23	Vehicle Counter flag	Enables/disables the counting of the number of vehicles
24	Speed Measuring flag	Enables/disables the measuring of the vehicle speed
25	Length Measuring flag	Enables/disables the measuring of the vehicle length
26	Debug Window flag	Enables/disables the debugging mode
27	Show Stats per Period flag	Enables/disables the displaying of the statistics once in a time period
28	Load Config button	Loads a settings file in .json format

N u m b e r	Interface element	Description
29	Save Config button	Saves the current settings to the settings file in .json format, which then should be specified when configuring the Intellivision vehicle detection object (for details, see Setting up the IntelliVision vehicle detection parameters).
30	Run button	It is used to return to the Traffic Monitor window and start monitoring

6.7.4.3.3 Guidelines for creating and configuring the zones in Area editor window

6.7.4.3.3.1 General information about creating the zones in Area editor window

To create a new zone, click the **Add New Zone** button. A square with red corner dots will be displayed in the workspace.

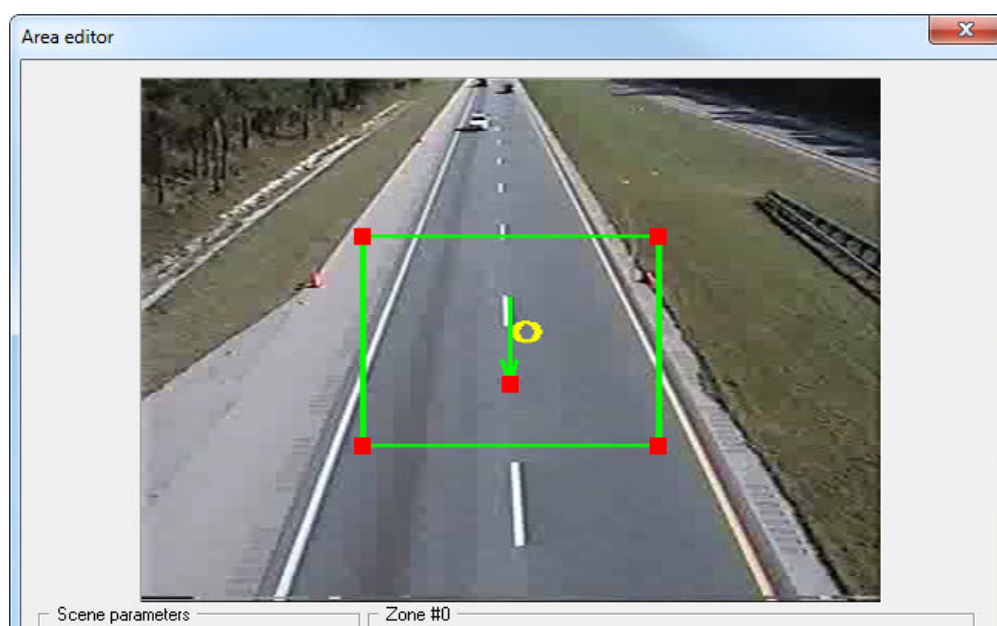

To select a zone in the workspace, left-click on the corresponding zone. The currently selected area is highlighted with red corner dots.

To move a zone, left-click inside the rectangle and without releasing the button, move it to the correct position of the zone on the road.

To change the size of a zone, left-click on the red dot of the rectangle and without releasing the button, indicate the correct position of the zone on the road.

6.7.4.3.3.2 Examples of correct and incorrect zone configuration

Example №1

If the lane has a width for more than one car horizontally, it is preferable to divide it into several zones so that each zone covers only one potential car.

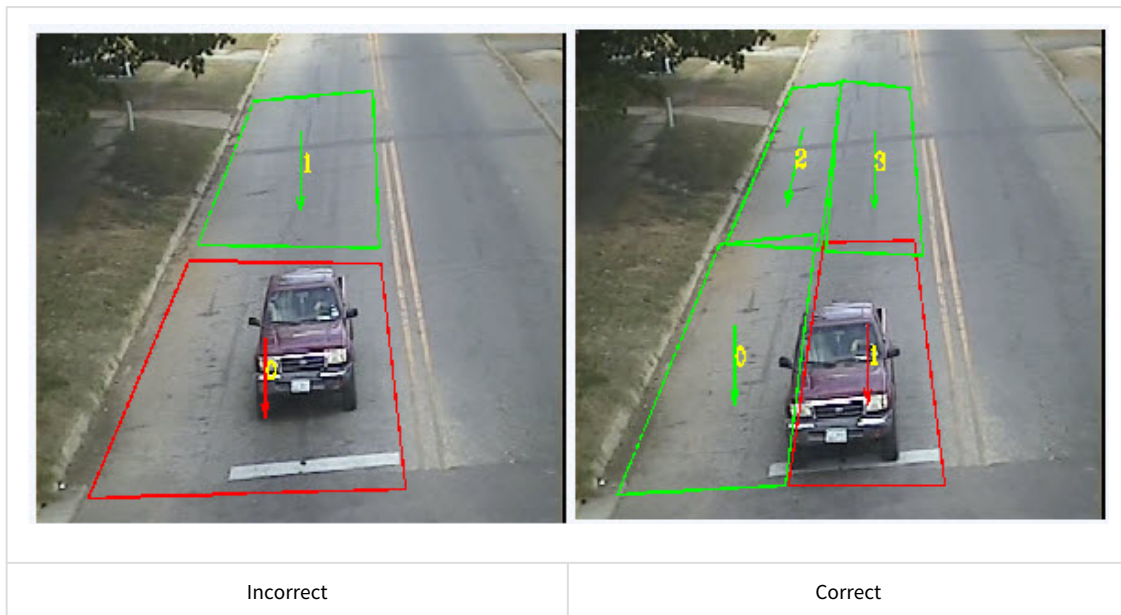

Example №2

If you configure several lanes which are placed at an angle, it is recommended to use several zones for several lanes instead of one zone.

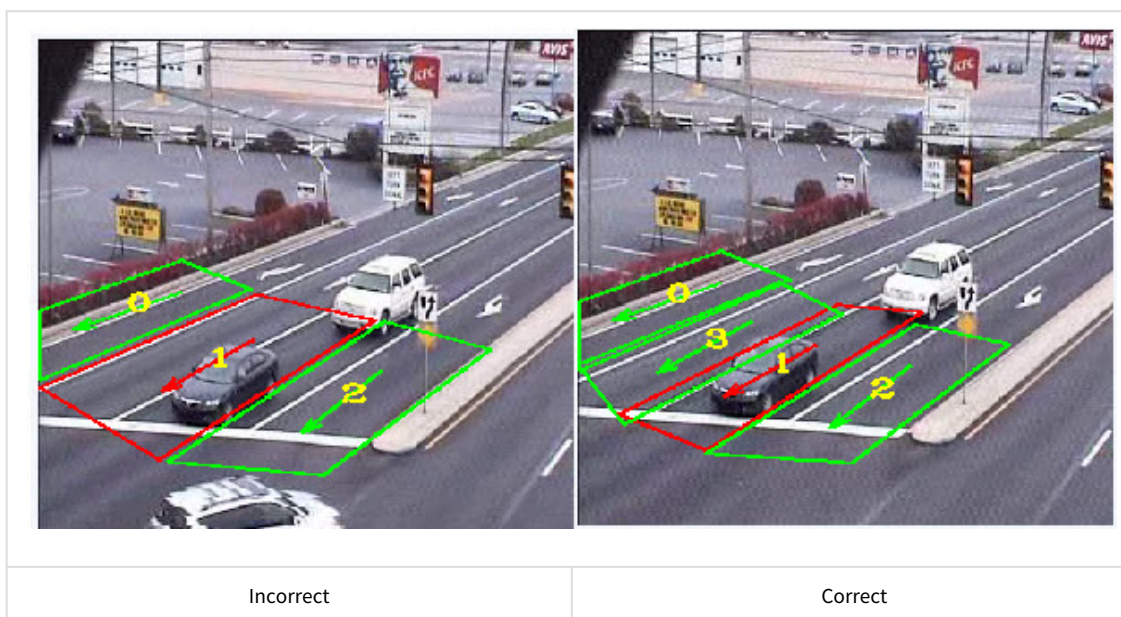

Example №3

The input video for the **Intellivision vehicle detection** module has a resolution of 360x240. An example of such a video is shown in the figure below. The Zone №1 in the left image has a non-identical configuration (the width is approximately equal to the height), so it may not work correctly with the automatic zones division approach. To increase the reliability of the automatic division approach, it is recommended to use at least one horizontal edge for the zone (vertical or lower), as was done in the configuration image on the right. It is recommended to use this approach for all zones whose width is approximately equal to the height.



Example №4

If one of the zones is too wide, in this case it is zone №0, then its sensitivity is reduced due to the excess area.

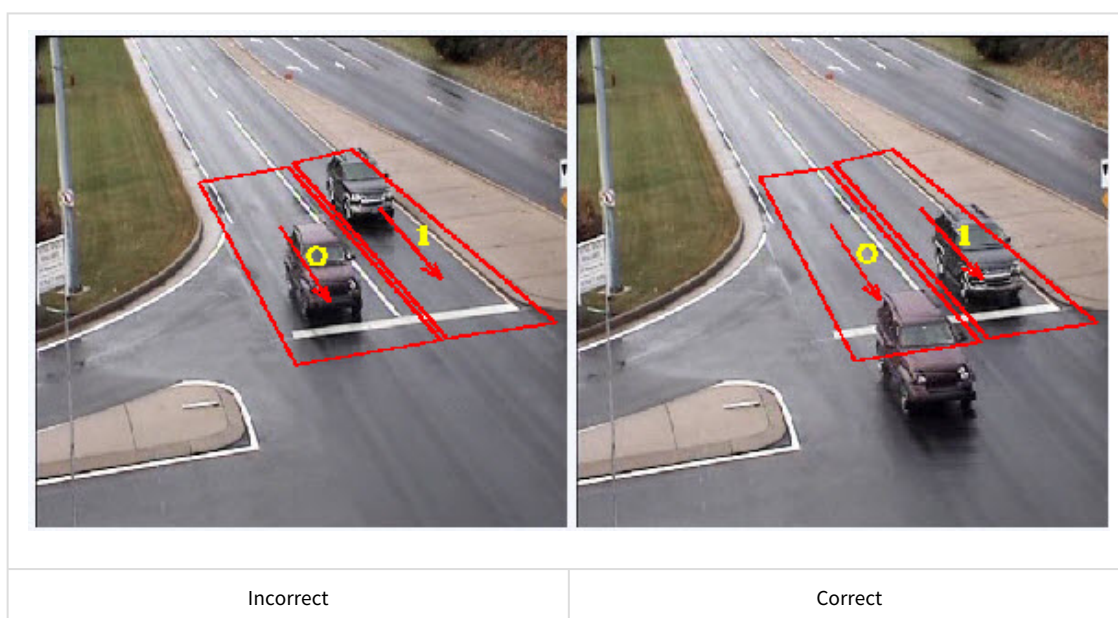

Example №5

In case of using the detection of stopped vehicles, the zones from №2 to №6 and from №9 to №13 in the images below proved themselves to be good, these zones provide high detection accuracy, except the existing problems with the zones configuration for the image on the left:

- the first row of zones at the top overlap with the road markings - it is recommended to avoid this, since it can potentially lead to an increase in false triggerings. This problem is resolved in the image on the right.
- the first two rows of zones at the top, which are highlighted in yellow, have an area and size smaller than necessary for the high detection accuracy. All areas highlighted in green are of the correct size.

For high detection accuracy, the zone should meet the following requirements:

- size of the zone (the zone area in pixels) should be $\geq 1\%$ of the frame area. The zones which size is $\geq 1.5\%$ of the input frame area, provide high detection accuracy.

Note

- The zones highlighted in yellow have approximate size of 0.5 - 0.7% of the frame area, which is below the requirements.

- If in actual practice it is not possible to change the size of the zone, then it is possible to use such small zones, but the detection accuracy will be reduced.

- the width and height of the zone should be $\geq 10\%$ and 8% of the frame size, respectively. The recommended width and height of the zone is 12% and higher.

Note

Overlapping of the zones is allowed. For higher accuracy, in case of the stopped vehicle detection, it is recommended to use the zones configuration in which one zone overlaps another by up to 50% (along the lane).

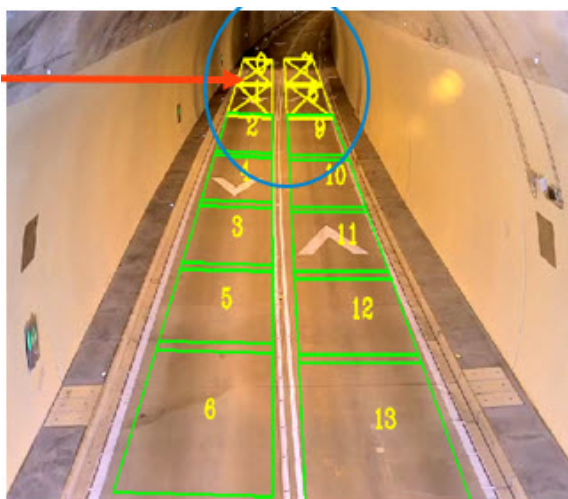

Good location of the detection zones

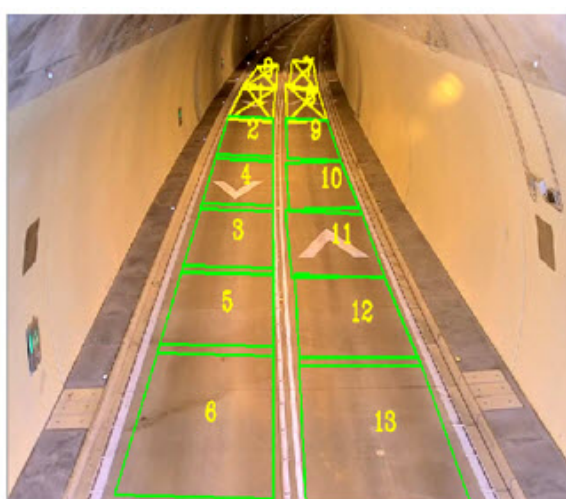

Best location of the detection zones

6.8 Appendix 8. Auto Intellect. REST API

6.8.1 UrlServer

The **UrlServer** corresponds to the **Vehicle Type Recognition Module** software module.

Note

By default, the following http-address is used to interact with **UrlServer**:

<http://127.0.0.1:8091/GetAutoInfo>

To change this http-address, it is necessary to change the value of the AutoInfo.Url registry key (for details, see [Registry keys reference guide](#), for more information about working with the registry, see [Working with Windows OS registry](#)).

6.8.1.1 Initializing UrlServer

6.8.1.1.1 General request format:

POST <http://IP-address:port/UpdateServer>

6.8.1.1.2 Request parameters:

Parameter	Required	Parameter description
device	Yes	The device on which the neural network is running: CPU or GPU
file	Yes	Full path to the trained neural network file
sensitivity	Yes	Recognition sensitivity
key	Yes	An arbitrary unique key. It is necessary to prevent reloading of the neural network file if several LPR channels use the same neural network file and device
lprid	Yes	Identifier of the LPR channel in <i>Auto-Intellect</i>

6.8.1.1.3 Request example:

POST <http://127.0.0.1:8091/UpdateServer>

```
{
  "device": "CPU",
  "file": "C:\Videos\dpe_001_openvino.ann",
  "sensitivity": 65,
  "key": "C:\Videos\dpe_001_openvino.annCPU",
  "lprid": "1"
}
```

6.8.1.2 Removing the UrlServer instance

6.8.1.2.1 General request format:

POST <http://IP-address:port/DeleteServer>

 **Note**

This request lowers the counter of Lpr channels with the same key (neural network file and device). When the counter becomes = 0, the neural network will be unloaded.

6.8.1.2.2 Request parameters:

Parameter	Required	Parameter description
key	Yes	An arbitrary unique key. It is necessary to prevent reloading of the neural network file if several LPR channels use the same neural network file and device
lprid	Yes	Identifier of the LPR channel in <i>Auto-Intellect</i>

6.8.1.2.3 Request example:

POST <http://127.0.0.1:8091/DeleteServer>

```
{
  "key": "C:\Videos\dpe_001_openvino.annCPU",
}
```

```
"lprid": "1"
}
```

6.8.1.3 Unloading UrlServer

6.8.1.3.1 General request format:

GET http://IP-address:port/Shutdown

Note

This request unloads the UrlServer. If this request is sent during the UrlServer operation, then the UrmLpr.run will restart the UrlServer. The request is designed to shut down the UrlServer process when the *Intellect* software shuts down.

6.8.1.3.2 Request example:

GET http://127.0.0.1:8091/Shutdown

6.8.1.4 UrlServer frame recognition

6.8.1.4.1 General request format:

POST http://IP-address:port/GetAutoInfo

6.8.1.4.2 Request parameters:

Parameter	Required	Parameter description
key	Yes	An arbitrary unique key. It is necessary to prevent reloading of the neural network file if several LPR channels use the same neural network file and device
lprid	Yes	Identifier of the LPR channel in <i>Auto-Intellect</i>
left	Yes	The coordinates of the start of the license plate on the left
top	Yes	The coordinates of the beginning of the license plate on top
width	Yes	Number plate width
height	Yes	Number plate height
image	Yes	Base64 vehicle image

6.8.1.4.3 Request example:

POST http://127.0.0.1:8091/GetAutoInfo

```
{
  "key": "C:\\dpe_001_openvino.annCPU",
  "lprid": "1",
  "features": [
    {
      "left": 1151,
      "top": -2,
      "width": 107,
      "height": 23,
      "image": "4AAQSkZJRgABAQEAYABgAAD/"
    }
  ]
}
```

okMno2D+dYettjKg9e340AR2SeVp0jHrio900LpZApOxGk49uP61YPyaWfeoLHKJc0HAKwFcFujH8qALFtC3LLkZ71a+znH3TVmzi226d+KsgdsU
AZi253dKtx2xI6Va2LnpTl0GoAq/
ZCDmknc9K0xgjpRgeLAGX9mx1FH2f6VffBbAFR4+LAFT7MaPIIq5ij8KAKfkUvkVaowKAKvkCLMAqzxikwKAKvk0v2b6VZwKMeLAFb7MKd5AqY
jmgDmgCLyRUi2wPNS44pd3GKAK5t1JNM+yj1q1SHg0AV/s4FMAeVdVN4NI8JHOKAKXkCk+zmrGKUUAZt5E0MQnXrGwb9aqamwj1ISqOHxJ/30M/
1rauY/
MtpEx95cVh3zGXT7WxQ21o20P7pwP0FAG0hcXqT3HGKk2TmVbX6k1W06RprN0p4xVvkqBweFrQBF5bYyF60mw9hVjJV0HIHoDwah00vBoAjK884p
pUZ4qQ7jwcAUuY8fdNAHYk7z2P0prAY6/hUoKDO9M/
jUTqCcgECgChbTuAKerIFIYnntimHBxQAVamHAPb8aexUcAZpp65AoATIzyKCyk8DijOrz1o4xQA5eD0pJG9TQDjJpJzJ65oAI84J3bftin4JGS
wZqEUqPmRD6ZGaQoCcsVH4UARtjPzAg1GzH0qU7AeQPypCVA4P4EUARDnsfyo04duKmWRVHUfGKa7qaAIAC1GBv4NSebjjccUeaeuQ0LAAFJ6DNV
b35YgG45qzvT0x9DVUDHKBKDNafEHmMlyjHKNkfnXL6mTJKrHOXk2gY9BXS2DSFbmFFQqcnLEjtVWEG02dW5KMSBQBMXny6dGD1JqK3EYs7ot98tG
n6E1LqB5iiUkZz2pLsY/sbZGxe5A0f9lf/
AK4oA3LfiAVZRRfjU7cnYRVtSMYPPTQAPiZikHJ4qQ+WxBVNv0pygAdKABRt70pzjSEZFC9MUAMI70nHpUfPMK0AnpCKeFJOKGj2jI0aAIqQ040
LABo1lXkpaADFAoouASLHFbKAHZpKBSGcb1NIpaKAJO6GMVNjIxioRxcg+1SBsnFAFORcOabirFzHzkdCKq0ASHayEGsSSMnT7iHHEM+7n0Ygtcnk
Yqmyk3N3D2kt8jPqCp6UAQAaHJmJk9DW15ZK5KZFcpcxvImQ4wwzXR7yRy3PvQA0gEkYpmsAVYAKVmcTkp+QpNpc8byf9w0AMLDFMYB3oe0ZW/
1YA9SKPm/6ZigDt2Iz0qI9cZpvmLnlqN6/3qAEIz2pn3G96cZrt0DzVY7/AK0AWWn3D503H2wKbnioUZh0BNP8w9wBQAtJmm+Z/
kUm8Z4DGgB26lWdZuQIPJ49jTtyEcsMfWgCTf2pGJxzUYkUYC9PWLd0HRs0AIW56Um4nrTGkUc5/WmedH0Lj6UAS59qaTweKaZowQwFb9Mn/
CmNcBz1H4ZoAU0h0emKN4/utVa8ufItJZRGeF9aACXULeBijtlv9k9KqzXkFyQVLUY9a4ia5kklLM5yfekE0g0d5/
OgDtrSaK2md2LUhVSoRNEZpkVs7uQPxrLFu5B1ap4rtlCskfmHvQBa1HIuEX3qaxPmQW8UUW6WSWQ8e0Koz3P2i6D47Vt6EscT5pcY00FHkY90r
UAao0rUkhMz2SrEvBbzRn8qZhlwCMV6Bqxj/
s00MeUQDk46muFmQhjjpQAkeMGN4PpSQuUBNwvtSE8oxNAFfae6n8qMYNWWusLgrJfV307n+tACE+tNpV+9yKsYik68H3oAqk4oDdc101suCwaqp
G1uvvegBjH5qQHPSlcc00cUAlmL470nWlxQAFs1g0CgBe2aMg0h9KQIFsG4I75oMoHQcK2H0pPLoAeJu0i0CVSeRTNh7UuKAJfMwPFYZqtPanoC
aALEUgJ+lZ50M1cZjhaaov1NAAGGagYJqdpJ2LFD+INPH3sVV1LP2YSD0Y3DD86AMl82+qoDu4bacjFX73U/
LkAVsY90ap62M3cky9HPMA+x5rEmLI4PWgDpf+EmlcGX/vkVE/
iSZuBjJ6Vyx1J70nm0AdGFEE+75nyPc1pw3PnxLlChdXEmQnjvXS2AnFlHnjigD0ZwMchaj+UcD8s1cftLhUDtGj2JYc0iqsY05SV9qAK2xMc9fS
oyIgeN34GrskcJXcE2+2c1SZQDQA5V3dHIpTH75pinF030AJ5PNOEe0jEfQ0B8mndRQAxo1PXJ/E0n2WJuQv1an0h/
CgBnkxA4BB+hpGiiZkzn0KeJHAWGppUZ5NADfJiP/ACyQj6UCNB91EX8KXHGQX/
OK5xznFAC4G0KbuI7mnA8UHAPWgBpY1UvoDd2ckAbbvHX3q5tU9KaQR2BFAHm2p6JqmnszSwzSRj/lpCNw/
HHSvzGHb4+or1m4z9jzmj7prjLu2hXIKiU57jg0Ac2JTiyZcuATWtL4di8oyW8zKcfdcZ/
ws2TS7y1CtJH8p7qcIG3GmSe0xx+Vb1uoSKyK7lKwDLSQeee1YVsr0xG0/
dPWuh0u4gWCXu7oFreP93LtgSpHHP4UAdhoni+1Kw80Xr25b7oLJIP1zUN/
wCG9Z0x00IuEH8dud36dR+Vd5ousaPc2Gbc6jYKudp7fhXM6j8VfDgkXmgu9RSaZePjtl3E+x5oA5RZBkggggjQC0LSoc/
4Vi618R5NbumlsNLKxdE3Jz8KyDqXi08uHLOTYewG39cGgDsJncfeKKB/
eYCIa2f0biED3kArgm0vZG82S2L1MLzn+LMPK5E+swc00NgfNAHpZSHH+uhP0LU/wBajKx/89Ix/
wACFecwnSActa88fr5RBz+Yq8g8Ks6k6tIzjoXk/
wAKA02cFBGHP0NVznPSQvRfblxaXENw03ykfrmpZLy6i5m0u72DkyxJvUfU0ASnrTTUUEqWfYpklP0IxVaa28WXH+ztIL2/aveLZH50AaKoxHQ/
LTXmhiTmk8S/VxWG/hTxbep/pVtej/
t2Jx+TCpoPh9rBIz31BCofltsfzJoAdceJNLh0BM8jDtGhNEfiGzcBgceZBqK68LtayeXejqwbGcCF0f/
HaZ4V0y54D6iz+spUf0oAvQ+JfD0Lv/
aL9LajHyMsL0pUvBrTg1fwhdWbyQeJov0GCFdWUH2wvzVXTfBGkQ3kcmp6daXdt3WwDg36Gu0hsPA9rZSW1vpNnCWxADMSM/
UmgDm12SDde4dT0I70GNh1FSSaOqn/RJbK2XsYr0D+amqFxFjQvM4VLvSbkY5Ww9Ct+i80AWxHkUmw+lZSeLrNH2XAcFwSrbl/
Ota11C2v499vPAw/wBqTbQAmwn+HNG1h0U1K7Moz9o05f8AeUwP6VVe7YHH2vRyP+wgB/7LQBKYRIMkcyjVWwSfL5uUq3K44vtJz6C+B/
wDZahnuigW13o4HqdQA/wDZaIAIH3kdZdxl7aRcdVNS+deQSMo6MT6fbx/8TVSW7g3FL7V9ItIj1dLsSsfouB/
QgdNvkawztj5eCbdec+nFYN1EzIGHaurkntL9liZIXtok2I7Jjd71n2cMX27ypon4B/
iu8frQBy0cMkz7EXJ9Rwnb6DI7AzzbF9EHNdytnaxqFw2AGP4Vq0SziJ4jdB/u0AYtpptlb/cjy396Q5NX8gcACpfsqZ+YOR/u/wD16d9mA6Iw/
CgDu3TdjJI/
3qgeIj+LA7YNSSFRJ8y8GkkSJrW2PoKAKrD5sZyFwMfcJqbbzmjYDQBUZSDkdaRmZjzjP8AsrirLCMZ5Bp0qFun+NAEeacN3rTQFLat+lT4G3jN
AEWSKcDmjYKAAAtADWyoLioVJP4DNP00imZ79qAEJCgHk/Uc07zAy8x/kaDJlccNF9+c/
zpEjZj8oz7ZxQAQIK9KPKDH5mcfUGnbdmQ6liP7pprvLQTyfTOaAGKKn07PsBTC+7s10ySvAJ+ggPvz8tAEVwC1rKCCDtNciSTJgmuykJKugctuG
Oa42UFLhgfWgC4gJhXntUN3j7Aik50cYNTQfcxV04ywx70AV7WMk8jFTpBqljctcaVfG3d+HjZdyP9R3q1bLEFG4Et7VfDrxhfwNAGVFda2kokfS
fDks3XzTYIp/Pbmkkk1eRy7aD4Y3H+M2KE/nsrdQKf4QKChI4oAwlm8QovwywG4x2A0qM/8AstTDVfE0eQJdDQ/
7GmIP6VpNb038WPpTDYUSCZD+Q/woAz/7Z8UnpF2a/wDX0zRakGp+K2GB4ikiHdY4sflq4bUd4m+oxSizfrt2/
U4oAY3pia4+94u1WP2jlyf+zUimv7/jLXT9Ll/wD4qtU2rDqVH0bNCwT242gfjQbnLBrB+U+LNfi/6+5B/wCzU+K2vZARJr+uvjqHvZMH/
wAerS8u4zyy49hQySEYysf90UAZE3h+wLJaeSarV7zNk/zqnBp80c5iS1vJYPacY/Vq2J/
IhIMqTDPGcGok1CwQj4y9FP+FAEH9hWmpBk0e4z73C/
41KPD+kEYfSSPdpQ39anj1SwmeNF+1Bn6bhgfybpi7t7Z2SWKRio3ZB7UARjStLhH7u2EY9BSGysW/
5ZLj0JzTH1Kx+b9zCAHLu1SQXEFz00ccQUgZ60AM/s/Tlxmyt3PX7vP8AKk/s7TWOdpLv+X/
1qG1a2ik2SwzEnln5u9A1uxYKRauCzFfvc5FAD/7H0vH/IngH/bmf4VcdLs/MIXTYUUDCFFXRc5iv498IdRnozciRhtJCP1J/
FqAMr+zbZlWY147YqtFpcT3gCR0F9AvWtk2k5PG386kS0kzk4XH93NAFZvDloib5dHiIP8AEwXP+NRHSNKHXtof++R/hWn9Lc9ZD9WJ/
nTWhnj5Dhh70AZ40bSW6adF/3z/wDwPw0Pscif2dF/3z/9atSEtnnpVnco6HmgDn5PDmj9TpNufqo/
wqP+y9MgceVYRR46bRW3KceahjtVpMxmgCp9pSCPYidvXFZhlg/
eSd2eua6W80cSx5iKbg05Arnbmykh0HUGcGdctLoyRkD5wPrUklwzNtDcehrL0qR1BjZsDNabx+mSKAIWlg5yaZ55HG406RF9c/jUXlr/
ALI+poA7N1Y9WqPbnhufep20/
JLAE2K1n2n64oAYcLxxSED+9QCAMUANZejd0MVKaaRzQBXEEDT8ECn0cY6UAVyx3c9KeDQ6huLM+cfwUA04z2pp59MU0k55uLWUI2WQ0PQ
0AAUt0I/Om4c0BvIx2Wn+YH6Rqv0Apo3YP3h7igBW2k5cEZqE7Qflw9xUq06fwZP8AfI5/okZLJySM/
WgCpCB6Z9MUuFcZkBW0HwHGJ559qTL9hgfwGA0wPlY9gznrmuPv02ahKP9quv6+v41yOsSY1WzCYwaAJYjxj2qB15yafE2UBpWGR0oAngjGM1bj
Qbc8VUg0QKuo/
BwpX60ACNhsBuKg2bvmBp6kjrQBLkZp4KnrUW4UZ96AJW2FetSY3Kbjixqzgm1mjfuXzQaajtNOCgeLm80e1L5goAeRTCozS+YMVE06g9R+dAFBU
NO+3RIiy+wVYnbnms8eH8Nn7Y3DbuIh/jWz56eoz9aPNHufokAMLPDqq8bfbJPkcsPL9e3WrvZpMV1IrPNIuF2/L3q75h67T+VIZFYj6igDL/
4R2DcB9qn27NLpTndhtboTJczsQoUjhwa0R0vQkUM2PmGSPYZoZabvW/b3U8sjPKpkYMDpHUVAFDnNuz9ouQd+/
hg0a11awT7scn4qrU00jx6xCPY0AQWGM06cXMM0rB23bXatMS5PashpSeVJH40qysDy3agDVMvPY0ok9MVkeYx6sa1S4C8Z/
WgDTElDPkKqCCK5G9T9BmncT/AGW/75NADkkwNvpTjIagVGkuNoJXPqK0orRV+8dxoAhhjAq/NnFXUgSL/
VqBSgBRwKeh55oAG44PqsLpbSE77eNiEU4c1dbBqPjsaAMSSx+z3HmRKAh7Yq1k+XjIH4VfmTDAwA5xwQGHQJn3zQA8HaPvCmecF42k/h/

9emNnOBxSbW7yYoA65iqjc3AppmjYZj3D6t/
9apWURjBffn0YjFRd8kHH1oAY3PNNPTN04pDQBGsfWmMzDvnmSKSOKr8g8k0ASiT1NSZGDiqrc8ilV2AoAnzRk1FuPtShjQAScoyKefemMeKAF6L
w0AxZceAqLj20f51GkhVvvbaduTcwb94fQnFAAN5PJyPY0hjB0WAXjvQWQn/
AFagfnTGbaefJ394oAaWHTp70iUwIrn3pGkdup0PQnNG6GBXdnIyRx6VxmunZr0nXBwa7LIAcy5rLVE0nXmt4LxNjRYAbnkUAR25HlKVYUzBqnb
k7Rmrv8ADQAqf3mz3zWnAq5JaIOBzhs4/Q1kIxw5B6V0VrdzpaUjnkRSOQpxQApntzCFGnQQt/eiLc/
mTVfygXznipDnPPVvSouTmgBv2f0Yinrak9XNSqKlFAEK2qA87qUxZbCtTtHpU2aUAF+PSgCm1vnoaT7Mu0Sfzq2+CfL4pFTJ5oAZHbQnsfzqX7JD
/cFSKm2n0ARCGNfuoo/CpAA0Nq/LRRQAYHOtKA9B+VLSfSgA2IeqL+VAVR2xRnmLoAKyTtCQqA1D0NyD1MzyEEYwaAKe3HGRSBSTgZJ9qV/
v8dKv2S+Zhiq0AZXnByD70zYD0NXbpVEx45qvs46UAX9NaQggrx61pM5RVwhP0rEspvLmx61uBtwG0LAEF2MGKZR04NXUbc0e1Quu6F1x2pLcL
osd6ALA5qTAXmox0pcnFAD1wxikQe9NpeaAGvKUBaVYg8ZARL2oJHqsV544rWycYrLvUaUASMZoAYUVvL3fieKY0cKnBnQe2Kkju87QCMeuKgY4b
GDQB1rll0CB+dMPPF8MVPK+RgZUdwTn+lQ/
U8e9ADWbFIDkdqjkw0hzQjZH40ASnyKrOnpU5PGKbQBVJI7U3easNtwfWoTsPwgBMu0Spx609W3GoDjdgU4buoJGKAJm68UHGRSImkHG5y0vAqIy
44IoAa7N0LcD2oXbjnIpgZuBn2qTlJrGAPegAwpbB5FLIE+HHbUL888D2FN3Z6g0AOK9yPCimMQDn06kMnM04FRlHQBITknAAqhQRD2Eo2gdK
sL59KpXzf6i2AeAMSdG4f+SPLrMifLH2q+MmPPH40ARSKrhvQ1t2EgkQVhyHchqzplwQAM9DigtDoh9KeigdRUCeU9Km/
EUALGULIWAAppbJzQA+lv8HPTAwppP0QAaJepynb0qNXBHWkBweaAJd9Kp3sFB5NRbSMY+vNAFLZCVPUUwNg81D5vH3qaZMigCx5opN+eLvt/
PWjzPegCxpucd6q+Zz1oMg9aALXmCqtXaxTnP3T7U0y4PwK84UAVpdLkzLJUB2NQtpzjKnGP7rVf8454NAn57UAY7Q3QY7opT7LTR+86eW/
8A3ya2vThPTMT3oAYooWaQfLcc+lb8YxyxfqmLhuJYp3nj1oAtbsURKIaQfaFHemNc8g0AaJkWmGQ54rON1iLW6HqKANATNnpUnmcc1m/
acU5LoE4zQBo7xVDUeTEw9cGniZ3qC/YfZUYHPzUAQZ2+360FgaYGBXPOfrQCR3FAHXF/
nzj8xmkaZscNg+i8U1xxjB+0ajYrt+8SaAGSbi3zcf8CoR1A0c59qYx70zckAJy2RnOKZu96b2pDQAjDPQ1AY2zyr+dTEjpTePwGbnHvTvMxwM01
gBLiRgU1SPHbzQApLAHVtC+epNI6k9Kh55zQBYXbw2adLIMYVlqqucYzSEKN3PtQA9246iojMQetNfL8E4/CmFAoyMEe4PNAEnnL/
FTGdSOKhds8bVH0phJxQA8vg8A/
hVa7k3Qsv0oZ2x1qtNnYQe9AGWn+vKYrSkBFoVAz681iStEVdFieBwjBIJovXigBS+cgVfBz+VPj3p9vBJcym0Mcmjmq08bRTjPXPNAHT210vlg5
xU4vk6A1yUu2AwGIqMxV1IxEI3fU0AuedRRW5wfrUT6kucCuY/08nkKPPw+NB+3Hj5W/A0AdJ/aAPeKn/
jqa5pl1DuVAHPiP8AJTbdSQvYpzb6ADQNR70HUR61sATENGaXeT3oA3f7RhrQdQz3rB8w5607zD60Abn28etIb70IrE83PGaPM9zQBtfbz60g1
D3rG8z3NHme9AGwdr96ad96yPMhrQXG0tAgv/aHuKT7f71k7x60F6ANcX/
HwkN9z1rK3j+9RvH94UAav240v249jWVvz0Nj5nvQBqG90euaa16SODWcGJHwjn1oAvfbd3o+2npis7d6mlyP71AGkt2D3pGvV9RS6Foa63qP2Vz
LzjBj0DXa33wfsre3a4g1C8JvcsHk/4UAcMb5T3/WgX2DwabcabpEDmN2vGI/2h/
hVX7BpDn5ZLpFqQf6UAasV0WxyKlNmL2u3PQ5rmZ7SJJ9nmkG0jZ5qxDCyTfSfYU0Ab8fza7GGRyRuv1Fatn9nbw9C+1RN0Y45rNbhioKA0ocq
p4dX+gqzJq2VsqQeHfV5F64oArSyoBj8agBAXNHwjB+TQFSDjFAE3CjzM9Kr04cDIOaKLU3e05xTCCnmkODQA/cPwK+lR/
xUtADi3GKjBfKRzTWU460AJkD1x7DNNfKcgsD60wg7+9LJLV+ZHB+mKAIY24jec3rTWF5cH0B2ApRtIjL7T2BpHYuAS+4+wAoAjZLI+UfnULH1B/
LtskHqfzq0Q5P3jn3NAELn1qrcSYU1PJmqtWuUIoA56+k+c1oavPviAz7Vm3q/
OataN6UAbFnP9mvd5IAZjmq+qXILuHK7CZ4xT2UbyD9ao3AG7GKAI+SVN0iKksR0psWN4J6VzaGxf7zybj6MBQA9Jzjrs+djPNQm2gU4Vzj/
aanC3t8YmH+p61ACibx8np61VJ3En0qc2sGePMI92NL5cAGAX/75NAEHmyf3gvvjfKekoP/AakXxDje3/
heChLY+8x+iBgMzj1ng7bBSrvz80x/BB/jS+ZDn7zn/gJoMkPcuKAHLrj/j6k/79D/Go2st0T/wH/69L5tv6SH6CniS1xjE2fcf/WoAg/fd/
lr+lGZf+e36VNVgzjEn5U7MX92Q0AQZk/56E/hS750zskZtsc+bn2jJ/pRutfsY/8AAC6UAV98veR/wA6MuePMkH/
AAKrGYD91JPxpKkH8DGcDYE8kn/AH1QE/6aS/8AFVwBsP8Ayyk/OnbR2Hy/jQBW8v1eT/vqnCIer/8AFVT4Y9LdvxNKFz/Ame1AE01F7t/
31ShV/2j/wAcqU+Yotr+tg58/wDHoPzoAavlgfCp4tUsfL5GI1qaKkV+lon4vj+tbFho1/ckeVZW00+
+7Uf+zUAM0XV4dB1Nbu4tp5EGCpjXnd1qPw0i50yWK2ivEuJEx88WACfxrmpdGvLaPasFsm8Llvgr+rGq50yQn95aBR3K3Ib+tAH0z3PnuX3Ek+
tVTNPFdehZAFfLjB3kFU7jTFHKRkemCKA0c20ccVYRI41D7Dn61oNbyRjBRM9v8AIqtIMDDDB78UAaFhfObdYQo2Ls1bKkn0BWLbMAq4J+96Vqb
vc0Adv94/
epH+UdaSSRUbx6KBUW47uRmgA60hTI6Ux92crkfjS+YxHioAY0IJzmo2XFsmXjoajL57UARHmkpzeA4yPzPMXsMUAAPSDSbly01BZRnBFABSgm
eZz1pS/HA0aAGYDPjIH1pJQM/eBpu5g3TH1pGL54K/LQAw4PrS/
KB90sfrjFRmGQnPMfpmkMb55k5+LAEb53c1EUWjAXmPDGxzL6j2f7VAFeTOahdQw4q0yZPNVnTB64FAGPqfSPLLYqrpnzyEe9bF1ErW7/
ADVk2gAn0B0NAGpKf3v4VQuMlSirz/eBz2qrIBQA22Tc+0K00EcSTnChR1JqnbAB/eu38AeH01/W2uLyMPZwZBVGHDv/
AFoAm8PeDr7W4EUfQW9u30+aLlh7c81t3Pw0vFX9xe28rejQ7f6mvS1VUG0AADgAdpS0AFp0saZc6TdnBDQ0j9spgH3HNY7SNk7Q0PavofxHoLvr
mky28qAuATG20VavCH08xS3ET/fiyD9c4oAxpZ5s42dPQVB9o17R5NWJ1iWQ58zPfaKrN9m5y0/0A/
8AR0AJ510eLU1J5ty0sDCoWNmDw92D7KaaZbUDiW7/ACoAm+03Q6Q0aBdXQ/5YkVCIJG6TXZ9mGaXfHg4ef8eKAJHnct/
yyajzrkdYUarEeS8x+hoMlqOGNyf+4A5oAkeT0ekLU9zBz5BH1NV/Ns+63h/4DU8UcbfNGHI9GPNADz9rPSPn3ppF7/zx/
WpGHUKS6SA+3NQ7YiCCK4oAeBe4+4B9T57b3tH41H5cfe31P1FCSGI/dsXb6A0AIWvOm5B+NA+0g/NMn51IsJawNNk/76NKILH/
MHP1LGgBq7+9wgNPKsMf6TEPxpFJA0V09F9qeIm6Cy+iPUAKmc/
8AH5Hmp4o0kkCmZZD6AmkiGctxbWwPuymtK1jLRxm01H+6VzQBoWGLK5ULGS6DnmvUfD/AIQtrKfJrtFkmIztxwtc/
wCF4Y2det4hghI95Hqa9KHVQBA9lavHse3iK9MbrXPz4Nsb2FntFW3na+XA+VvqK6ekoA8G1XT57Cd4pVKyKcMPSsWU8Yr1r4haev2eK9QYP3H9
/SvJZhh2FACWwAeM/Nw0gXYMnFyvtvF46NmtkXAWm4oA3iSkIzZVouP7ufxqM742rQBWMjMaLUMFzk/
hS7UhbFG8A8GBMDFMYPDS0n+f4vzphLIHdy+lADWGTxthL1ppiiUHL4J/
CjvhcgdyAG7B85Q0TSlwKb5zKMksaFsgA2r2FJjHQGo2lPUGkM744cg0A0cD8ajY0m7PP0aYwZQ4AtikyCvXn6UxmGkMg9APwoAVuD1q0hnHem
llxwTQAxSYPNRHBz3A6053HY1DvKg4NAETkgMoPuvIvRgrK/
1rbdhuzmsLnr3jgEbc0ATluAKryNg1KzBfwqPI+5uKALlu3zivYfhTOP7MurfABD7s9zmvFoH+au98Da+mk6kDI37t+HHoPwgD3CioLS8t763We2
mWVG7rZu2cDqKAFJGDyK8GSSLD4kv1UjAxPT65r1DxT4otdPspYIJg05GDtP3RXhmoXzXF00hJ04+tAFA4mbeQs20em0f1FVmuJ0n2ka+pUVIxc
t8SUbxfFRyNko4t4D9cUAQncyBuNRiz/ALgo+0TLCEv0z6iNf8KXzps4+x2X1IGAqSxB/wBHtwfwoAi+0SqcG8Qn02gf0qQ7uw5nU/
8AARUTmcn5YLc/UilXz/4reED/AGWFADXPi0kw/wC+RSi6m7XK/wdFI/woHm7WxDB+LCK/f/8APvbfwoAX7RMf+XwD/gIq1aMectu561U3S/
8+1tn6ipIJ3ifdWiv/wBl8UAX7pL2H5ynH3hVASR5x9t/8dqW55yfkIqf7z5/pUfnS44FqB9M0ASB4e96x/
CLmtunBu5x9FNmV3bjfbfULTjI69J7ch/aWgBfTNoRgX8xPvxTfMtm0PtFy3+6acJZsf8AH9Av0WnLk4bnVUP+7mgBUityM/6Uf+B//
WqUR2ijm05P/A//AK1N884/4/WP0JppuVB5vJh+JoAtoLYcbrzk+7f/AFqt27oGyIPEPqRNSWMrzd3Dfh0/WpEkj8z5ZJW/
wb8GdvfCF+IPEdtK5A3LSPneyjGBivnCT2uTDIkqE7k0RZ0rL1QfH9u9miXquS05xiFn+Y60Ad7R9awm8YaMACL0X9LU5/
XFZepe07eCFjBQSFuzS/KB/U0AM+IOqW0ekNz7gZiwBHpivHJJN0prS1rVpNQumkZiQe5PNY30c5oAuW/
+uUfjWkAu0cVlWmPtIzWvtG0tAHQs46ACm+Zt5AZQVyetIVoAY75GKiJqRl5xTdpHbNAEZPPWk7JUpU0zaexoAQuycKxH0NjN0TTvn6cfjTWu0B
+FACFW64NM9qUhvU00qTQAxjtpQgKVsZIAqUI3BF0KPK300GgCqW0eLBJxyB+dTG5IyVhVubRnpkUAQdRSJGXykg7Q0eakMBDiZTnPLAMTigBkg
T+Ak/WomARc8fcg1P5Y37VP4VE0RzjCtI4bA2ge9QkehZVp4uahKle3NAFWfPkvz4rDswPmPk966CRDIhX1rGtLc/
aJuzg0A0cnk1WLD8avvaR4IERd/g0f61AunSMdsLvYjBoARLIVYVpW9zggq21vUHFVInLVq58i0MD/
ac4ArYj8F6r1WeA59DQBoaf4iuLCfkiEybjktazLgJ9cE7c/hV0+LZ5IijS6xI3b7ReKFH/fsisb/AIQ3XR9xom/Gkbwpr6dIYm/7aH/
Cgaur2W6ytJIOvQGs58FuoqW40LW4c7rGVg0pj0f8KznWSJisodG/2xQBjIqknMW+q7Qn/n1fHmpoUaQ8PgvJZay+WUt7ZoAo+Qp/5dT/
30f8aDeu3AtT9M11XhvwTPrkm67uZ7eAcnycb1Pqa6uf4Xef/Led3q4fuxnTn8ntAHk/kr3tT9M0eSueLV/
wDvqvULZ4PJ5Ql0vxDdKD0jmiEn54IrAuvhp4ltyfJubK4H+0TGF60AcmsS4x9jP5n/ABpnLKucWR/76P8AjXQn4I8WRHnT4ZB/0znz/

```

wCy0w+EFe+edJL/BgaAMLYE/wcFM/8AFr/xqSOMo2Rbsv1NbH/CKeJ8caLcN9MGk/4RXxQSB/Y8o+poAyXVSfmtA31ajy4e1lHn/eb/
ABrVPhLxPnnSWH1f/wCtT/8AHEPFJ/5haD6y/wD1qAMtdqniXj/76b/GnvtpbaQZ9yf8a0f+EP8AFH/QPh/7/wD/ANjTh408TZ5s7RT73J/
+JoAydj5/497dfxNL5cvVfTlPqTW4ngXxA4zILGL388t/Spk+HmpN/rNTso/pEW/rQBhI1yg/1lv+F03XOP8AWW/4qK3/APhW160V1e2Y+1sf/
i6jPgDWY2/dzWsw+pU/1oAx f9I/5+IR7BF/wpRjJ78wb6AD+QrZHgrV1b57S3/3vOP+FWI/h/qk3/L5awZ9VL/
1FAGPHdxjgtmrEd6kUm+GaSKX+9G20/pw/B8LbokNP4gtwP8AYtuf/Qq1ofhnpzm/AEjxFPn/AGEC/wCNAHIDWb/
dk6jIx9TDGT+e3NMm1KafBmuJpT/t5xXdL80fCyd974ivCfQyKP6Up8EecYP9Zq13N7CUf/E0AecSSg85psT5bAbNd/c+G/
BlrC8ls8vmgZBds5rnZLzTFb92NrD/AGP/
AK9AGdAwW6VsefpWupG3k4qtNrNoVAdAcDgXg0v2mIjIdeaA0p3D1prSdgajPwk0B3oAcTjrzSfX2qIk+tJQBjuU00lQaYTSdqAHBlppPNMJpu40
A03KAQ2fwpAwHQfjUeaazEHAoAsnYmFpj1xTDIoyFZiPeoQ3FNoAeXAPFBJI45qPqcZXTdxPyhvyoAcxb8ah0S3PFKwA4DGZLZIUUKMdeaAG5dfu
sR9DUbn7kn3pWIBzkfSmvJF5QAVt/rkUAMZvWoJHPalZHUtnnigBN+GHesMn8X87CtAnDZqhHEy3E7EcEUAIZ/
mpouGQ5Q4PtVSWXa2MZpv2HmcofzoA2ba4kkf5pGPHrV5LmSBdWYfjXOW95GsnJKitMXEcsY2SZFAGnHr14px5zAVdgs3k3f3J/
zFc8do6UKwHegDr4fGF0CA6wSD1ZcH86tN4l0m7XZfWEbg9S9CD/
wChVx04c81Ex3elAHvyWPg2509L+wYy9LAIH4UCz8LQ0jDVZbnb28rbXGuFBpmcdQB6aPGmnWUQt7Kym2gYJBUZ/
Wor43gZLZayuCOp+Zf8a868w44Y0zecz8k/nQB7Bp3jmxUERWUimf+ekg/qatP4xhLJDMmf8DU/
1ryjTWAXMmCueNxdqtSt0bH2eTgcb1TIH44oA9I/4SGyk5IJ/3WFJ/
btkeN34ZBrza+WfaZorsxKei7etKi3JtFc30xwMk7Qc0AehtrtqjZ5P1ZR/WkPiOywcipPvKv8AjXmqXVyLeWR5d/
OASopiTFJSPKkwIycKOKAPRW8S2Y+75R+ky/403/hI7P2z/
vqf5VxPnW+2JhAh3nHQUX7vax8q0Dqp+Y5AxQB3J8S2gGMJn3BP8hUb+KbRV3FoV7fcb/
CuN064iJjbywazwX8tI1YHBJ+Y0AdxN4ytoeDJFk9MAjP6VWl8Zz7P3UDDmhsLj+dcplJHJbLvEYf0P9Ke0jm3I8sqqrQBqP431PdwpH4mo28Yao
w+8R+Nc4Z0eaXzVFAHRf8ACX6xjHmgfUA1E3ijWGGDOPw7VhidfWl+0JjrQBqntTc83LfmaitG/
JJ+0kH8TWd9oHY0huA0c0AaP2u7f70+f+A00yzkcyk/hWeLodmFH2r/aoAuq02eZG/0o9pLHJJquLrB60gucHrQBZRA0yjHetxIvKHB/
OsG1k3XC10Sk7RQB0WeyX5qQ4JprYxigCM0l0xRiMqBhs0AMJFC4ZfenFRTB8tAEZ60bQXSUexpUdaZQAzig0/FMYCgB0x5FMyet070Pg/
dFAEZkY8EL+HFihw3AGnFowMLuz70xiAMjrQAVmRrnain/AHLzj8ajJ3nnI/
3RTsjbjvTPRQBA6nPQ1G4I710etNKBjy2PwoAqEHNrkHsKsuB90EH36VCyLTyQfoaAIGUg81XlkCo3PUVZc8YFUbgcGgDJmPzetQnK9DU033jU0e
1ADDxviC6aMbBUBpF4egC6b2UVG2pSZ6c1HkDrUZ2Z6UATjUpuxxR/aEp96gIXFMwBxQBZN/
JnnFOS6J5NVNtKBgYFAGkJoZxuNKXGPvVndTyaeGI6GgDotNljMJRwG9MiomhkZtqpJy2e0LYgkZT8rEfQ1KL24T/lS/
8A30aA0iuXuWxyntxLHjgrjINSL9qiteUQeZ/eUsMgVzF9o3A6Sv8A99Gmm9nb/lq//fRoA60ziMuciy0EDHhSRxUS2pBkcJGhIABrn/PlPWRj/
wI0eY5/jb86ANv7IU8pi2CDlvm6UxneIugmiKMeSW0f5Vjh2/vE/jSbj3oA6CG6ihj2eap/
OmebbkfnIHgc1hbyPSjct1oA22mt8DbMgI9ajmvkELIJAxIxxWNgeLLQA55utQeax43GpcDvShB6UAQh29TS/
OematKiDqKLUq0gFAFJY5WPBNTNaIItxY5q4pUcJGaJ2BhNAGQWInPQk+tI3XpTkHegB4zT16Cmpf6UAXrD/j4SumU/KOa5rT/
wDj4WukjA2DLY/
CgDoST2oXJ680c89aaSS0TQArAjsRTQKdxs4zn3ptABmk0McEUh0KQKxb5ULfSgABXB3HFRgAnG7HvinOpU8qR9ajIFAA4QcK5P4VEc1LkY60wgd
jQAZkHtQelKV96Ta2MkGgBhAapmM8VJwaTAHegBhHb1om46EVI/
eof1oAcrAAggHPRSSZXqMUMjqqpH1qLkHFAEBYzUDsTurH5qiPNAE02q9x901dBXBGKz7ttiketAGPL981CRT3JzSdqAI6TpTu1RseKAHbvU0m5a
i5pR1oAkzRTaTJoAfS00cU6gA7UUUUALTWuRzTaXmgBCKUD6XFFABTqbThQUAZpKwG7A0ULHNAB0pc0LFAC5pc0yLzzQBjuNKHxUeaM0ATrLTmky
hFVS2KQt6GgBG60q03NPHSgB4p46dajpRzQBraUuZq6IHARc0dWat3HvQB0ThjpuJNTP0qHvQA3/PWLJ9DTW60v8ADQA5o3CgLDtPem/
dPyuQfal/5Zmo/
T60APC+bn5mL+nXNRshHB4+tKn+tpvc0AR4560jfwN016AEHbPpJ6BiAe2aUU00AM6HFkV+brQfvUv8dAERBYaiYYP3gPwzUzfeNQP96GJJ3i1
RlWNTdqZ2NAFZk56UwpVioX980AVXBHQVRvL3Jkda13+4azbr7poAwH4JzUe72qaf75qV3oACaa1KaaetAdcGnq00tFKKAFx700Kc5p9LQAmKMUo
60p60AMpaUdaU9aAACncikFLQAUUtJQAuKKKKAeOopRQAUUtFACYoxS0UANxRiLpRQA3BopxptADTSFeM0ppKAepwimnrQKAJQafGCWwKjFWLX/
WUAdDpcRWIDvmtPPqKpad0FaDdaAP/Z"
}
]
}

```

6.8.1.4.4 Response example:

Single-frame:

```

{
  "results": {
    "color": {
      "error_code": 200,
      "tags": [
        {
          "id": 0,
          "color": "",
          "probability": 1
        }
      ]
    },
    "mmt": {
      "error_code": 200,
      "tags": [
        {

```

```

    "id": 0,
    "make": "",
    "model": "",
    "type": "car",
    "probability": 1
  }
]
}
}
}

```

6.8.1.4.5 Response parameters:

Parameter	Parameter description
type	Vehicle type: noise, bus, car, motorcycle, small bus, truck
Other parameters	Used to maintain API compatibility

6.8.2 ULPR Server

The **ULPR Server** corresponds to the **LPR channel** system object.

6.8.2.1 Image receiving by the ID

If the images are stored in the local or network folder (see [Configuring the recognized LP images and vehicle images storage on disk](#)) you can access them via the HTTP GET-requests.

GET `http://IP-address:port/lprserver/GetImage/{type}/{id}`

Parameter	Required	Parameter description
id	Yes	the image ID (image file name without the additional <code>_Frames</code> or <code>_Plate_numbers</code>)
type	Yes	<code>Frames</code> - request means accessing the main image, <code>Plate_numbers</code> - request means accessing the LP image cut from the main one

Example request:

GET `http://127.0.0.1:10001/lprserver/GetImage/Frames/66FB34A2-1B38-E811-A92F-001A7DDA710E`

GET `http://127.0.0.1:10001/lprserver/GetImage/Plate_numbers/66FB34A2-1B38-E811-A92F-001A7DDA710E`

Response example:

JPEG image

6.9 Appendix 9. LPR channel integration via TCP/IP

For remote systems, it is possible to receive events from the LPR channel. The Server with the running *Auto-Intellect* software acts as a TCP Server.

When a new LP number is added to the *Auto-Intellect* database, the Server transfers the data via the **TCP port 35555** and **TCP port 55555** in the following formats:

6.9.1 TCP port 35555

```
<?xml version="1.0" encoding="UTF-8"?><CAR_PLATE version="1.0" direction = "in" cam-id = "4"
time = "2020-07-21T18:37:44.695" plate = "x000xx000" plate_mask = "" confidence = "99"
plateImage = "imagebase64" >..imagebase64..</CAR_PLATE>
```

The transmitted data structure is described in the table below.

Name	Description
direction	Vehicle moving direction. The following values are possible: <ul style="list-style-type: none"> in – To the camera (defined by Vehicle license plates) out – From the camera (defined by Vehicle license plates) left – On the left (defined by carriage, container numbers). right – On the right (defined by carriage, container numbers). none – Not defined
cam-id	ID of the camera that captured the vehicle
time	Time of LP number recognition
plate	If the LP number was recognized, the field contains the text of the recognized number, otherwise - "Not defined"
plate_mask	Country the recognized LP number belongs to
confidence	Accuracy of LP number recognition in percent
plateImage	License plate image in "base64" format
> ..imagebase64.. <	Vehicle image in "base64" format

6.9.2 TCP port 55555

```
0x02YYYYMMDDHHMMSSCCNNNNNNNNN0x03
```

The transmitted data structure is described in the table below.

Name	Description
0x02	Start byte
YYYY	Year (four numbers 0000-9999)
MM	Month (two numbers 01-12)
DD	Day of the month (two numbers 01-31)
HH	Hour (two numbers 00-23)
MM	Minutes (two numbers 00-59)

Name	Description
SS	Seconds (two numbers 00-59)
CC	Camera number (two numbers 00-99)
NNNNNNNNN	Text of the recognized number (arbitrary number of symbols), or "Not defined" if the number was not recognized
0x03	End byte

Note

The beginning and end of the message are transferred by the start byte and the end byte respectively. The message between these bytes is transferred in text format.

6.10 Appendix 10. Selea CPS (Car Plate Server) configuration guide

6.10.1 Brief description of Selea CPS

Selea CPS (Car Plate Server) is a software server to which *Selea* cameras with license plate recognition are connected. This software server redirects license plate recognition events from *Selea* cameras to the *Auto Intellect* server.

6.10.2 Configuring the Selea CPS server

For the *Selea CPS* server to work, it is necessary to install the **CPS sever**, **CPS discovery** and **Seleatool** utilities on one computer. Also, the cameras and *Selea CPS* server should be in the same local network.

Note

Outdated modifications of *Selea* cameras can work in the same local network directly from the *Auto Intellect* without the *Selea CPS*.

The server is configured using the server web interface or the manufacturer's utility *CPSConfig*. Below is an example of configuring a server using the manufacturer's utility *CPSConfig*.

To start the *Selea CPS* server service, go to the **Local Service** tab, specify the server login and password, camera port for events, and other parameters, and then click the **Start service** button. When the server is started, the utility will ask for the server login and password.

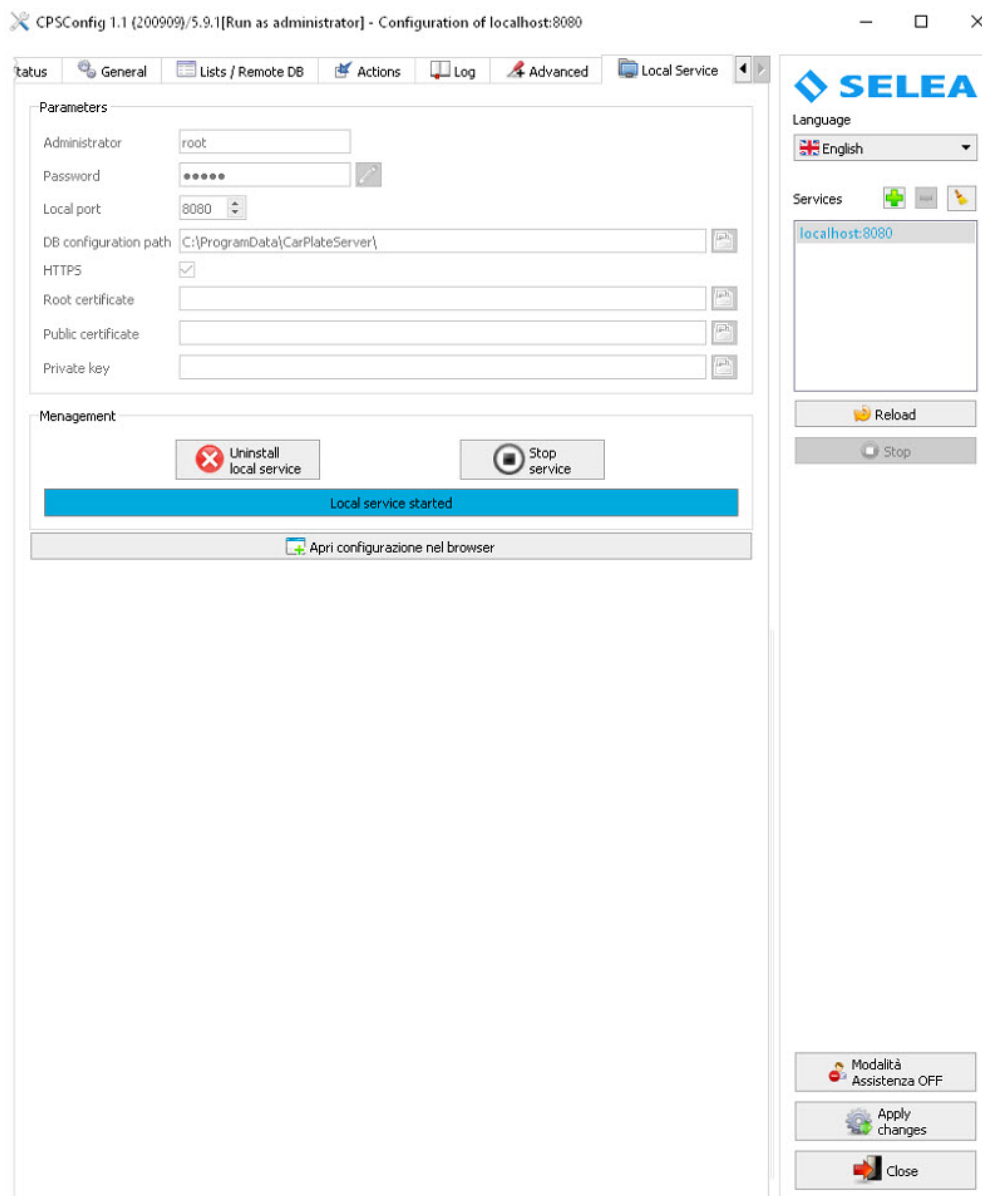

The server can forward events from cameras either by itself by opening a connection (ftp, http, or tcp), or to an open client via tcp connection. The latter mode is preferable because it allows you to control the connection without problems with port forwarding on the AN server side.

In order for the server to receive the incoming connections from *Auto Intellect*, it is necessary to enable **Notification forwarding** on the **Advanced** tab, set the used port (5666 by default) and add the *Auto Intellect* server address to the **Access list without authentications** field.

Below is a configuration option when the *Auto Intellect* server is installed on the same computer as the *Selea CPS* server.

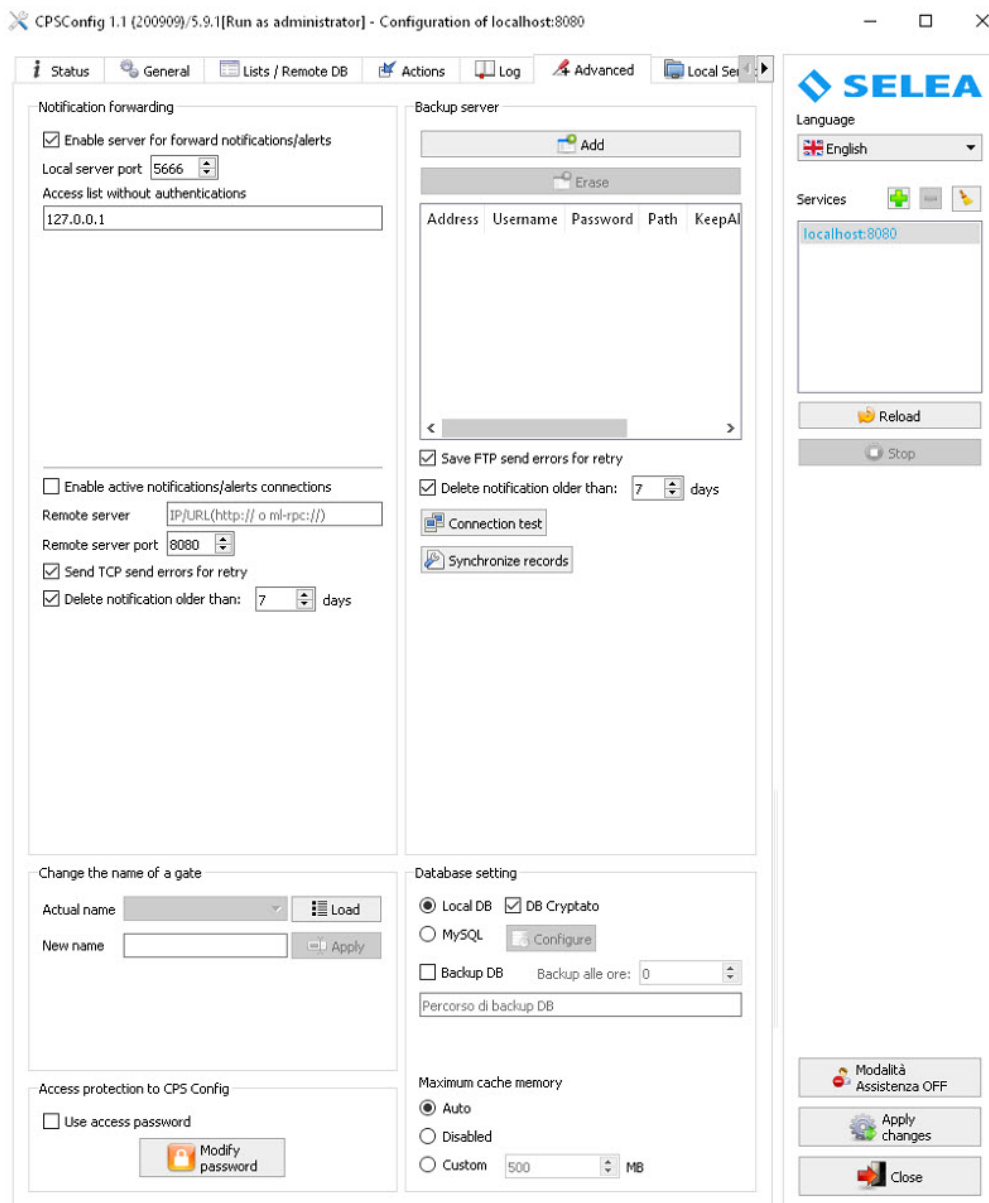

Also, in the `C:\ProgramData\CarPlateServer\passive_gateway_carplate_template.xml.utf8` file, it is necessary to set the format of the transmitted events as follows:

```

Begin{
COUNTER=$COUNTER$
CAMERAIP=$CAMERAIP$
CARPLATE=$CARPLATE$
TIMESTAMP=$TIMESTAMP_MS$
IMAGE=$FILE_B64$
IMAGE2=$CONTEXT_B64$
}End

```

Here for the **IMAGE** parameter specify the value `$FILE_B64$` (to get a black and white image). For the **IMAGE2** parameter specify the value `$CONTEXT_B64$` (to get a color image).

6.10.3 Configuring the Selea cameras

In order for the *Selea* cameras to transmit the license plate recognition events to the *Selea CPS* server, go to **SETUP** → **NOTIFICATION SERVICES** → **FTP** in the camera web interface and specify the *Selea CPS* server data.

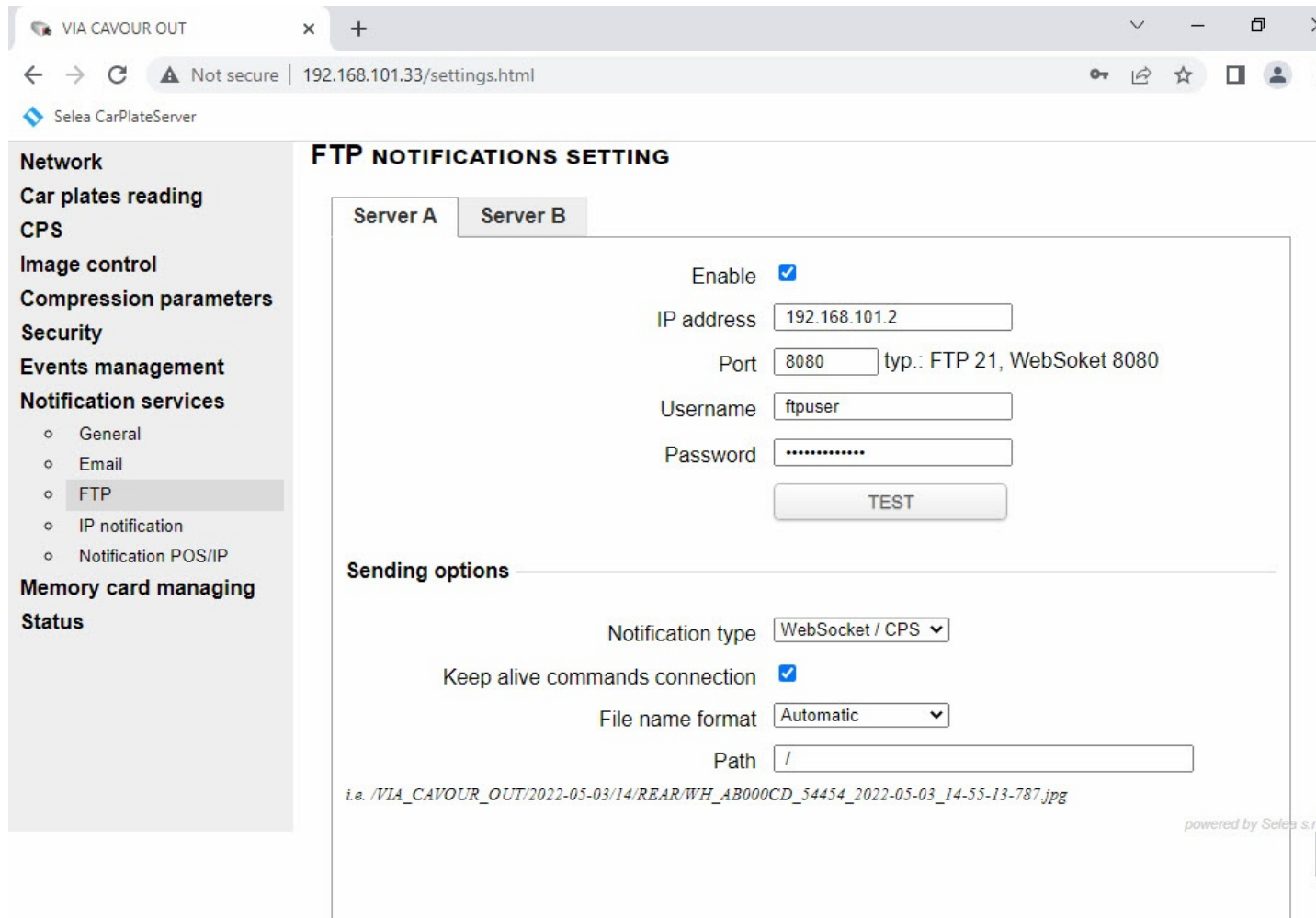

Since the cameras do not have embedded GPS, in order to transmit the geographical coordinates of the *Selea* camera, go to **SETUP** → **SYSTEM** → **GPS COORDINATES** in the camera web interface and specify the corresponding camera coordinates.

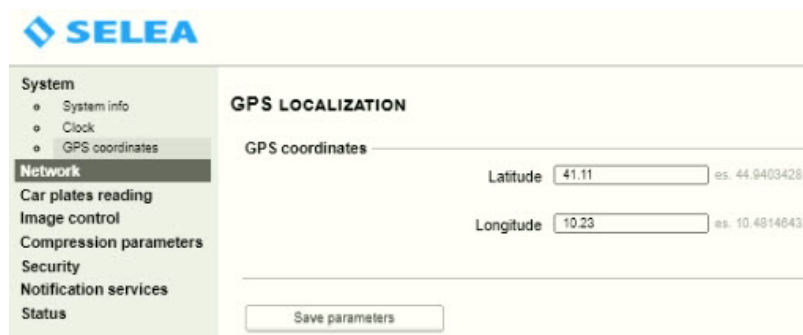

6.10.4 Configuring Intellect to work with the Selea CPS

In order to get a response from the *Selea* camera with the help of *Selea CPS*, do the following:

1. Create a **Video capture device** object.

2. In the **Video capture device** settings:

- a. From the **Type** drop-down list select **Selea** (1);
 - b. From the **Model** drop-down list select **ANPR camera on CPS** (2);
 - c. From the **Firmware** drop-down list select **auto** (3);
 - d. In the **IP address** field specify the IP address in the format [ip_camera_address]@[ip_CPS_server_address]. If *Selea CPS* is installed on the same computer as *Intellect*, then the **IP address** field value will be 127.0.0.1;
 - e. In the **Port** field specify **5666** (5);
 - f. In the **Name** (6) and **Password** (7) fields specify login and password of the *Selea CPS* server (see [Configuring the Selea CPS server](#) section);
 - g. Click the **Apply** button (8).
3. On the basis of the **Video capture device** object, create a **Camera** object.

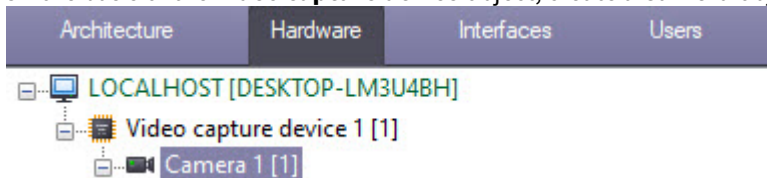

4. In the **Camera** settings, go to the **Stream settings** tab (1) where you can configure camera video streams:

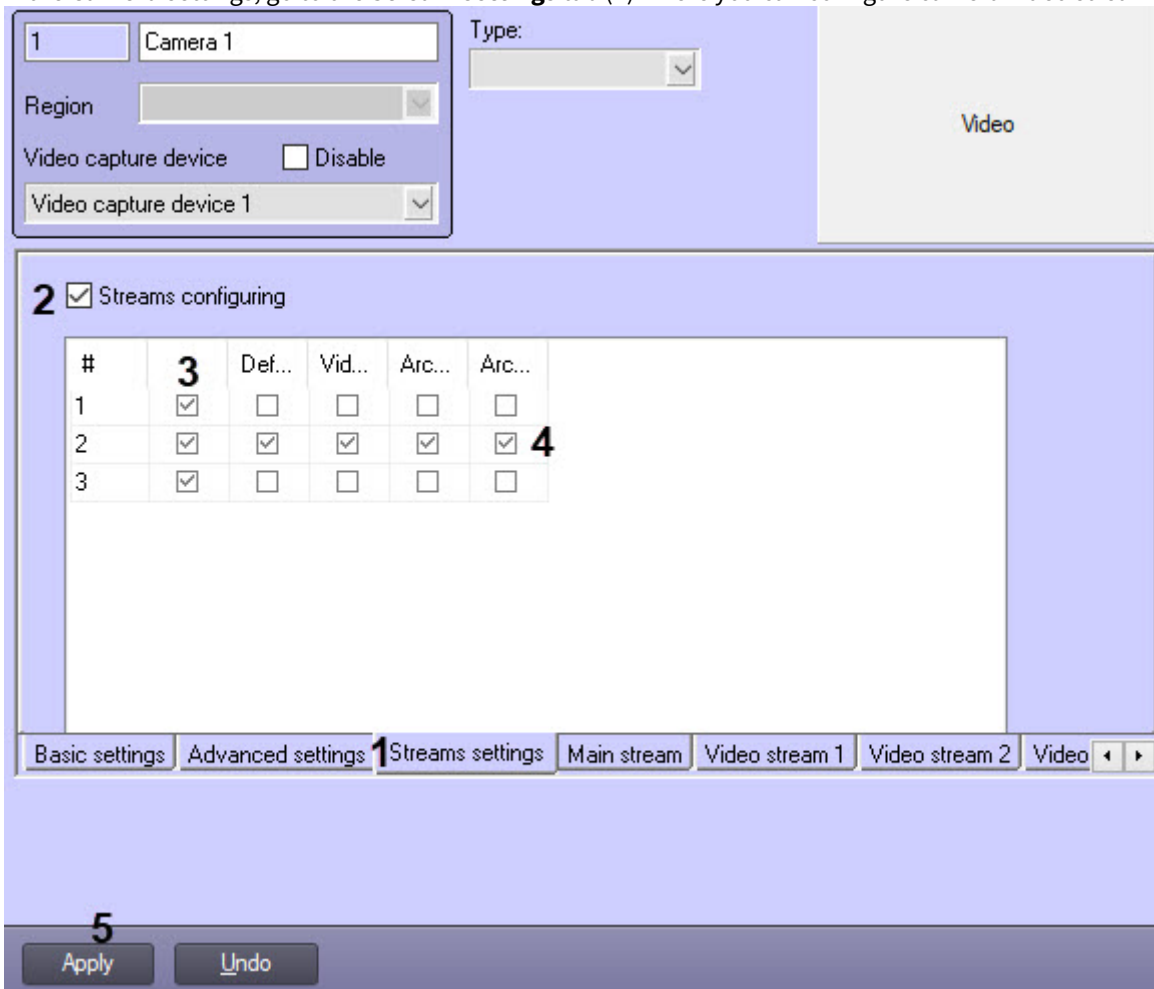

- a. select the **Streams configuring** checkbox (2);
- b. activate all three streams by selecting all boxes in the first column (3);
- c. select the remaining checkboxes for the stream 2 (4).
 The first stream is the video from the camera. The second stream is color images from the camera in the moment of license plate recognition. The third stream is black and white images in the moment of license plate recognition. You can see them in the **Online Monitor** window.

5. On the basis of the camera create the **Embedded detection** object.

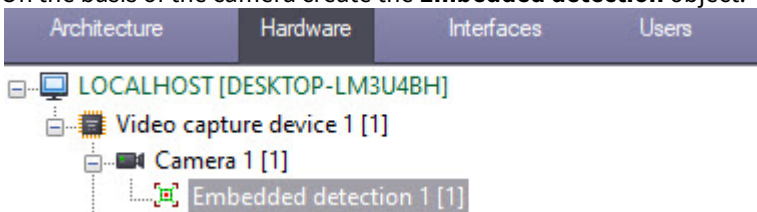

6. In the **Embedded detection** settings in the **ID in device terms** field (1) specify the value of **IprDetector** and click the **Apply** button (2).

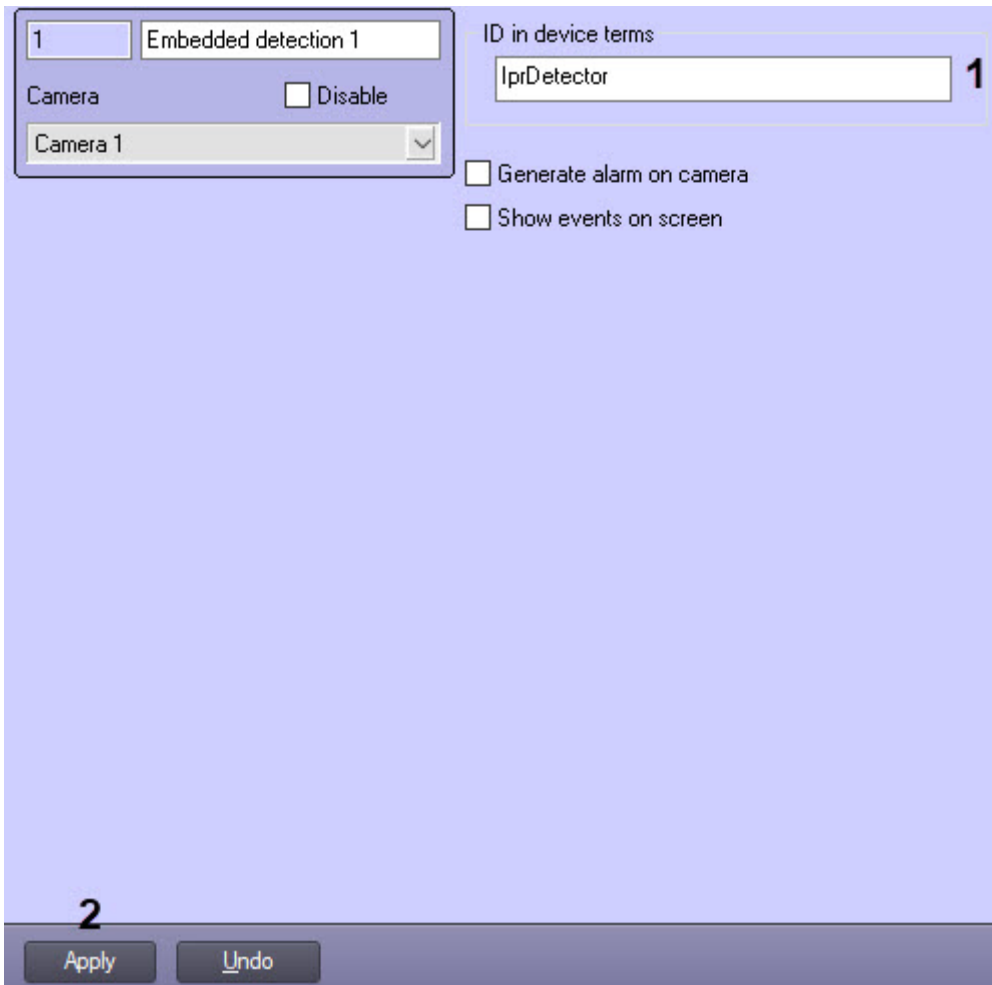

7. Create the **LPR channel**.
8. On the basis of the **LPR channel** create the **Remote recognition** object.

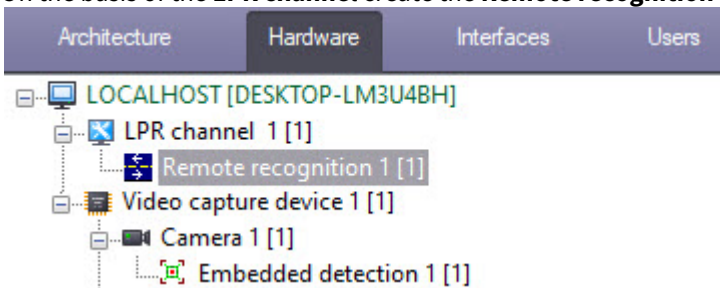

9. In the settings of the **Vehicle Tracer** Interface object choose the created **LPR channel (1)** and click the **Apply** button (2).

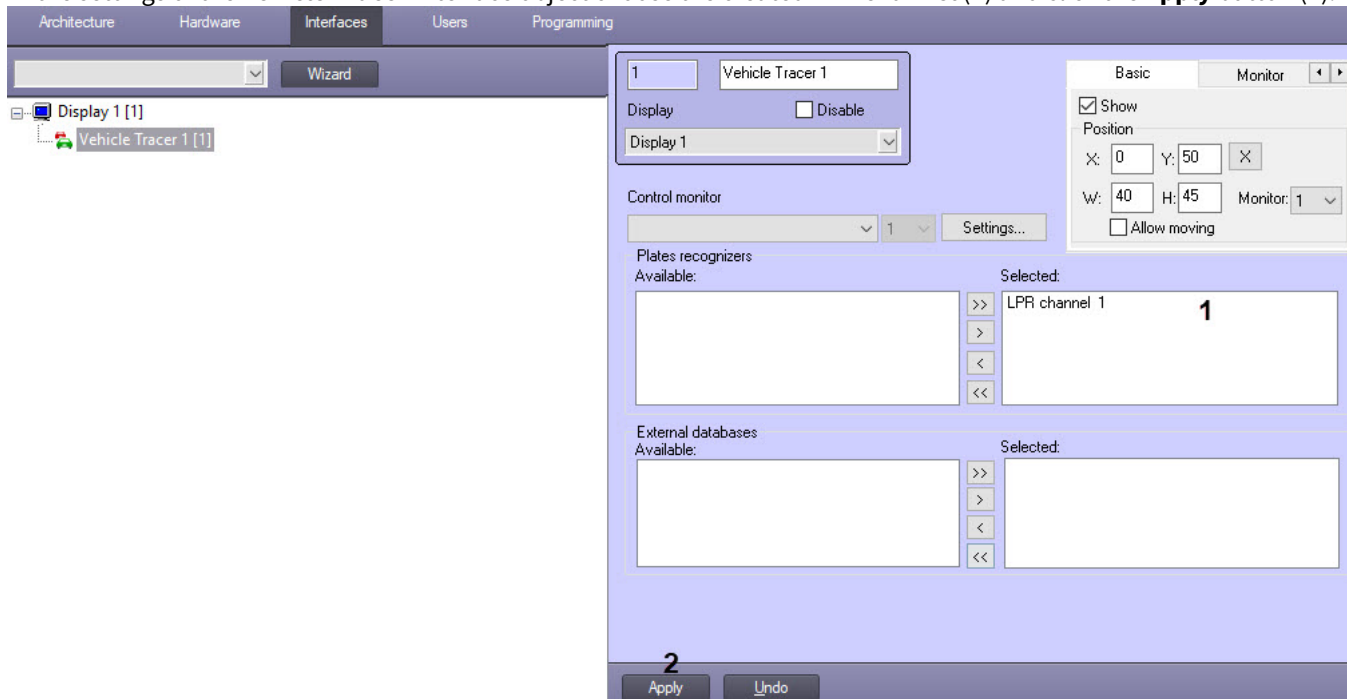

Intellect configuration for working with the *Selea CPS* is complete.

6.11 Appendix 11. Examples of correct and incorrect video images for the LPR IntelliVision software module

Video images that meet the video camera mounting and setup requirements for the *LPR IntelliVision* software module (see [Video camera mounting and setup requirements for the IntelliVision software module](#)).





Video images that do not meet the video camera mounting and setup requirements for the *LPR IntelliVision* software module.

