



Installing and configuring security system components guide

PSIM 1.0 (english)

Last update 11/07/2022

Table of Contents

1	Installing and configuring security system components guide.	
	INTRODUCTION	8
1.1	Purpose and structure of the guide	8
1.2	Purpose of the Axxon PSIM™ software package	8
2	Installing security system components	9
2.1	Assembly and installation of video surveillance subsystem hardware	9
2.1.1	Installing video capture cards into computer case	9
2.1.2	Installing drivers for video capture cards	11
2.1.3	Testing installation of drivers for video capture cards	16
2.1.4	Testing installation of drivers for video capture cards using the Codereader.exe utility	18
2.1.5	Special features of Driver Pack updating for YUAN cards	19
2.2	Connecting the hardware performance testing	20
2.2.1	Connecting the Watchdog hardware performance tester	20
2.2.2	Connecting the USB Watchdog hardware performance tester	23
2.3	Connecting Sensor-Relay cards	25
2.3.1	Connecting 4/4 and 16/4 Sensor-Relay cards	26
2.3.2	Connecting 4/4 Sensor-Relay (low profile) cards	31
2.3.3	Connecting SL USBIO cards (4x4, 16x8 and 24x4)	37
2.3.4	Connecting MO USBIO 4x4 cards	40
2.3.5	Connecting AGRG-IO-16/8-WD-DS Sensor-Relay cards	42
2.4	Connecting MO USBIO 4x4 external module	44
2.5	Assembling and installing hardware components of audio subsystem	45
2.5.1	Supported audio cards and other audio input devices	46
2.5.2	Options for increasing the number of audio input channels when standard audio cards are in use	46
2.5.3	Installing audio input devices	47
2.5.4	Installing microphones and loud speakers	47
2.6	Connecting PTZ devices and control panels	47
2.7	Connecting and configuring network devices	48
2.8	Installing the expansion card for analog video out	48
3	Configuring security system components in Axxon PSIM™ software	50
3.1	Configuring video capture cards in Axxon PSIM™ software	50

3.1.1	Video subsystem configuration.....	50
	Creating and configuring the Video Capture Device object.....	50
	Creating and configuring the Camera object	53
	Configuring the analog video output.....	55
	Configuring HikVision video capture card	57
	Configuring YUAN PD652 video capture card	57
3.1.2	Audio subsystem configuration	58
	Creating and configuring the Audio card object	58
	Creating and configuring the Microphone object	60
3.1.3	Initial configuration wizard	62
3.1.4	Configuring the Watchdog hardware performance tester.....	64
3.2	Configuring IP devices	66
3.2.1	General information on IP devices.....	66
3.2.2	Configuring video acquisition from IP devices.....	67
3.2.3	Configuring audio acquisition from IP devices.....	68
3.2.4	Configuring the access to the archive in edge storage	69
	General information on keeping video archive in edge storage.....	69
	Creating the Edge storage object.....	70
	Setting the list of cameras to access the edge storage	70
	Importing from edge storages.....	72
3.2.5	Camera discovery tool	73
3.2.6	Connecting devices over standard protocols.....	77
	Configuring multimedia receipt using RTSP protocol	77
	Connecting cameras via the GB/T28181 protocol.....	80
	Connecting devices via FFMPEG driver	94
	Connecting devices via the ONVIF protocol	104
	Using Generic Drivers (General device, generic)	105
3.2.7	Features of IP device configuration	107
	Features of Beward IP cameras configuration	107
	Features of Panasonic IP devices (i-Pro series) configuration.....	107
	Features of TrendNet IP device configuration.....	107
	Features of Pelco Spectra IV IP device configuration.....	107
	Features of AEBELL IP device configuration	108
	Features of Dynacolor IP device configuration	108
	Features of Stream Labs IP device configuration.....	108

Features of Cisco IP device configuration.....	109
Features of Mobotix IP device configuration	110
Characteristics of joint operation of Jassun and Bosch cameras	110
Features of configuring ONVIF or Hikvision IP devices behind NAT	111
3.2.8 Changing the transport protocol used by IP-device	112
3.2.9 Digest authentication when accessing IP device	113
3.2.10 Configuring getting video from web cameras via HTTP protocol	113
3.3 Configuring Sensor-Relay devices in Axxon PSIM™ software	115
3.3.1 Creating and configuring the Relay system object.....	115
3.3.2 Creating and configuring the Sensor system object	116
3.3.3 Creating and configuring connection with the Analog sensor (input)	118
3.3.4 Configuring Sensor-Relay expansion cards.....	118
How to configure relay connection.....	118
How to configure sensor connection using 4/4 Sensor-Relay card	121
How to configure sensor connection using 16/4 Sensor-Relay card.....	124
3.3.5 Configuring Sensor-Relay expansion cards (low profile)	126
Connecting relays of 4/4 Sensor-Relay expansion cards (low profile)	126
Connecting sensors of 4/4 Sensor-Relay expansion cards (low profile)	128
3.3.6 Configuring SL USBIO cards	130
Features of running the SL USBIO 16x8 card drivers.....	130
Connecting relays	130
Connecting sensors.....	130
3.3.7 Configuring MO USBIO 4x4 devices.....	131
Connecting relays MO USBIO 4x4.....	131
Connecting sensors MO USBIO 4x4	132
3.3.8 Configuring sensors and relays connected via IP devices	133
3.3.9 Configuring AGRG-IO-16/8-WD-DS Sensor-Relay cards	134
3.4 PTZ configuration	137
3.4.1 Use of PTZ devices in the digital video surveillance system.....	137
3.4.2 Priorities of PTZ control.....	137
3.4.3 Configuring PTZ devices (telemetry).....	139
PTZ device setting procedure.....	139
Configuring Server ports and remote workstation to connect PTZ devices.....	140
Configuring PTZ devices in Axxon PSIM™	141
3.4.4 Configuring Control panel	143

Features of BOSCH KBD-Digital or BOSCH KBD-Universal control panel configuration and operation	145
Features of Axis T8310 control panel configuration and operation	150
Features of Lilin PIH-800III control panel configuration and operation	157
Features of Panasonic WV-CU950 control panel configuration and operation	159
Features of Samsung SSC-2000 control panel configuration and operation	164
Features of EverFocus EKB200 control panel configuration	165
Features of Samsung SPC-7000 control panel configuration	166
Features of using VIDEOTEC DCZ keyboard.....	167
3.4.5 Configuring PTZ IP cameras	168
Configuring control of PTZ IP camera using the control panel	169
Features of Vivotek Panoramic PTZ configuration.....	170
3.4.6 Telemetry control panel configuration.....	171
3.4.7 Creating and configuring the Operator query panel for telemetry control	172
3.4.8 Configuring the Monitor for telemetry control	173
3.4.9 Configuring the joystick for telemetry control	173
Configuring joystick using Windows OS tools	174
Configuring the Control Device object.....	180
3.4.10 Configuring the mouse buttons to control PTZ devices	188
3.4.11 Configuring functions for tracking moving objects.....	190
Tag & Track configuration	190
Using absolute telemetry	193
3.4.12 Patrolling configuration.....	203
Creating a route for patrolling.....	203
Running and stopping the patrolling.....	204
4 Installing and configuring security system components guide. Appendices	207
4.1 Appendix 1. Features of video capture card configuration.....	207
4.1.1 Drivers for video capture cards, sensor/relay cards, Guardant and USB Watchdog integrated into Axxon PSIM	207
4.1.2 Features of video subsystem configuration	208
4.1.3 Features of audio subsystem configuration	211
4.2 Appendix 2. IP device configuration in the Windows OS	215
4.2.1 Configuration of IP devices by the example of Axis camera	215
Searching for IP devices.....	216
Assigning network addresses to IP devices	217
How to call the Web Server home page of IP device	221

Configuring network parameters of IP-devices using the Web Server	224
4.2.2 Features of configuring Axis IP devices	227
4.2.3 Features of configuring IP devices using the Web interface	227
Features of configuring Panasonic IP devices (i-Pro series) using the Web interface	228
Features of configuring Samsung IP devices using the Web interface	228
Features of configuring Mobotix IP devices using the Web interface	229
Features of configuring Sony IP devices using the Web interface	229
4.3 Appendix 3. Technical specifications of video capture cards	230
4.3.1 Technical specifications of FS-5, FS-6, FS-16 and FS-8 video capture cards	231
4.3.2 Technical specifications of WS-6, WS-7, SC390N16 (WS16) and WS-17 video capture cards	233
4.3.3 Technical specifications of SC300D16 (FX8), SC200Q4 (FS15), SC300Q16 (FX4), SC310N16 (FX16), SC330Q16 and SC330D16 video capture cards	235
4.3.4 Technical specifications of SC200Q4 Low profile (FS115), FX2, SL16-200 (FX116), FX416 and SC230N4 video capture cards	238
4.3.5 Technical specifications of SC3B0N16 (WS216), SC510N4 (FX HD4) and MS416 video capture cards	241
4.3.6 Technical specifications of DS-4016HCI(R) and SC590N4 video capture card	243
4.4 Appendix 4. Video capture cards pins	246
4.4.1 FS-5 video capture card pins	246
4.4.2 FS-6 video capture card pins	247
4.4.3 FS-16(Exp) video capture card pins	248
4.4.4 FS-8 video capture card pins	249
4.4.5 WS-7 video capture card pins	250
4.4.6 SC390N16 (WS-16) video capture card pins	251
4.4.7 WS-17 video capture card pins	252
4.4.8 SC3B0N16 (WS216) video capture card pins	253
4.4.9 SC200Q4 (FS15) video capture card pins	255
4.4.10 SC300D16 (FX8) video capture card pins	256
4.4.11 SC300Q16 (FX4) video capture card pins	256
4.4.12 SC310N16 (FX16) video capture card pins	257
4.4.13 SC200Q4 Low profile (FS115) video capture card pins	258
4.4.14 SL16-200 (FX116) video capture card pins	259
4.4.15 FX416 video capture card pins	259
4.4.16 VRC6004 video capture card pins	260
4.4.17 VRC6008 video capture card pins	260
4.4.18 VRC6416 video capture card pins	261
4.4.19 VRC7008L video capture card pins	262

4.4.20 VRC6404 HD video capture card pins	262
4.4.21 SC510N4 (FX HD4) video capture card pins	262
4.4.22 MS416 video capture card pins	263
4.4.23 SC230N4 video capture card pins	264
4.4.24 SC590N4 video capture card pins	264
4.4.25 SC330Q16 video capture card pins	265
4.4.26 SC330D16 video capture card pins.....	265
4.4.27 SC3C0N8-L video capture card pins.....	266
4.5 Appendix 5. Electrical and technical specifications of Sensor-Relay cards	266
4.5.1 Electrical and technical specifications of Sensor-Relay cards.....	266
4.5.2 Electrical and technical specifications of 4/4 Sensor-Relay (low profile) cards	267
4.5.3 Electrical and technical specifications of MO USBIO 4x4 devices	268
4.5.4 Electrical and technical specifications of SL USBIO (4x4, 16x8 and 24x4) card	268
4.5.5 Electrical and technical specifications of AGRG-IO-16/8-WD-DS devices	272
4.6 Appendix 6. Maximum number of presets for IP devices	273
5 Installing and configuring security system components guide.	
CONCLUSION.....	276

1 Installing and configuring security system components guide.

INTRODUCTION

On the page:

- Purpose and structure of the guide
- Purpose of the Axxon PSIM™ software package

1.1 Purpose and structure of the guide

[Installing and configuring security system components guide](#) is a reference and information guide that is designed for system administrators, installation and configuration engineers, users with the rights to administrate *Axxon PSIM™*-based digital video surveillance and audio surveillance systems.

This guide contains the following information on:

1. How to install security system components.
2. How to configure security system components in the *Axxon PSIM™* software.
3. Appendixes that contain supplemental information on security system components and features of their configuration.

1.2 Purpose of the Axxon PSIM™ software package

The *Axxon PSIM™* software is designed for the deployment of industrial scalable, flexible (adjustable) integrated security systems, based on the digital video surveillance and audio monitoring systems.

The *Axxon PSIM™* software possesses the following basic features:

1. Integration of digital video surveillance and audio monitoring systems with the existing data systems, various security equipment, auxiliary software of other developers, using integrated open interfaces of the data exchange.
2. Compatibility with diverse security devices and data systems, in particular, with the fire and security alarm and access control systems, video cameras, data analysis systems and systems for recognition of objects (events) and identification by their images.
3. Single-source registration and processing of events, generation of notifications and controlling response in accordance with the flexibly modified logics.

Ultimately unlimited capabilities for scaling, solution—specific adjustments, re-distribution of resources with changes in the number or quality of tasks in monitoring guarded locations and operating various equipment.

2 Installing security system components

An *Axxon PSIM™*-based security system consists of hardware kit that fit the functionality of the basic software kit. This section outlines the procedures for configuring basic hardware components of the security system.

2.1 Assembly and installation of video surveillance subsystem hardware

The video surveillance subsystem of the *Axxon PSIM™* software can include the following hardware components:

1. FS/WS/FX/VRC video capture cards and analogue video cameras connected to them. Information on how to install video capture cards is given in the following chapter.
2. Network video cameras and network video servers connected to the Server via the TCP/IP telecommunication protocols. Installation and configuration procedures for this hardware are outlined in the documentation supplied with the network device.
3. Expansion cards for analogue video signal output that are installed in the video capture cards in order to transmit a video signal to analogue monitors.

2.1.1 Installing video capture cards into computer case

One or more video capture card is included into the kit of *Axxon PSIM™*-based digital video surveillance system.

FS-5B, FS-6B, FS-6C, FS-8, WS-7, SC200Q4 (FS15), SC200Q4 Low profile (FS115), SC230N4 and DS4016HCI video capture cards are connected to the PCI interface version 2.1 and higher; FS-16, SC390N16 (WS16), SC3B0N16 (WS216), WS-17, SC300D16 (FX8), SC300Q16 (FX4), SL16-200 (FX116), VRC6004, VRC6008, VRC7008L, SC590N4, SC330D16 (analogue of SC300D16), SC330Q16 (analogue of SC300Q16) and SC3C0N8-L video capture cards are connected to the PCI-express (PCI-E X1) interface; FX416, MS416, SC310N16 (FX16), SC510N4 (FX HD4), VRC6416 and VRC6404HD video capture cards are connected to the PCI-express (PCI-E X4) interface. Installation procedure of video capture cards resembles the installation procedure of standard PCI or PCI-express (sound, network, etc.) cards.

Note

Standard precautions should be observed while installing the video capture cards into a computer case.

Install video capture cards as follows:

1. Turn the computer off and *disconnect* the *plug* from the mains.
2. Remove the computer case cover.



3. Install the video capture card in a free PCI-E X1 slot of the motherboard. Secure the video capture card with a screw.

Note

Before encasing video capture cards, make sure that your hands are free from static electricity, which can damage computer cards and video capture cards. To prevent damage to the cards, various special antistatic tools may be used (for instance, an antistatic wristband).



Example of FS-6C video capture card installation into a PCI slot.



Example of FS-16 video capture card installation into a PCI-E X1 slot.

4. Set the computer case cover.



5. Connect the interface cable with the numbered BNC-pins to the video capture card.



6. Connect video cameras to the interface cable.



7. Connect the power cord of the computer case to the mains and turn the computer on.
8. While the operating system is loading, new hardware (video capture card) is found and the monitor displays the **Found New Hardware Wizard** dialog box.

If *Axxon PSIM™* is to be installed on the given computer, then click the **Cancel** button in the **Found New Hardware Wizard** dialog box. In this case, the driver of the video capture card is installed automatically during the *Axxon PSIM™* software installation.

If *Axxon PSIM™* has already been installed and a new video capture card needs to be installed, then install the driver of the video capture card(s) using the **Found New Hardware Wizard** application (see [Installing drivers for video capture cards](#) section).

Installation of video capture cards is completed.

2.1.2 Installing drivers for video capture cards

When the video capture card is installed in the computer, the monitor displays the **Found New Hardware** message while the operating system is loading.



As a result the monitor automatically displays the **Found New Hardware Wizard** dialog box.



Note

If *Axxon PSIM™* is to be installed on the given computer, then click the **Cancel** button in the **Found New Hardware Wizard** dialog box. In this case, the driver of the video capture card is installed automatically during the *Axxon PSIM™* software installation.

If *Axxon PSIM™* has already been installed and a new video capture card needs to be installed or a driver needs to be reinstalled, do the following:

Attention!

It is recommended to shutdown antivirus software while installing the driver

1. Select **No, not this time** and click **Next** in the **Found New Hardware Wizard** dialog box.
2. Select one of the following actions:
 - a. Install the software automatically (recommended) – driver search and follow-up installation.
 - b. Install from a list or specific location – enables selecting the necessary driver or a folder for manual driver search.

If the **Install the software automatically (recommended)** item is selected, then the description of installation continues with item 6.

3. Select **Install from a list or specific location** and click **Next**.

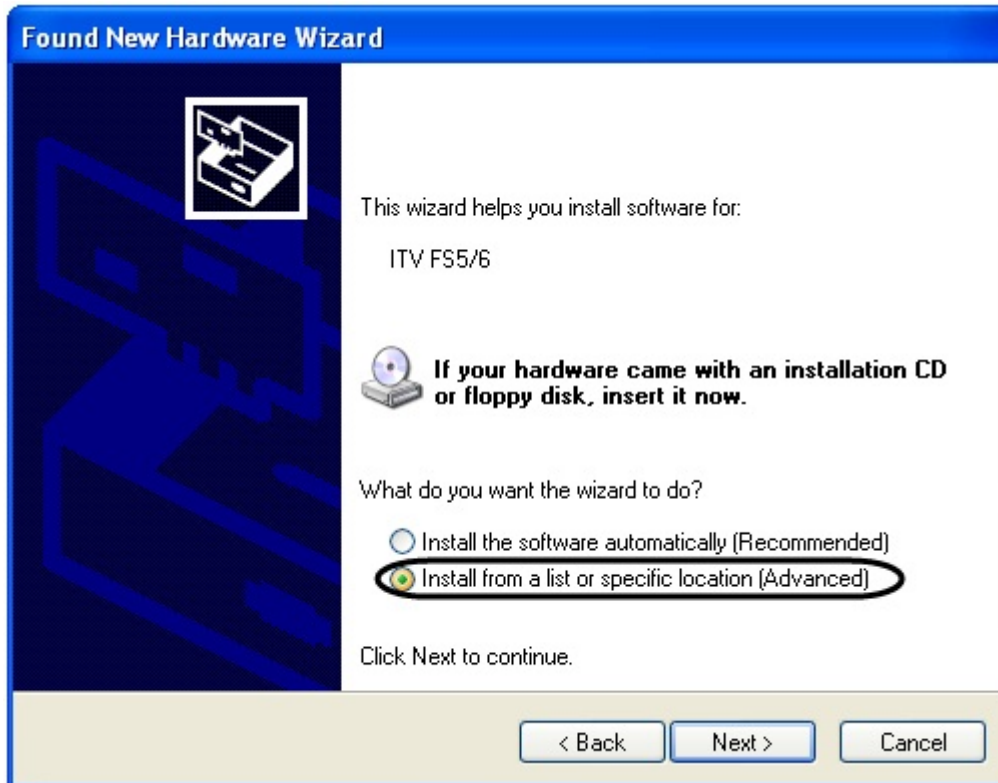

4. Set the **Include this location in the search** checkbox in the search options dialog box and click the **Browse** button. In the **Browse For Folders** box specify the path to the folder that contains drivers for a video capture card and click **OK**.

Note

Drivers for SC3C0N8-L video capture card should be downloaded from the manufacturer's web site: <https://www.yuan.com.tw/support/download.htm> (or follow the [link](#)). Drivers for all the rest of the video capture cards are stored in the **Drivers** folder in the installation kit or in the *Axxon PSIM™* software installation directory. To install drivers for video capture cards select the folder, where the drivers for video capture cards are stored (see [Drivers for video capture cards integrated into the Axxon PSIM™ software](#) section).

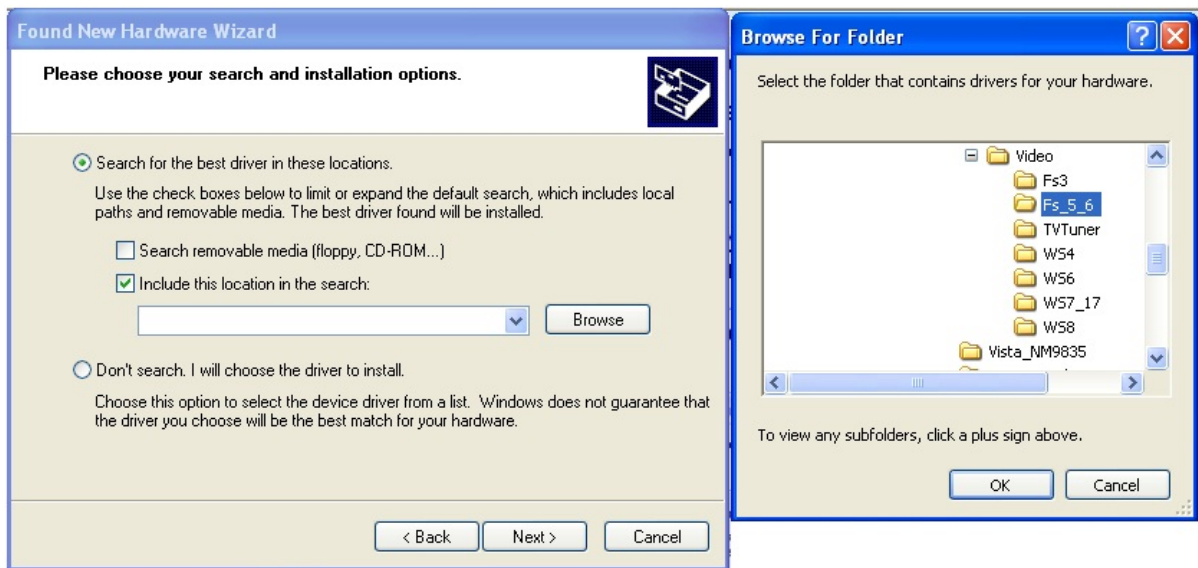

5. After specifying the path to the folder click the **Next** button in order to start installation process.

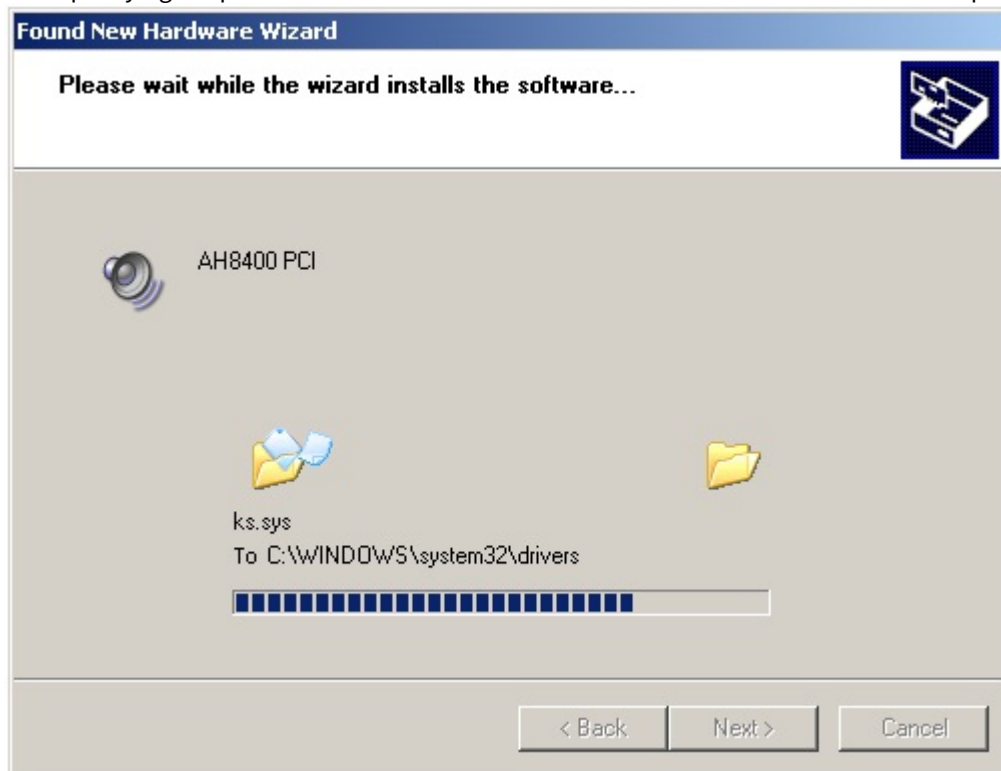

6. Ignore Microsoft notification by clicking the **Continue Anyway** button.



7. To complete installation click the Finish button.



As a result, the message **Your new hardware is installed and ready to use** is displayed in the Windows taskbar.

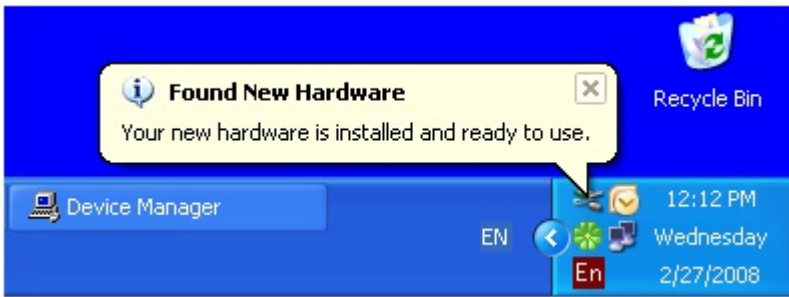

Installation of a driver for video capture card is completed.

Driver installation procedure for one video capture card is repeated in turn required number of times depending on the number of ADCs on the video capture card (e.g., 1 time for FS-5 video capture card, 4 times for FS-6, FS-16, WS-7 video capture cards, 8 times for FS-8 video capture card).

2.1.3 Testing installation of drivers for video capture cards

When installation of the drivers for video capture cards is finished, driver availability in the Windows operating system should be tested with the help of the **Device Manager**. For this, do the following:

1. Open the **System Properties** window by right-clicking the **My Computer** icon on the desktop and select **Properties** in the contextual menu.

Note

The **System Properties** window can be opened by clicking **Start=> Control Panel=> System**.



2. In the **System properties** dialog box, go to the **Hardware** tab and click the **Device Manager** button.

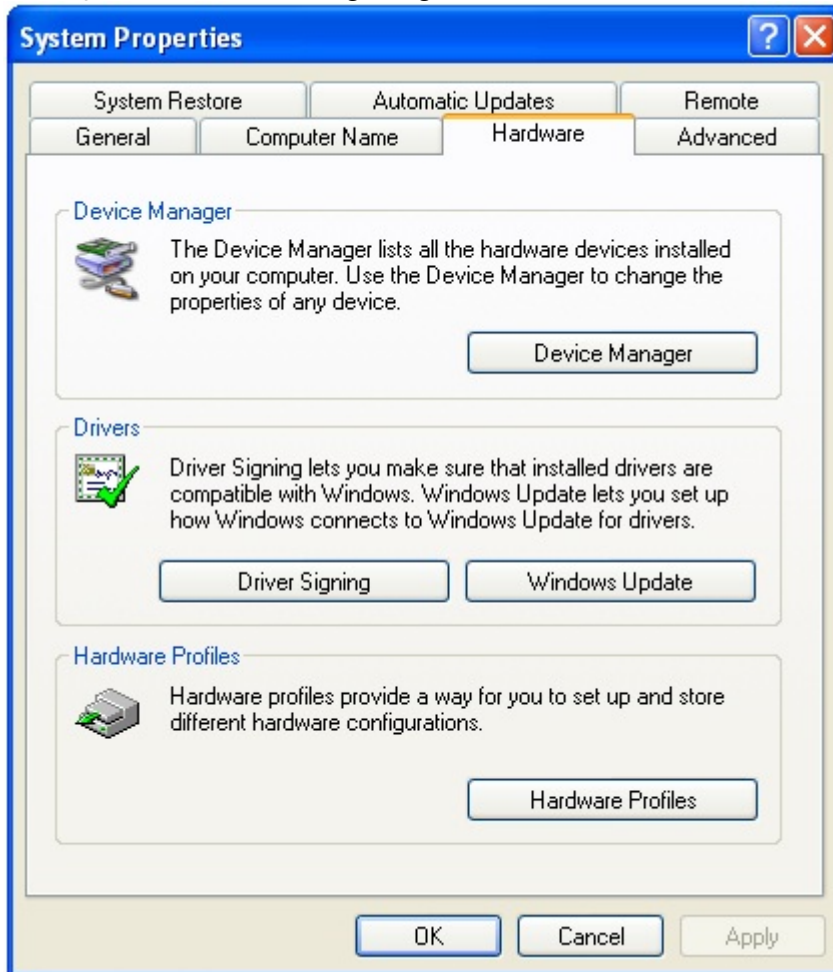

- Go to **Sound, video and game controllers** item in the Windows hardware tree and check if the displayed list of devices agrees with the types of installed video capture cards.

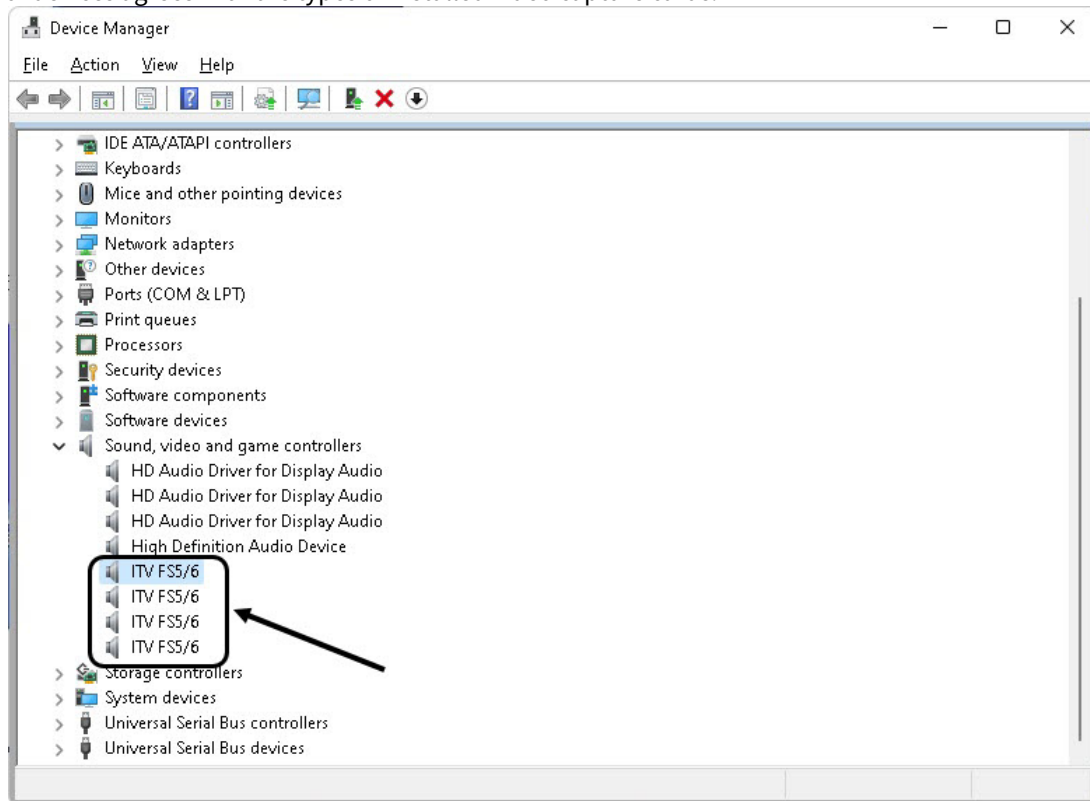

Important!

If Secure Boot is enabled in BIOS, then the video capture cards' drivers with no Microsoft digital signature won't start on Windows 10 since build 1607 and later, and the corresponding devices will be with the exclamation mark on the yellow background in the list. In this case restart the computer and disable Secure Boot in BIOS. If Secure Boot is still necessary, install older Windows 10 version (build before 1607), then install video capture card drivers, then update to a newer Windows 10.

2.1.4 Testing installation of drivers for video capture cards using the Codereader.exe utility

To test installation of drivers for video capture cards use the Codereader.exe utility designed to read the codes of video capture cards. It is bundled with the *Axxon PSIM™* software.

Note

Some video capture cards (e.g., SL16-200 (FX116), FX416 and MS416) are not equipped with a cryptochip. It is impossible to test installation of drivers for these video capture cards using the Codereader.exe utility.

The utility is run from the **Tools** folder of the *Axxon PSIM™* software installation package. E.g., C:\Program Files\Axxon PSIM\Tools\codereader.exe.

The Codereader.exe utility can also be run by selecting **Start** → **All Programs** → **Axxon PSIM** → **Utilities** → **Code Reader**.

As soon as the utility is run, the monitor displays a window with the codes of video capture cards.

If the drivers for video capture cards are installed correctly, the utility window will display the codes of video capture cards. If there are several embedded ADCs in the video capture card, then the codes will be repeated as many times as there are ADCs in the video capture card.

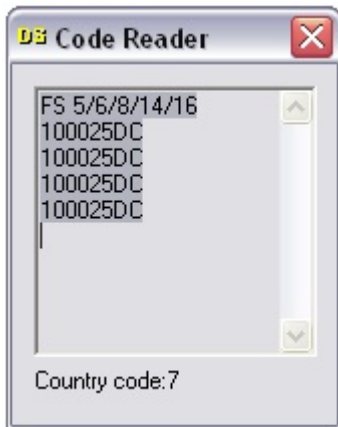

If the Codereader.exe window does not display any code or displays it as “0000”, it means that:

1. A video capture card is not installed in the computer.
2. A video capture card is defective.
3. A driver for a video capture card is not installed.
4. Installed driver does not correspond to a video capture card in use.
5. Installed driver for a video capture card fails to perform.
6. A video capture card has no cryptochip (SL16-200 (FX116)/FX416/MS416).

Check if the video capture card is installed in the computer and re-install drivers for all ADCs of the video capture card. If after re-installation ADC codes still cannot be read by the Codereader.exe utility, then contact your distributor to check the video capture card.

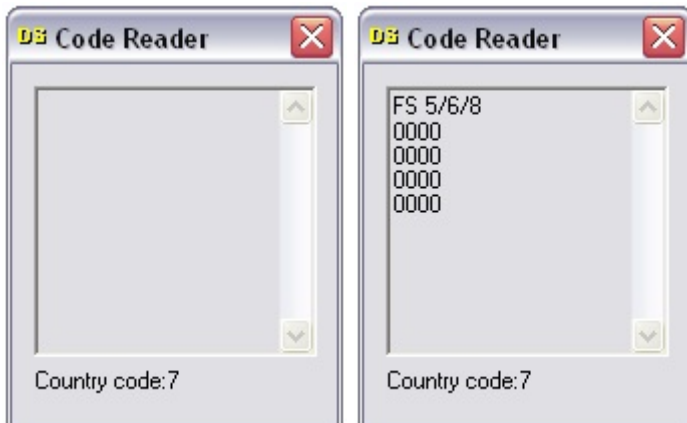

2.1.5 Special features of Driver Pack updating for YUAN cards

The following video capture devices are qualified as YUAN cards: SC390N16 (WS16), SC3B0N16 (WS216), SC200Q4 (FS15), SC300Q16 (FX4), SC300D16 (FX8), SC310N16 (FX16), SC200Q4 Low profile (FS115), SC510N4 (FX HD4), SC330Q16 (analogue of SC300Q16), SC330D16 (analogue of SC300D16) and SC3C0N8-L.

For these cards updating from DriversPack 3.2.21 and lower to version 3.2.22 and above is performed as follows:

1. Remove installed DriversPack and install a new version or update the installed Driverspack.
2. Repair the Axxon PSIM software package (see the [Repairing Axxon PSIM™ software](#) section in [Administrator's Guide](#)).

⚠ Attention!

The repairing utility is to be run using the login of computer Administrator.

3. Check whether the drivers for video capture card are installed (see the [Testing installation of drivers for video capture cards](#) section).
4. Install the driver if it was not installed (see the [Installing drivers for video capture cards](#) section).

i Note.

The YUAN card will not be found by the *Camera discovery tool* after performing actions which are described above. In this case, configure video subsystem manually (see the [Video subsystem configuration](#) section).

The card will be found by the *Camera discovery tool* if you install DriversPack and then install the *Axxon PSIM* software package.

2.2 Connecting the hardware performance testing

Hardware performance tester is designed to automatically restart the computer whenever any failure in the Windows OS or basic modules of *Axxon PSIM™* software occurs.

Hardware performance testing is done in one of two ways:

1. With the help of Watchdog used on servers with installed video capture cards that support the Watchdog hardware testing (see [Appendix 3. Technical specifications of video capture cards](#)).
2. With the help of USB-Watchdog used on servers and clients without installed video capture cards.

2.2.1 Connecting the Watchdog hardware performance tester

In case of the Watchdog hardware performance testing the **Reset** button is connected to the computer motherboard via the video capture card with the help of special Watchdog cable.

i Note

The Watchdog cable is optionally bundled with video capture card.

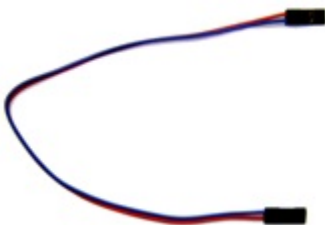

If several video capture cards are installed on the Server, then Watchdog is connected to one card only.

A special four-pin connector or two two-pin connectors are installed on the video capture card to connect the Watchdog cable.

A four-pin connector for connecting the hardware tester of Watchdog pending (by the example of FS-5 video capture card):

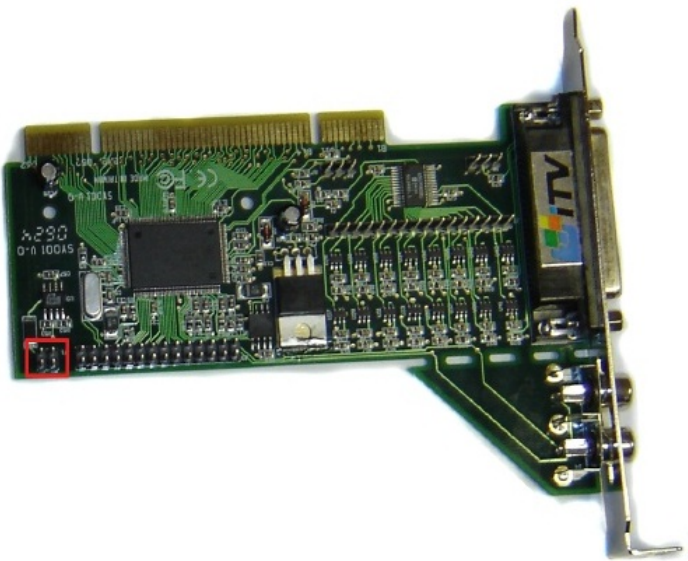

Two two-pin connectors for connecting the hardware tester of Watchdog pending (by the example of SC300Q16 (FX-4) video capture card):

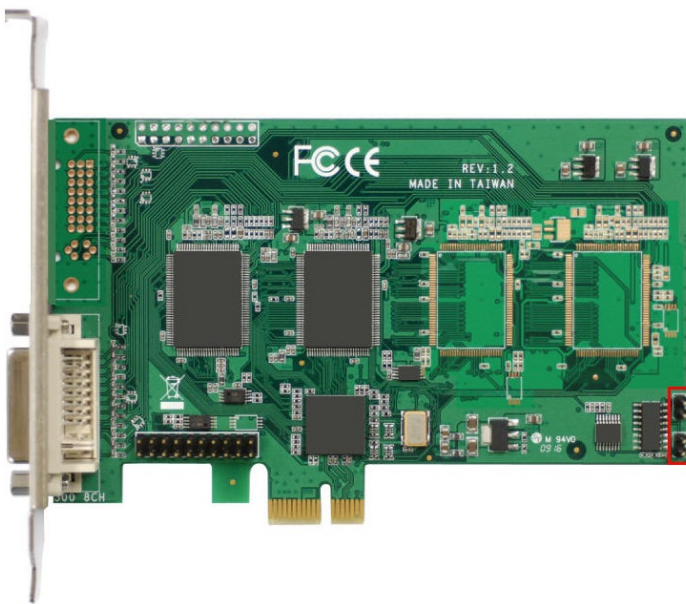

Connect the Watchdog hardware performance tester as follows:

1. Make sure that power of motherboard and video capture card is off.
2. Connect the cable of the **Reset** button to the two-pin or four-pin connector of video capture card with the help of a pair of 1/0 or 2/0 connections. Connection of the Reset button cable to FS-5 video capture card is displayed in the second figure.

⚠ Attention!

Cables are to be connected to the video capture card taking into account the positioning of the main wire of four-pin connector. You can connect the Watchdog cable to two-pin connector of FX video capture cards any way without taking into account the positioning of the main wire.

Note

To specify the positioning of the main wire (earth conditioned «-/-») the multimeter may be used in the resistance test mode. In this case the main wire is determined by 0 resistance value between contacts.

Appearance and pinout of four-pin connector of video capture card: 0/0-main wire (earth conditioned «-/-»), 1/0 and 2/0- pairs of contacts for cables connections («+/-», «+/-»):

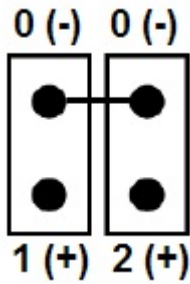

The **Reset** button cable connection to the four-pin connector of FS-5 video capture card:

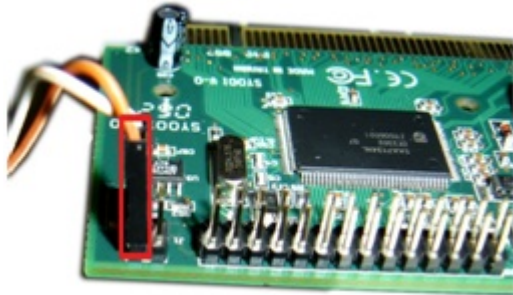

3. Connect the Watchdog cable to the vacant two-pin or four-pin connector of video capture card with the help of vacant pair of contacts (1/0 or 2/0) – see the figure above. The Watchdog cable connection to FS-5 video capture card is exemplified in the figure below:



4. Connect the vacant end of the Watchdog cable to the connector on the motherboard for the **Reset** button cable.

Connecting the Watchdog hardware performance tester is completed.

Note

Connecting the Watchdog hardware performance tester is not correct if there is no reboot after pressing the **Reset** button.

If all the steps of connecting are correct, then the Watchdog inoperativeness can be caused by inobservance of polarity while connecting the Watchdog cable to the motherboard. Interchange the cables and reconnect the Watchdog cable to the motherboard.

Note

Program setting of the Watchdog function is necessary to activate the hardware performance tester (see [Configuring the Watchdog hardware performance tester](#) section).

2.2.2 Connecting the USB Watchdog hardware performance tester

In case of the USB Watchdog hardware performance testing the **Reset** button is connected to the computer motherboard via the USB Watchdog device with the help of special Watchdog cable. The appearance of the USB Watchdog device is displayed in the figure:

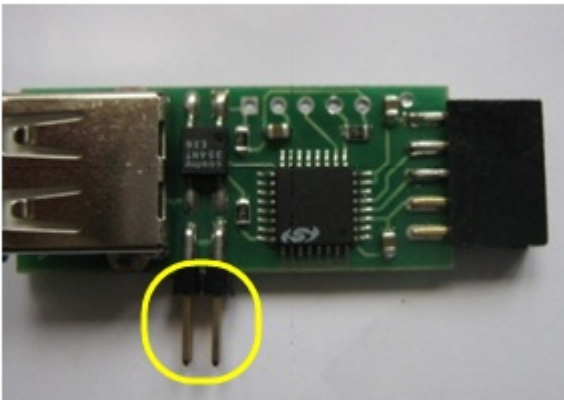

Special four-pin connector is installed on the USB Watchdog device to connect the Watchdog cable.

Connect the USB Watchdog hardware performance tester as follows:

1. Make sure that power of motherboard and video capture card is off.
2. Connect the USB Watchdog device to USB connector on the motherboard.

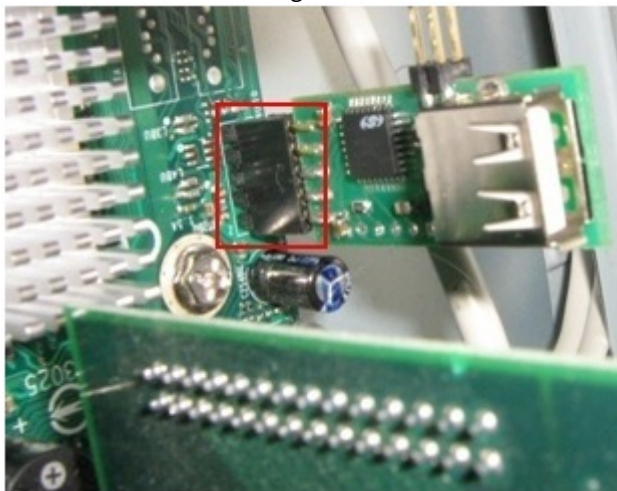

3. Connect the **Reset** button cable to the four-pin connector of the USB Watchdog device with the help of a pair of contacts (1/0 or 2/0). Connecting the **Reset** button cable to the USB Watchdog device is exemplified in the figure.

⚠ Attention!

Cables are to be connected to the video capture card taking into account the positioning of the main wire of four-pin connector.

📘 Note

To specify the positioning of the main wire (earth conditioned «-/-») the multimeter may be used in the resistance test mode. In this case the main wire is determined by 0 resistance value between contacts

Appearance and pinout of four-pin connector of the USB Watchdog: 0/0-main wire (earth conditioned «-/-»), 1/0 and 2/0- pairs of contacts for cables connections («+/-», «+/-»):

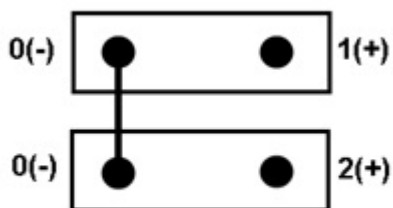

Connection of the cables to four-pin connector of the USB Watchdog device.



4. Connect the Watchdog cable to four-pin connector of the USB Watchdog device with the help of a vacant pair of contacts (1/0, or 2/0) – see the figure above.

5. Connect the vacant end of the Watchdog cable to the connector on the motherboard for the **Reset** button cable.

Connecting the USB Watchdog hardware performance tester is completed.

⚠ Attention!

The USB Watchdog hardware performance tester is activated with the help of the System restart service (see [Activating the hardware control of workability](#) section in [Administrator's Guide](#)).

i Note

Connecting the USB Watchdog hardware performance tester is not correct if there is no reboot after pressing the **Reset** button.
If all the steps of connecting are correct, then the USB Watchdog inoperativeness can be caused by inobservance of polarity while connecting the Watchdog cable to the motherboard. Interchange the cables and reconnect the Watchdog cable to the mother board.

i Note

USB connector on the USB Watchdog may be used for connecting any external USB devices to the computer. Connected USB devices do not influence the USB Watchdog hardware performance tester.

2.3 Connecting Sensor-Relay cards

DI/DO card is connected to the video capture card and is used for connecting guard loops (sensors), relays and in some cases analog sensors to the control system - the server with installed *Axxon PSIM™* software. General information about sensors and relays is given in the table:

Type of device	Description	Functions	Operation conditions	Changes in operation condition	Examples of devices
Sensor	Interface line of external sensor and control system	Informs the control system about changes in sensor status	Closed – logical one Open – logical zero	Opening/ closing – when sensor detects the alarm	Annunciators (smoke, heat, window, etc), button
Relay	Interface line of control system and executive device	Changes operation condition of executive device on command from the control system	Closed – logical one Open – logical zero	Opening/ closing – on command from the control system.	Annunciators (light, sound, etc.), mechanized gates

Type of device	Description	Functions	Operation conditions	Changes in operation condition	Examples of devices
Analog sensor	Interface line of external sensor and control system	Informs the control system about changes in sensor status	-	In analog (continuous) mode.	Temperature, humidity, pressure, etc. sensors

Electrical and technical specifications of some Sensor-Relay cards are given in [Appendix 5. Electrical and technical specifications of Sensor-Relay cards](#) section. For the most up-to-date information on the characteristics and connection of the Sensor-Relay cards, please see the manufacturer's documentation. Some of the Sensor-Relay cards are integrated with Axxon PSIM via Drivers Pack. See [Drivers Pack documentation](#) for the full list of such cards.

2.3.1 Connecting 4/4 and 16/4 Sensor-Relay cards

Multichannel digital-to-analogue conversion 4/4 and 16/4 Sensor-Relay cards can be installed on the Server depending on the security system requirements:

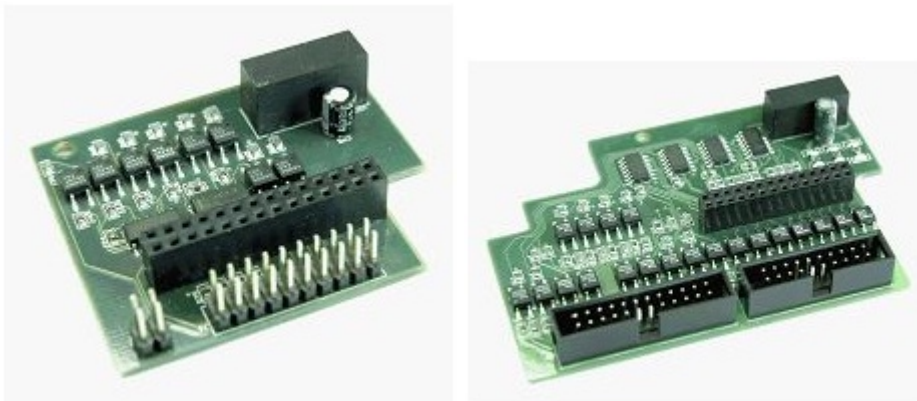

The 4/4 Sensor-Relay cards enable to process the signals from 4 sensors and the 16/4 cards - from 16 sensors. Simultaneously with processing the sensors signals these cards perform digital-analogue conversion and transmit up to 4 control signals to executive devices (relays).

The 4/4 and 16/4 Sensor-Relay cards have power (24V) and grounding terminals. The 4/4 and 16/4 Sensor-Relay cards are installed in the J9 connector on FS-5, FS-6, FS-16 and FS-8 video capture cards (see [Appendix 4. Video capture cards pins](#)).

Connect Sensor-Relay cards as follows:

1. Make sure that power supply of the video capture card is off.
2. Install the Sensor-Relay card on the video capture card in the J9 connector.

Connector on the Sensor-Relay card for connecting to the video capture card (by the example of 4/4 and 16/4 Sensor-Relay cards):

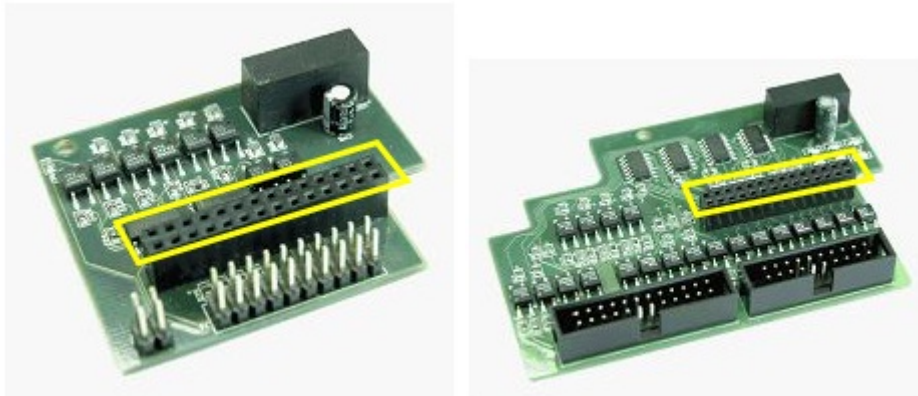

Connector J9 on the video capture card for connecting the Sensor-Relay card (by the example of FS6 video capture card):



Installation of the Sensor-Relay card on the video capture card (by the example of 4/4 and 16/4 Sensor-Relay cards and FS6 video capture card):

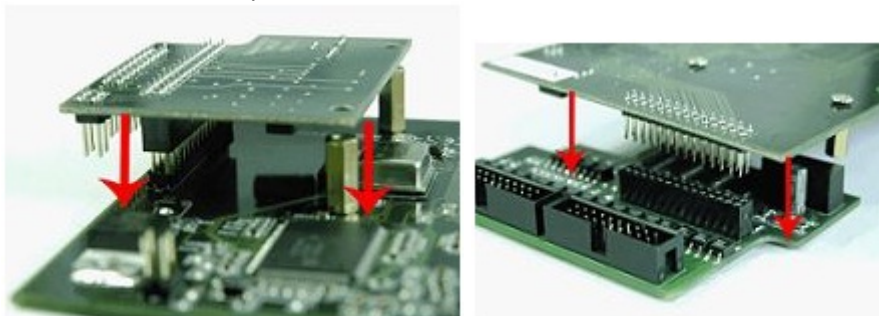

3. Fix the Sensor-Relay card on the video capture card with the help of screws bundled with the distribution kit of the Sensor-Relay card.
4. Connect the interface cable (bundled with the distribution kit of the Sensor-Relay card) to the Sensor-Relay card with the help of special connector:

Note

For interface cable connection the 4/4 Sensor-Relay card has J6 connector, 16/4 Sensor-Relay card has J6 and J7 connectors.

Attention!

The first wire of the interface cable (marked red) is to match the first pin of corresponding connector of the Sensor-Relay card.

Sensor-Relay interface cable:

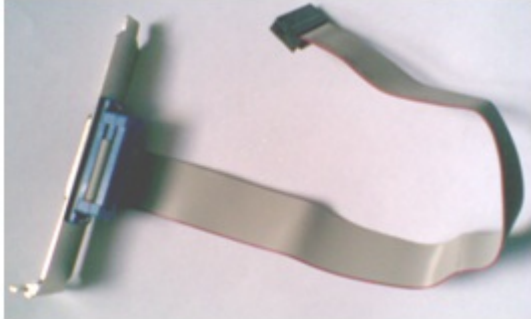

Connectors on the Sensor-Relay card for the interface cable connection (by the example of 4/4 and 16/4 Sensor-Relay cards):

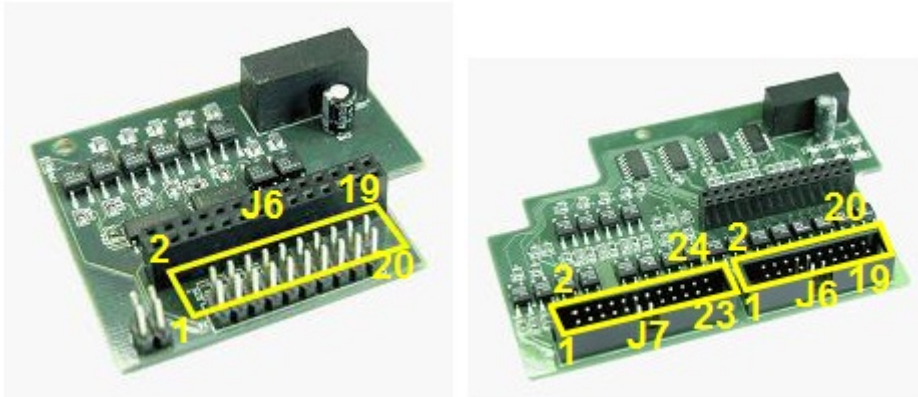

J6 and J7 connector pinout:

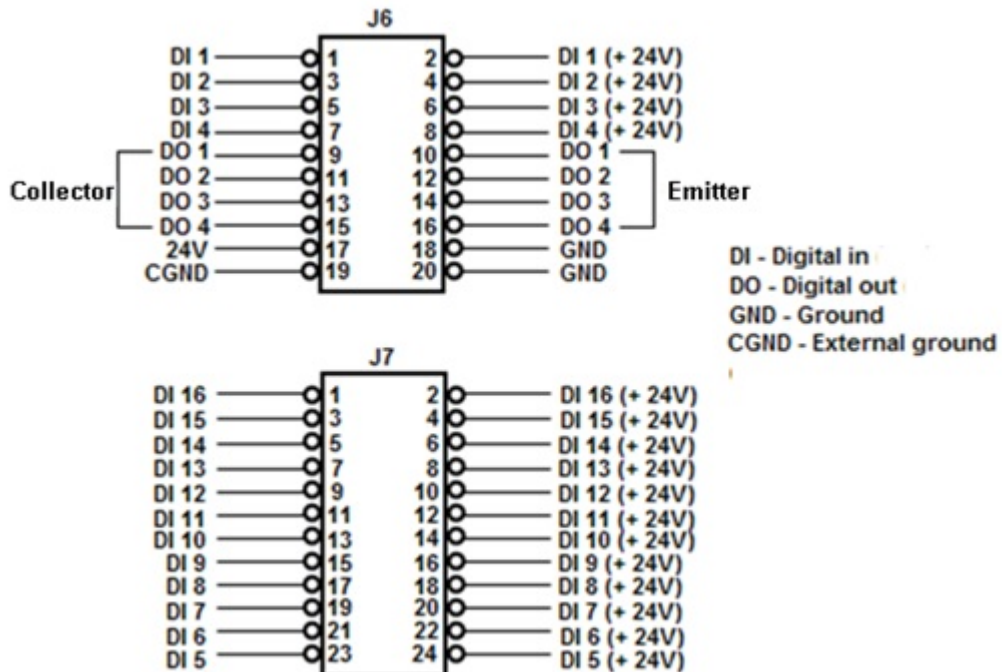

Example of the interface cable connection to the 4/4 Sensor-Relay card:



- To connect Sensor-Relay, unsolder the connector bundled with the distribution kit of the Sensor-Relay card. Unsoldering is made in accordance with the external connector pinout of the Sensor-Relay interface cable, taking into account power circuit of connected devices.
External connector pinout of the Sensor-Relay interface cable:

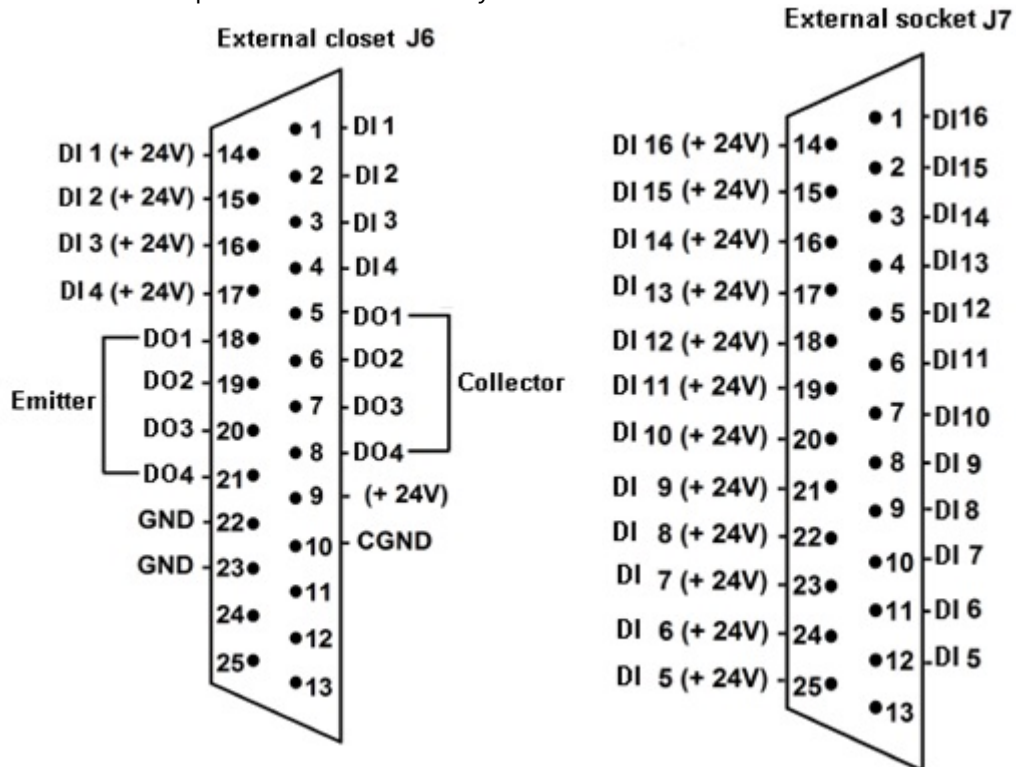

Sensor types and features of their connection:

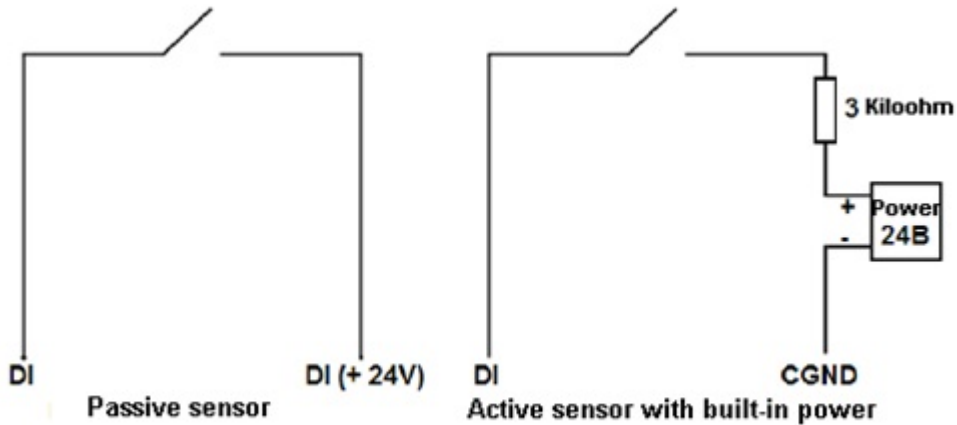

Example of power relay connection (with external power supply):

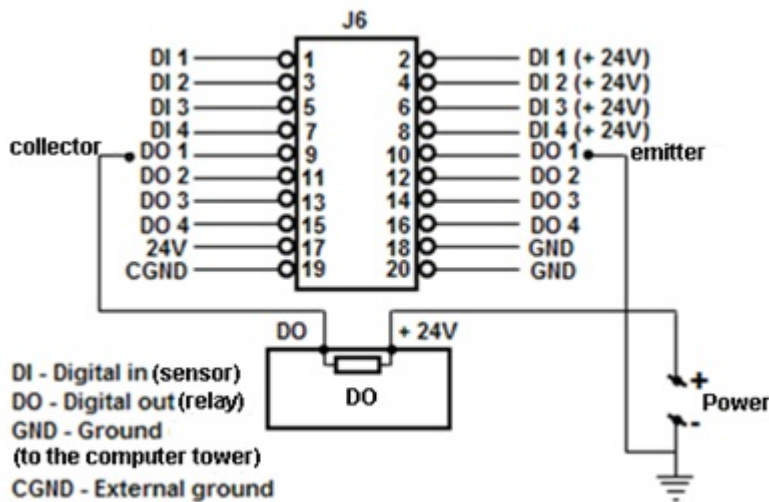

Example of low-power relay (power supply on the card):

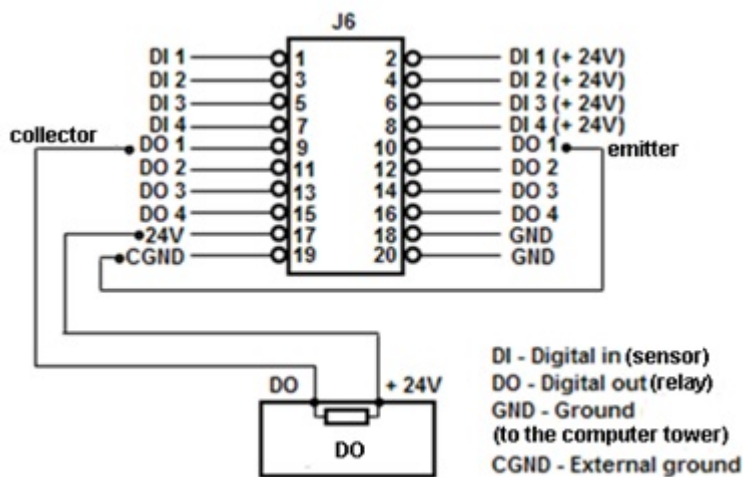

- Fix the unsoldered connector in the casing bundled with the distribution kit of the Sensor-Relay card.

7. Connect ready-for-use connector to external connector of the Sensor-Relay interface cable in order to connect Sensor-Relay to the Server.

The Sensor-Relay cards are now connected.

2.3.2 Connecting 4/4 Sensor-Relay (low profile) cards

Building security video subsystem with the use of SC200Q4 Low profile (FS115) / SC300Q16 (FX4) / SC300D16 (FX8) / SC310N16 (FX16) / SC230N4 / SC3B0N16 (WS216) / SC590N4 video capture cards one can install 4/4 Sensor-Relay cards (low profile) in order to connect external sensors (DI) and executive devices (DO) to the Server.

4/4 Sensor-Relay (low profile) card appearance is shown in the figure:

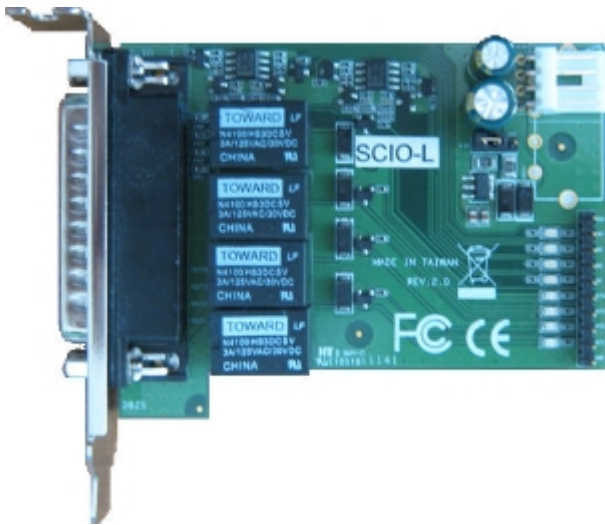

Connect the 4/4 Sensor-Relay (low profile) card as follows:

1. Make sure that the power of computer is off.
2. Connect the 4/4 Sensor-Relay (low profile) card to the video capture card with the help of loop bundled with the distribution kit. The loop is connected to J2 and J3 connectors (see the figures below and [Appendix 5. Video capture cards pins section](#)).

Note

The loop is to be connected to the first row of J2 connectors. One of the outers is marked red in the figures.

The 4/4 Sensor-Relay card (low profile) can be connected to SC590N4 video capture card both to the first and the second row of J2 connectors.

The figure showing the 4/4 Sensor-Relay (low profile) card connection to SC200Q4 Low profile (FS115) card:

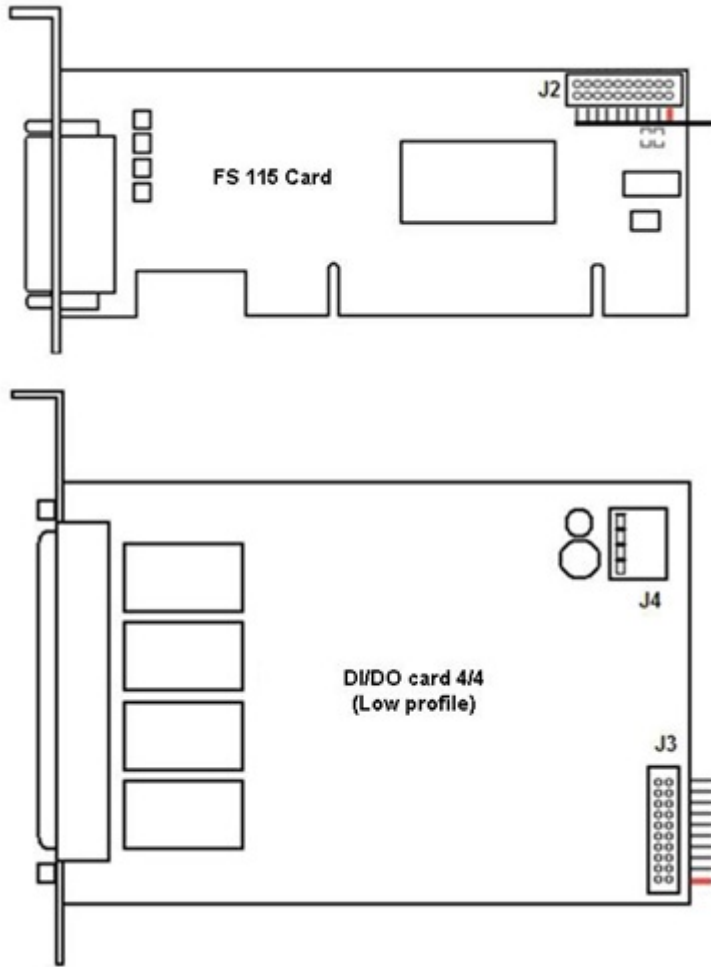

The figure showing the 4/4 Sensor-Relay (low profile) card connection to SC330Q16, SC300Q16/SC300D16/ SC310N16 (FX4/8/16) cards:

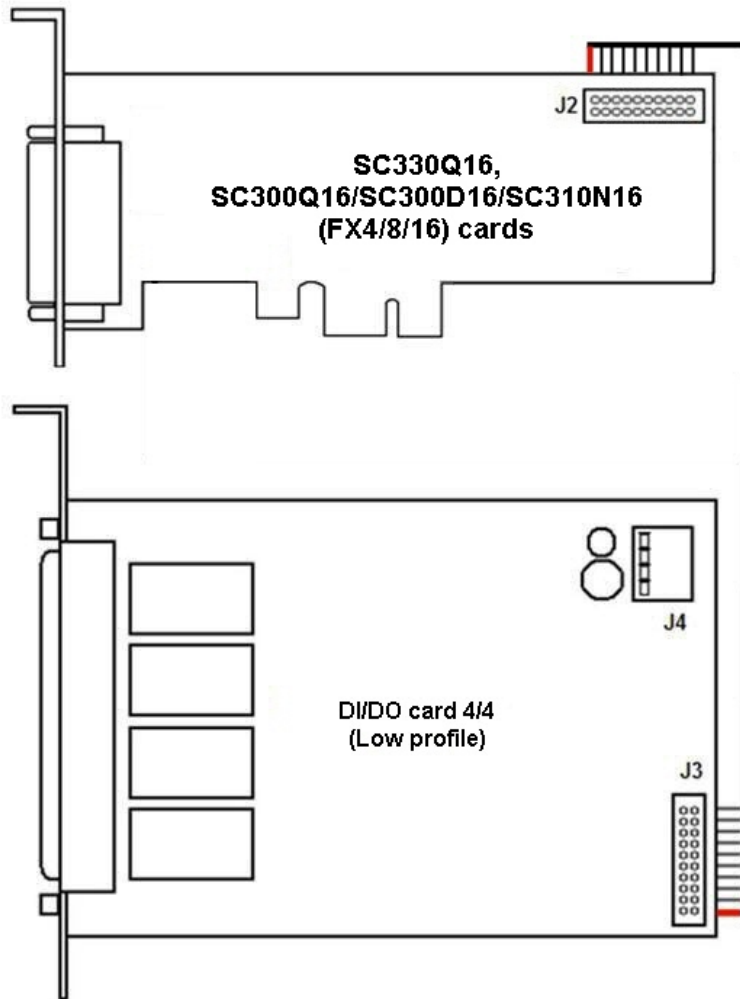

The figure showing the 4/4 Sensor-Relay (low profile) card connection to SC3B0N16 (WS216) card:

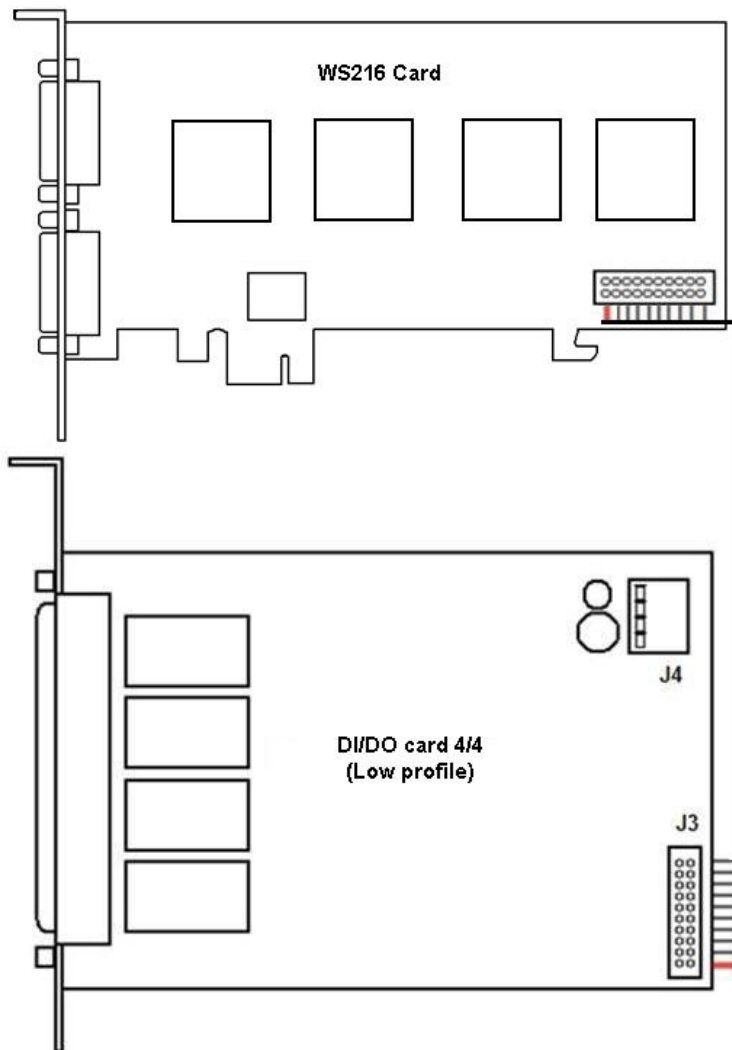

The figure showing the 4/4 Sensor-Relay (low profile) card connection to SC590N4 card:

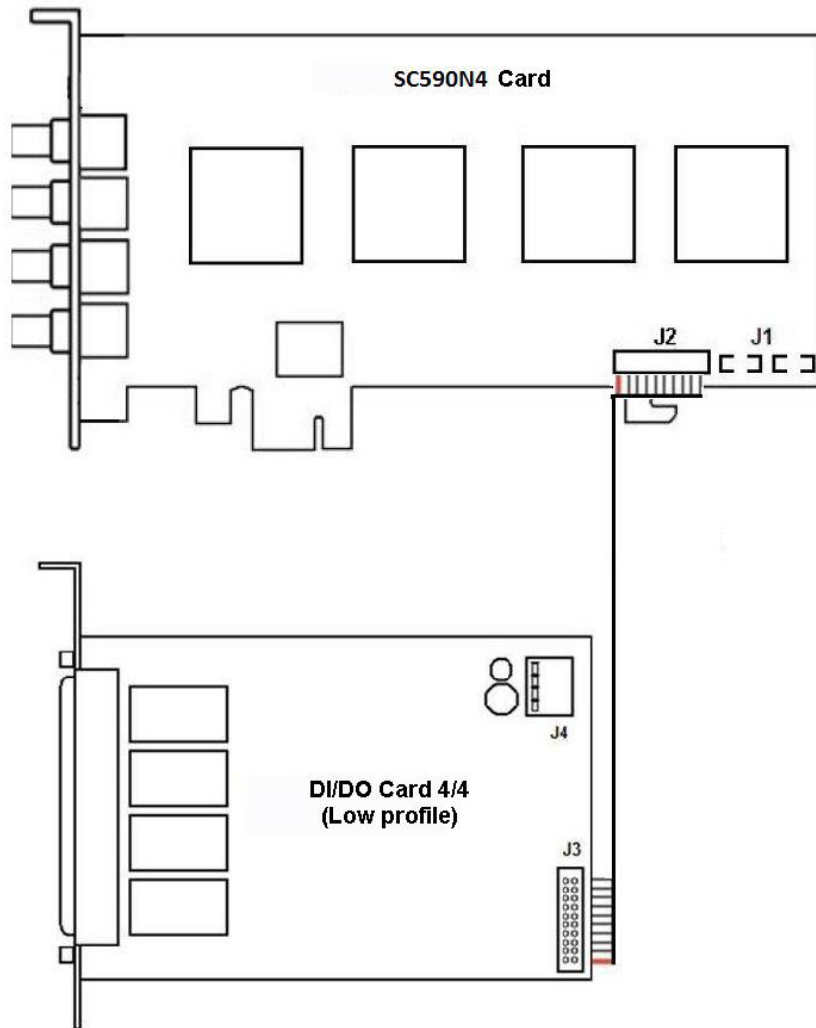

Note.

SC590N4 card supports up to 8 sensors and 8 relays as two 4/4 Sensor-Relay (low profile) cards can be connected to the J2 connector simultaneously.

The figure showing the 4/4 Sensor-Relay (low profile) card connection to SC230N4 card:

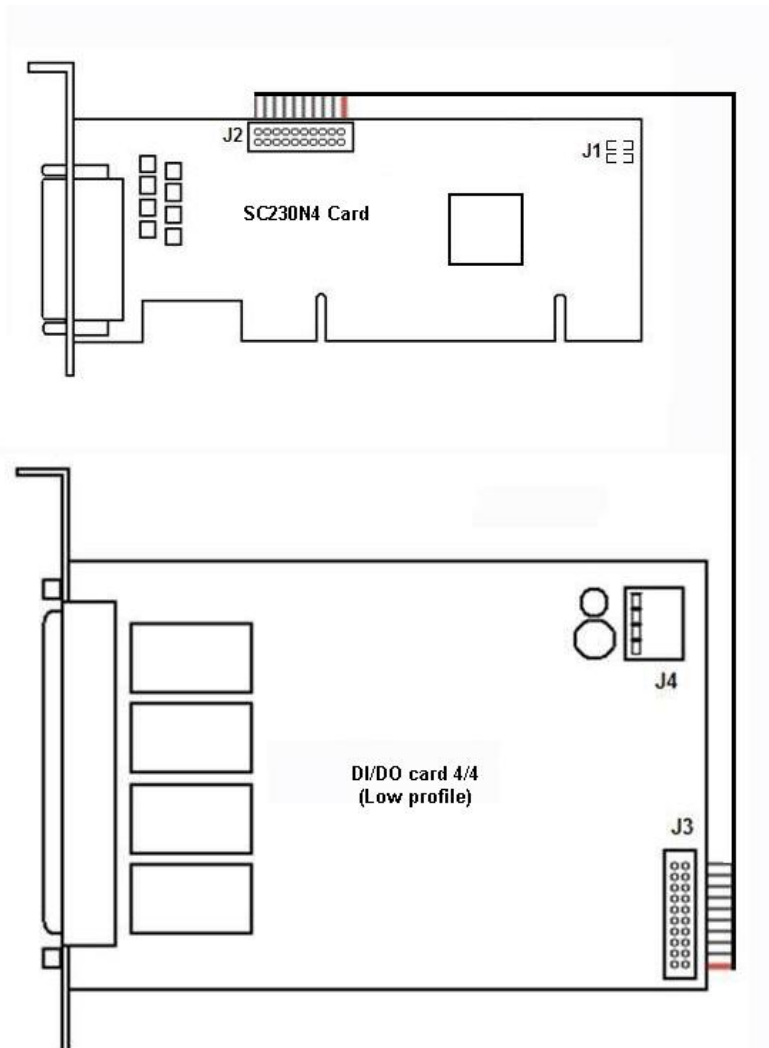

3. Connect the cable of computer PSU (disk drive power supply) to J4 connector of the 4/4 Sensor-Relay (low profile) card.
4. Install the card into vacant computer slot and fix it in the casing with the help of screw.

- To connect Sensor-Relay, unsolder the connector. Unsoldering is made in accordance with the external connector pinout of the 4/4 Sensor-Relay (low profile) card.

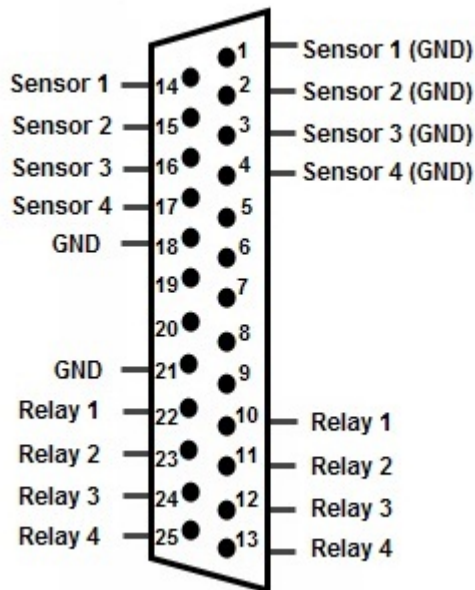

- Connect the ready-for-use connector to external connector of the 4/4 Sensor-Relay (low profile) card in order to connect sensors and relays to the Server.

⚠ Attention!

For 4/4 Sensor-Relay (low profile) card proper operation it is essentially required to supply video signal on at least one channel of the video capture card connected to the 4/4 Sensor-Relay (low profile) card.

The 4/4 Sensor-Relay (low profile) card is now connected.

2.3.3 Connecting SL USBIO cards (4x4, 16x8 and 24x4)

The SL USBIO card is an interface of external sensors and external executive devices (relays) as a part of video surveillance and fire and security alarm systems.

The figures show the appearance of SL USBIO cards:

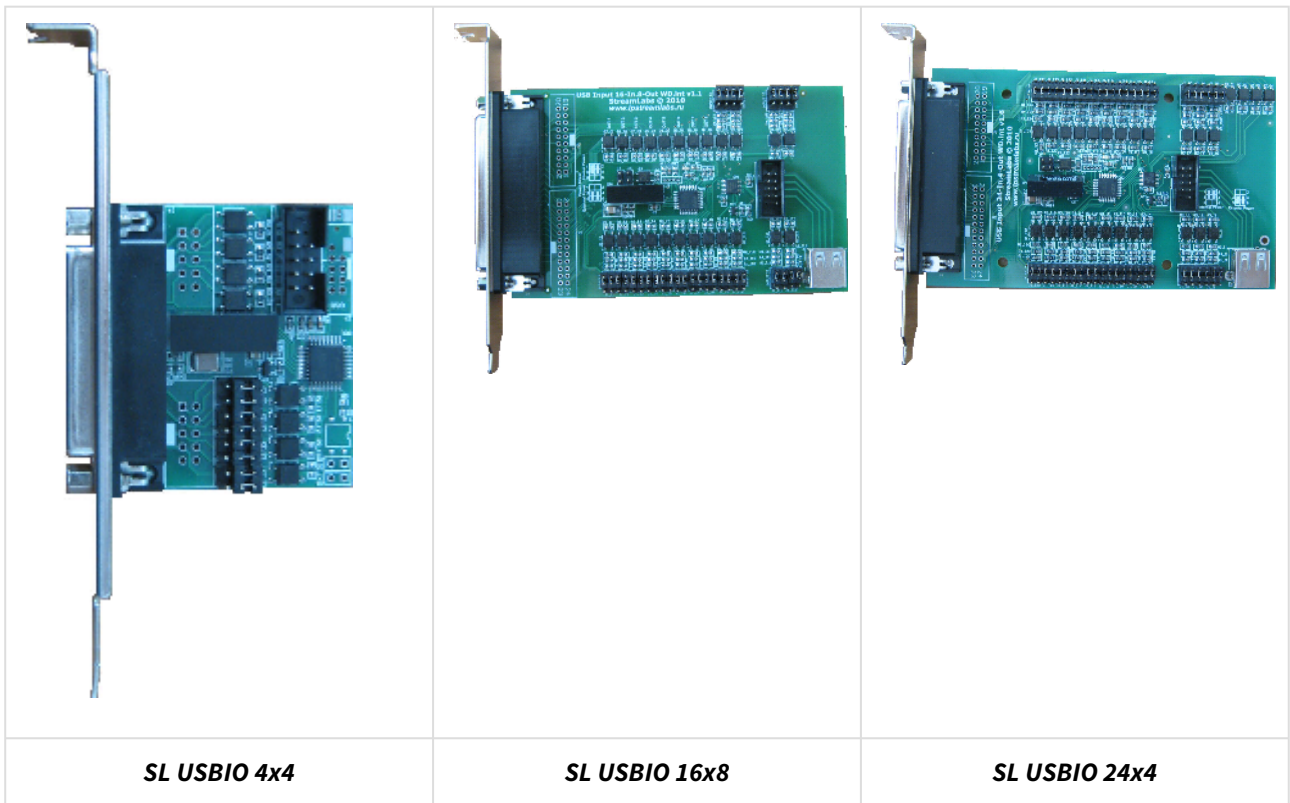

The layout of SL USBIO connectors:

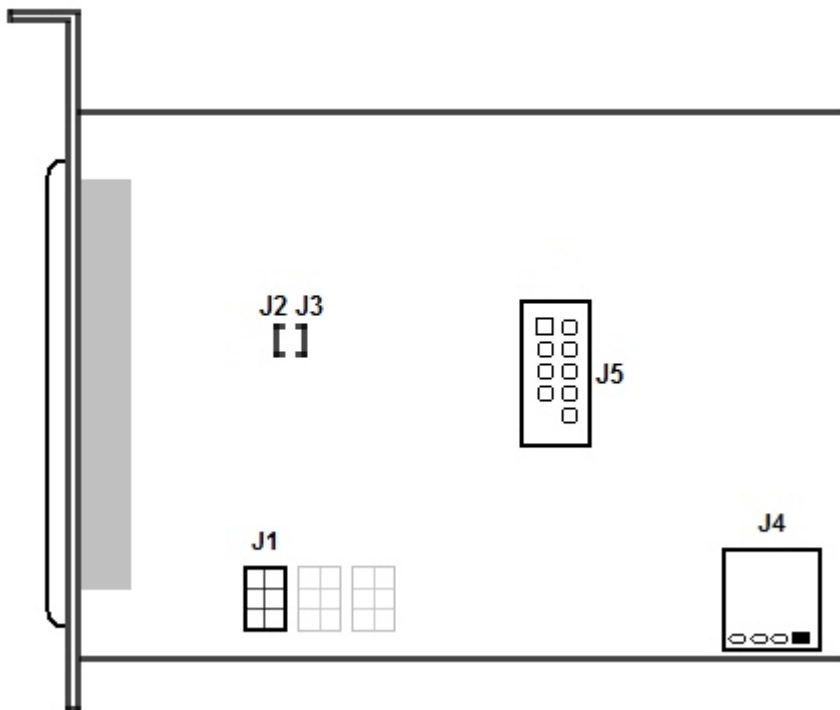

Connect the SL USBIO card to the Server as follows:

1. For each sensor configure the power supply by shifting the jumper in the corresponding **J1** contact set.

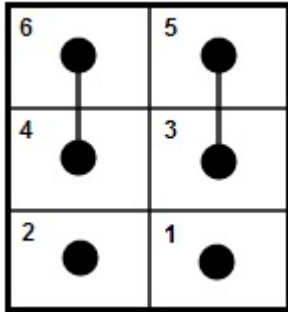

Sensor functions using the power supply in the device

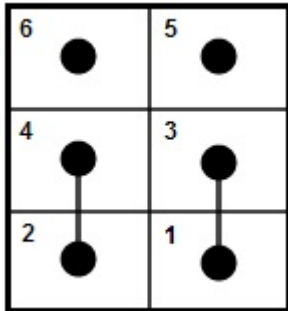

Sensor functions using the external power supply
(polarity of external voltage is not important)

2. Switch the computer power supply off. Remove the system cover.
3. Install the SL USBIO card into a vacant motherboard slot and fix it in the casing.
4. Connect the loop (bundled with the distribution kit) to the **J5** connector and to a vacant USB connector on the motherboard of computer.

Note

There is a special adapter in the delivery package if the SL USBIO 4x4 card is in use and the motherboard has an outsized USB connector or there is no connector for a loop contact. If you do not have the adapter, it is required to acquire one or route the loop leads by yourself taking into account the connector layout on the motherboard and USB connector layout on the SL USBIO 4x4 card (see the figure below):

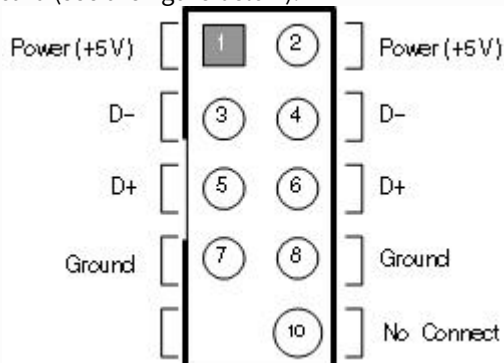

5. To activate the hardware pending check, connect wires to the **J2 J3** connector (see [Connecting the hardware performance testing](#) section).

Note

There is no **J2 J3** connector on the SL USBIO 4x4 card.

Use **J4** port if the connection is to be performed via the external USB port (USB cable of A-A type) or the USB device is to be connected.

Note

There is no **J4** port on the SL USBIO 4x4 card.

6. To connect sensors and relays, unsolder the connector and fix it in the casing bundled with the distribution kit. Unsoldering is made in accordance with the external connector layout (see [Appendix 5. Electrical and technical specifications of Sensor-Relay cards](#)).
7. Connect the ready-for-use connector to external connector of the SL USBIO card.

Note

When connecting a SL USBIO card, the operating system can automatically install drivers for it. If the drivers were not installed immediately after the card connection, they will be installed along with the *Axxon PSIM* installation. The drivers can also be installed manually from the Windows Device Manager – see [Drivers for video capture cards, sensor/relay cards, Guardant and USB Watchdog integrated into Axxon PSIM](#).

After the cards are installed, they have the following names in the device manager:

SL USB IO 4x4	SL USB IO 16x8	SL USB IO 24x4
Stream Labs 4IO	Stream Labs 16I8OWDint	Stream Labs 24I4OWDint

The SL USBIO card is now connected.

2.3.4 Connecting MO USBIO 4x4 cards

The MO USBIO 4x4 card is an interface of external sensors and external executive devices (relays) as a part of video surveillance and fire and security alarm systems.

The figure shows the appearance of MO USBIO card.

Note

This card can be bundled as an external module – see the [Connecting MO USBIO 4x4 external module](#) section

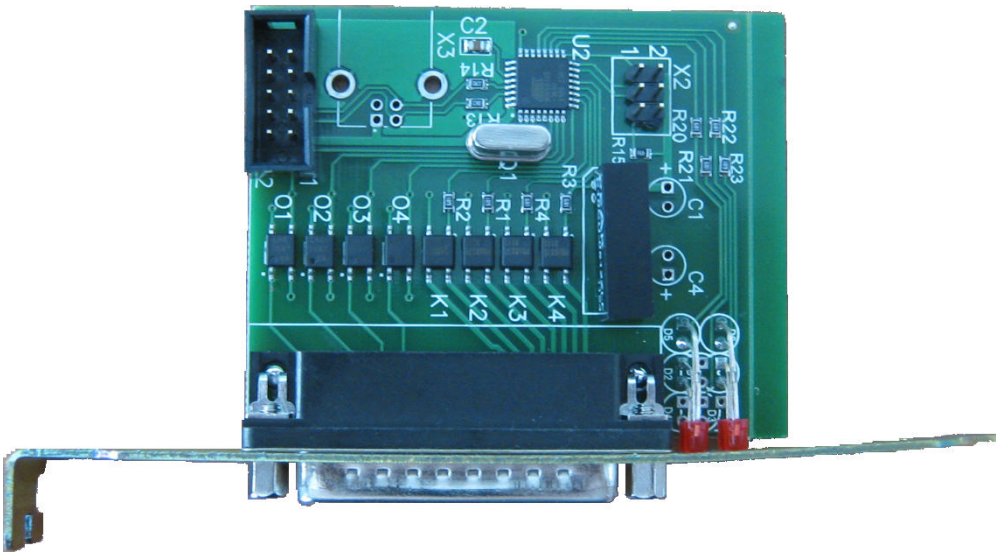

The layout of card connectors:

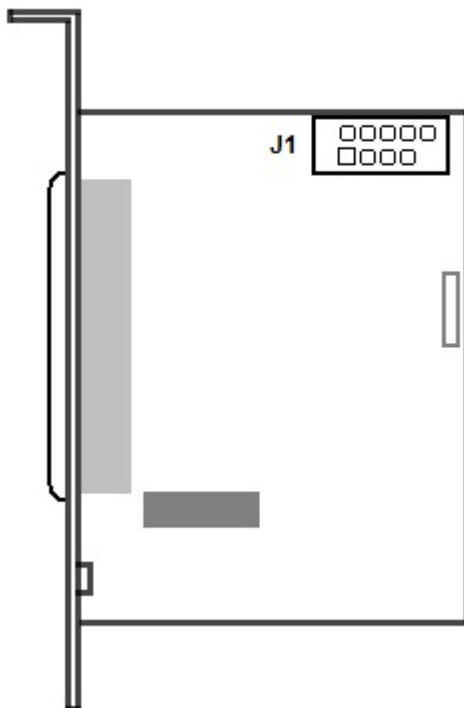

The device is controlled via the USB interface. Electrical and technical specifications of the card are given in the [Electrical and technical specifications of MO USBIO 4x4](#) section.

Connect the MO USBIO 4x4 card to the Server as follows:

1. Switch the computer power supply off. Remove the system cover.
2. Install the MO USBIO 4x4 card into a vacant motherboard slot and fix it in the casing.
3. Connect the loop (bundled with the distribution kit) to the **J1** connector and to a vacant USB connector on the motherboard of computer .

- To connect sensors and relays unsolder the connector bundled with the distribution kit. Unsoldering is made in accordance with the external connector pinout of the MO USBIO 4x4 card.

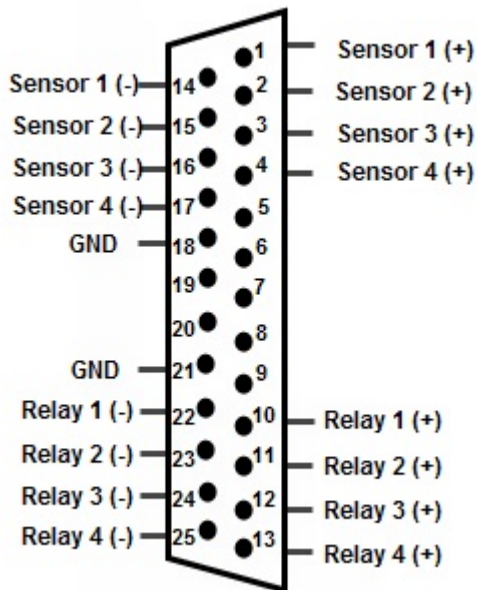

- Fix the unsoldered connector in the casing bundled with the distribution kit.
- Connect ready-for-use connector to external connector of the card in order to connect sensors and relays to the Server.

The MO USBIO 4x4 card is now connected.

2.3.5 Connecting AGRG-IO-16/8-WD-DS Sensor-Relay cards

The *AGRG-IO-16/8-WD-DS Sensor-Relay* card is an interface of external sensors and external executive devices (relays) as a part of video surveillance and fire and security alarm systems.

The figure shows the appearance of *AGRG-IO-16/8-WD-DS* card.



The layout of card connectors:

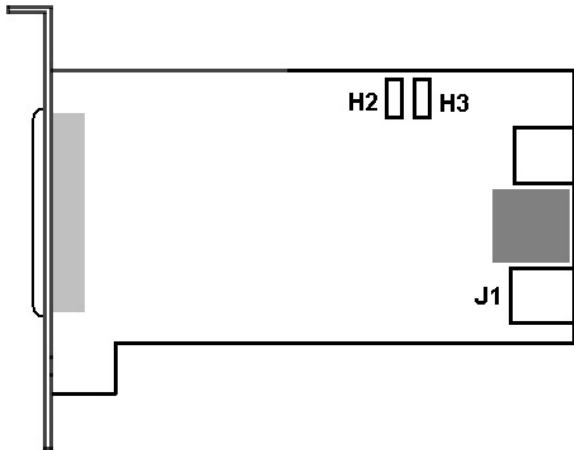

The device is controlled via the USB interface. Electrical and technical specifications of the card are given in the [Electrical and technical specifications of AGRG-IO-16/8-WD-DS devices](#) section.

Connect the *AGRG-IO-16/8-WD-DS* card to the Server as follows:

1. Switch the computer power supply off. Remove the system cover.
2. Install the *AGRG-IO-16/8-WD-DS* card into a vacant motherboard slot and fix it in the casing.
3. Connect the loop (bundled with the distribution kit) to the **J1** connector and to a vacant USB connector on the motherboard of the computer.
4. To activate the hardware control of the hang, connect the wires to the **H2 H3** connector (see Connecting the hardware control of the system to work).
5. To connect sensors and relays unsolder the connector bundled with the distribution kit.
 - a. The connecting wires from the executive devices are soldered to the contacts marked as "Relay" (see the table below).

Connector	Application	Connector	Application
1	Relay 1 (+)	26	Sensor 5
2	Relay 1	27	Sensor 5
3	Relay 2	28	Sensor 6
4	Relay 2	29	Sensor 6
5	Relay 3	30	Sensor 7
6	Relay 3	31	Sensor 7
7	Relay 4	32	Sensor 8
8	Relay 4	33	Sensor 8
9	Relay 5	34	Sensor 9
10	Relay 5	35	Sensor 9

Connector	Application	Connector	Application
11	Relay 6	36	Sensor 10
12	Relay 6	37	Sensor 10
13	Relay 7	38	Sensor 11
14	Relay 7	39	Sensor 11
15	Relay 8	40	Sensor 12
16	Relay 8	41	Sensor 12

- b. The connecting wires from the sensors are soldered to the contacts marked as "Sensor" (see the table below).

Connector	Application	Connector	Application
17	Sensor 1	42	Sensor 13
18	Sensor 1	43	Sensor 13
19	Sensor 2	44	Sensor 14
20	Sensor 2	45	Sensor 14
21	Sensor 3	46	Sensor 15
22	Sensor 3	47	Sensor 15
23	Sensor 4	48	Sensor 16
24	Sensor 4	49	Sensor 16
25	+ 12V (Output)	50	GND (Ground)

6. Fix the unsoldered connector in the casing bundled with the distribution kit.
7. Connect ready-for-use connector to external connector of the card in order to connect sensors and relays to the Server.

The *AGRG-IO-16/8-WD-DS* card is now connected.

2.4 Connecting MO USBIO 4x4 external module

The MO USBIO 4x4 module is an interface for external sensors (sensors) and external executive devices (relays) as a part of video surveillance and fire and security alarm systems.



External module is controlled via the USB interface. Electrical and technical specifications of the module are given in [Electrical and technical specifications of MO USBIO 4x4](#) section.

Configure the MO USBIO 4x4 external module as follows:

1. Connect the MO USBIO 4x4 module to the server via the USB cable included in the distribution kit.
2. To connect sensors and relays, unsolder the connector that is in the distribution kit. Unsoldering is made in accordance with the external connector pinout of the MO USBIO 4x4 module. Depending on the module modification one of the jack pinout shown in figure can be in use.

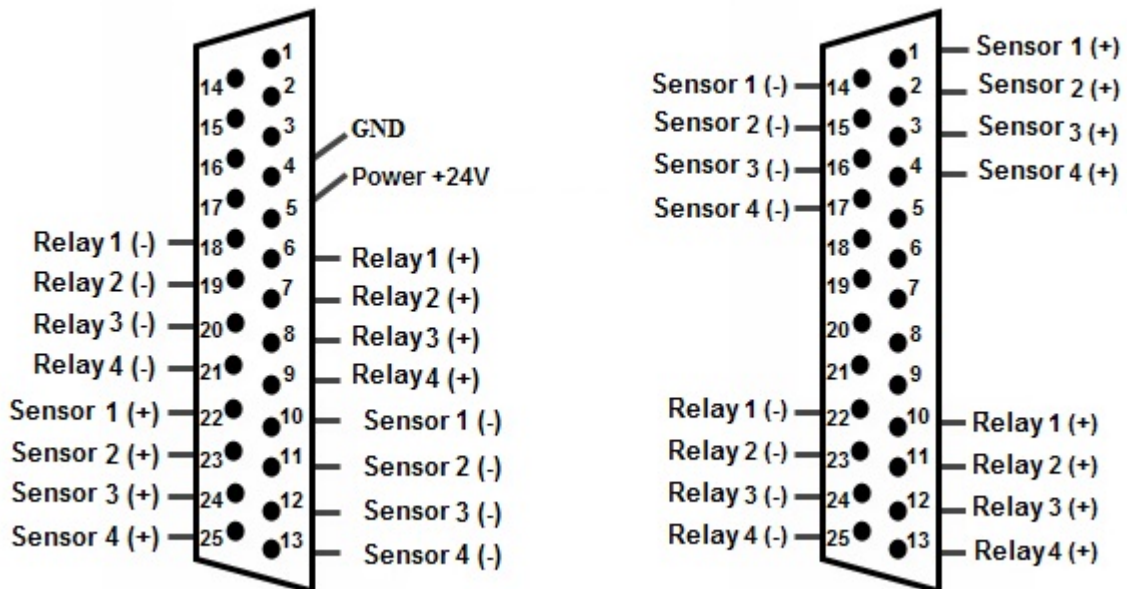

3. Fix the unsoldered connector in the casing in the distribution kit.
4. Connect ready-for-use connector to external connector of the card in order to connect sensors and relays to the Server.

The MO USBIO 4x4 external module configuration is completed.

2.5 Assembling and installing hardware components of audio subsystem

On the page:

- Supported audio cards and other audio input devices
- Options for increasing the number of audio input channels when standard audio cards are in use
- Installing audio input devices
- Installing microphones and loud speakers

Axxon PSIM™ software supports synchro video and audio recording and remote audio monitoring.

To enable operation of the audio subsystem, the Operator Workstation is to be equipped with optional equipment, such as audio cards, microphones, loud speakers and earphones.

2.5.1 Supported audio cards and other audio input devices

The following audio input devices can be used in the audio subsystem:

1. Standard audio cards installed in a computer or integrated into motherboards of computers.
2. Multi-channel audio cards such as Comart Hera, MidiMan Delta and Olkha 9P.
3. Ekholot USB-32, an external module for multi-channel audio signal input (32 channels).
4. Audio input channels of the network devices.
5. Audio input channels of FS/WS cards. As these cards do not have audio output channels for playing back the audio signal, an audio card is to be installed.

2.5.2 Options for increasing the number of audio input channels when standard audio cards are in use

Axxon PSIM™-based Server can process as many analog audio signals as specified in the license key.

As a rule a standard audio card has only one stereo audio input channel. To increase the number of audio input channels, the following options are offered:

1. Use a stereo audio input channel of a standard sound card as two independent mono-channels.
2. Use audio input channels of video capture cards.
3. Install several standard audio cards on the Server.

Note

Several audio cards of the same type installed within the system may cause conflicts in Windows OS.

4. Use multi-channel audio input cards (special audio cards support up to 16 independent audio input channels).
5. Use Ekholot USB-32, an external module for multi-channel audio signal input (32 channels).

2.5.3 Installing audio input devices

Information on how to install third-party audio cards and the drivers for them, as well as any other devices is given in the documentation bundled with specified equipment.

Sound channels of the network devices do not require any additional installation. The only requirement is that the device supports communication with the Server via the TCP/IP protocol.

2.5.4 Installing microphones and loud speakers

Microphones are to be installed in inaccessible places, ensuring unobstructed receipt of audio signals. Each microphone is connected to an audio card installed in a computer or to an audio connector on a video capture card.

Loud speakers or earphones designed for audio signal receipt are installed in the Operator Workstation. Loud speakers or earphones are connected to the audio output connector of the audio card.

The layouts of connectors for connecting microphones and earphones or loud speakers are given in the documentation bundled with audio cards.

Connectors bundled with a video capture card are used to connect microphones to these video capture cards.

2.6 Connecting PTZ devices and control panels

⚠ Attention!

Attention! Before one starts using a control panel or a PTZ device it is necessary to read the list of integrated devices and protocols at [AxxonSoft's official website](#). If the connected device is not in the list, then its operation is not guaranteed

PTZ device and control panel are connected to the Server via a vacant serial port (COM) (RS-232 interface).

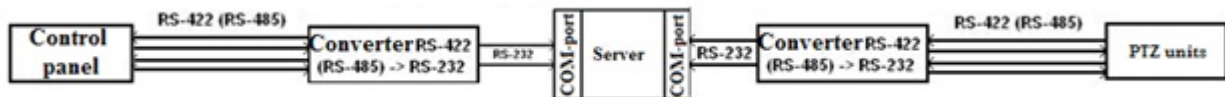

As a rule, PTZ devices use RS-422 or RS-485 interfaces. A PTZ device is connected to a COM port of the Server with RS-232 interface via RS-422 converter (RS-485) -> RS-232.

A PTZ device uses RS-422/RS-485 based on a 4-wires circuit (2 wires for receiving and 2 wires for transmission). To control PTZ devices in Axxon PSIM™, only 2 wires are used (transmitting data from the Server to the PTZ device). The **T+** and **T-** contacts of the converter are connected to the **R+** and **R-** contacts of the PTZ device.

The control panel is connected via converter RS-422 (RS-485) -> RS-232. Only two wires, connected to the Server, are used to control PTZ devices via control panel in Axxon PSIM™.

A PTZ device and control panel controlling this PTZ device are to be connected to one Server.

Detailed information on how to connect PTZ devices and control panels is given in the documentation accompanying the corresponding devices and converters. An example of controlling PTZ devices using the control panel is given in the [PTZ configuration](#) section.

2.7 Connecting and configuring network devices

Network devices allow remote video surveillance and audio monitoring using the TCP/IP telecommunication environment.

Network devices can be defined as a self-contained hardware and software modules integrated in the digital video surveillance system using the TCP/IP telecommunication environment. To use network devices, the system requires connection to the telecommunication network using the TCP/IP protocol to interact with other components of the digital video surveillance system.

Network devices for video surveillance and audio monitoring are:

1. network cameras (IP-cameras);
2. various types of network videosevers.

Network cameras are designed for video surveillance and transmission of the digital video signal to the users via the TCP/IP telecommunication environment.

Note

If a network camera is equipped with an analog camera instead of a digital one, then a video signal is at first digitized by an AD converter embedded in the camera and then transmitted to the users via the TCP/IP telecommunication environment.

Network videosevers are connected directly to the analog cameras; they digitize analog video signal and transmit it to users via the TCP/IP telecommunication environment. The users who use analog cameras connected to the network servers can use the same functionality range for the video stream playback and transmission, as the functionality of network cameras.

Network devices are connected to Server network card using the standard RJ-45 connector.

Detailed information on how to connect network devices to Server is given in the documentation for corresponding network devices.

2.8 Installing the expansion card for analog video out

There is a special option for viewing video sequences from surveillance cameras with the analog monitors – analog video out. To activate this option with FS-5, FS-6 and FS-16 video capture cards, the additional card is used – analog video out card.

The analog video out card is used for direct video signal output from one of the cameras connected to the Server to the analog monitor (with no digitization).

The analog video out card has three connectors compatible with FS-5, FS-6 and FS-16 video capture cards.

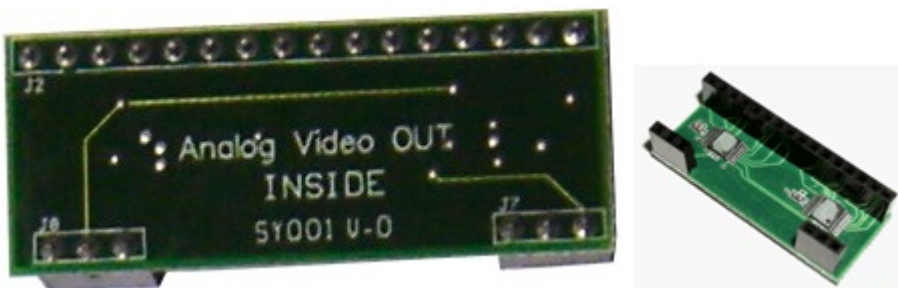

Install the analog video out card as follows:

1. Make sure that the video capture card power supply is off (either the computer with installed video capture card is off or the video capture card is not installed).
2. Install the analog video out card on the video capture card using special connectors on the video capture card.

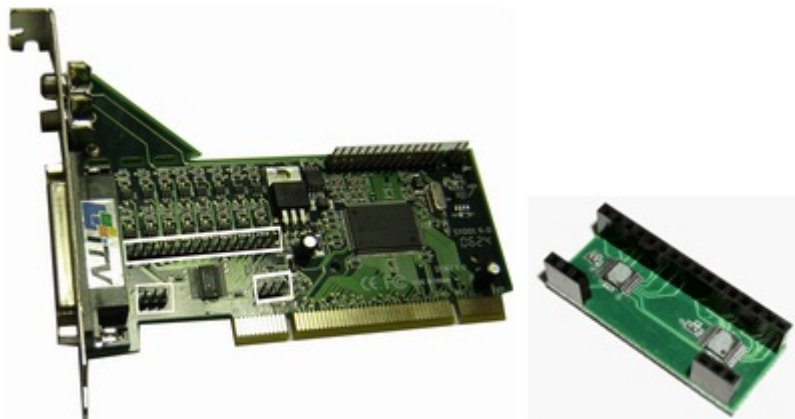

3. Connect the interface cable of the analog monitor to the red BNC connector of the video-in cable connected to the video capture card.

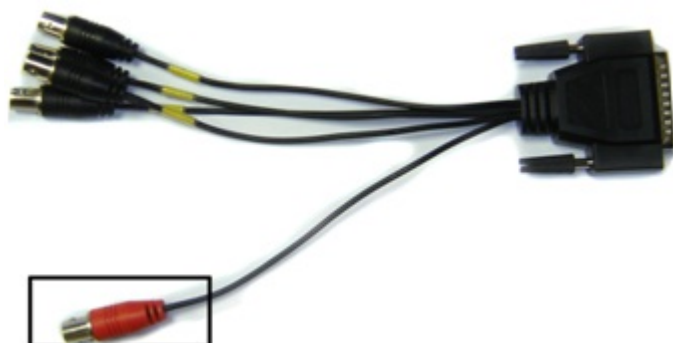

3 Configuring security system components in Axxon PSIM™ software

3.1 Configuring video capture cards in Axxon PSIM™ software

3.1.1 Video subsystem configuration

To configure a video subsystem in the *Axxon PSIM™* software create the **Video Capture Device** objects under which the **Camera** objects are created.

Creating and configuring the Video Capture Device object

Create the **Video Capture Device** object as follows:

1. Go to the **Hardware** tab in the **System settings** dialog box (1).
2. Select **Create object -> Video Capture Device** in the context menu of the **Computer** object (2).

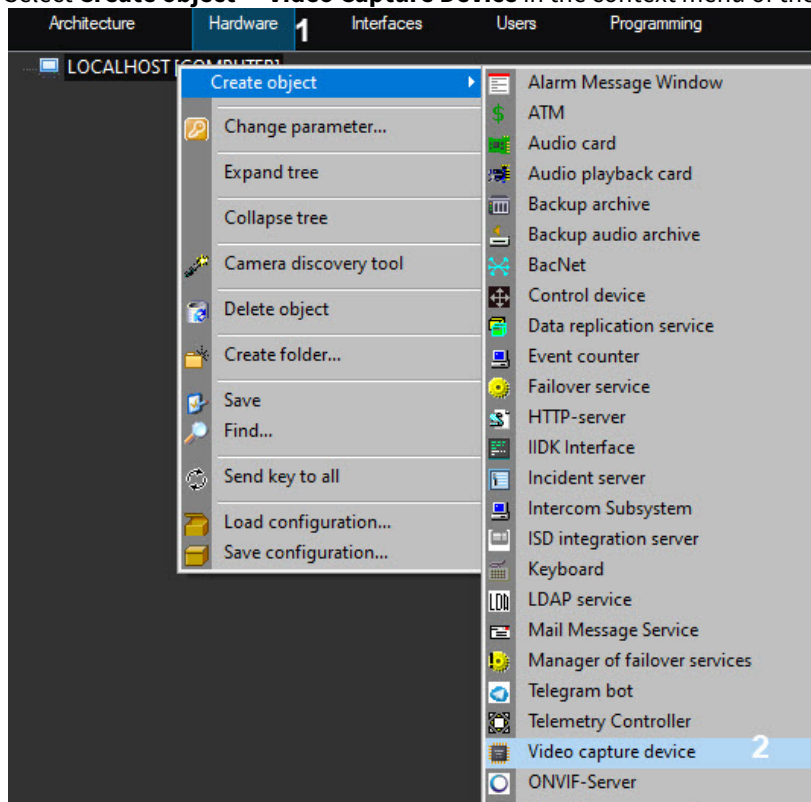

As a result, the basic settings toolbar is displayed.

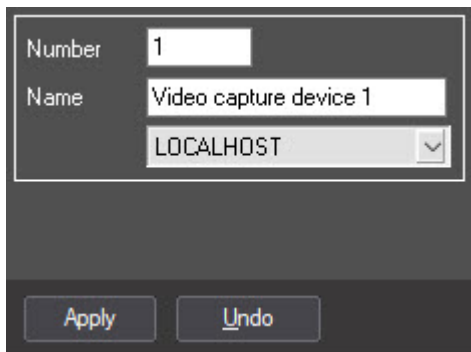

Note
Basic settings are set automatically. It is possible to change an ID, object name and parent object.

3. To create the object, click the **Apply** button.
4. Select the created object in the object tree (1).

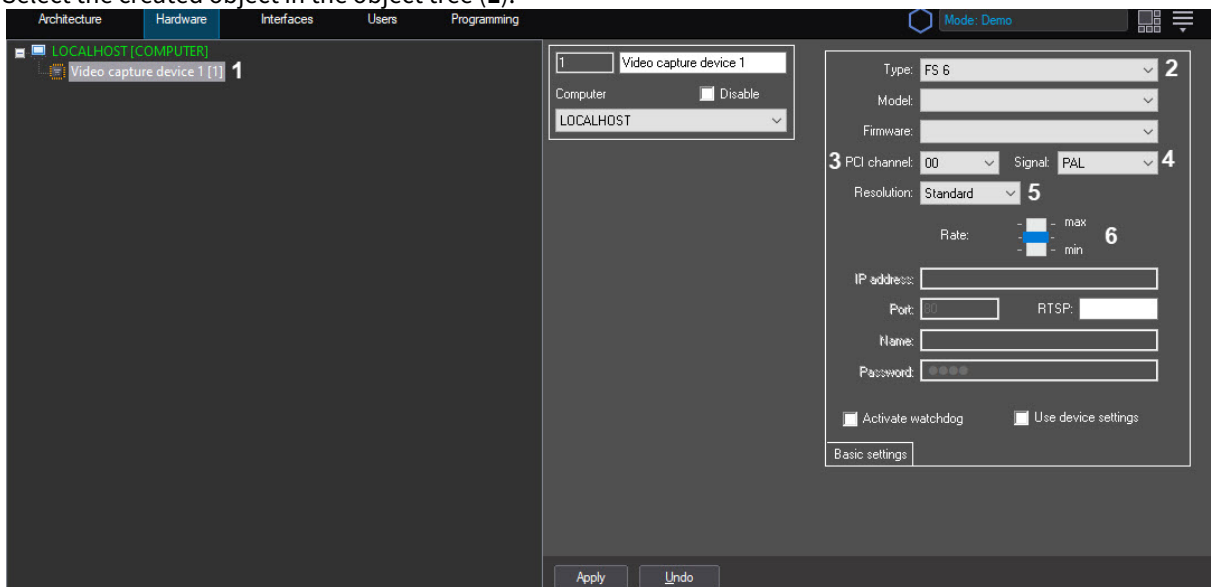

5. Configure the created object.
 - a. In the **Type** list, select the type of the video capture card installed on the Server (2).
 - b. Specify the PCI channel by selecting the value in the **PCI channel** list (3). For cards based on one chip model (ADC) and one driver (see [Drivers for video capture cards integrated into the Axxon PSIM™ software](#) section) there is end-to-end allocation of PCI channels that starts with '00'.

Note
While configuring SC300Q16 (FX4) or SC300D16 (FX8) or SC330Q16 (analogue of SC300Q16) or SC330D16 (analogue of SC300D16) video capture cards, take into account the correlation between the color of BNC video input interface cable and PCI channel specified by *Axxon PSIM™* software (see [Features of video subsystem configuration](#) section).

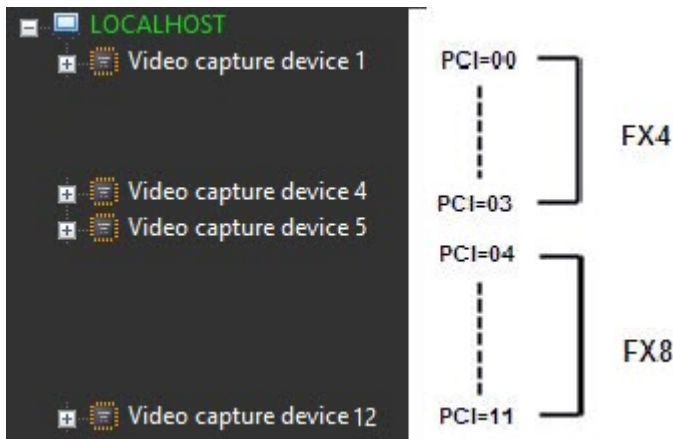

PCI channels allocation for cards based on one chip model (ADC)

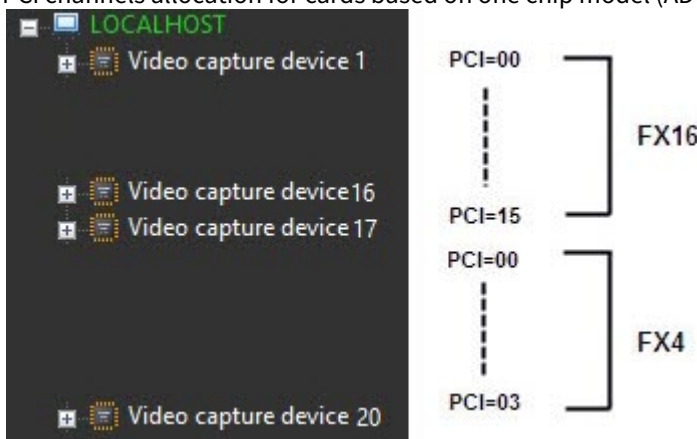

PCI channels allocation for cards based on different chip models (ADC)

- c. In the **Signal** list, select the type of video input (PAL or NTSC) (4).

Note
When Stretch VRC 6004, VRC 6008, VRC 6416 and VRC 7008L cards are used, the video input (PAL or NTSC) is selected automatically depending on the camera connected to the card. Change of this parameter does not affect the card operation.

Note
When SL16-200 (FX116)/FX416 cards are used, *Axxon PSIM™* software is to be restarted after changing the video input format. Otherwise, the previous settings are active.

- d. In the **Resolution** list (5) select the **Standard**, **High** or **Full** resolution with which the video signal is captured. This action is to be carried out when WaveHub, LinuxHub or LinuxServer are configured, otherwise this step can be skipped.
- e. Specify allowable frame rate for the card by setting the **Speed** slider into the corresponding position (6).

Value	Description
Max	Maximum allowable sum of video frame rate

Value	Description
Mean	Half of allowable sum of video frame rate
Min	One third of allowable sum of video frame rate

f. Click the **Apply** button to save the changes.

Setting the **Video Capture Device** object is completed.

⚠ Attention!

Configuration of one physical video capture card requires creation of several **Video Capture Device** objects (see [Features of video subsystem configuration](#) section).

Creating and configuring the Camera object

Create and configure the **Camera** object as follows:

1. Select **Create object** -> **Camera** in the context menu of the **Video Capture Device** object.

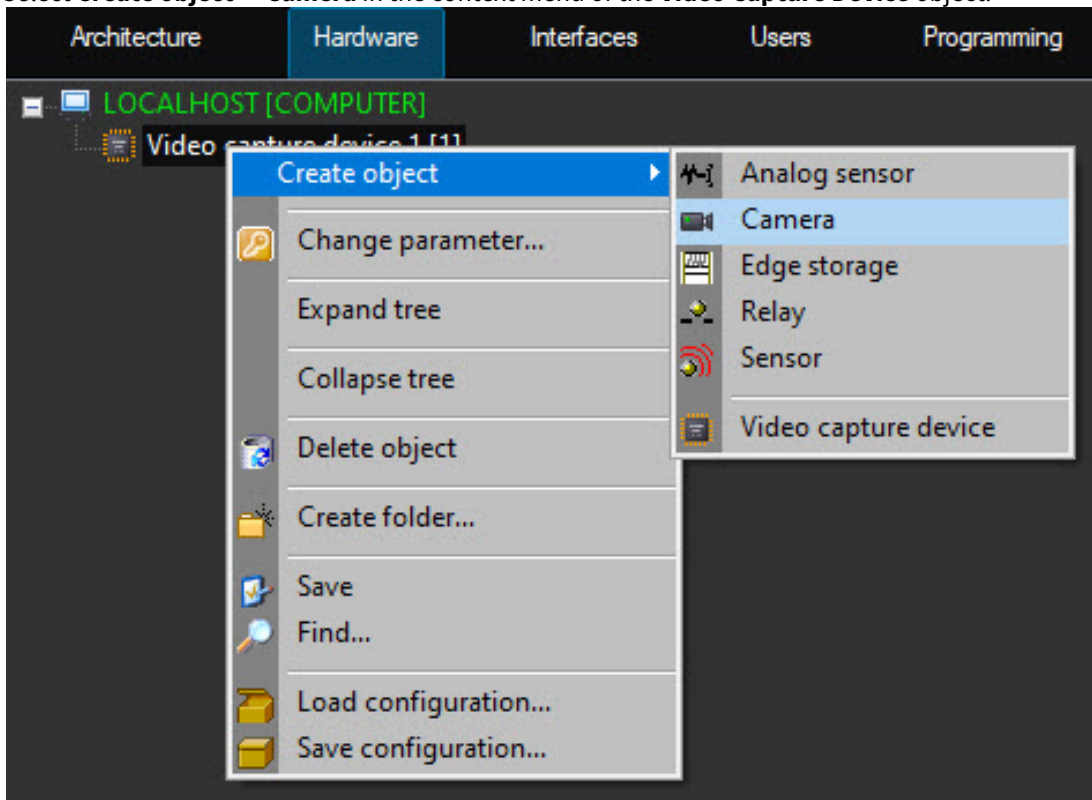

As a result, the basic settings toolbar is displayed.

i Note

Basic settings are specified automatically. It is possible to change an ID, object name and parent object.

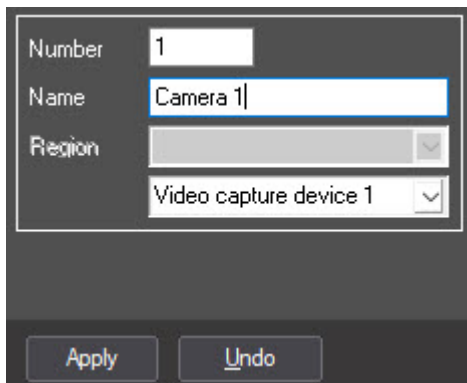

2. To create the object, click the **Apply** button.
3. Select the created **Camera** object in the object tree (1).

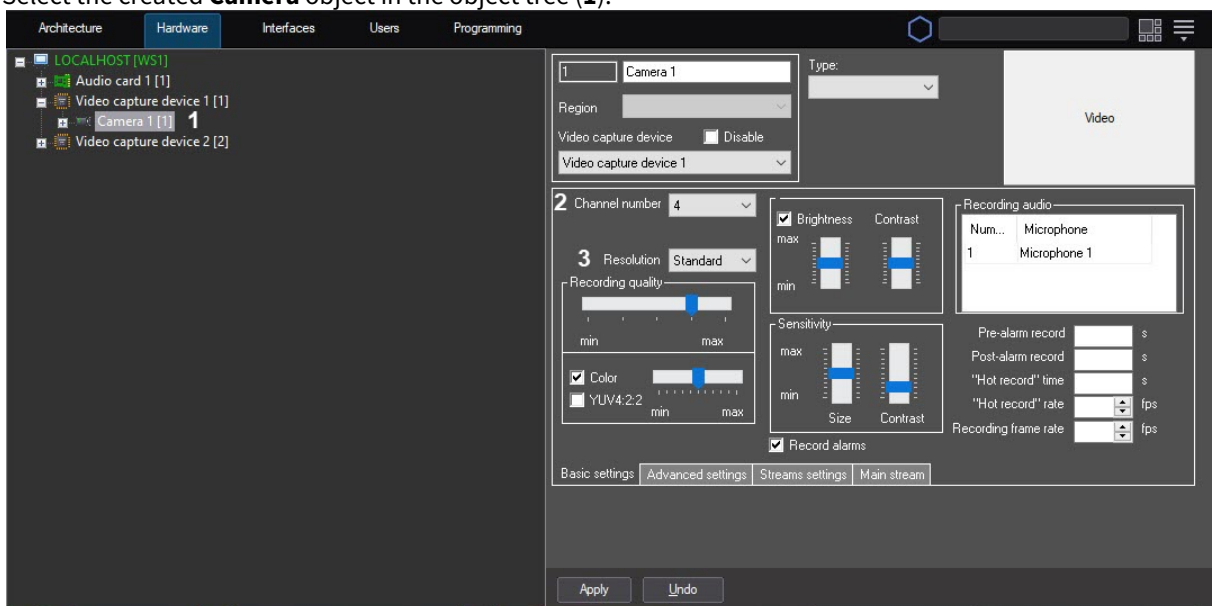

4. Configure the created object.
 - a. In the **Channel number** list (2) select a physical video output of the card to which the camera is connected (see [Features of video subsystem configuration](#) section).

Note

Channel numbers within one Video capture card must not be repeated.

- b. In the **Resolution** list (3) select the resolution: **Standard** – minimum accepted value for the card, **High** – mean value and **Full** – maximum accepted value with which a video signal is captured.

Note

Resolutions supported by video capture cards are given in [Appendix 4. Technical specifications of video capture cards](#).

Note.

While configuring the video camera which is connected through the SC590N4 video capture card, in the Axxon PSIM software the frame resolution is to be set as the resolution set on the video camera. Otherwise, artifacts can appear on the video image.

Note

If Stretch VRC-6404 HD video capture card is in use, then restart Axxon PSIM after changing resolution.

- c. Click the **Apply** button to save the changes

Configuring the **Camera** object is completed.

Repeat these actions for all cameras connected to the card.

Note

Number of the **Camera** objects that can be created under **Video capture card** object is specified in [Features of video subsystem configuration](#) section.

Note

Detailed description of all settings of the **Camera** object is given in [Administrator's Guide](#).

Configuring the analog video output

Expansion cards are used optionally and they bring out this functionality and installed directly on video capture cards. Axxon PSIM software brings out functionality of analog (decompressed and unprocessed) video output to external devices via corresponding BNC connector on video capture card (TV-out) (see [Installing the expansion card for analog video out](#) section).

Video outputting to analog monitor is made directly (without digitization) from one of the video cameras connected to Server.

Note

When configuring Axxon PSIM, take into account that outputting of analog video to analog monitor is possible from one camera only.

For video outputting to analog monitor a video capture card is to have an analog video output. An analog video output is integrated into FS-8 video capture cards. An extra analog video output card is to be installed for FS-5, FS-6 and FS-16 cards.

A video signal from any camera on the Server can be output to an analog monitor. By default, a video signal from the camera connected to the same video capture card as a monitor can be output to an analog monitor. To output video signals from any camera connected to any video capture card on the Server, solder analog outputs (interface cables) on all video capture cards on the Server.

Note

When an analog video out card is connected to a video capture card and analog monitor connector to the corresponding BNC-connector on the video capture card, analog video outputting to analog monitor is activated automatically.

Output the video from all cameras installed on the Server and connected to different video capture cards, to one analog monitor (perhaps when analog video outputs of cards installed on the Server are soldered) in tweaki.exe utility (Extended Axxon PSIM configuration) as follows:

1. Start **tweaki.exe** utility in the **Tools** folder of Axxon PSIM installation directory.
2. Select the **Video subsystem** section (1).

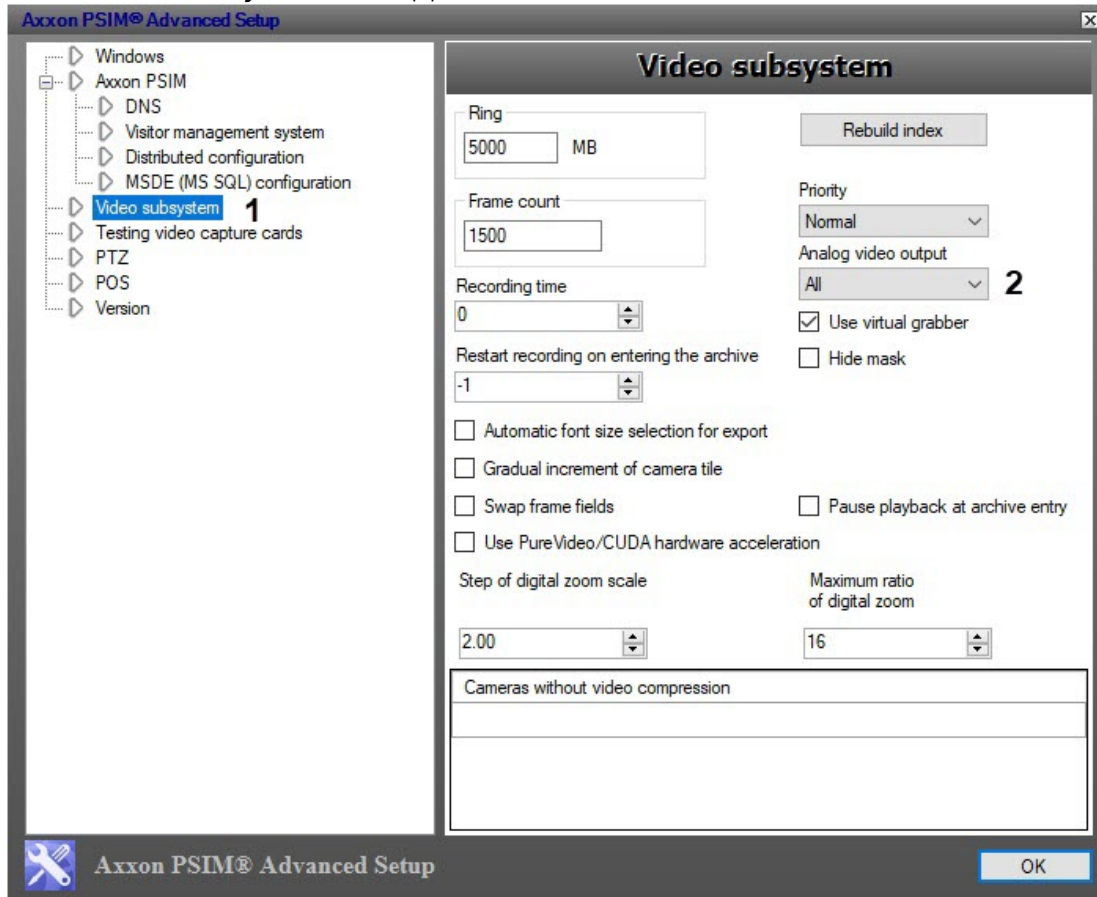

3. In the **Analog video output** list, select the **One** item to activate outputting video from cameras connected to different video capture cards to one analog monitor (2).
Video commutation (switching) while outputting them to analog monitor is performed only within cameras connected to one video capture. Changing the **Analog video output** parameter enables an extra program video commutator (switch) from all Server cameras connected to different video capture cards.
4. To save changes, click the **OK** button.

If several analog cards are used, then the switch between cameras video from which is output to one analog monitor is made via macros and scripts (programs). For example, for switching between two cameras, one can create macros given in the table.

Macro	Operations			
	Type	Number	Name	Operation
Macro 1	Video capture card			Switch analog video out off 1

Macro	Operations			
	Type	Number	Name	Operation
	Camera	1	Camera 1	Switch camera to output
Macro 2	Video capture card			Switch analog video out off 1
	Camera	2	Camera 2	Switch camera to output

Note

Details on how to make macros is given in [Administrator's Guide](#).

Configuring HikVision video capture card

Configure HikVision video capture card as follows:

1. Go to the **Hardware** tab in the **System settings** dialog box.
2. Create the **Video Capture Device** object under the **Computer** object.
3. Select **HikVision(<compressor>)** in the **Type** list on the settings panel of the object.

Note

Camera discovery tool can be used to configure HikVision video capture cards in *Axxon PSIM™* software (see [Camera discovery tool](#) section).

Configuring YUAN PD652 video capture card

Note.

The list of OS supported by YUAN PD652 video capture card can be found on the [official website](#).

Configure YUAN PD652 video capture card as follows:

1. Install the card [drivers](#), but first disable the check of drivers digital signature.
2. Remove *Axxon PSIM* and IP DriverPack.

Note.

Information on how to remove *Axxon PSIM* can be found in the [Removing Axxon PSIM™ software](#) section of [Administrator's Guide](#).
IP DriverPack is removed from the OS Windows control panel.

3. Install IP DriverPack. The installation file can be found in the `ipint.driverpack` folder of *Axxon PSIM* distributive.
4. Install *Axxon PSIM*.

Important!
First of all, install IP DriverPack and then install *Axxon PSIM*.

5. Connect cameras to YUAN PD652 and connect YUAN PD652 to the computer.
6. Start *Axxon PSIM*.
7. Start [Camera discovery tool](#).
8. Select **AxxonSoft** in the list of available devices.



Note.
The **capturedevice** item can be available in the list. It is to be disabled.

9. Click the **Apply** button.
10. Corresponding devices are added to the *Axxon PSIM* object tree.
11. Go to the settings panel of the created **Video Capture Device** object.

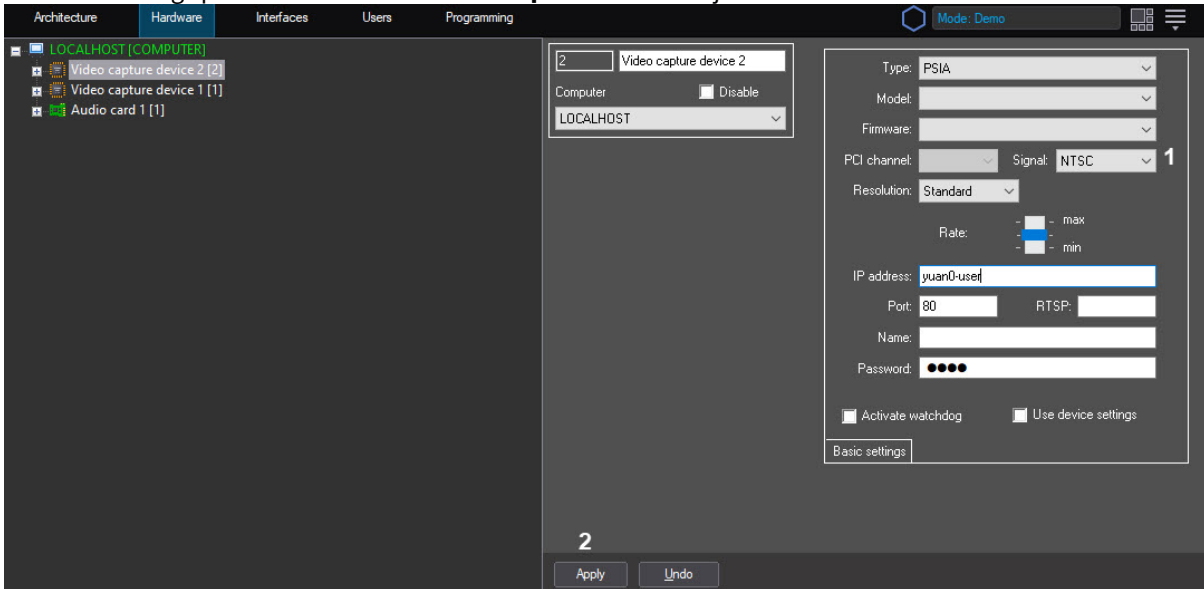

12. In the **Signal** dropdown list, select the type of signal supported by the device: **PAL** or **NTSC** (1).
13. Click the **Apply** button. (2)

YUAN PD652 video capture device is now configured.

3.1.2 Audio subsystem configuration

In *Axxon PSIM™* software the audio subsystem is configured with the help of the **Audio card** objects under which the **Microphone** objects (corresponding to connected audio devices) are created.

Creating and configuring the Audio card object

Create and configure the **Audio card** object as follows:

1. Go to the **Hardware** tab in the **System settings** dialog box (1).

2. Select **Create object** -> **Audio card** in the context menu of the **Computer** object (2).

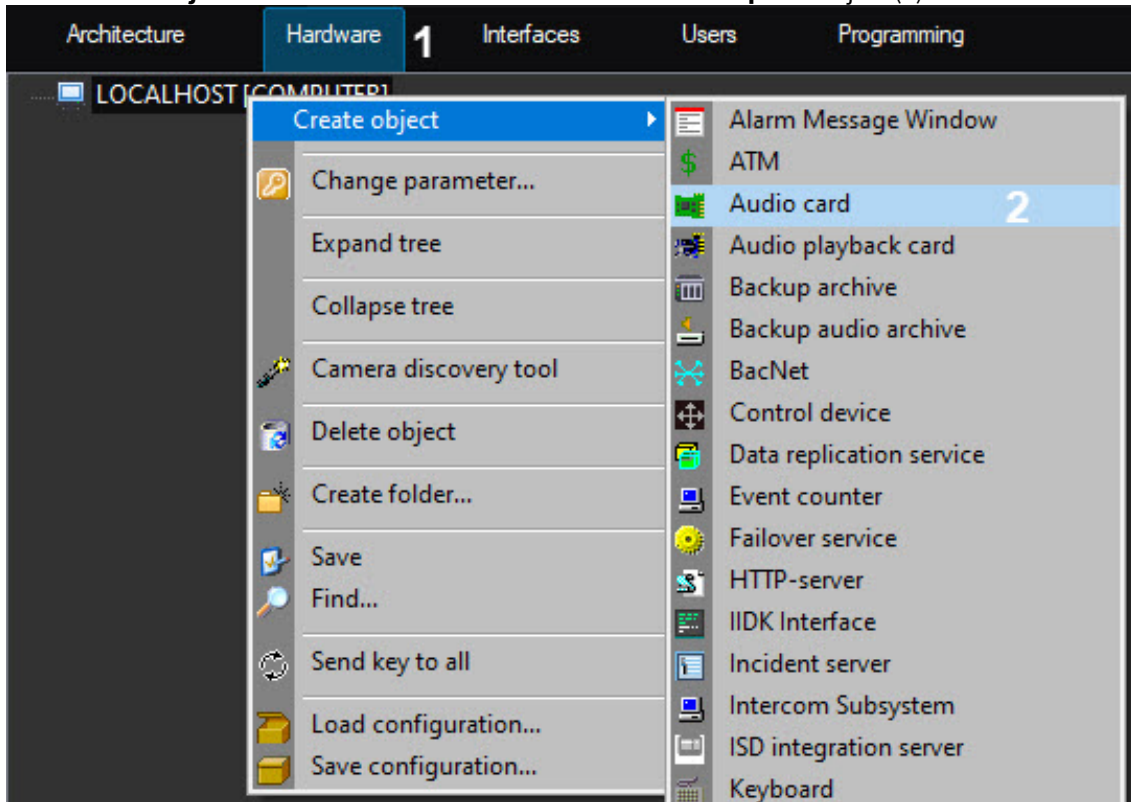

As a result, the basic settings toolbar is displayed.

Note

Basic settings are set automatically. It is possible to change an ID, object name and parent object.

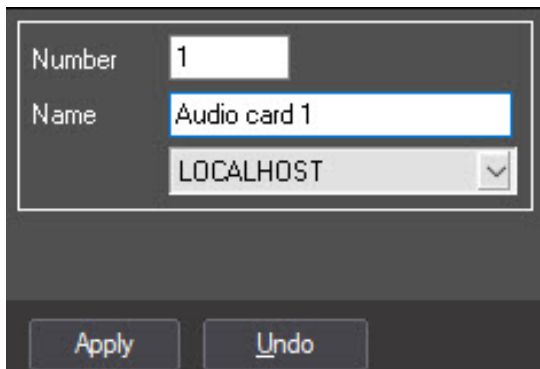

3. To create the object, click the **Apply** button.

4. Select the created **Audio card** object in the object tree (1).

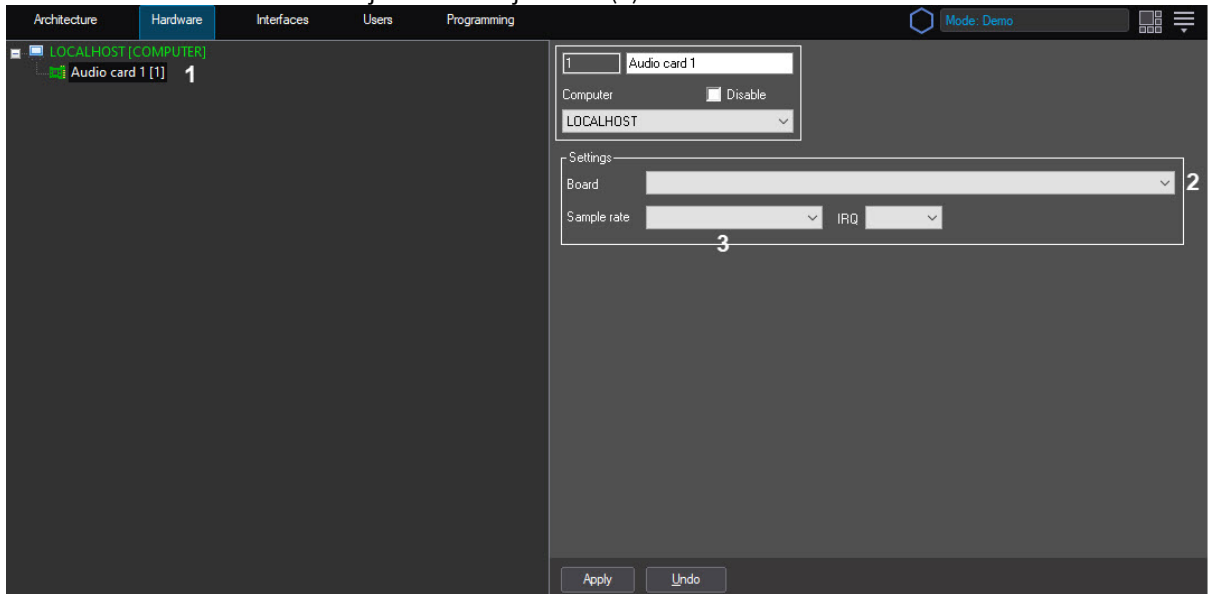

5. Configure the created object.
 - a. In the **Board** list (2) specify the type and PCI channel of the card. Between the **Audio cards** objects there is end-to-end allocation of PCI channels that starts with '0'.
 - b. In the **Sample rate** list, select the audio sample rate (3).

Important!

If audio is received from IP device, then the value selected in the **Digitization** dropdown list is ignored. In this case the digitization rate is set in the driver parameters on the **Microphone** settings panel (see [Configuring audio acquisition from IP devices](#)).

Note

Sample rate for SC510N4 (FX HD4, SA 7160PCI) card (specified in the **Sample rate** list) is to be the same as the sample rate on the video camera. If rate values are not the same then slow-/fast-motion is possible.

- c. Click the **Apply** button to save the changes.
6. Configuring the **Audio card** object is completed.

Attention!

To configure one physical video capture card the creation of several **Audio card** objects is required (see [Features of audio subsystem configuration](#) section).

Creating and configuring the Microphone object

Create and configure the **Microphone** object as follows:

1. Select **Create object** -> **Microphone** in the context menu of the **Audio card** object.

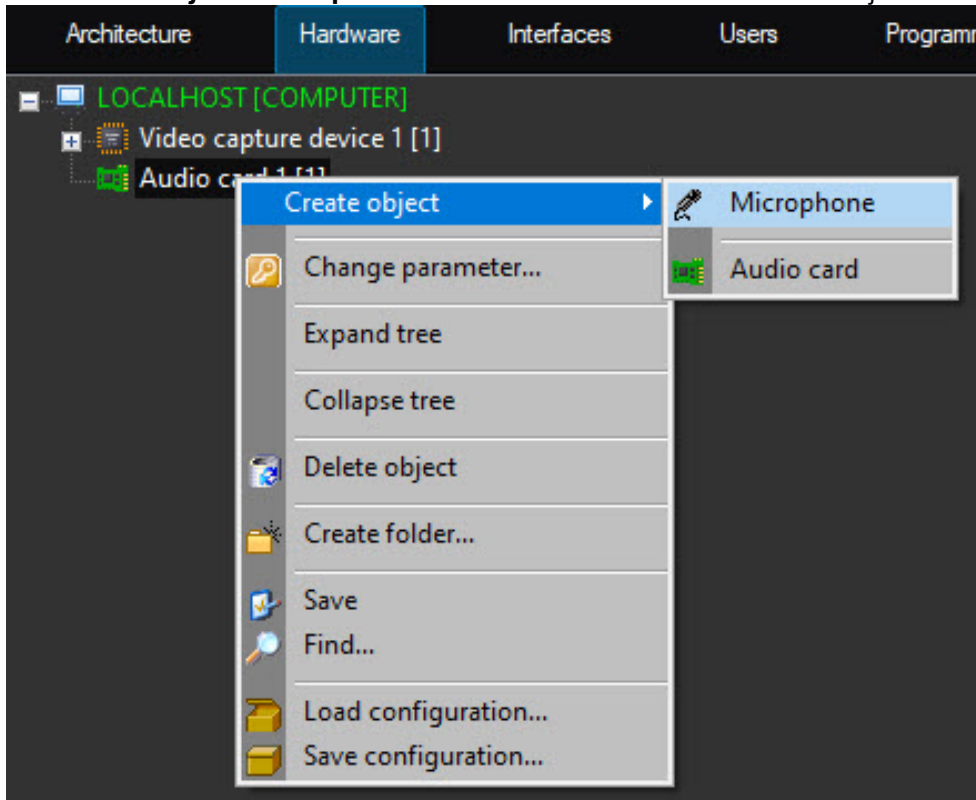

As a result, the basic settings toolbar is displayed.

Note

Basic settings are set automatically. It is possible to change an ID, object name and parent object.

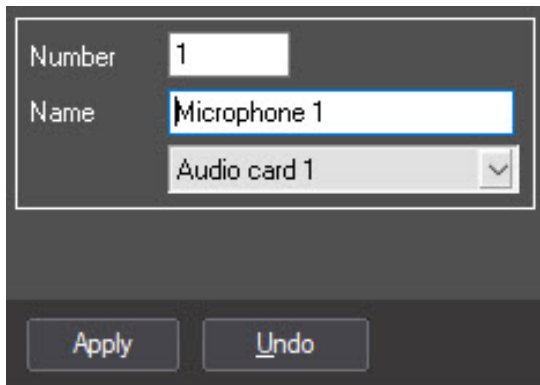

2. To create the object, click the **Apply** button.

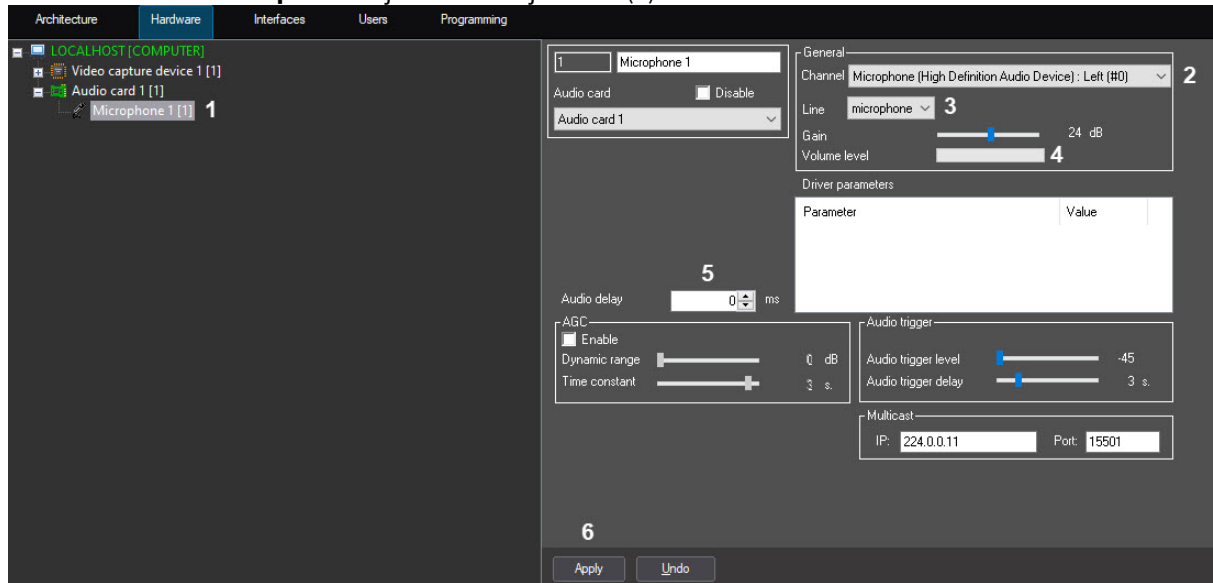
3. Select the created **Microphone** object in the object tree (1).

4. Configure the created object.

- In the **Channel** list (2) select the channel to which the audio device is connected (see [Features of audio subsystem configuration](#) section).
- In the **Line** list (3) select the device type (microphone, by default).
- Configure the level of sound volume using the **Increase** slider. Sound availability in the specific microphone and the increase value are in the **Volume level** graphic scale (4).
- In the **Audio delay** (5) field, sets the delay in milliseconds between the receiving of an audio signal from the audio input device and its output to the speaker / recording to the archive synchronously with the video signal. This parameter is used if the video image comes delayed or advanced, and the sound goes ahead or behind of it. The value range is -10000 to 10000.
- Click the **Apply** (6) button to save the changes.

Configuring the **Microphone** object is completed.

Note

Number of the **Microphone** objects that can be created under one **Audio card** object is specified in [Features of audio subsystem configuration](#) section.

Note

Detailed description of all settings of the **Microphone** object is given in [Administrator's Guide](#).

3.1.3 Initial configuration wizard

One can configure video subsystem automatically in *Axxon PSIM™* software using the initial configuration wizard.

Attention!

The initial configuration wizard is not available if at least one of the following conditions is met:

- Axxon PSIM™* software runs in *Axxon PSIM Demo* mode.
- Video capture card** or **Audio card** object(s) has already been created in *Axxon PSIM™* software.

3. *Axxon PSIM™* Server is configured from other Server in the distributed architecture.

Configure the video subsystem automatically as follows:

1. Go to the **Hardware** tab in the **System settings** dialog box (1).
2. Select the **Computer** object related to the required Server in the object tree in the **Hardware** tab (2).
3. Click the **Initial configuration wizard** button on the settings panel of the selected object (3).

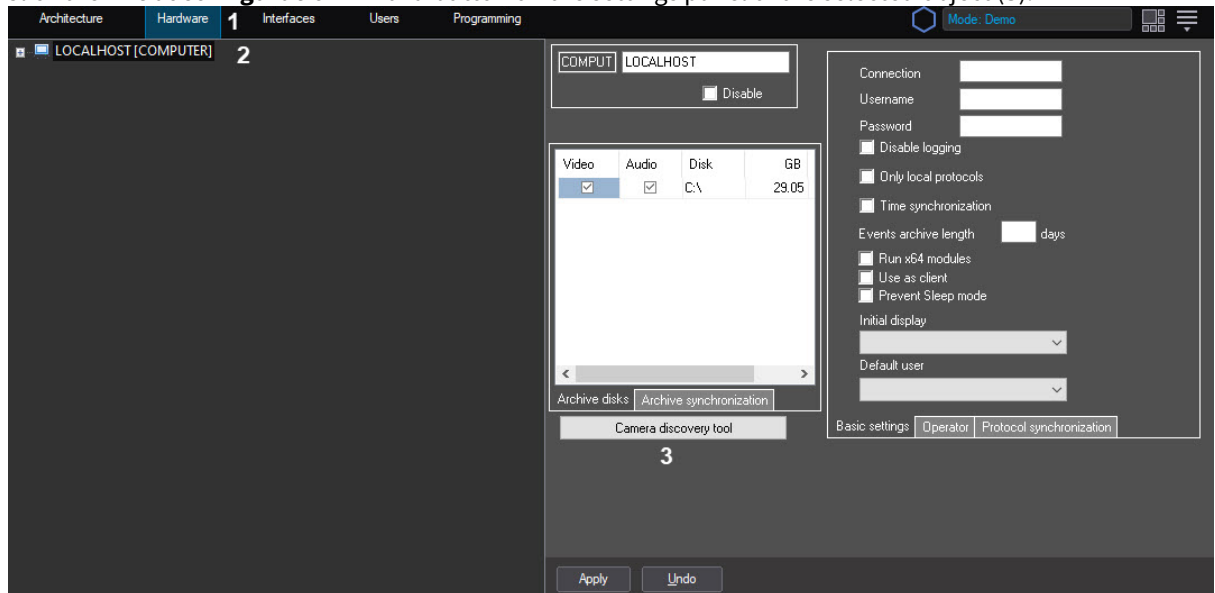

4. The **Creating initial configuration of the video subsystem** window is displayed.

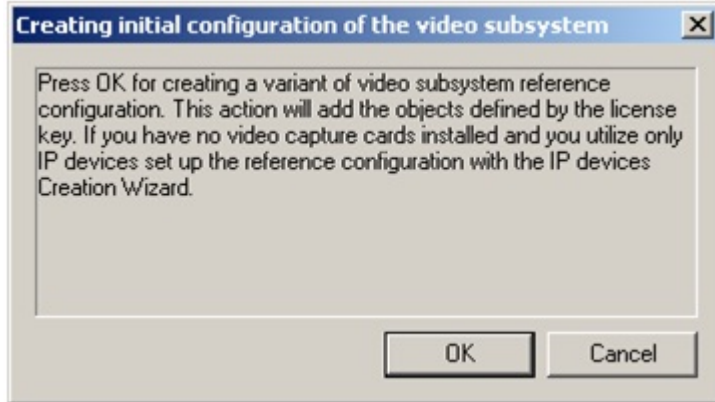

5. To create initial configuration of the video subsystem, click the **OK** button. This action will add objects based on Axxon PSIM software key.

6. As a result, the created objects are displayed in the object tree.

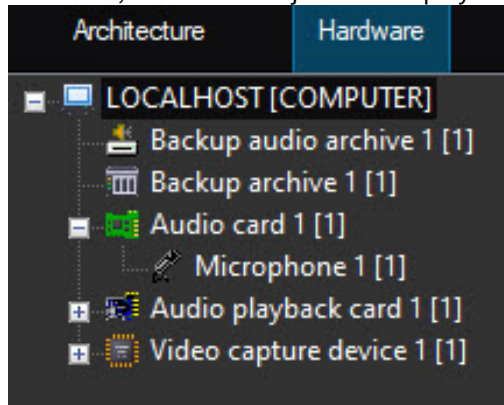

Note

The following objects are created as a result of initial configuration wizard working:

- a. The **Video Capture Device** objects (specified in the key) that correspond to the physical video capture cards (for example, 4 **Video Capture Device** objects are created for one FS6/16 video capture card);
- b. The **Camera** objects - one for each **Video Capture Device** object;
- c. The **Audio card** object configured to work with a local audio card;
- d. The **Microphone** objects under the **Audio card** object (the number of the **Microphone** objects is equal to the number of audio channels in the key).

Initial configuration wizard does not create other objects that are given in the key.

The automatic configuration of video subsystem is completed.

3.1.4 Configuring the Watchdog hardware performance tester

Hardware performance tester is used for computer autoreboot in case of the Windows OS or main *Axxon PSIM* software modules failure.

Axxon PSIM™ software allows configuring the Watchdog hardware performance tester when using video capture cards that support this functionality (see [Appendix 3. Technical specifications of video capture cards](#)).

The Watchdog hardware performance tester on the Server with installed video capture cards is configured in 3 stages:

1. Make sure that the Watchdog hardware performance tester is connected correctly (see [Connecting the Watchdog hardware performance tester](#) section).
2. Activate the function of the Watchdog hardware performance tester on the settings panel of the **Video Capture Device** object.
3. Verify the Watchdog hardware performance tester.

Activate and verify the Watchdog hardware performance tester as follows:

1. Go to the **Hardware** tab in the **System settings** dialog box.

- Set the **Activate watchdog** checkbox on the settings panel of the **Video Capture Device** object corresponding to one ADC on the card to which the Watchdog is connected (1).

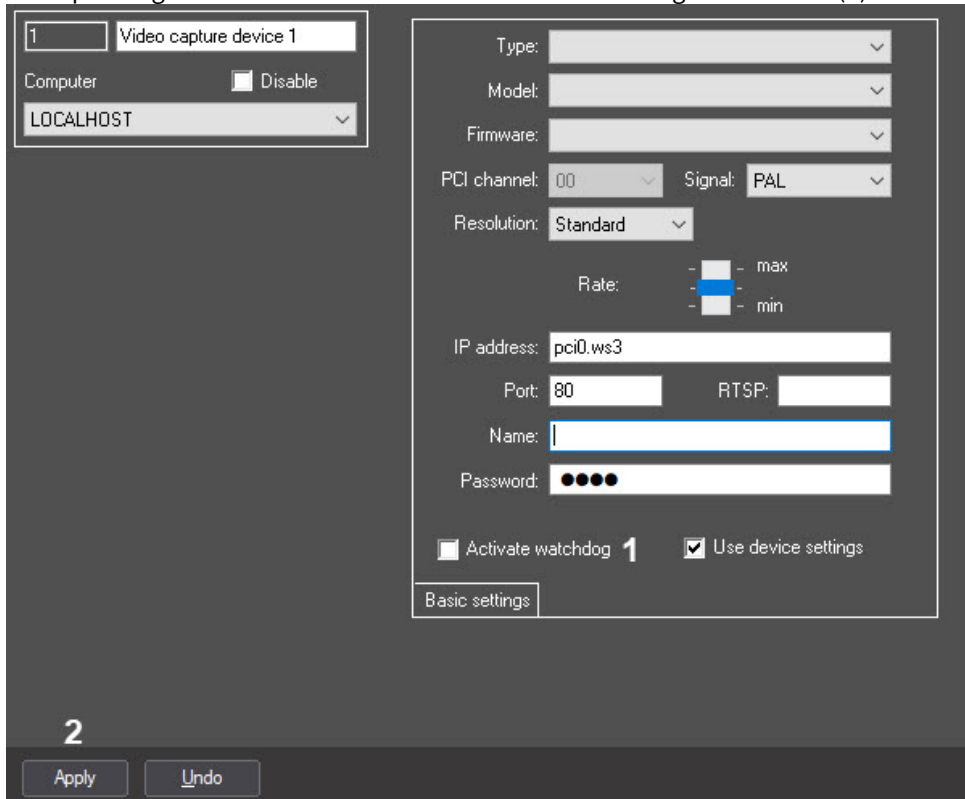

Note

When SC300Q16 (FX4), SC300D16 (FX8) or SC310N16 (FX16) as well as SC330Q16 (analogue of SC300Q16) or SC330D16 (analogue of SC300D16) video capture cards are in use, set the **Activate watchdog** checkbox checked in the settings of every **Video Capture Device** object created for the card to which the Watchdog is connected.

Note

The **07** PCI channel is to be selected for one of the **Video Capture Device** objects corresponding to the ADC of FS8 card for correct operation of the Watchdog hardware performance tester on FS8 video capture card. At the same time the Watchdog hardware performance tester can be activated on the settings panel of any **Video Capture Device** object of FS8 card.

- To save the changes, click the **Apply** button (2).

4. End the **video.run** process using the Windows task manager.

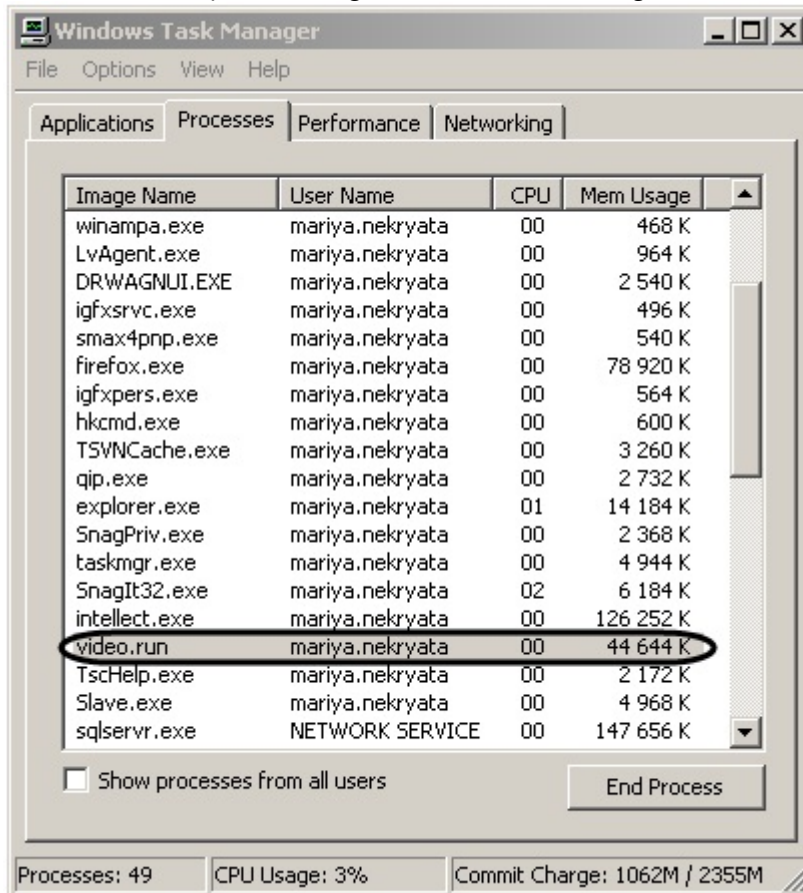

5. If the Watchdog hardware performance tester is connected and configured, then there is Windows reboot.

Note

On SC200Q4 (FS15) and FX video capture cards Windows reboots in several minutes after ending the **video.run** process.

Activation and verification of the Watchdog hardware performance tester is completed.

3.2 Configuring IP devices

3.2.1 General information on IP devices

Axxon PSIM™ software allows receiving, digitizing, processing and playing back the audio and video with the help of IP devices. IP cameras and IP servers can be used as IP devices for receiving, digitizing and processing the video.

IP device is configured with the help of Web server or another software bundled with this device and *Axxon PSIM* configuration.

Process parameters (size, frame rate, frame resolution, brightness, contrast, color saturation and color format) and parameters of video compression are set with the help of Web server or another software bundled with this device.

Axxon PSIM™ software receives and processes video with the help of detectors as well as records and transmits video from IP devices to remote workstations.

Axxon PSIM supports IP devices with dynamic IP address using DynDNS or other services. In these cases specify the address (hostname) given by DynDNS service instead of IP address when configuring IP devices.

Before using IP devices in Axxon PSIM™ make sure that process and digitization parameters (codecs) of IP devices installed with the help of Web server are supported by Axxon PSIM™. The list of IP devices compatible with Axxon PSIM™ and relevant information about the compatibility is shown on AxxonSoft's website in the 'Integration' section: http://www.axxonsoft.com/integrated_security_solutions/supported_ip.php.

3.2.2 Configuring video acquisition from IP devices

As a rule, IP devices allow processing one or more video signals depending on the type of device in use.

Note.

Axxon PSIM does not support IP devices over https protocol. To find details about transport protocols, see [Changing the transport protocol used by IP-device](#).

Every IP device used for video input is registered in Axxon PSIM™ software by creating and configuring the **Video Capture Device** object. The **Video Capture Device** objects are created in the **Hardware** tab under the **Computer** object.

The screenshot displays the configuration window for a video capture device. On the left, there is a sidebar with a tab labeled '1 Video capture device 1' and a 'Computer' dropdown menu set to 'LOCALHOST'. The main area is titled 'Basic settings' and contains the following fields:

- Type: Axis
- Model: Q1645
- Firmware: 9.80.1.1
- PCI channel: 00
- Signal: PAL
- Resolution: Standard
- Rate: A slider control with 'max' and 'min' labels.
- IP address: 172.19.2.16
- Port: 80
- RTSP: (empty field)
- Name: root
- Password: (masked with dots)
- Activate watchdog
- Use device settings

At the bottom of the window, there are 'Apply' and 'Undo' buttons.

When the **Video Capture Device** objects are created the following parameters are to be set for every IP device:

1. In the **Type** list, select IP device Vendor.
2. If the model and firmware is to be detected automatically, go to step 3. The **Model** and **Firmware** fields will be filled in automatically after the connection settings are applied.
 - a. In the **Model** list, select IP device model.

Note.

If the model is not in the list, it is not integrated. Consider [connecting IP device via one of the standard protocols](#).

- b. In the **Firmware** list, select the firmware on the device.
3. In the **IP address** field, specify the assigned network address of IP device. Information on how to assign IP addresses is given in [Assigning network addresses to IP devices](#) section.
4. In the **Port** field, specify the port number (TCP/IP) used for video transmission.

Note

In some cases you might also need to specify RTSP port – see [Features of configuring ONVIF or Hikvision IP devices behind NAT](#)

5. Specify the corresponding data in the **Name** and **Password** fields to log in Web server of IP device.
6. If the parameters set with the help of Web server or another software of IP device are to be used, then set the **Use device settings** checkbox.

Note

If video camera settings specified with the help of IP device software are not used in *Axxon PSIM™* software or used partially, then set the **Use device settings** checkbox unchecked and configure a video camera on the settings panel of the **Camera** object.

7. Click **Apply**.

After logging in *Axxon PSIM™* the values corresponding to numbers of connection channels of video cameras to IP device are to be given to the **Chanel number** parameters of the **Camera** object.

Note

Set the **1** value for the **Chanel number** parameter when IP camera is configured. Otherwise, IP camera is nonworking.

3.2.3 Configuring audio acquisition from IP devices

Every IP device used for audio input is registered in *Axxon PSIM™* by creating and configuring the **Audio card** object. The **Audio card** objects are created in the **Hardware** tab under the **Computer** object. When creating the **Audio card** objects in the **Board** drop-down list, select the value corresponding to the designation of IP audio device followed by its IP-address. This value is available in the drop-down list only if the **Video capture device** object corresponding to the IP-device is created and configured (see [Configuring video acquisition from IP devices](#) section). Also the **Audio card** and **Video Capture device** objects corresponding to the one IP-device should be created on the basis of the same **Computer** object.



When the **Audio card** is configured restart *Axxon PSIM™*. Otherwise, the audio subsystem (particularly, microphones) can not be configured.

Microphones embedded into or connected to IP devices are registered in *Axxon PSIM™* by creating the **Microphone** objects under the **Audio card** object. Under one **Audio card** object there are the **Microphone** objects in amount corresponding to the amount of audio input channels and restrictions applied by a license key. Corresponding segment of hardware branch when IP device and one microphone are registered is shown in the figure.



When the **Microphone** object is created, select the channel number of connecting the microphone to audio input device in the **Channel** dropdown list.

Moreover, driver parameters can be set in order to acquire audio from IP device. The list of available parameters depends on the device in use and it is shown in the **Driver parameters table on the settings panel of the Microphone object**.

Driver parameters	
Parameter	Value
Codec	G.711
Baud rate	64000
Encrypting	u-law
Gain	0

For instance, audio digitization rate (**Send rate**) can be set like this. The value of the **Digitization** parameter set on the settings panel of the parent **Audio card** object is ignored. Find details on how to select the codec and digitization rate in *Axxon PSIM* in [Configuring the digitization devices for audio signals](#) section in [Administrator's Guide](#).

If the video signal comes delayed or advanced, and the sound goes ahead or behind of it, i.e. the audio goes ahead or behind of the video, set the **Audio delay** parameter accordingly to eliminate the lag. The value range is -10000 to 10000.



3.2.4 Configuring the access to the archive in edge storage

General information on keeping video archive in edge storage

One can view video archive from embedded storage of IP devices (NVR video recorders) in *Axxon PSIM™* software package.

Access to video archive of edge storage is configured using the **Edge storage** object. Viewing video from external archive is carried out in the **Video surveillance** box. The details of its operation are given in [Operator's Guide](#) manual.

⚠ Important!

If *Axxon PSIM* is updated to 4.11.0 or later from older versions, re-configure the **Edge storage** objects.

Note.

Video is not recorded to edge storage via the **Edge storage** object in Axxon PSIM™ software package.

Note.

For the *Axxon PSIM* to work with embedded IP device storage, it is necessary to synchronize the time between the Server and the device in the web interface of the latter.

 **Edge storage playback**

Creating the Edge storage object

To create the **Edge storage** object, do the following:

1. Go to the **Hardware** tab in the **System settings** dialog box (1).

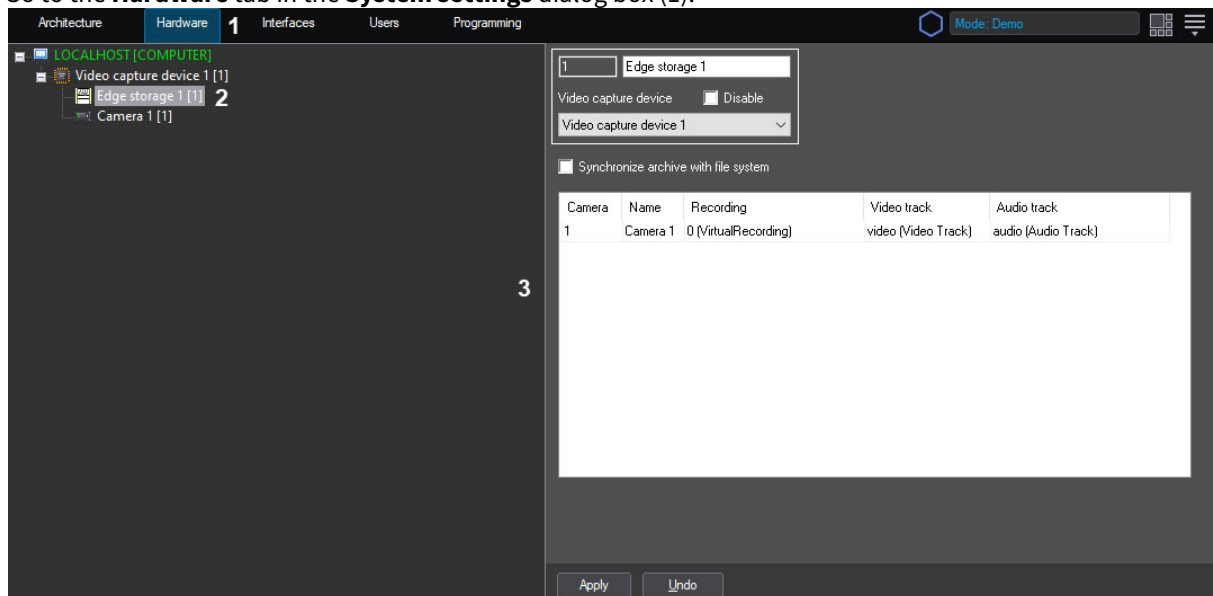

2. Create the **Edge storage** object in the objects tree of the **Hardware** tab (2). In the right part of the **Hardware** tab the setting panel of the selected object is displayed (3).

Connection parameters are configured on the **Video Capture Device** object settings panel – see [Configuring video acquisition from IP devices](#). If they are set correctly, after performing the steps above one can proceed to configure the list of cameras to access the edge storage (see [Setting the list of cameras to access the edge storage](#) section).

Important!

Only one child **Edge storage** object can be created under each **Video Capture Device** object.

Creation of the **Edge storage** object is completed.

Setting the list of cameras to access the edge storage

One can configure several cameras to view video from the edge storage. Each camera is configured for one channel of the device with edge storage.

If one camera is selected for viewing video from several edge storages, then the archive is viewed only from the archive that is matched with camera while the **Monitor** object is configured (see [Selecting and configuring video cameras](#) section).

To set the list of cameras to access the edge storage, do the following:

1. Go to the setting panel of the **Edge storage** object.

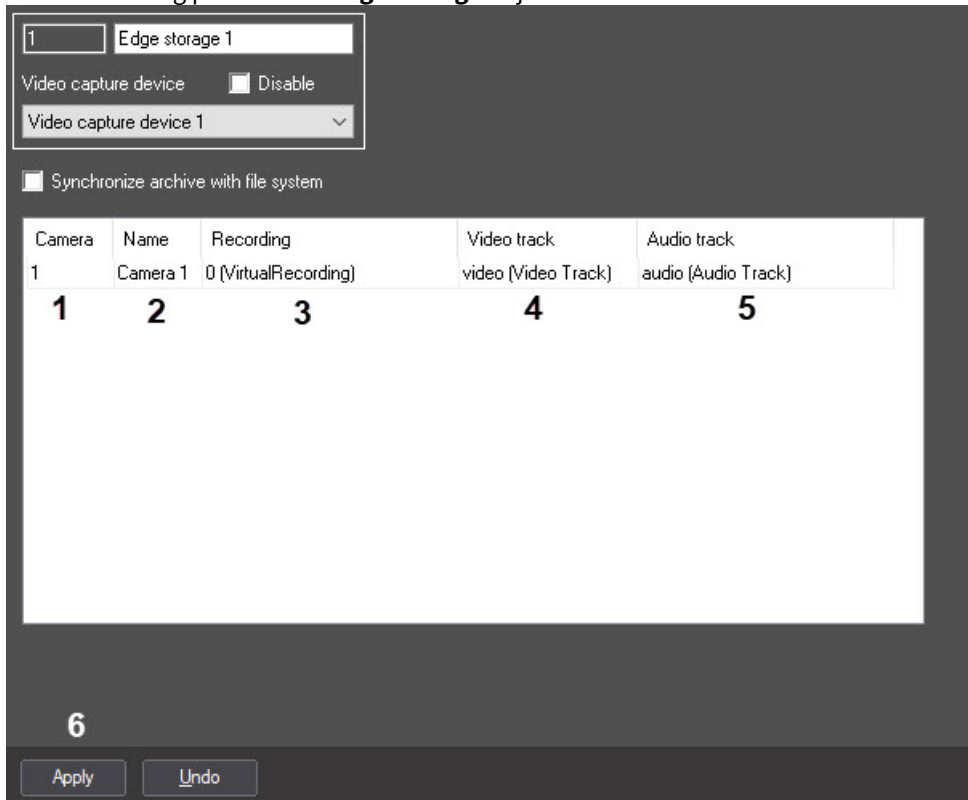

2. In the **Camera** column, specify the number of the camera used for video archive viewing (1).
3. Double left click in the **Name** field (2). This field is automatically filled with the name of selected camera.
4. In the **Recording** column, specify the channel of the device with edge storage that will be used by camera (3).

Note.
Recording names are received from the device with edge storage and are not changed in Axxon PSIM™.

5. After recording selection, video channel within selected recording is automatically selected in the **Video track** column (4). It can be re-selected if necessary.

Note.
Names of video tracks are received from the device with edge storage and are not changed in Axxon PSIM™.

6. In the **Audio track** column, specify the audio channel within selected recording (5).
7. Repeat steps 2-6 for all cameras that are to be used for viewing the archive from the edge storage.
8. To save all the changes, click **Apply** (6).

Setting the list of cameras to access the edge storage is completed.

Importing from edge storages

When *Axxon PSIM* is connected to the camera with edge storage, then video server performs recording the video archive from the camera. If the connection is lost, then recording is performed to the edge storage only. It is possible to import the video archive (for the time period when connection was lost) from edge storages to *Axxon PSIM* file system when the connection is restored. The archive is imported as follows:

1. Import to the Main video server archive. Video server always records the main archive. When connecting a camera the main video server archive requires the edge storage for the archive over the period when the camera was disconnected from the server.
2. Import to the Backup archive. The archive can be recorded onto several disks/partitions. When connecting a camera and activating the Backup archive, it requires the edge storage for the archive over the period when the camera was disconnected from the server.

To configure import to the Backup archive, select and configure cameras for copying to the Backup archive – see the [Selecting and configuring the cameras for the Backup archive](#) section, as well as set the schedule for archive copying when the connection is lost - see [Configuring the schedule of the video archive copying](#).

Important!

Create a specific **Backup archive** object to import from edge storage and backup copying of video server archive. Thus, the video archive is always divided into two parts: the archive over connection lost periods is in the specific Backup archive and the archive over periods when there is connection is in the Main and/or Backup archive of the video server.

Important!

In both cases, only videos recorded when the Server was disconnected are imported in order to avoid video duplication.

Use a script to force import if it was not performed automatically (see [IPSTORAGE](#)).

The time from which the synchronization should start is set by the SyncedTime parameter in the Settings.xml file – see [XML-file parameters reference guide](#). Also, the maximum possible synchronization period is set by the IpStorageSyncDepthHours key (see [Registry keys reference guide](#)). The time in the SyncedTime parameter can be changed when a new fragment appears in the archive provided that the synchronization is successful and forced by the UPDATE_TIME command (see [IPSTORAGE](#)).

Important!

It is not recommended to view the archive in the edge storage until the synchronization is completed in order to avoid video import.

Import from edge storages is enabled as follows:

1. Go to the settings panel of the **Edge storage** object.

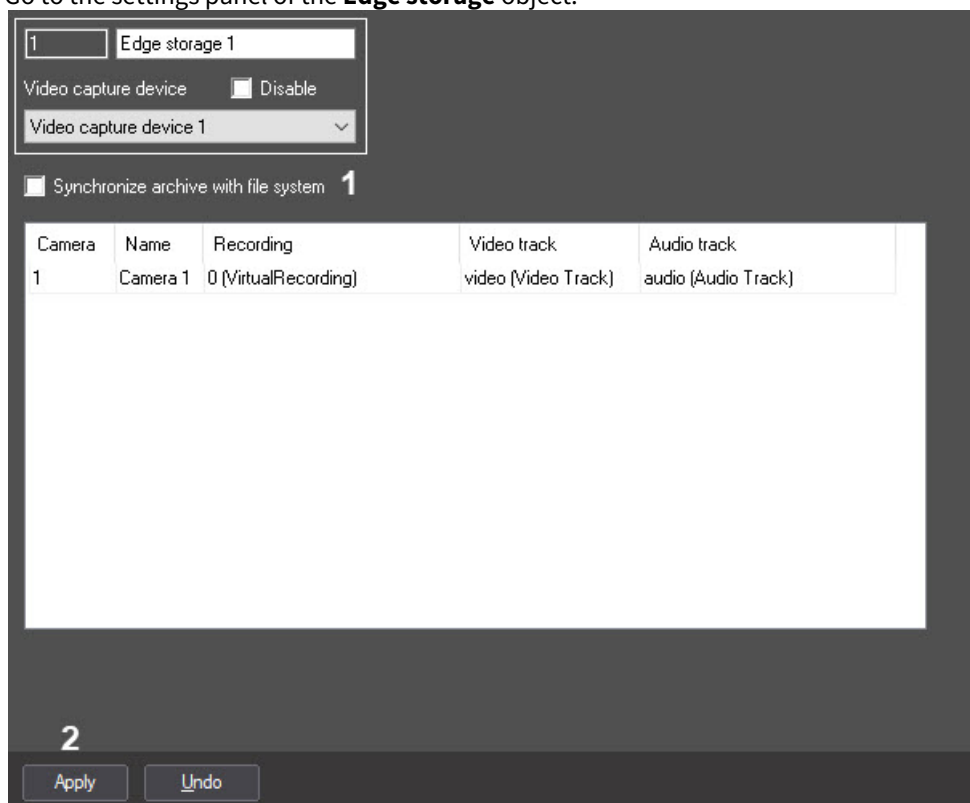

2. Set the **Synchronize archive with file system** checkbox checked (1).
3. Click the **Apply** button to save changes (2).

Import from edge storages is now enabled.

3.2.5 Camera discovery tool

Create IP devices in the *Axxon PSIM™* software as follows:

1. Go to the **Hardware** tab in the **System settings** dialog box (1).

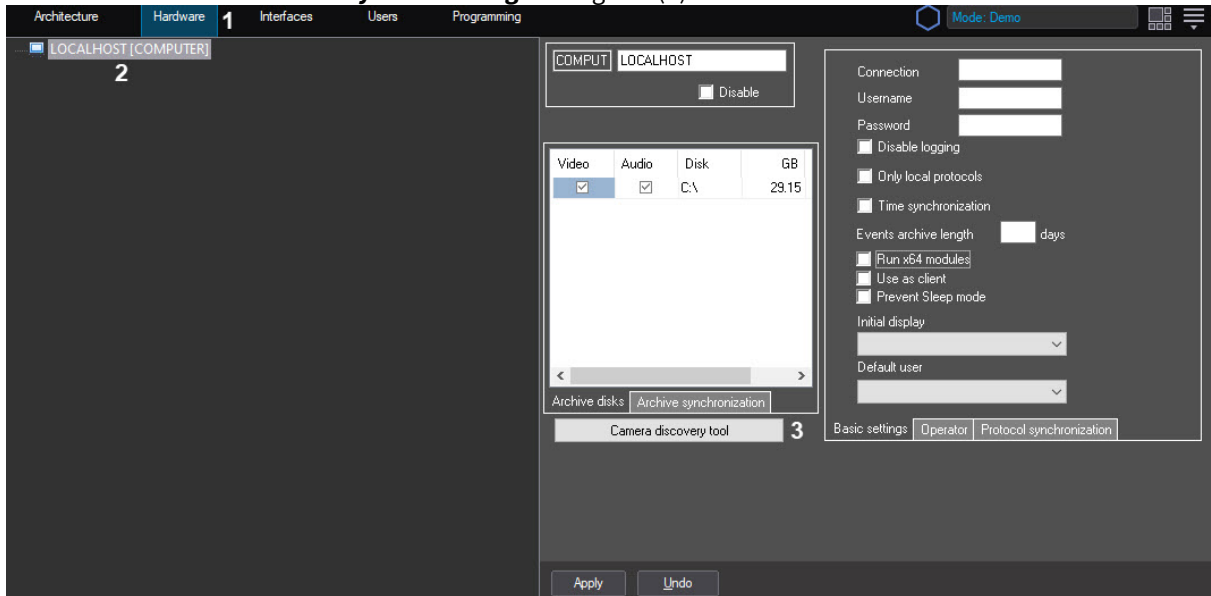

2. In the object tree, select the **Camera** object corresponding to the configured Server (2).
3. Click **Camera discovery tool** on the setting panel of the selected object (3).
As a result, the **IP Wizard** window is displayed. Found IP devices are displayed on the top of the window.

⚠ Important!

Video capture cards can also be displayed in the list. However, it is strongly NOT recommended to add them to configuration from the *IP Wizard* tool. Configure video capture cards manually as described in [Configuring video capture cards in Axxon PSIM™ software](#).

ℹ Note

The **IP Wizard** window can also be displayed by selecting the **Camera discovery tool** item in the context menu of the **Computer** object.

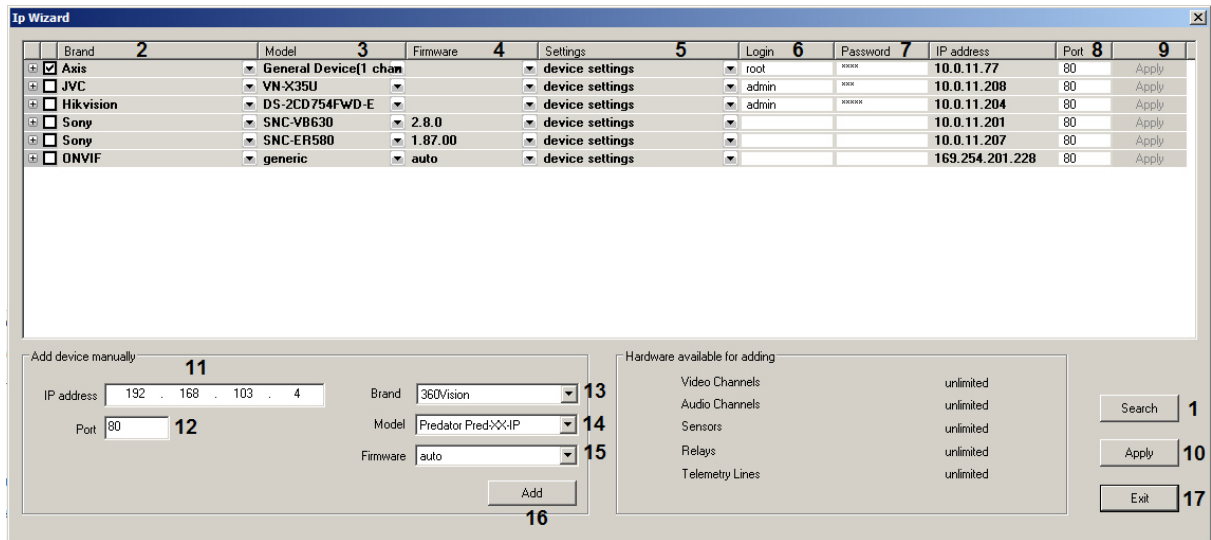
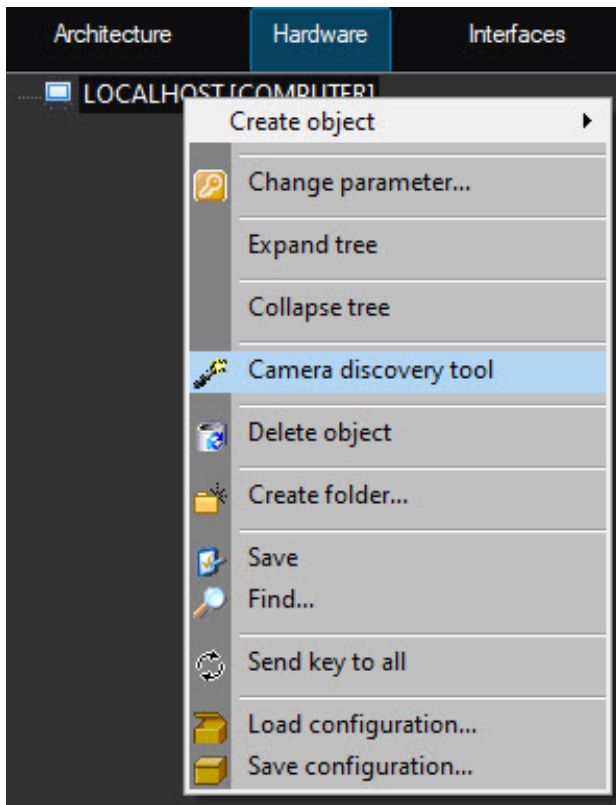

Click column name to sort devices by value in the column. Data are sorted alphabetically, including IP addresses. For example, when IP addresses are sorted in ascending order, 10.0.12.98 is lower than 10.0.12.252 in the list.

4. If the required device is not in the list, try clicking Search (1). Wait for the list is updated, as the search can take several seconds.
5. Check up the vendor (2), model (3) and firmware (4) for found IP device. Make changes if necessary by opening the corresponding dropdown list and selecting required value.
6. From the drop-down list (5) select settings which should be installed on the IP-device while its adding to the device tree: leave installed **device settings** or apply **video server settings**.
7. Check up the TCP/IP port (8). Specify the required value in the field.

8. Specify the login (6) and password (7) to connect IP device. Login and password are specified in the documentation for connected network device.
9. Select the objects that are to be created under IP device.

Note
The number of objects that can be created under IP device is displayed automatically in the **Hardware available for adding** table.

- a. Open the dropdown list of supported IP device by clicking the  button.



Correspondence of object names in IP Wizard to the branches of object tree is in table.

Name of object in IP Wizard	Branch of object tree in Axxon PSIM™
Video channel	The Video Capture Device object -> The Camera object
Audio input	The Audio card object -> The Microphone object
Contact	The Video Capture Device object -> The Sensor object
Executive device	The Video Capture Device object -> The Relay object
Telemetry line	The Telemetry controller object -> The PTZ device object
Audio output	The Playback card object -> The Loudspeaker object

- b. Set checkboxes for objects that are to be created.

Note
To create/delete all objects, set the checkbox checked/unchecked next to the vendor of IP device.

10. Click the **Apply** button (9) for one device or (10) if several devices are checked. The selected objects are created automatically in the **Hardware** object tree.
11. Repeat steps 4-8 for each IP device that is to be created in the system.

Note

To delete the IP-device from the **IP Wizard** window right – click the corresponding line in the table and select the **Delete camera <IP address> from the list** item. To delete the IP-device object or objects created under it from the hardware tree by means of the *IP Wizard*, set the checkboxes unchecked for corresponding objects and click the **Apply** button.

12. If the IP device has not been found, then add it manually.
 - a. Specify the IP address of device in the **IP address** field (11).
 - b. Specify the number of TCP/IP port in the **Port** field (12).
 - c. Select the vendor of IP device in the **Vendor** dropdown list (13).
 - d. Select the model of IP device in the **Model** dropdown list (14).
 - e. Click the **Add** button (15).
 - f. In the **Firmware** dropdown list, select the firmware installed on the IP device (16).
As a result, The IP device with specified parameters is displayed on the top of the window.
11. To complete the IP device creation, repeat steps 6-8.
12. Click the **Exit** button to close the IP Wizard window (17).

IP device creation is completed.

3.2.6 Connecting devices over standard protocols

Configuring multimedia receipt using RTSP protocol

To receive multimedia stream from a camera via RTSP protocol, the camera is to support this protocol. Information on RTSP support is in official reference documentation for the camera.

For proper operation of RTSP grabber functionality, make sure that no settings prevent data transmission via RTSP protocol.

Note.

To receive the RTSP stream it's required to set the multicast value to the rtsp parameter in the HKEY_LOCAL_MACHINE \SOFTWARE\AxxonSoft\Axxon PSIM\Video\TransportProtocols registry key for 32-bit system (HKEY_LOCAL_MACHINE \SOFTWARE\Wow6432Node\AxxonSoft\Axxon PSIM\Video\TransportProtocols for 64-bit) on computer where the **Camera** object is created if RTSP stream is received from the rtsp-server of the *Axxon PSIM* software (see [Configuring RTSP Server module](#)). More information about this parameter see in [Changing the transport protocol used by IP-device](#) section.

To receive video via RTSP protocol, do the following:

1. Create the **Video Capture Device** object under the **Computer** object in the **Hardware** tab of the **System settings** dialog box (1).

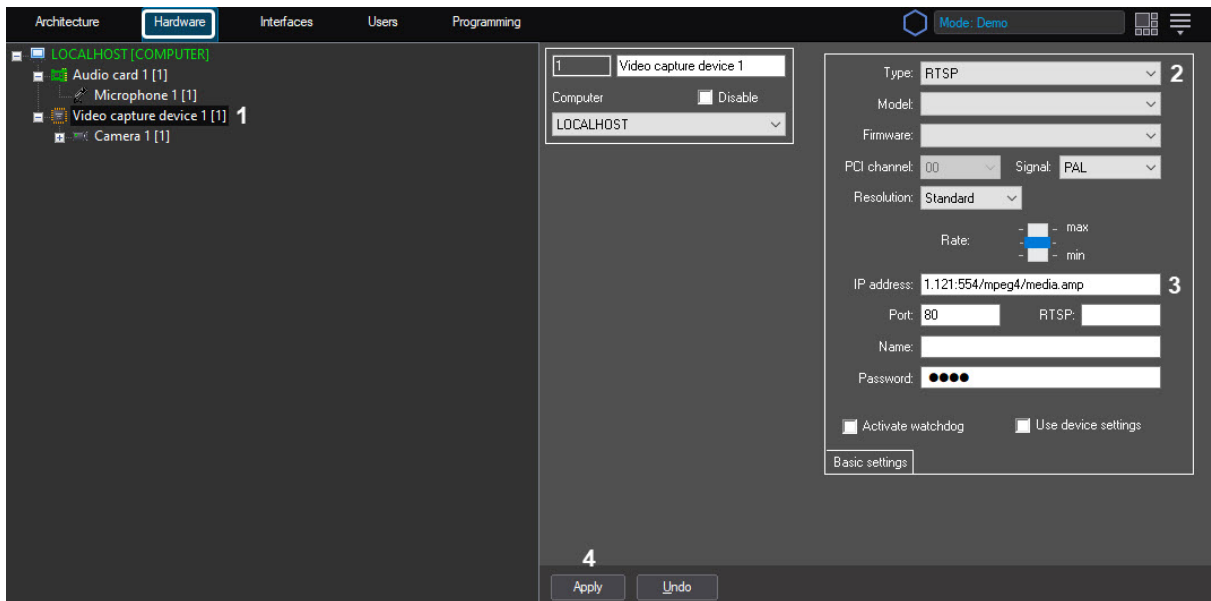

2. Go to the settings panel for the created object.
3. Select the **RTSP** value in the **Type** dropdown list (2).
4. Type-in the address of rtsp-stream in the IP field (3). The length of address is not to be longer than 100 characters.

The format of address depends on camera model and its firmware. It is specified in the technical documentation of the vendor. Generally it looks like this:

rtsp://[<username>:<password>@]<IP address of video source >:<port>/<path_to_stream>

Example

For Axis 210A camera the address of rtsp-stream looks like this: <rtsp://root:password@10.0.11.121:554/mpeg4/media.amp>

Example

The address to access rtsp-stream delivered by rtsp Server of Axxon PSIM, looks like <rtsp://192.168.0.3:554/1>. When rtsp Server operates in the **Multicast** mode, it cannot be accessed via RTSP grabber.

Receiving multiple streams via the RTSP driver has been implemented in Drivers Pack v. 3.2.28.1518 and over. Maximum 3 streams are supported. RTSP addresses are semi-colon separated in the IP field.

Example

To get video from two streams, specify <rtsp://admin:admin@10.0.26.16/live/h264;rtsp://admin:admin@10.0.26.16/live/mjpeg> in the IP field.

To get video from three streams:

<rtsp://admin:admin@10.0.26.16/live/h264;rtsp://admin:admin@10.0.26.16/live/mjpeg;rtsp://admin:admin@10.0.26.16/live/mpeg4>

Starting with Drivers Pack 3.62.2953, the receipt of an RTSP over HTTPS stream is supported. Before using this feature, first set the https transport protocol in the rtsp registry key (see [Changing the transport protocol used by IP-device](#) for details on this parameter). Example link for receiving an RTSP over HTTPS stream:

Example.
`https://192.168.0.3:443/profile1/media.smp; https://admin:admin@192.168.0.3:443/profile2/media.smp`

Important!
 If there are invalid characters in the username or password (for instance, "@"), they are to be screened using ASCII codes (hexadecimal format). The "@" character will be screened as %40. For instance, when connecting the device over RTSP the link can look like "[rtsp://admin:New%40edge@192.168.0.75:554/RVi/1/1](https://admin:New%40edge@192.168.0.75:554/RVi/1/1)". But if this data is in login and password fields of the **Video capture device** in *Axxon PSIM*, then they stay the same - "admin" and "New@edge" correspondingly.

- Click the **Apply** button to save the settings of the **Video Capture Device** object (4).
- Create the **Camera** object under the **Video Capture Device** object.

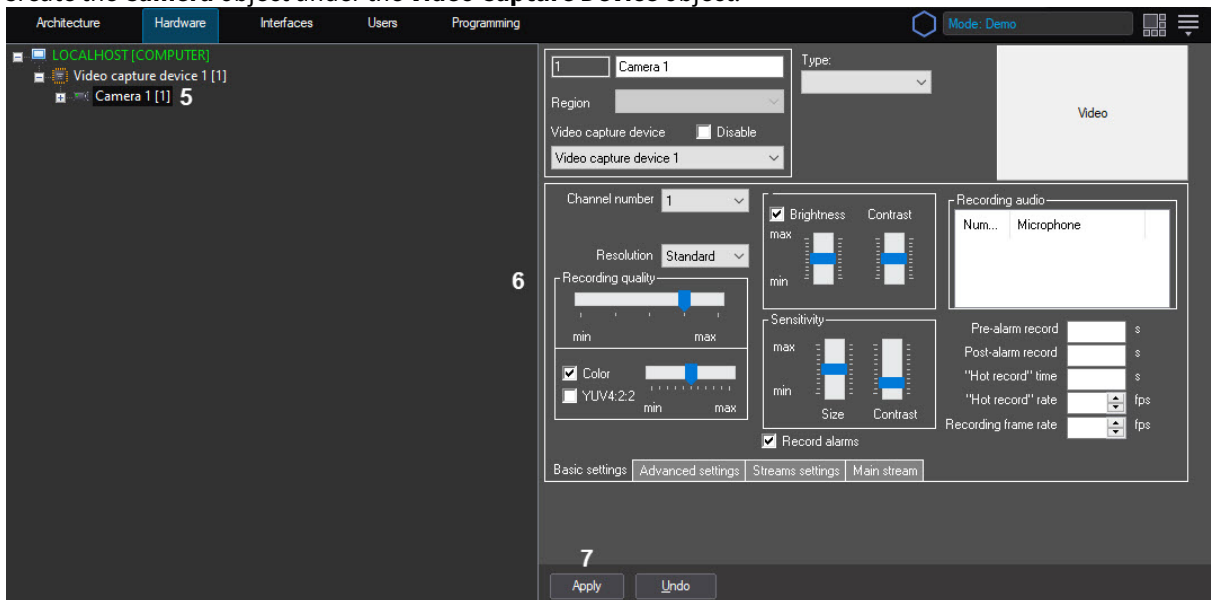

- Configure the created **Camera** object (5).
- Click the **Apply** button (6).
- Click the **Video** button to check if the video is available (7).

If the configuration is correct, video received via RTSP protocol is displayed in the viewing area. Further actions with received video stream are performed using the created **Camera** object.

Video-streaming via RTSP protocol is now configured.

To receive audio stream from a camera, create and configure the **Audio card** and **Microphone** objects for audio received via RTSP protocol. For this select the **RTSP** type of the **Audio card** (see [Registration of audio cards and microphones in Axxon PSIM™ software](#)).

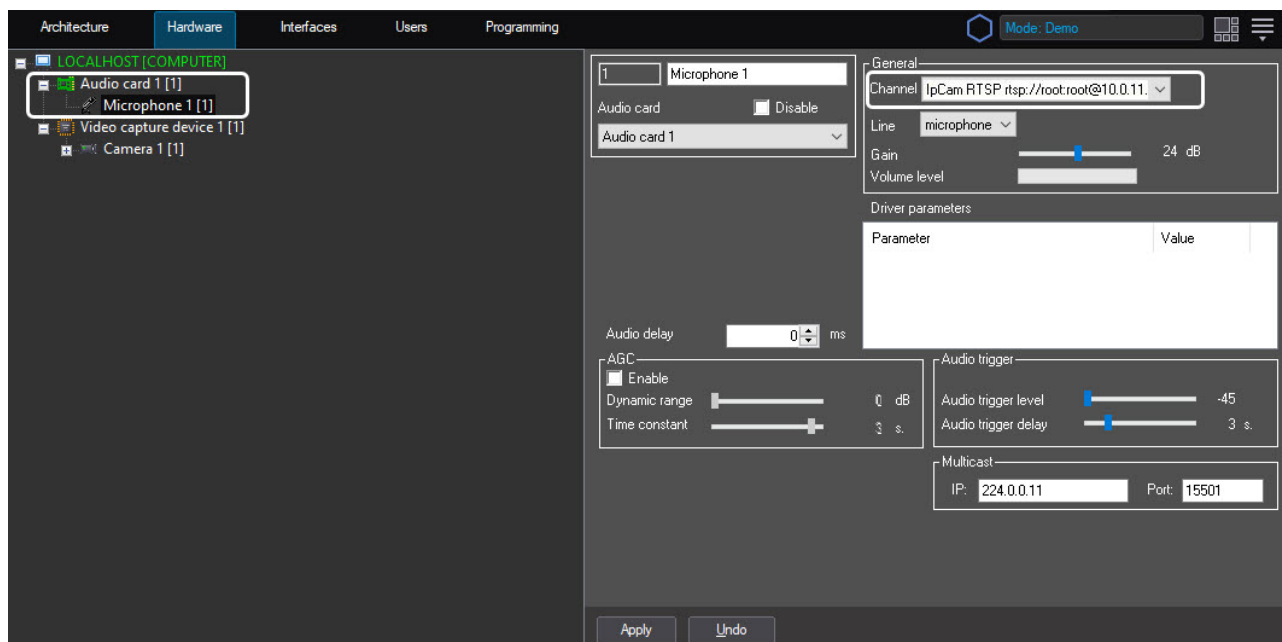

Further actions with received audio stream are performed using the created **Microphone** object.

Connecting cameras via the GB/T28181 protocol

On the page:

- [General information on GB/T28181 standard and supported functions](#)
- [Configuring an IP-device to operate via GB/T28181 standard](#)
- [Configuring IP-device connection via GB/T28181](#)

General information on GB/T28181 standard and supported functions

Axxon PSIM supports connecting devices via the Chinese standard GB/T28181. This standard is based on SIP over UDP (and over TCP since GB/T28181-2016). The GB/T28181 uses the following protocols over SIP:

- SDP (Session Description Protocol)

- MANSCDP (Monitoring and Alarming Network System Control Description Protocol)
- MANSRTSP (Monitoring and Alarming Network System Real Time Streaming Protocol)

This allows receiving the status of sensors, events from detectors, PTZ and relays control, access the built-in archive of the IP device (make sure to set the correct device time zone in the *Axxon PSIM*), etc. within the SIP session. Single-channel and multi-channel devices in single-stream mode and working with the UDP and TCP transport protocols is also supported.

At the same level of the OSI model, the RTP/RTCP protocol also works in parallel with the SIP protocol, which makes it possible to use the following functions:

- Video transmission (including archival) in H264, H265, or MJPEG format.
- Audio transmission in G.711a, G.711u, or G.726 format in PS (Program Stream) only. Archive audio is not supported.

For the most up-to-date information on this standard and the features supported in *Axxon PSIM*, see the [Documentation Drivers Pack](#).

Configuring an IP-device to operate via GB/T28181 standard

Configuration of IP devices connected via GB/T28181 is performed through the web interface of the devices. Settings are not sent from *Axxon PSIM* to the device.

Before connecting a camera via this protocol to *Axxon PSIM*, perform the following steps to configure SIP on the device:

1. Set the Server IP to equal the Server's IP address.
2. Set the Server port (5060 by default).
3. Set the Device ID. The ID should be set on all cameras connected via the GB/T28181 protocol and must be unique. The format of the connection code (device ID and server ID) is a 20-digit number:
 - a. the first 10 digits specify the address (according to the GB/T-2260-2007 standard);
 - b. the next 10 digits indicate device information.

If the IP device is located behind NAT, then forward and explicitly specify the external address of the Server, the port/port range for receiving video, and the SIP port of *Axxon PSIM* Server. Example:
3402000001110000001/50557-51557@10.3.3.11/85.172.174.36
4. For the device to perform autodiscovery of the Server more quickly, reduce the default value of RefreshRegTime. The name of this setting may vary on some cameras.

 **Note.**

For telemetry to work correctly, set RefreshRegTime to more than 600.

See also [Examples of IP device settings for connection via GB/T28181 standard](#).

Configuring IP-device connection via GB/T28181

 **Important!**

No more than one SIP server can be used for IP devices connection via the GB/T28181 protocol. This means that several **Video Capture Device** objects with **GBT28181** type can be created in the *Axxon PSIM* hardware tree, however, the part of the address after @ must match for all of them. The server ID, local address, external address, and port must be the same for all devices. If at least one parameter is different (for example, the local IP address is not set for some device when it is set for other devices), then such a device will not start.

Note.

Axxon PSIM does not support auto-discovery of devices connected via GB/T28181 and these devices are not added using the Camera discovery tool.

After configuring the device as described earlier, add it to *Axxon PSIM* as follows:

1. Go to the **Hardware** tab of the **System settings** dialog box (1).

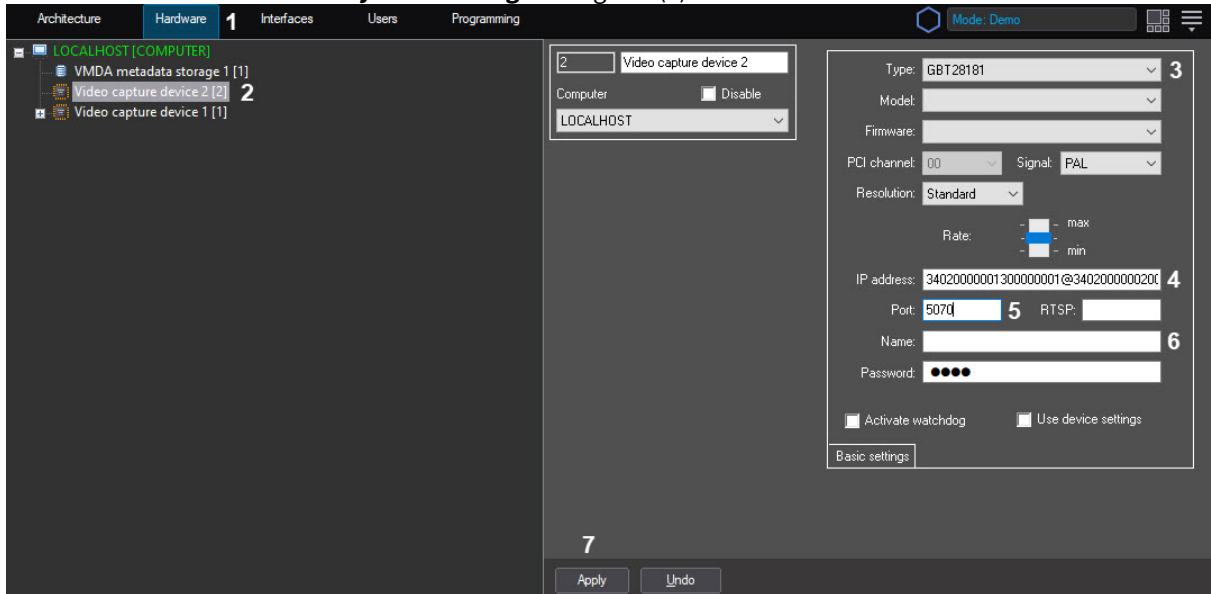

2. Create a **Video Capture Device** object under the **Computer** object (2). The settings panel of the object appears on the right of the **System settings** dialog box.
3. Select the **GBT28181** value in the **Type** dropdown list (3).
4. In the **IP** field specify the value of Device ID parameter set during IP device configuration (4). The following additional parameters can be specified optionally as follows:

[gbt://]deviceID[/videoPort]@serverID[-serverLocalIP[/serverExternalIP]]

OR

[gbt://]deviceID[/videoPortFirst-videoPortLast]@serverID[-serverLocalIP[/serverExternalIP]]

where:

deviceID is the Device ID parameter;

serverID is the identifier of the *Axxon PSIM* Server generated according to the same rules as the IP device ID (see above);

videoPort is the port for receiving video;

videoPortFirst-videoPortLast is range of ports for receiving video;

serverLocalIP is the local IP address of the *Axxon PSIM* Server, which sets the network interface on which the Server should be available;

serverExternalIP is the global IP address of the *Axxon PSIM* Server; this parameter is in use when the *Axxon PSIM* Server is behind the gateway. In this case, this IP address is specified as the SIP Server IP address in the IP device settings.

Examples.

34020000001320000008@34020000002000000001

34020000001320000008@34020000002000000001-10.0.40.246/113.125.160.58

34020000001320000008@34020000002000000001-10.0.40.246

34020000001320000008@34020000002000000001-/113.125.160.58

```
34020000001320000008/50200@34020000002000000001
34020000001320000008/50200-50210@34020000002000000001-10.0.40.246
```

- In the **Port** field, enter the local port number that the Axxon PSIM Server shall listen for receiving messages from the IP device (5). Usually this is the default SIP port: 5060.

Note.
The IP device SIP port is detected automatically.

- The **Name** and the **Password** fields are not used.
- Click the **Apply** button (7).
- Create a **Camera** object under the **Video Capture Device** object. The settings panel of the object appears on the right of the **System settings** dialog box.

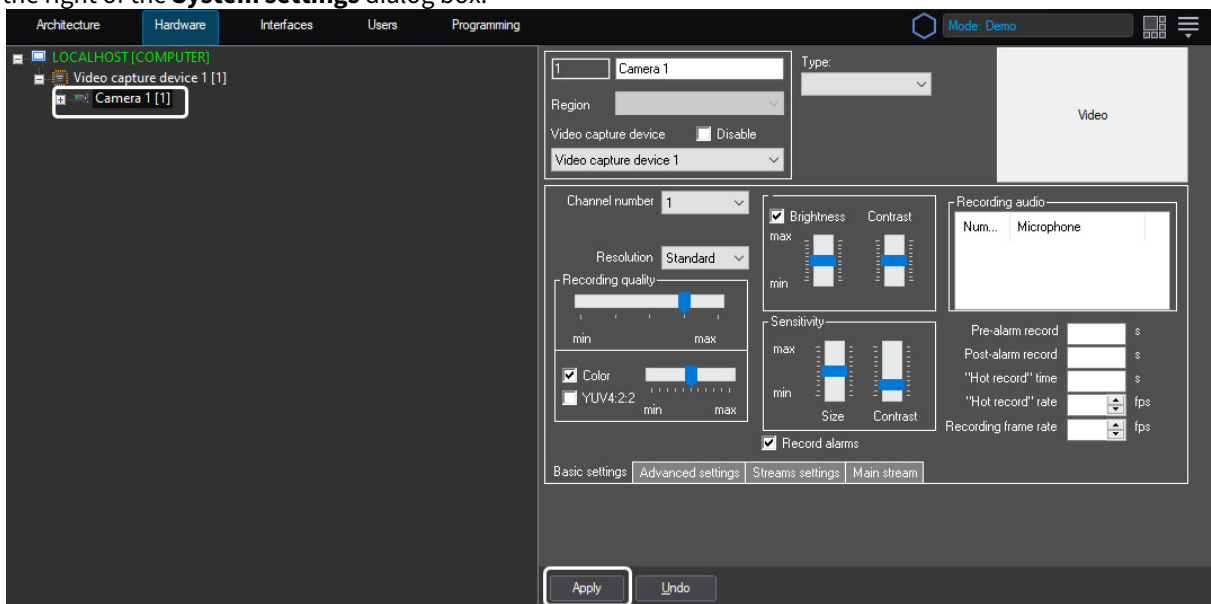

- Click the **Apply** button.

Further functioning of the device (e.g. displaying video on the Video Surveillance Monitor, archive recording) is performed using the created **Camera** object – see [Configuring video subsystem](#) section of [Administrator's Guide](#). The PTZ and relay management functions, access to the built-in storage, etc. are configured in the same manner as for ordinary IP devices as described in the corresponding sections [herein](#).

A camera via GB/T28181 protocol is now added.

Examples of IP device settings for connection via GB/T28181 standard

On the page:

- [Jovision](#)
- [Bosch](#)
- [Huawei](#)

- Hikvision
 - GB/T28181-2011
 - GB/T28181-2016
 - Settings in Axxon PSIM
- Dahua

Examples of IP device settings and connection settings in *Axxon PSIM* for GB/T28181 standard are given below. The protocol is usually supported by cameras for China market not having any English interface. This is why some of the screenshots below are given in Chinese.

Jovision

Configure a Jovision camera for operation via GB/T28181 standard as follows:

1. Perform the following settings of the IP-device:
 - a. Go to the IP device web interface (see [How to call the Web Server home page of IP device](#)).
 - b. Enter your login and password.



- c. Click **确定** (Confirm) in the dialog box opened.



- d. Click **设备设置** (Device settings).

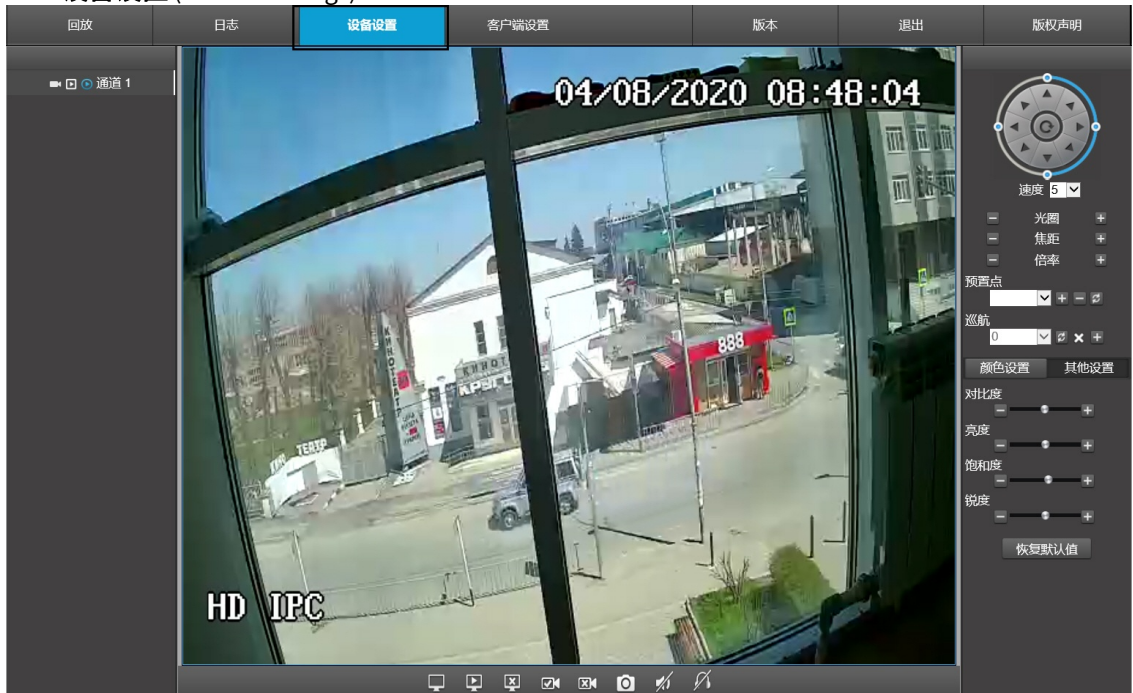

- e. Select **Network** in the dialog box.

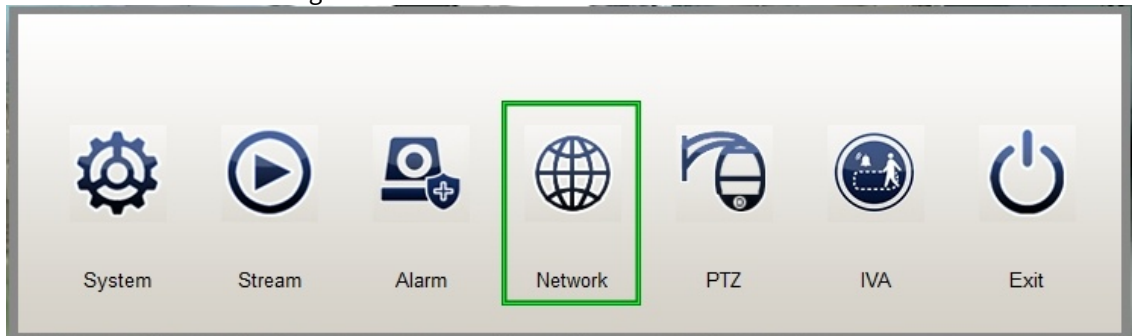

f. In the **Network Management** window, click **GB28181**.

g. The **GB28181** window opens.

- h. Set the **Gb28181 Enable** checkbox checked (1).
- i. In the **Device ID** field, enter the device identification number as described in [Connecting cameras via the GB/T28181 protocol](#) (2). Example on the picture shows Device ID **34020000001300000001**.
- j. In the **Server Ip** field, enter the *Axxon PSIM* server IP-address (3). The example shows IP **179.17.12.2**
- k. In the **Server Port** field, enter *Axxon PSIM* server port number assigned for receiving messages from the IP device (4) The example shows port **5070**.
- l. In the **Local Port** field, enter the IP device SIP port number (5).

- m. In the **Refresh Interval** field, enter the device discovery period in seconds (6). The value shall not be less than 600.
- n. In the **Keep Alive** field, enter the period in seconds for sending messages confirming the device activity (7).
- o. Click the **Ok** button (8).
2. Use the following settings for the **Video capture device** object in *Axxon PSIM*:
 - a. Select **GBT28181** from the **Type** drop-down list.
 - b. Example value for the **IP address** field:
`340200000130000001@340200000130000002-10.0.40.246/179.17.12.2`
 The Server ID 340200000130000002 is not set on the Jovision device, so any Server ID can be chosen as per the conditions set in [Connecting cameras via the GB/T28181 protocol](#).
 - c. Set **Port** to **5070**.

Bosch

Configure a Bosch camera for operation via GB/T28181 standard as follows:

1. Perform the following settings of the IP-device:
 - a. Go to the IP device web interface (see [How to call the Web Server home page of IP device](#)).
 - b. Go to **Configuration - General - GB/T 28181**.

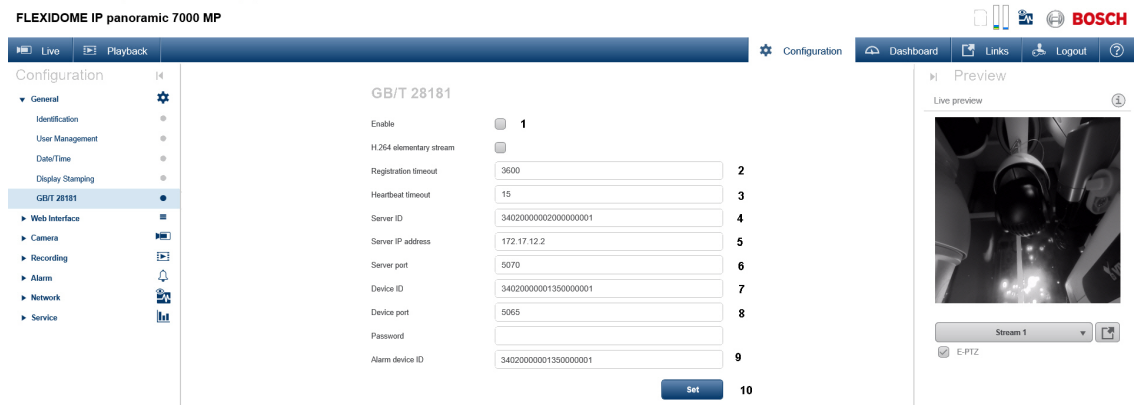

- c. Set the **Enable** checkbox checked (1).
- d. In the **Registration timeout** field, enter the device discovery period in seconds (2). The value shall not be less than 600.
- e. In the **Heartbeat timeout** field, enter the period in seconds for sending messages confirming the device activity (3).
- f. In the **Server ID** field, enter the *Axxon PSIM* server identification number (4). The example shows `3402000001300000001`.
- g. In the **Server IP address** field, enter the *Axxon PSIM* server IP-address (5). The example shows `172.17.12.2`
- h. In the **Server port** field, enter *Axxon PSIM* server port number assigned for receiving messages from the IP device (6). The example shows port **5070**.
- i. In the **Device ID** field, enter the device identification number as described in [Connecting cameras via the GB/T28181 protocol](#) (7). Example on the picture shows Device ID `3402000001350000001`.
- j. In the **Device port** field, enter the IP device SIP port number (8).
- k. In the **Alarm device ID** field, enter the channel identification number (9). The same value as **Device ID** may be used.
- l. Click the **Set** button (10).
2. Use the following settings for the **Video capture device** object in *Axxon PSIM*:
 - a. Select **GBT28181** from the **Type** drop-down list.
 - b. Example value for the **IP address** field:
`3402000001350000001@340200000130000001-10.0.40.246/172.17.12.2`

- c. Set **Port** to **5070**.

Huawei

Configure a Huawei camera for operation via GB/T28181 standard as follows:

1. Perform the following settings of the IP-device:
 - a. Go to the IP device web interface (see [How to call the Web Server home page of IP device](#)).
 - b. Go to **Settings - Platform connections - Second Protocol Parameters - T28181**.

The screenshot shows the 'Settings' page of a Huawei IPC. The 'Second Protocol Parameters' section is expanded, showing the 'GB/T 28181' configuration. The 'Enable media stream keep-alive' checkbox is checked. The 'Platform IP' field is set to '10.2.2.107', 'Port number' is '5070', 'Device ID' is '3402000001110000001', 'Server code' is '3402000002000000001', 'Login name' is '3402000001110000001', and 'Password' is '3402000000'. On the right, 'Registration validity (s)' is '3600', 'Heartbeat cycle (s)' is '60', 'Max number of timeouts' is '3', 'Stream index' is 'Secondary 1', 'Channel ID' is '3402000001320000000', 'Alarm input ID' is 'Alarm in*', and 'Alarm output ID' is 'Alarm out*'. A 'Save' button is at the bottom.

- c. Set the **GB/T 28181** checkbox checked (1).
 - d. In the **Platform Ip** field, enter the *Axxon PSIM* server IP-address (2). The example shows **10.2.2.107**
 - e. In the **Port number** field, enter *Axxon PSIM* server port number assigned for receiving messages from the IP device (3). The example shows port **5070**.
 - f. In the **Device ID** field, enter the device identification number as described in [Connecting cameras via the GB/T28181 protocol](#) (4). Example on the picture shows Device ID **3402000001110000001**.
 - g. In the **Server code** field, enter the *Axxon PSIM* server identification number (5). The example shows Server ID **3402000002000000001**.
 - h. In the **@** field, enter the first 10 digits of the address according to GB/T-2260-2007 (6).
 - i. In the **Registration validity (s)** field, enter the device discovery period in seconds (7). The value shall not be less than 600.
 - j. In the **Heartbeat cycle (s)** field, enter the period in seconds for sending messages confirming the device activity (8).
 - k. In the **Max number of timeouts** field, enter the maximum number of Heartbeat message omissions after which the device connection is considered lost (9).
 - l. Select the video stream from the **Stream index** drop-down list (10).
 - m. In the **Channel ID** field, enter the channel identification number in the same format as Device ID and Server ID (11).
 - n. Click the **Save** button (12).
2. Use the following settings for the **Video capture device** object in *Axxon PSIM*:
 - a. Select **GBT28181** from the **Type** drop-down list.
 - b. Example value for the **IP address** field: **3402000001110000001@3402000002000000001-10.2.2.107**
 - c. Set **Port** to **5070**.

Hikvision

The Hikvision cameras may support several GB/T28181 standard versions: GB/T28181-2011 and/or GB/T28181-2016. Examples of configuration for these versions are given below.

Setup video streams as follows before you configure the GB/T28181 standard on the IP device:

1. Go to **配置 - 视音频 - 视频** (Settings - Video and Audio - Video).

2. Configure the main stream:

- a. From the **码流类型** (Stream type) drop-down list, select **主码流 (定时)** (Main stream) (1).



- b. From the **分辨率** (Resolution) drop-down list, select the main stream resolution (2).

- c. From the **视频编码** (Codec) drop-down list, select the main stream codec (3).

3. Configure the second stream:

- a. From the **码流类型** (Stream type) drop-down list, select **子码流** (Second stream) (1).



- b. From the **分辨率** (Resolution) drop-down list, select the second stream resolution (2).

- c. From the **视频编码** (Codec) drop-down list, select the second stream codec (3).

4. Click **保存** (Save).

GB/T28181-2011

- Go to **配置 - 高级设置 - 平台接入** (Settings - Advanced settings - Platform access).

SNMP	FTP	Email	平台接入	HTTPS	QoS	802.1x	集成协议	网络服务
			平台接入方式	28181				
			本地SIP端口	5060	✓			
			传输协议	UDP				
			白名单	编辑				
			平台1					
			<input checked="" type="checkbox"/> 启用 1					
			协议版本	GB/T28181-2011	2			
			SIP服务器ID	34020000002000000001	3	✓		
			SIP服务器域	3402000000	4	✓		
			SIP服务器地址	109.248.191.112	5	✓		
			SIP服务器端口	5070	6	✓		
			SIP用户名	34020000001320000001	7	✓		
			SIP用户认证ID	172171289		✓		
			密码	•••••				
			密码确认	•••••				
			注册有效期	3600	8	✓ 秒		
			注册状态	在线				
			心跳周期	60	9	✓ 秒		
			28181码流索引	主码流 (定时)	10			
			最大心跳超时次数	3	11	✓		

- Set the **启用** (Enable) checkbox (1).
- From the **协议版本** (Protocol version) drop-down list, select **GB/T28181-2011** (2).
- In the **SIP服务器ID** (SIP Server ID) field, enter the *Axxon PSIM* Server ID (3). The example shows Server ID **34020000002000000001**.
- In the **SIP服务器域** (SIP Server domain) field, enter first 10 digits of the address according to GB/T-2260-2007 (4).
- In the **SIP服务器地址** (SIP Server address) field, enter the *Axxon PSIM* server IP-address (5). The example shows IP **109.248.191.112**.
- In the **SIP服务器端口** (SIP Server Port) field, enter the *Axxon PSIM* server port number assigned for receiving messages from the IP device (6). The example shows port **5070**.
- In the **SIP用户名** (SIP user name) field, enter the device identification number as described in [Connecting cameras via the GB/T28181 protocol](#) (7). Example on the picture shows Device ID 34020000001320000001.
- In the **注册有效期** (Registration period) field, enter the device discovery period in seconds (8). The value shall not be less than 600.
- In the **心跳周期** (Heartbeat period) field, enter the period in seconds for sending messages confirming the device activity (9).
- From the **28181码流索引** (Video stream) drop-down list, select one of the streams configured earlier (**主码流 (定时)** for Main stream or **子码流** for Second stream) (10).
- In the **最大心跳超时次数** (number of timeouts for Heartbeat messages) field, enter the maximum number of Heartbeat message omissions after which the device connection is considered lost (11).

13. Go to the **视频通道编码ID** (Video channel ID) tab at the bottom of the settings page (1).

编码ID

报警输入编码ID **视频通道编码ID** 语音输出通道编码ID

通道号	1	视频通道编码ID
1		34020000001320000002
		2



14. Enter the identifiers of all channels of the IP device in the same format as the device identifiers (2). The example shows ID **34020000001320000002**.

15. Click the **保存** (Save) button (3).

GB/T28181-2016

- Go to **配置 - 高级设置 - 平台接入** (Settings - Advanced settings - Platform access).

The screenshot displays the '平台接入' (Platform Access) configuration page in the Hikvision web interface. The page is divided into a left sidebar with navigation options and a main configuration area. The configuration area includes fields for platform access mode, local SIP port, transport protocol, and a list of platforms. The '平台1' (Platform 1) section is expanded, showing a '启用' (Enable) checkbox and various SIP server parameters such as protocol version, server ID, domain, address, port, username, authentication ID, password, registration period, registration status, heartbeat period, 28181 code flow index, registration interval, and maximum heartbeat timeout. Each field has a corresponding number (1-13) indicating the step in the configuration process.

- From the **传输协议** (Transport protocol) drop-down list, select the transport level protocol to be in use: UDP or TCP (1).
- Set the **启用** (Enable) checkbox (2).
- From the **协议版本** (Protocol version) drop-down list, select **GB/T28181-2016** (3).
- In the **SIP服务器ID** (SIP Server ID) field, enter the *Axxon PSIM* Server ID (4). The example shows Server ID **3402000002000000001**.
- In the **SIP服务器域** (SIP Server domain) field, enter first 10 digits of the address according to GB/T-2260-2007 (5).
- In the **SIP服务器地址** (SIP Server address) field, enter the *Axxon PSIM* server IP-address (6). The example shows IP **109.248.191.112**.
- In the **SIP服务器端口** (SIP Server Port) field, enter the *Axxon PSIM* server port number assigned for receiving messages from the IP device (7). The example shows port **5070**.
- In the **SIP用户名** (SIP user name) field, enter the device identification number as described in [Connecting cameras via the GB/T28181 protocol](#) (8). Example on the picture shows Device ID **3402000001320000001**.
- In the **注册有效期** (Registration period) field, enter the device discovery period in seconds (9). The value shall not be less than 600.
- In the **心跳周期** (Heartbeat period) field, enter the period in seconds for sending messages confirming the device activity (10).

12. From the **28181码流索引** (Video stream) drop-down list, select one of the streams configured earlier (**主码流 (定时)** for Main stream or **子码流** for Second stream) (11).
13. In the **注册间隔** (Registration interval) field, enter the device discovery interval in seconds (12).
14. In the **最大心跳超时次数** (number of timeouts for Heartbeat messages) field, enter the maximum number of Heartbeat message omissions after which the device connection is considered lost (13).
15. Go to the **视频通道编码ID** (Video channel ID) tab at the bottom of the settings page (1).

编码ID

报警输入编码ID	1	语音输出通道编码ID
通道号	1	视频通道编码ID
	1	34020000001320000002
		2

保存 3

16. Enter the identifiers of all channels of the IP device in the same format as the device identifiers (2). The example shows ID **34020000001320000002**.
17. Click the **保存** (Save) button (3).

Settings in Axxon PSIM

Use the following settings for the **Video capture device** object in *Axxon PSIM*:

1. Select **GBT28181** from the **Type** drop-down list.
2. Example value for the **IP address** field: **34020000001320000001@3402000000200000001-109.248.191.112**
3. Set **Port** to **5070**.

Dahua

Configure a Dahua camera for operation via GB/T28181 standard as follows:

1. Perform the following settings of the IP-device:
 - a. Go to the IP device web interface (see [How to call the Web Server home page of IP device](#)).
 - b. Go to **网络设置 - 平台接入 - 国标28181** (Network settings - Platform access - GBT28181).

- c. Set the **接入使能** (Enable connection) checkbox (1).
- d. In the **SIP服务器编号** (SIP server number) enter the Axxon PSIM Server ID (2). The example shows Server ID **34020000002000000001**.
- e. In the **SIP服务器IP** (SIP server IP address) enter the Axxon PSIM server IP address (3). The example shows IP **192.168.88.33**

- f. In the **设备编号** (Device number) field, enter the device identification number as described in [Connecting cameras via the GB/T28181 protocol](#) (4). Example on the picture shows Device ID **34020000001300000001**.
 - g. In the **本地SIP服务器端口** (Local SIP port) field, enter the IP device SIP port number (5).
 - h. In the **心跳周期** (Heartbeat period) field, enter the period in seconds for sending messages confirming the device activity (6).
 - i. In the **SIP服务器端口** (SIP server port) field, enter the Axxon PSIM server port assigned for receiving messages from the IP device (7). The example shows port **5060**.
 - j. In the **注册有效期** (Registration period) field, enter the device discovery period in seconds (8). The value shall not be less than 600.
 - k. In the **最大心跳超时次数** (number of timeouts for Heartbeat messages) field, enter the maximum number of Heartbeat message omissions after which the device connection is considered lost (9).
 - l. Click **刷新** (Update).
2. Use the following settings for the **Video capture device** object in *Axxon PSIM*:
 - a. Select **GBT28181** from the **Type** drop-down list.
 - b. Example value for the **IP address** field: **34020000001300000001@34020000002000000001-192.168.88.33**
 - c. Set **Port** to **5060**.

Connecting devices via FFMPEG driver

The FFMPEG general-purpose driver has the following features:

- receiving video and audio over RTSP or RTMP protocols via FFMPEG driver;
- playing back video and audio in any format supported by ffmpeg (FFmpeg);
- playing back video and audio from connected cameras and microphones in the selected format (compressed/

not compressed stream, resolution, codec, bitrate, etc.)

The following device types (models) are supported:

- **1 channel device** for receiving video and audio over RTSP or RTMP protocols via FFMPEG driver.
- **Dshow device (USB camera)** for receiving video and audio from a USB web camera.
- **Desktop capturer** for grabbing video image from all Server displays/monitors in MJPEG (by default). The grabbing with decompression to YUV is also supported.
- **Windows capturer** for grabbing video image from application window.

See sections below for details on each of these device types of configuration.

Receiving video and audio over RTSP or RTMP protocols via FFMPEG driver

On the page:

- [Creating the Video capture device object](#)
- [Additional options for the FFMPEG device](#)

- [Connecting multistream devices](#)

The **Video capture device** object for receiving video and audio over RTSP or RTMP protocols via FFMPEG driver can be added either by [manually creating the Video capture device](#) or using the [Camera discovery tool](#). The latter way is preferable.

Note.

Receiving video and audio over RTSP or RTMP protocols via FFMPEG driver has the following restrictions:

- One stream per channel is supported only. See the “Connecting multistream devices” section below for details on configuration of the multistream devices.
- Video is received with 264/H.265 codecs only.
- Audio is received with AAC codec only.

Creating the Video capture device object

In order to add the **Video capture device** object to receive video and audio over RTSP or RTMP protocols via FFMPEG driver, proceed as follows:

1. Start the [Camera discovery tool](#).

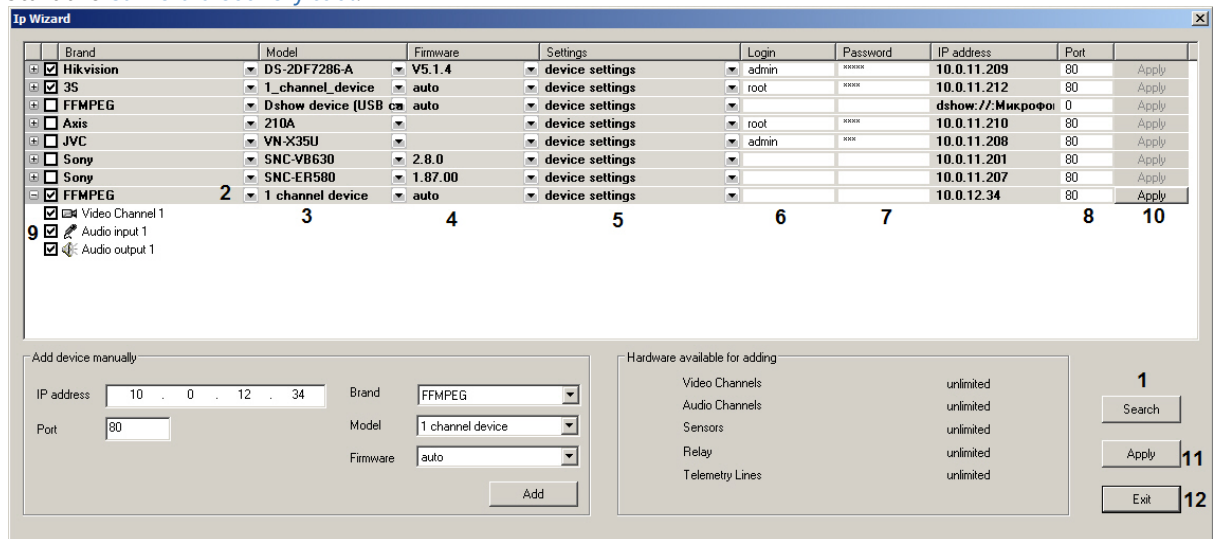

2. The found FFMPEG devices are shown in the list. If the required device is not displayed, click **Search** (1) and wait for re-discovery finishes. Check that the (2) list shows **FFMPEG**, the (3) list shows **1 channel device**, and the (4) list is set to **auto**. Change the values if necessary by opening the drop-down list selecting the proper value.
From the drop-down list (5) select settings which should be installed on the IP-device while its adding to the device tree: leave installed **device settings** or apply *Axxon PSIM video server settings*.
3. Specify the login (6) and password (7) to connect FFMPEG device. Login and password are specified in the documentation for connected network device.

Note.

You can set the login and password directly in the **IP address** field on the **Video capture device** object settings panel. If the login and password are set simultaneously in the address field and in the corresponding fields, the address field setting are applied.

4. Check if the TCP/IP port is configured correctly (8). Enter the proper value if necessary.

Note.
You can set the port directly in the **IP address** field on the **Video capture device** object settings panel.

5. Select the objects to be created under the FFMPEG device by setting the corresponding checkboxes (9, see [Camera discovery tool](#) for details).
6. Click **Apply** for one device (10) or (11) if several devices are selected. The selected objects are automatically created in the object tree on the **Hardware**
7. Click **Exit** to close the **IP Wizard** window (12).

If the FFMPEG device was not found, add it manually by [creating and configuring the Video capture device](#). The device address format is given in the “Additional options for the FFMPEG device” section below.

Additional options for the FFMPEG device

The additional options for the ffmpeg utility can be specified in the **IP address** field on the **Video capture device** object settings panel. In this case, the address has the following format:

protocol://[login:password@]address[:port][/path]:[-additional_options]

The list of possible options and their values depends on the format of the device and the protocol in use. For full list of options, e.g. for the rtsp protocol, please [refer to this page](#).

Example:

rtsp://admin:1111@59.124.126.102:84/ -video_size 1280x960

Connecting multistream devices

Indicate the stream number in the link in the **IP address** field using the bitmask in order to add a specific stream of a multithreaded device:

Channel No.	Number in the link
1	1
2	2
3	4
4	8
5	16
6	32

7	64
8	128

For example, if the video is transmitted by the link: `rtsp://admin:1111@59.124.126.102:84/cgi-bin/net_jpeg.cgi?push=1&ch=X`

then X is 2 to the power of the channel number, starting from channel zero (i.e. 1, 2, 4, 8, 16, ..., 32768)

Receiving video and audio from USB web camera via FFmpeg driver

On the page:

- [Creating the Video capture device object](#)
- [Additional options for the FFmpeg device](#)
- [Connecting multistream devices](#)

The **Video capture device** object for receiving video and audio from USB web camera via FFmpeg driver can be added either by [manually creating the Video capture device](#) or using the [Camera discovery tool](#). The latter way is preferable.

Using the FFmpeg driver for connecting USB web cameras has the following features:

- Video and audio streams are not combined for the discovered devices, so if there are USB camera with a microphone, 2 devices are shown – one video only and one audio only.
- In order to make a single device with both audio and video streams, edit the **IP address** field on the **Video capture device** object settings panel. Enter the name of the audio device after the name of the video device divided by the colon. See also [Additional options for the FFmpeg device](#) below.
- Both video and audio device may be absent, i.e. the device address may be like “`dshow://:Internal Microphone (Conexant ISST Audio)`” allowing to use the device without video but with audio.

Creating the Video capture device object

In order to add the **Video capture device** object to receive video and audio over RTSP or RTMP protocols via FFmpeg driver, proceed as follows:

1. Start the [Camera discovery tool](#).

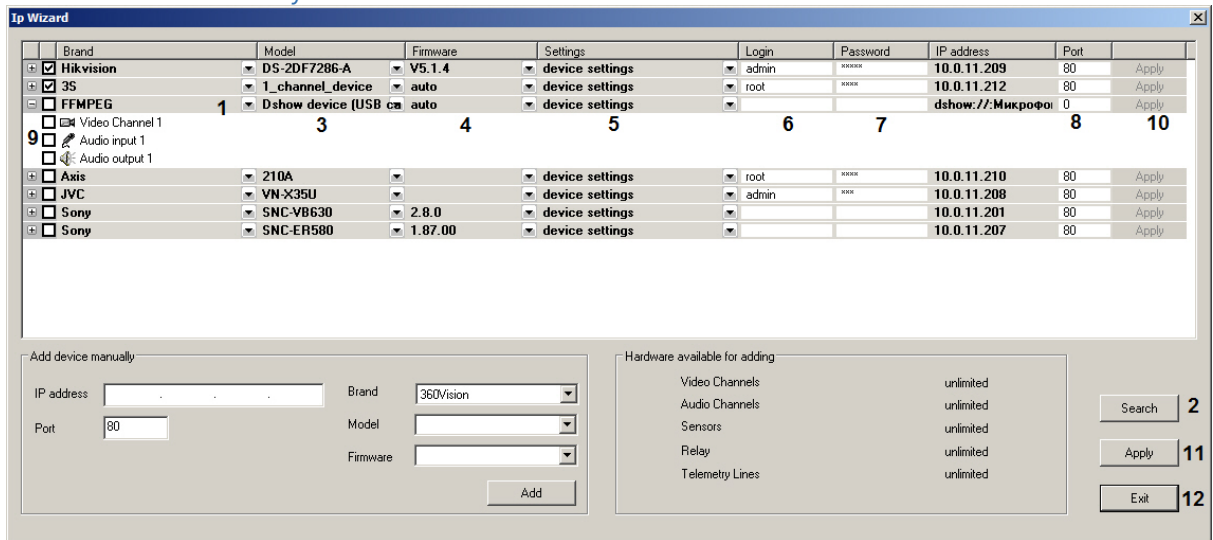

- The found FFMPEG devices are shown in the list. If the required device is not displayed, click **Search** (1) and wait for re-discovery finishes. Check that the (2) list shows **FFMPEG**, the (3) list shows **Dshow device (USB camera)**, and the (4) list is set to **auto**. Change the values if necessary by opening the drop-down list selecting the proper value. From the drop-down list (5) select settings which should be installed on the IP-device while its adding to the device tree: leave installed **device settings** or apply *Axxon PSIM video server settings*.
- Specify the login (6) and password (7) to connect FFMPEG device. Login and password are specified in the documentation for connected network device. These fields are usually left empty.
- Check if the TCP/IP port is configured correctly (8). Enter the proper value if necessary.
- Select the objects to be created under the FFMPEG device by setting the corresponding checkboxes (9, see [Camera discovery tool](#) for details).
- Click **Apply** for one device (10) or (11) if several devices are selected. The selected objects are automatically created in the object tree on the **Hardware**
- Click **Exit** to close the **IP Wizard** window (12).

If the FFMPEG device was not found, add it manually by [creating and configuring the Video capture device](#). The device address format is given in the “Additional options for the FFMPEG device” section below.

Additional options for the FFMPEG device

The additional options for the ffmpeg utility can be specified in the **IP address** field on the **Video capture device** object settings panel.

In this case, the address has the following format:

dshow[index]://[video_device_name]:[audio_device_name]: [-additional_options]

If the index is not specified explicitly, it is set to "0" by default (a non-zero index is used for cases when several devices with the same name are connected to the system at the same time, for example, "dshow1: // USB 2.0 HD Camera" is in use when "dshow: // USB 2.0 HD Camera" is already added).

For example, the required resolution and the output codec of the USB camera can be set (other than the default settings):

-pixel_format yuv420p -video_size 1280x960

The list of possible options and their values depends on the format and the device. Use the following command for command prompt to discover available values for dshow devices:

ffmpeg -list_options true -f dshow -i video="<device name>"

Connecting multistream devices

Two streams can be enabled for the camera created under the **Video capture device** object with **Dshow device (USB camera)** model and the following codecs are available for each of the streams:

- YUV422 – the codec for the detection stream.
- MJPEG – the codec for transmitting over the network and for saving to the archive. See also [Configuration of multistream video](#).

Grabbing video image from all Server displays/monitors via FFmpeg driver

On the page:

- [Configuring the system for capturing the system sound](#)
- [Creating the Video capture device and Audio card object](#)
- [Additional options for the FFmpeg device](#)

The **Video capture device** object for grabbing video image from all Server displays/monitors via FFmpeg driver can be added either by [manually creating the Video capture device](#) or using the [Camera discovery tool](#). The latter way is preferable.

The driver also supports capturing system sounds and sounds from the computer's microphone. Audio input and output format is PCM. The **Audio card** and **Microphone** objects should also be created and configured in addition to the **Video capture device** object in order to use this functionality. This can also be done using the Camera discovery tool. To capture system sounds, you configure the system accordingly (see below).

Configuring the system for capturing the system sound

In order to capture system sounds, enable the Stereo Mix device as follows:

1. Go to the **Recording** tab in the **Sound** window.

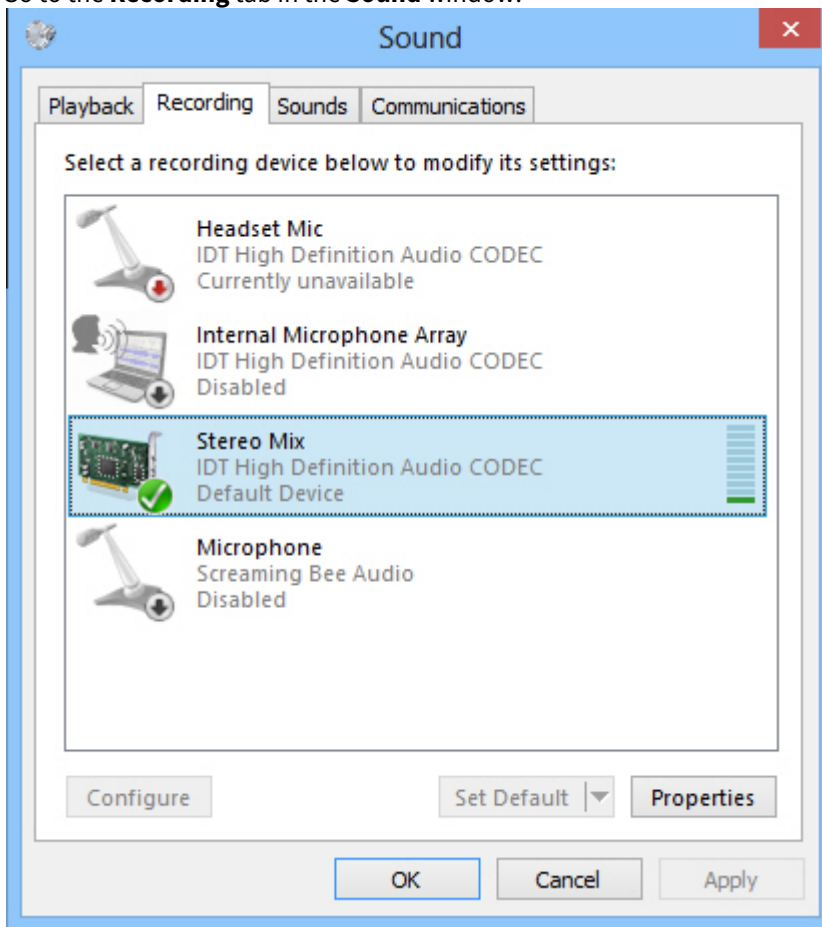

Note.



In Windows 7, in order to open this window, select **Recording Devices** in the menu that opens when you right-click the speaker icon.

2. If there is no **Stereo Mix** device on the **Recording** tab, right-click any empty space in the list and select **Show Disabled Devices**.
3. If the **Stereo Mix** device is disabled, right-click it and select **Enable**.
4. If the **Stereo Mix** device has any other name, rename it to "Stereo Mix" (case-sensitive); to do so, right-click the device then select **Properties** and enter the new name in the text field.
5. Click the **Apply** button in the **Sound** window.

Creating the Video capture device and Audio card object

Add the **Video capture device** object for grabbing video image from application windows and **Audio card** and **Microphone** objects for grabbing sounds via FFMPEG driver as follows:

1. Start the **Camera discovery tool**.

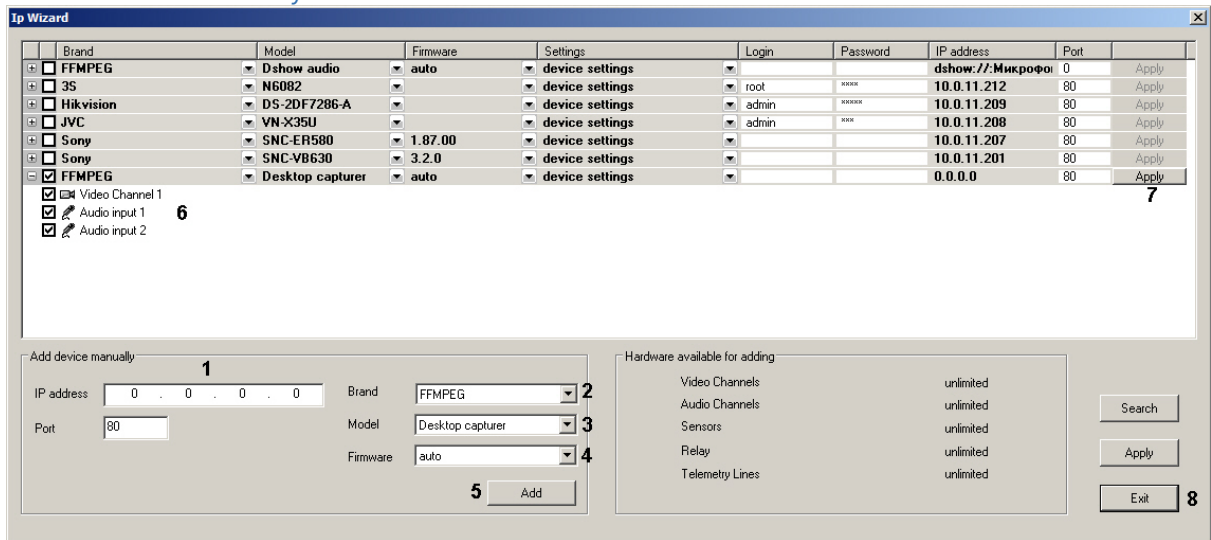

2. Enter any IP address in the **IP address** field (1). The driver automatically sets the proper address for this model.

Note. When adding this device type by manually creating the Video capture device object, set the following IP address: gdigrab://desktop

3. From the **Brand** drop-down list, select FFMPEG (2).
4. From the **Model** drop-down list, select **Desktop capturer** (3).
5. From the **Firmware** drop-down list, select auto (4).
6. Click **Add** (5). The device is added to the list.
7. Set the checkbox next to the added device and the child objects you need (6):
 - a. Select **Video channel** to capture video;
 - b. Select **Audio input 1** to capture audio from the speaker selected as the default output device in the system;
 - c. Select **Audio input 2** to capture audio from the microphone selected as the default device (not communication) in the system.

Important. The default microphone/speaker is defined when adding a **Video capture device** object. If you switch the default microphone/speaker (for example, by connecting a USB camera or microphone/speaker connector, or simply changing the system settings) after that without unloading *Axxon PSIM*, then switching to the new default device will NOT be performed automatically. To update the linked device, restart *Axxon PSIM* or delete the **Video capture device** and **Audio card** objects and re-add them.

8. Click **Apply** (7).
9. Click **Exit** (8).

Additional options for the FFMPEG device

The address with additional options for the ffmpeg utility can be specified in the **IP address** field on the **Video capture device** object settings panel. In this case, the address has the following format:

gdigrab://desktop: [-additionalOptions]

For example, a specific area can be set with several other options. Below is the list of options supported by the ffmpeg library for the gdirgrab mode:

- -draw_mouse <int> draw the cursor (0 or 1) (1 by default);
- -show_region <int> draw borders across the capture line (0 or 1) (0 by default);
- -framerate <video_rate> set frame rate ("ntsc" by default);
- -video_size <image_size> set frame size;
- -offset_x <int> indent along the x axis of the capture area (from INT_MIN to INT_MAX) (0 by default);
- -offset_y <int> indent along the y axis of the capture area (from INT_MIN to INT_MAX) (0 by default);

Example of "additionalOptions" property:

```
-draw_mouse 1 -show_region 1 -framerate 25 -video_size 640x480 -offset_x 10 -offset_y 10
```

Grabbing video image from application windows via FFMPEG driver

On the page:

- [Creating the Video capture device and Audio card object](#)
- [Additional options for the FFMPEG device](#)

The **Video capture device** object for grabbing video image from application windows via FFMPEG driver can be added either by [manually creating the Video capture device](#) or using the [Camera discovery tool](#). The latter way is preferable.

The [additional options](#) allow selecting the application window as well as adjusting the area and decompression parameters. Currently, the driver supports the following codecs: video capture in MJPEG (default) and RGBA/BGRA formats, decompression to MJPEG, MPEG2, YUV422.

Creating the Video capture device and Audio card object

Add the **Video capture device** object for grabbing video image from application windows and **Audio card** and **Microphone** objects for grabbing sounds via FFMPEG driver as follows:

1. Start the **Camera discovery tool**.

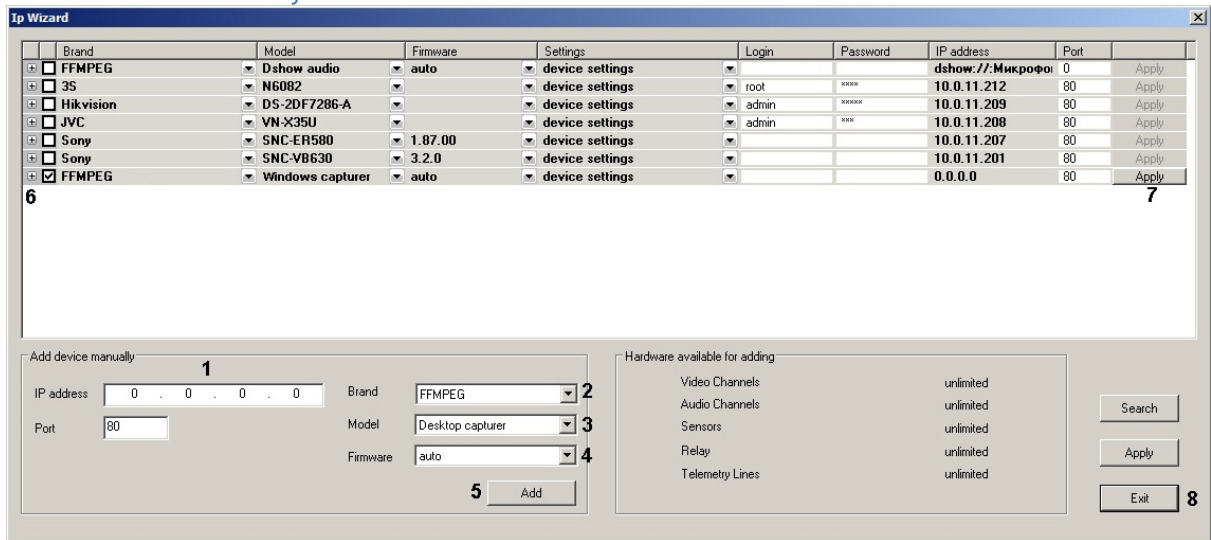

2. Enter any IP address in the **IP address** field (1). The driver automatically sets the proper address for this model.

Note.

When adding this device type by manually creating the **Video capture device** object, set the IP address as described in [Additional options for the FFmpeg device](#) subsection below.

3. From the **Brand** drop-down list, select FFmpeg (2).
4. From the **Model** drop-down list, select **Windows capturer** (3).
5. From the **Firmware** drop-down list, select auto (4).
6. Click **Add** (5). The device is added to the list.
7. Set the checkbox next to the added device (6).
8. Click **Apply** (7).
9. Click **Exit** (8).

Additional options for the FFmpeg device

The address with additional options for the ffmpeg utility can be specified in the **IP address** field on the **Video capture device** object settings panel. In this case, the address has the following format:

```
gdigrab://"App_name"[:-additionalOptions]
```

App_name is the name of the application that appears in the title bar of the window. The name must contain only Latin characters and/or digits. If there are any other symbols in the window title, use third party tools to change the title.

additionalOptions allow setting a specific area and several other options. Below is the list of options supported by the ffmpeg library for the gdigrab mode:

- -draw_mouse <int> draw the cursor (0 or 1) (1 by default);
- -show_region <int> draw borders across the capture line (0 or 1) (0 by default);
- -framerate <video_rate> set frame rate ("ntsc" by default);
- -video_size <image_size> set frame size;
- -offset_x <int> indent along the x axis of the capture area (from INT_MIN to INT_MAX) (0 by default);
- -offset_y <int> indent along the y axis of the capture area (from INT_MIN to INT_MAX) (0 by default);

Example of **IP address** field with "additionalOptions" property:

```
gdigrab://"Calculator":-draw_mouse 1 -show_region 1 -framerate 25 -video_size 640x480 -offset_x 10 -offset_y 10
```

Connecting devices via the ONVIF protocol

Axxon PSIM supports connecting devices via the ONVIF protocol.

Note.

In some cases (for example, if there is no video from the device), when connecting the camera using the ONVIF protocol, it may be necessary to synchronize the time and the time zone between the Server and the device in the web interface of the latter.

Note.

Set the `OnvifCompatibilityMode` registry key to 1 if the IP device does not support ONVIF fully – see [Registry keys reference guide](#).

Add an ONVIF device in *Axxon PSIM* as follows:

1. Open [Camera discovery tool](#).

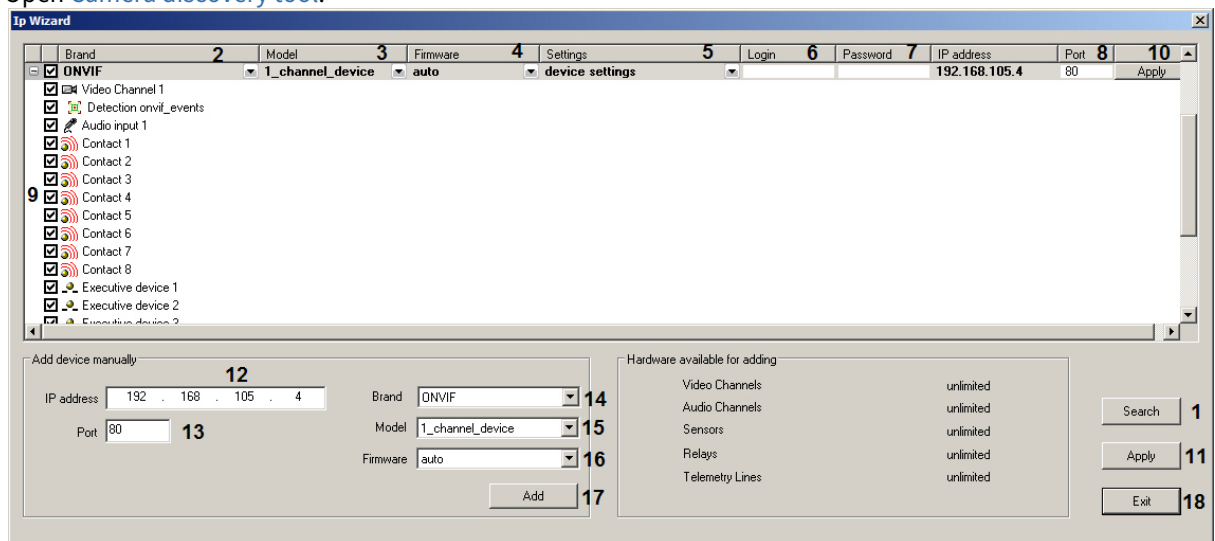

2. The discovered ONVIF devices appear in the list. If the required device is not in the list, try clicking **Search** (1) and wait for device rediscovering. Verify ONVIF or ONVIF 2.X are displayed in the list (2), the correct number of channels for the discovered device is in the list (3) and **auto** (4) in the **Firmware** list. Enter the required value if necessary (by opening the corresponding dropdown list). If the **general device** is indicated in the list (3), then after you click on the + icon, the device type will be automatically detected, and the number of device channels will be displayed in the list (2).
3. Select **videosever settings** in the dropdown list (5) if settings applied in *Axxon PSIM* are to be sent to the camera when it is added or select **device settings** if they are to be in use.
4. Enter the user name (6) and password (7) to connect an ONVIF device. The user name and password are given in the documentation for the connected device.
5. Verify the TCP/IP port is correct (8). Enter the required value if necessary.
6. Select the objects that are to be created under an ONVIF device by setting the corresponding check boxes checked (9) – see details in [Camera discovery tool](#).

7. Click the **Apply** button (10) for one device or (11) if several devices are selected.
The selected objects are automatically created in the object tree in the **Hardware** tab.
8. If an ONVIF device has not been discovered, add it manually.
1. Enter the device IP address in the **IP address** field (12).
2. Enter TCP/IP port number in the **Port** field (13).
3. Select ONVIF or ONVIF 2.X in the **Brand** list (14).

Note.

Select ONVIF 2.X and 1-channel-multistream to use multistream via ONVIF protocol. Video streams of connected ONVIF device are configured in a standard way (see [Configuration of multistream video](#) section of [Administrator's Guide](#)).

4. Select the number of device channels in the **Model** list (15).
5. Select **auto** in the **Firmware** dropdown list (16).
6. Click the **Add** button (17).
 - As a result, the ONVIF device with specified parameters appears at the top of the window.
 - To complete creation of ONVIF devices perform steps 2-6 as described above.
 - Click the **Exit** button to close the **IP Wizard** (18).

An ONVIF device is now created.

Using Generic Drivers (General device, generic)

General Device is a generic driver that supports nearly all devices from a particular camera vendor.

There are 2 types of generic drivers:

1. **General device.** Most configuration of General Device-connected cameras is performed via the web interface of the device. A detailed list of supported features is given on the [Documentation Drivers Pack](#) page.
2. **generic.** When connected via a generic driver, the configuration of the device is read and transferred to *Axxon PSIM*. After that, you can configure the device from within *Axxon PSIM*.

Connection via generic drivers is available for the following devices:

	Axis	Bosch	Panasonic	Samsung	Sony	ONVIF
General Device	+	+	+	+	+	-
generic	+	+	-	-	-	+

Add a General Device in *Axxon PSIM* as follows:

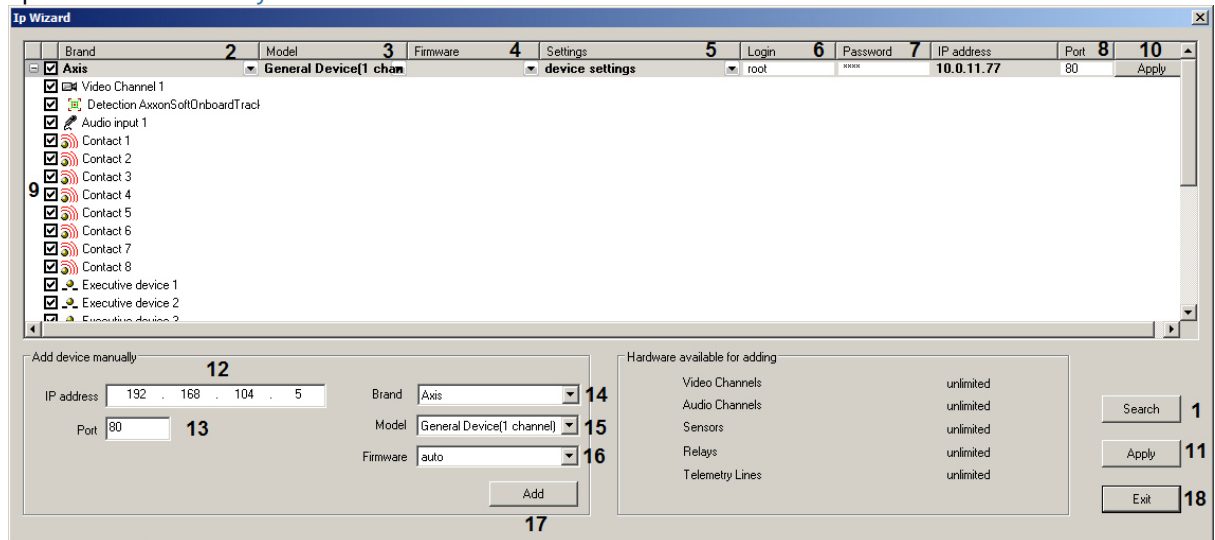
1. Open [Camera discovery tool](#).

- The discovered devices appear in the list. If the required device is not in the list, try clicking **Search** (1) and wait for device rediscovering. Verify the brand has been discovered correctly (2) and make sure that **General Device** or **generic** is specified in the **Model** list (3) and **auto** (4) in the **Firmware** list. Verify the number of channels on Axis and Bosch devices is correct.

Note.

Axis devices are affected by a special restriction: if the user name and password for device access do not equal the default values, the number of channels for the device is not discoverable. Therefore, all non-integrated devices whose user name and password for device access do not equal the default values will be shown in search results as 1-channel General Devices.

- Select **videosever settings** in the dropdown list (5) if settings applied in *Axxon PSIM* are to be sent to the camera when it is added or select **device settings** if they are to be in use. Keep in mind that settings are changed in the device's web interface.
- Enter the user name (6) and password (7) to connect an IP device. The user name and password are given in the documentation for the connected device.
- Verify the TCP/IP port is correct (8). Enter the required value if necessary.
- Select the objects that are to be created under an IP device by setting the corresponding check boxes checked (9) – see details in [Camera discovery tool](#).
- Click the **Apply** button (10) for one device or (11) if several devices are selected. The selected objects are automatically created in the object tree in the **Hardware** tab.
- If an IP device has not been discovered, add it manually.
 - Enter the device IP address in the **IP address** field (12).
 - Enter TCP/IP port number in the **Port** field (13).
 - Select the brand in the **Brand** list (14).
 - In the **Model** field, select **General Device** or **generic**. For Axis and Bosch devices, select the number of channels on the device (15).
 - Select **auto** in the **Firmware** dropdown list (16).
 - Click the **Add** button (17).
- As a result, the IP device with specified parameters appears at the top of the window.
- To complete creation of IP devices, perform steps 2-6 as described above.
- Click the **Exit** button to close the **IP Wizard** (18).

A General Device is now created.

3.2.7 Features of IP device configuration

Features of Beward IP cameras configuration

By default, port 80 is set for connecting to IP devices on the settings panel of the **Video Capture Device** object. Enter the **5000** value in the **Port** field to connect to IP device of Beward B-9xx series and B-10xx series (B-975W, B-970, B-915, B2.920, B-1070, B-1014 models and others).

Features of Panasonic IP devices (i-Pro series) configuration

When Panasonic IP-device (i-Pro series) is configured to compress in MPEG4 format, the **Speed** slider controls videodata bitrate on the settings panel of the **Video Capture Device** object. When this parameter is changed, both the speed of video stream and image quality are changed.

Note

WV-NP1000\1004, WV-F284, WV-NP240\244, WV-NS202 models and others are IP-devices (i-Pro series).

Video from Panasonic IP device (i-Pro series) is displayed in the **Monitor** interface window with delay from 15 sec to 1 min, depending on the model of the camera.

Features of TrendNet IP device configuration

TrendNet IP device is restarted when one of the following settings is changed on the settings panel of the **Video Capture Device** object and/or **Camera** object:

1. **Speed** parameter(**Video Capture Device**);
2. **Quality** parameter (**Camera**);
3. **Resolution** parameter (**Camera**).

When the changes are saved, video disappears for about 1 min (time depends on the model of the camera) and then it is restored with new parameters.

Note

TrendNet TV-IP312W, TV-IP212W, TV-IP110 and TV-IP410 IP devices are restarted.

Features of Pelco Spectra IV IP device configuration

If Pelco Spectra IV IP device is configured to compress in MPEG4 format, then the **Resolution** dropdown list on the settings panel of the **Camera** object is used for simultaneous configuration of three video signal parameters:

1. **Resolution**;
2. **Speed**;
3. **Compression quality**.

At the same time, the **Speed** (**Video Capture Device** object) and **Quality** (**Camera** object) parameters do not interfere with the corresponding parameters of a video signal.

To set maximum quality, resolution and speed, select the **Full** or **High** value in the **Resolution** dropdown list on the settings panel of the **Camera** object. The **Standard** value is to be selected to set the lowered compression quality of resolution and speed of video signal.

Features of AEBELL IP device configuration

By default, port 80 is set for connecting to IP devices on the settings panel of the **Video Capture Device** object. Specify the **36688** value in the **Port** field to connect to AEBELL BL-E704F IP server.

Features of Dynacolor IP device configuration

Dynacolor DynaHawk ZH-801+ IP device is restarted when one of the following settings is changed on the settings panel of the **Video Capture Device** object and/or **Camera** object:

1. The **Type** parameter (**Video capture device**) – selection of Dynacolor (mjpeg) or Dynacolor (mpeg-4) video stream compression format;
2. The **Speed** parameter (**Video capture device**);
3. The **Quality** parameter (**Camera**);
4. The **Resolution** parameter (**Camera**);

When the changes are saved, video disappears for about 1 min and then it is restored with new parameters.

There can also be no video for about one minute when Axxon PSIM is started.

Features of Stream Labs IP device configuration

On the page:

- [Features of Wave Cam M5 camera](#)
- [Features of Wave Server Enterprise hardware internetwork](#)
- [Features of Wave Server WH1501 video server](#)

Note

Detailed description of the given devices can be found at <https://www.stream-labs.com/products/>

Features of Wave Cam M5 camera

1. Automatic brightness control. In this mode Axxon PSIM automatically uses internal algorithm of image's brightness control. This mode is enabled when the **Brightness** slider is set to a minimum position. When there are no special requirements to the image, then this mode of brightness control is recommended.

Note

Brightness can be controlled manually, moving the **Brightness** slider.

2. Video stream frame rate. Wave Cam M5 camera supports two channels of video displaying. When only one video channel is engaged in Axxon PSIM, the video stream frame rate is 25 fps. When both channels are engaged, frame rate of video stream for each channel is 12fps.
3. Telemetry. Wave Cam M5 camera is not a PTZ device. One can control some area of an image with the help of video surveillance monitor. While configuring the Telemetry on a Wave Cam M5 camera, do the following:
 - a. Select the protocol of data exchange with a camera - IP-Camera (on the settings panel of the **Telemetry control** object).
 - b. Apply PTZ device to the first video input channel (is set in the **Channel number** list on the settings panel of the **Camera** object).
 - c. Apply telemetry control panel to the first video input channel (is set in the **Channel number** list on the settings panel of the **Camera** object).

Note

The image will move through the second video input channel.

Features of Wave Server Enterprise hardware internetwork

1. Video stream frame rate. When only one camera is connected to Wave Server Enterprise hardware internetwork, the video stream frame rate is 25 fps. When two or more cameras are connected, total frame rate of processed video is 16 fps.

Note

If two video input channels are used, then frame rate of processed video is $16/2=8$ fps. If there are four video input channels, then $16/4=4$ fps

2. Telemetry. Telemetry is performed on an individual card with its own network interface. To configure it, do the following:
 - a. Select the protocol of data exchange with camera with the help of which an analog camera connected to the video server is controlled on the settings panel of the **Telemetry control** object (for example, Pelco-D, Pelco-P, Panasonic-850).
 - b. Create two **Video Capture Device** objects.

Note

For every analog camera connected to Wave Server Enterprise, two **Camera** objects are to be created under different **Video Capture Device** objects for video viewing and telemetry configuration correspondingly.

Features of Wave Server WH1501 video server

Telemetry. When telemetry for Wave Server WH1501 video server is configured, it is necessary to select protocol with the help of which the analog camera connected to the video server is controlled, on the settings panel of the **Telemetry control** object (for example, Pelco-D, Pelco-P, Panasonic-850).

Features of Cisco IP device configuration

Cisco 4500 IP-device supports the following formats of video signal compression:

1. H.264;
2. MJPEG.

While setting the resolution the H.264 format has a higher priority than MJPEG: a possibility to set the resolution for MJPEG exceeding the given for H.264, is not provided.

Priority difference leads to the following effects:

1. After changing the video capture card of the **Cisco(h264)** type for **Cisco(mjpeg)** with standard video resolution, MJPEG video resolution can not be increased;
2. When the video capture card of the **Cisco(mjpeg)** type is changed for **Cisco(h264)** with full video resolution, the resolution will be changed from 704*576 to 1280*720. Resolution 720*576 will be set after return to the **Cisco(mjpeg)** type.

Note

The type of a video capture card is selected in the **Type** dropdown list on the settings panel of the **Video Capture Device** object. Video resolution is set with the use of the same parameter on the settings panel of the **Camera** child object.

Features of Mobotix IP device configuration

Features of audio subsystem configuration

Mobotix IP camera supports the following formats of video compression in Axxon PSIM:

1. MJPEG;
2. MxPEG.

Audio subsystem of Mobotix IP devices may be used when video is encoded in MxPEG. To choose this format, select the **MxPEG** codec in video stream settings on the settings panel of the **Camera** object (see [Configuration of multistream video](#)).

By default, video is received in MJPEG format and audio subsystem functionality of IP device is not performed.

Mobotix IP cameras that support sound are Q24M, D12, M22 and others. Detailed description of the supported models and features of their configuration can be found in [Documentation Drivers Pack](#).

Note.

If MxPEG codec and MxPEG decompressor are in use, then video can be not displayed in *Axxon PSIM*. In this case the value of the MxpegResetCounter registry key should be lowered MxpegResetCounter, specified by default – see [Registry keys reference guide](#).

Features of IO configuration

Due to the peculiarities of the Mobotix M16A / M16B / S16D / S16B camera software, when using the Mobotix MX-232-IO-BOX module, *Axxon PSIM* can track the state of only one of the two sensors. For example, if you first close the first sensor, and then close the second sensor, *Axxon PSIM* will display the state of only the first sensor, and the second one will be ignored.

Up to 5 Mobotix MX-232-IO-BOX modules can be connected to Mobotix M16A / M16B / S16D / S16B IP cameras. When several modules are connected, the numbering of sensors and relays in the *Axxon PSIM* is continuous: sensor/relay number 1 and 2 should be set for the first module, 3 and 4 for the second etc. The sensor numbers must match the relay numbers.

In case of problems with receiving/sending an event from sensor/relay of the Mobotix MX-232-IO-BOX module, it is recommended to restore the default settings in the web interface of the IP camera.

Characteristics of joint operation of Jassun and Bosch cameras

Some errors can appear while the Bosch camera working if the ActiveX add-on is installed for the Jassun camera.

Note.

This add-on is provided to the installation while entering the camera web-interface.

Features of configuring ONVIF or Hikvision IP devices behind NAT

Some devices, for example ONVIF or Hikvision IP devices, connect to *Axxon PSIM* via the HTTP protocol and use HTTP protocol to transmit settings, PTZ control, etc., but at the same time they transmit video, sound and metadata via the RTSP protocol. In this case, by default, the RTSP port from which the device transmits certain data is reported by the IP device itself in response to an HTTP request from *Axxon PSIM*. Please refer to the manufacturer's documentation to find out if RTSP port is required.

However, the RTSP port returned by the device may not be correct if the IP device is behind NAT.

In this case, after creating and configuring the **Video capture device** object (see [Configuring video acquisition from IP devices](#) or [Connecting devices via the ONVIF protocol](#)), specify the RTSP port from which *Axxon PSIM* should request data in the **RTSP** field on the settings panel of the created object:

The screenshot shows the configuration interface for a video capture device. The device is named "Video capture device 1" and is located on "LOCALHOST". The configuration panel shows the following settings:

- Type: ONVIF
- Model: (empty)
- Firmware: (empty)
- PCI channel: 00
- Signal: PAL
- Resolution: Standard
- Rate: (slider between min and max)
- IP address: 85.172.174.48
- Port: 8084
- RTSP: 5554 (highlighted with a red box)
- Name: (empty)
- Password: (masked with dots)
- Activate watchdog: (unchecked)
- Use device settings: (checked)

Buttons for "Apply" and "Undo" are visible at the bottom.

Example.

For example, there is an ONVIF device on the local network having an IP address of 192.168.1.53, an HTTP port of 80, and an RTSP port of 554.

At the same time, the device is brought into the global network through NAT, and *Axxon PSIM* connects to the device using IP address 85.172.174.48, HTTP port 8084 and RTSP port 5554.

3.2.8 Changing the transport protocol used by IP-device

Axxon PSIM™ provides an opportunity to change the transport protocol used by the IP-device. The following types of protocols can be used:

1. TCP-based protocols.

This protocol is reliable; safety and reliability of data delivery is provided when used at the network layer of the operating system. On the other hand, this is its fault: the packet loss will cause re-sending the data. This requires substantial additional resources and time in order to determine the loss and send the data again.

Recommended for use:

- a. In busy networks where serious packet loss are possible (caused by the equipment, communication media, etc.).
- b. When the integrity of the picture is more important than speed of response (for example, when recording to the archive).

Not recommended for use:

- a. In the high-bit-rate stream (high fps and resolution, low compression).
- b. For situations where a delay between the true and the observed picture is more important than the loss of a picture (for example, live video).

Some cameras (for example, ArecontVision) have serious FPS limitations when TCP protocol is in use.

2. UDP-based protocols.

These protocols are "unreliable", i.e. transport layer does not provide data delivery for them. On the other hand, this protocol provides a fast data transmission and low delay. Also, in case of low losses and high fps the picture is smoother.

Moreover, some UDP protocols, particularly RTP, have packet losses processed at the application layer (i.e., means of application, rather than the OS). This allows using algorithms of adjustment stream width and packet loss processing that are fitted for multimedia transmission. So sometimes these protocols better solve the problem of bad data transmission in networks.

Recommended for use:

- a. In networks with low packet loss (in-door, office network).
- b. For situations where a delay between the true and the observed picture is more important than the loss of a picture (for example, live video).
- c. In the high-bit-rate stream (high fps and resolution, low compression).

Not recommended for use:

- a. In busy networks where serious packet loss are possible (because of the equipment, communication media, etc.).
- b. When the integrity of the picture is more important than speed of response (for example, when recording to the archive).

Note.

Axxon PSIM™ does not support IP devices over https protocol.

In order to change the transport protocols for IP device, add the following key to the registry:

1. Path: HKEY_LOCAL_MACHINE \SOFTWARE\AxxonSoft\Axxon PSIM\Video\TransportProtocols (for 64-bit system the path is HKEY_LOCAL_MACHINE\SOFTWARE\Wow6432Node\AxxonSoft\Axxon PSIM\Video\TransportProtocols). If the path does not exist, then create the corresponding section.
2. Key name: <Driver name>. The driver name, not the name of the IP-device vendor, is used as name of the key. Name of the driver is included in the name of the corresponding ipd-file which is located in the installation directory of Drivers Pack (for example, the file C:\Program Files\Common Files\AxxonSoft\Ipint.DriverPack\3.0.0\Ipint.Axis.ipd for Axis devices). In most cases, the driver name

matches the name of the IP-device vendor. To clarify the driver name for the desired vendor contact AxxonSoft technical support.

Note.

If IP-device is connected via RTSP, use the name of the key "RTSP" without quotes, the value is case-sensitive.

- Value: <protocol>. For example, "http" (TCP-based) or "tftp" (UDP-based) for ArecontVision, "tcp" or "udp" for Axis. The key value is case-sensitive.

Note.

For some Axis devices, it is possible to enable multicast in the device. The IP-device will be the source of broadcasting. Set the "multicast" value to the Axis parameter to enable broadcasting. On the moment of document writing this feature is supported by the following models of Axis cameras: 243SA, 243Q, 241Q, 232D+, 225FD, 221, 216FD and 211A.

- Key type: string value.

3.2.9 Digest authentication when accessing IP device

Axxon PSIM supports safe digest authentication (Digest HTTP authentication) when accessing IP device. To perform this type of authentication, it is to be supported by the IP device.

Note.

Information whether the IP device supports digest authentication can be found at the vendor's website.

For Axxon PSIM to use the IP device via digest authentication only, one is to add ":" as the last character when adding the IP device manually (by creating the **Camera** object) or using the IP Wizard.

For instance, if the camera access password is *root* and the camera supports digest authentication, then root:password is to be specified.

3.2.10 Configuring getting video from web cameras via HTTP protocol

In Axxon PSIM video can be received via HTTP protocol from specific cameras that enable viewing video in the web browser at the HTTP address. MJPEG and MPEG2 codecs are supported.

Note

VLC Media Player can be used in Axxon PSIM in order to check if video from these cameras can be received. If this player gets the video, then it will be available in Axxon PSIM.

Add a device streaming video via HTTP protocol as follows:

1. Create the **Video capture device** based on the **Computer** object in the **Hardware** tab of the **System settings** dialog box (1).

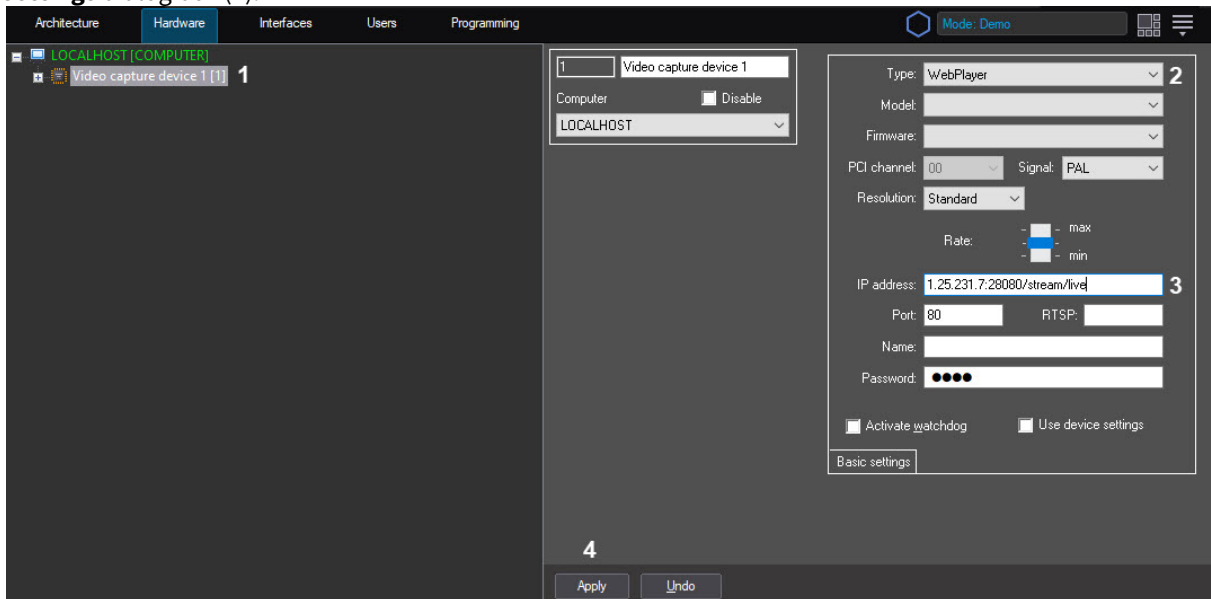

2. Select **WebPlayer** in the **Type** dropdown list (2).
3. In the **IP address** field, specify the address to get video from the web camera (3). Any format of IP address is possible. Do not use URL at which viewing video in the browser is available as the address, use the address of the video that is streamed on a page. Sometimes it can be found in the source code of the page.
Examples of addresses:
http://81.25.231.7:28080/stream/live
http://root:1@10.0.40.248:80/mjpg/1/video.mjpg – the address to get video from Axis camera that supports video streaming in the corresponding format.
4. Click the **Apply** button (4).
5. Create the Camera object based on the created **Video capture device** object.

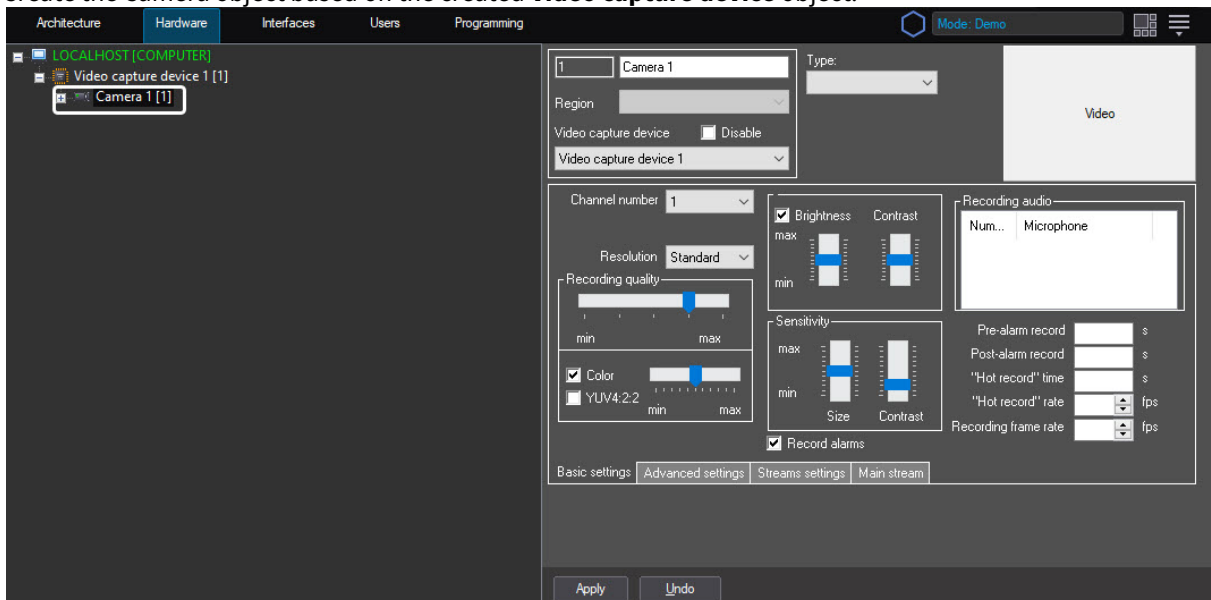

6. Click the **Apply** button.

The device streaming video via HTTP protocol is now added.

3.3 Configuring Sensor-Relay devices in Axxon PSIM™ software

3.3.1 Creating and configuring the Relay system object

The **Relay** system object is created under the **Video Capture Device** object.

The **Relay** object is created and main parameters are set in the following order:

1. Go to the **Hardware** tab in the settings panel of *Axxon PSIM™* (1).
2. Create the **Relay** system object under the **Video Capture Device** object or select the corresponding object in the object tree in the **Hardware** tab on the settings panel of *Axxon PSIM™* (2).

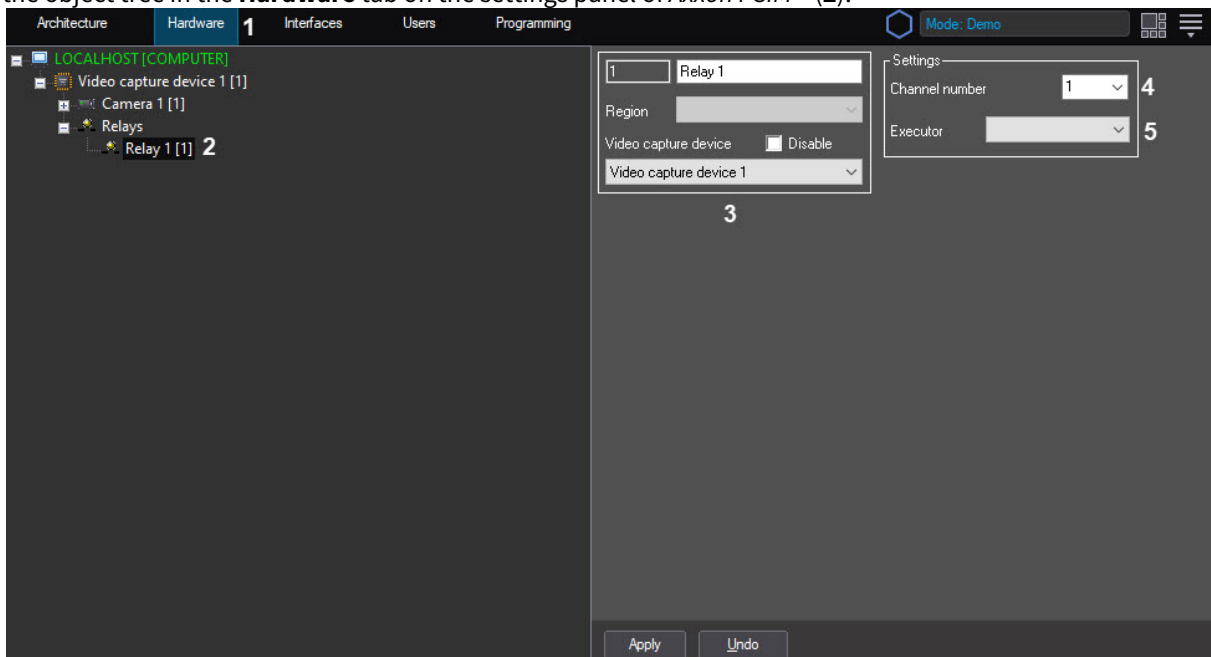

3. Specify the ID and name of the **Relay** object and select the **Video Capture Device** object to become the parent of the **Relay** object (3).

Note

If the Sensor-Relay card is used, then specify that video capture card with ADC to which the Sensor-Relay card is connected.

4. Select the **Channel number** matching the number of output connector to which the relay is connected (4).
5. In the **Executor** dropdown list, select the type of executive device used as the relay in the guarded area (5). The **Executor** parameter is used for selecting the icon on the interactive map. This parameter is essential for better perception of information (displayed on the map as object icons) by Operator and for real-time intercepting by Operator if required.

The types of executive devices available for the **Relay** system object are given in the table.

Executive device	Description
Light	Icon of the interactive map for the device responding to changes in the illumination in the guarded area

Signal	Icon of the interactive map for the device responding to sound changes in the guarded area
Lock	Icon of the interactive map for the device responding to locking/unlocking a window, door, etc.

6. Click the **Apply** button to save the changes.

Creating and configuring the **Relay** system object is completed.

3.3.2 Creating and configuring the Sensor system object

The **Sensor** system object is created under the **Video Capture Device** object.

The **Sensor** object is created and main parameters are set in the following order:

1. Go to the **Hardware** tab in the settings panel of *Axxon PSIM™* (1).
2. Create the **Sensor** system object under the **Video Capture Device** object or select the corresponding object in the object tree in the **Hardware** tab on the settings panel of *Axxon PSIM™* (2).

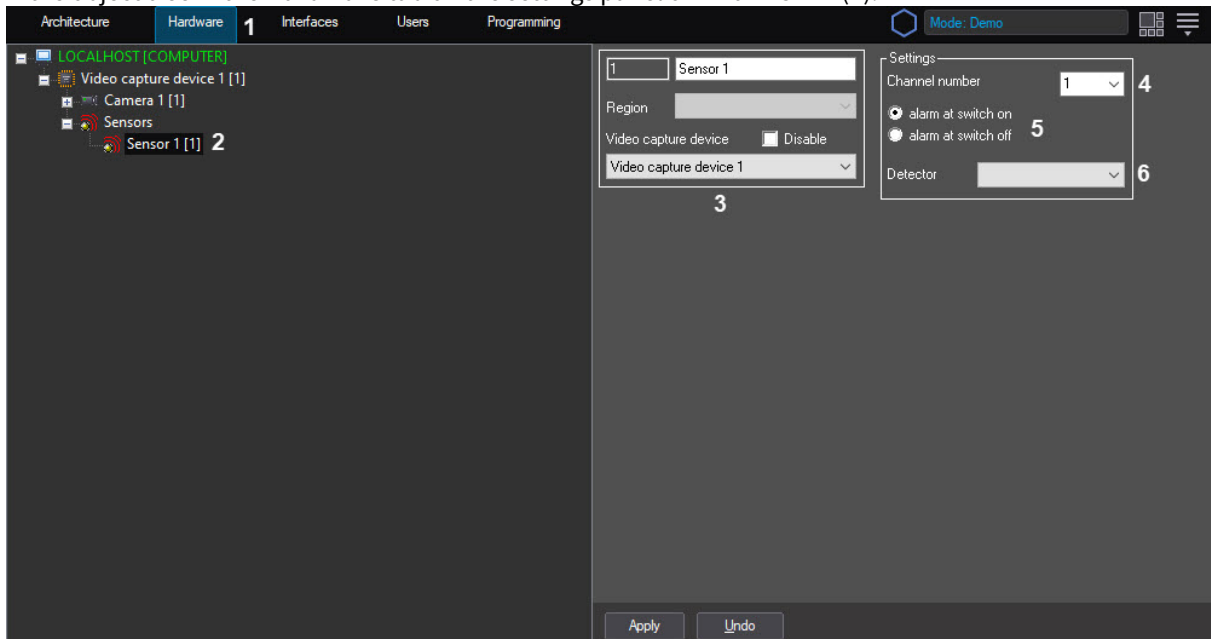

3. Specify the ID and name of the **Sensor** object and select the **Video Capture Device** object to become the parent of the **Sensor** object (3).

Note

If the Sensor-Relay card is used, then specify that video capture card with ADC to which the Sensor-Relay card is connected.

4. Select the channel number matching the number of output connector to which the sensor is connected (4).
5. In the group of switches, select the alarm mode: at switch on or at switch off. By default, the **alarm at switch on** mode is selected (5).
The executive device corresponding to the **Sensor** system object operates in one of modes: **alarm at switch on** or **alarm at switch off**.

Note
Sensors connected to Panasonic IP-devices (i-Pro series) trigger only at switch off.

When the **alarm at switch off** mode is selected, the normal state of the sensor is open. When the sensor closes, it triggers and the corresponding actions are performed in Axxon PSIM™.

- In the **Hardware** dropdown list, select the type of executive device used as the detector in the guarded area (6).

The **Hardware** parameter is used for selecting the icon on the interactive map. This parameter is essential for better perception of information (displayed on the map as object icons) by Operator and for real-time intercepting by Operator if required.

Types of detectors available for the **Sensor** system object are given in the table.

Hardware	Description
Infrared	Icon of the interactive map for the motion detectors
PIR	Icon of the interactive map for the device on the ceiling of the guarded area
Glass	Icon of the interactive map for the device on the window of the guarded area responding when the window is broken
Fire	Icon of the interactive map for the device responding to changes of heat conditions in the guarded area
Window	Icon of the interactive map for the device installed some distance away the window and responding when the window is broken
Smoke	Icon of the interactive map for the device responding to smoke in the guarded area
Reed switch	Icon of the interactive map for the device responding to locking/unlocking a window, door, etc.

- Click the **Apply** button to save the changes.

When the Sensor is created in the objects tree, it is in the "Armed" state. To change the Sensor state, use a macro (see the [Creating and using macros](#) section) or control the Sensor on the Map (see the [Configuring the interactive map for object state indication and controlling the objects](#) and [Operations with sensors](#) sections). If the Sensor is armed, then at the Sensor switching on / off the "Alarm" event appears depending on the alarm mode setting - see step 5 above. If the Sensor is disarmed, the "Closed" / "Opened" events appear correspondingly.

Note.
Axxon PSIM requests sensor state 3 times per second. Short-term triggering that last for less than 1/3 of a second can be skipped.

Creating and configuring the **Sensor** system object is completed.

3.3.3 Creating and configuring connection with the Analog sensor (input)

An analog sensor is represented in Axxon PSIM as **Analog sensor** object created under the **Video Capture Device** object. On the settings panel of the **Video Capture Device** object, set the Type, Model and Firmware of the IP-device or Sensor/Relay card to which the analog sensor is connected and set the connection parameters. Use the [Camera discovery tool](#) to create the corresponding objects without any additional configuration if the analog input is connected to a device integrated via Drivers Pack (see [Drivers Pack Documentation](#)).

The analog sensor is configured as follows:

1. Go to the **Analog sensor** object settings panel.

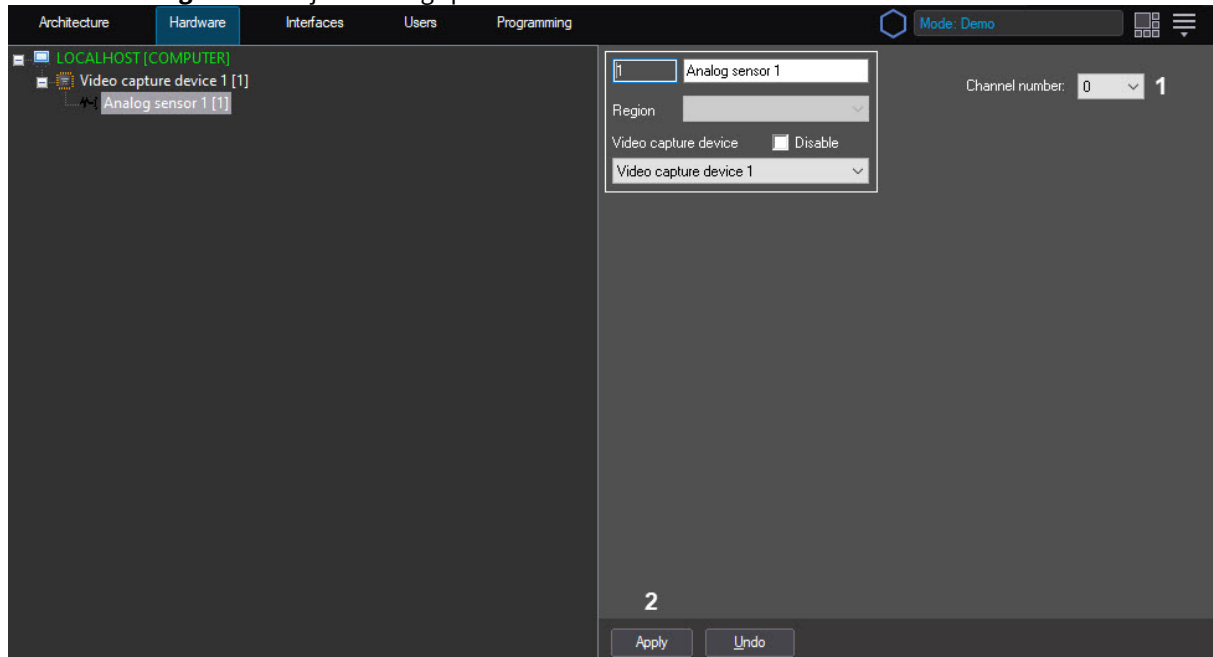

2. In the **Channel number** drop-down list, select the channel number matching the number of output connector to which the sensor is connected (1).
3. Click **Apply** (2).

The analog sensor configuration is completed.

3.3.4 Configuring Sensor-Relay expansion cards

How to configure relay connection

If relays are connected to the Sensor-Relay card, then up to 4 **Relay** objects can be created under the **Video Capture Device** parent object.

All the **Relay** objects corresponding to relays connected to one Sensor-Relay card are to be created in the **Hardware** object tree under the **Video Capture Device** object corresponding to the video capture card where the Sensor-Relay card is installed.

At least one **Camera** object is to be created under the same **Video Capture device** object for relay to work.

If the Sensor-Relay card is installed on FS-5, FS-6 or FS-16 video capture card, then the **Relay** objects are to be created under any **Video Capture Device** object within the hardware card.

If the Sensor-Relay card is installed on SC3B0N16 (WS216) video capture card, then the **Relay** objects are to be created under the **Video Capture Device** object with **04** value of the PCI-channel.

If the Sensor-Relay card is installed on FS-8 video capture card, then the **Relay** objects are to be created under the **Video Capture Device** object with **07** value of the PCI-channel.

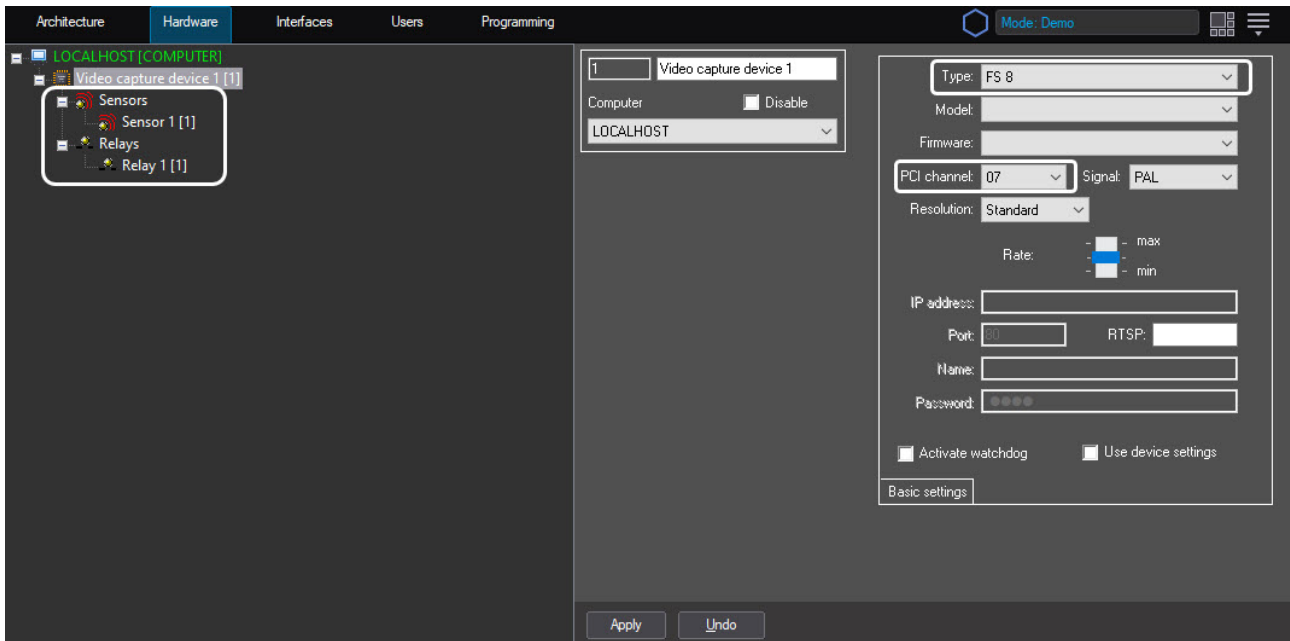

Relay objects can be relocated in the object tree. To change the parent **Video Capture Device** object of the **Relay** objects, change the value of the **Video Capture Device** object on the settings panel of the **Relay** object. The value of this parameter is to correspond to the number of the **Video Capture Device** object (in the object tree) under which the **Relay** object is to be located. If the value of the **Video Capture Device** parameter is changed on the settings panel of the **Relay** object, then the object is moved to the branch of child objects of the corresponding **Video Capture Device** object.

Note

All **Relay** objects related to one Sensor-Relay card are to be located in child branches under the same **Video Capture Device** object for proper operation of *Axxon PSIM™*. The **Relay** objects are not to be located under different **Video Capture Device** objects even if these objects represent the same video capture card with the adjustable Sensor-Relay card.

The next figure shows an example of locating the **Relay** objects in the object tree when two FS-6 (or FS-16) video capture cards with 4 relays connected to the first 4/4 (or 16/4) Sensor-Relay card and 2 relays connected to the second one are used.

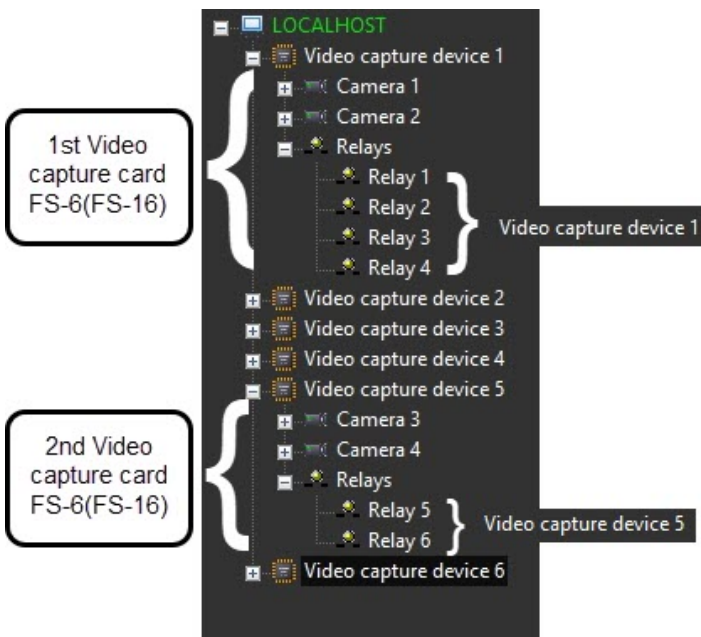

Configuring the **Relay** objects one is to specify the channel numbers of sensor connection to the Sensor-Relay card according to the numbers of the DO pins on the card.

To change the channel numeration, use the **Channel Number** list on the settings panel of the **Relay** object.

The 4/4 and 16/4 Sensor-Relay cards allow connecting up to 4 relay channels according to the license key file.

The figure below shows an example of the channel numeration configuration of 4 relays connected to one 4/4 Sensor-Relay card installed on FS-6 (or FS-16) video capture card (4 ADCs for 4 **Video Capture Device** objects).

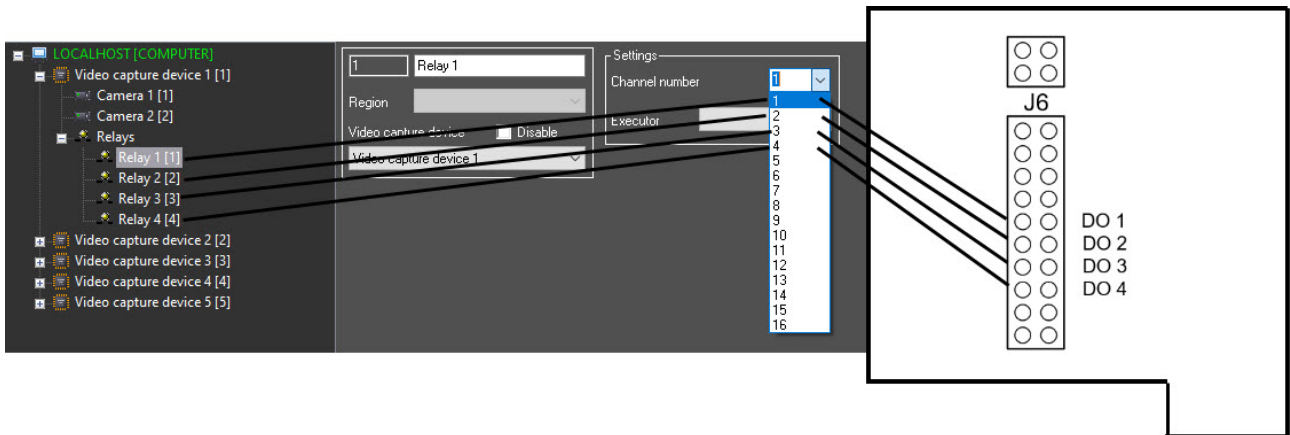

Channels of the second 16/4 Sensor-Relay card are numbered 1-4 according to input connectors.

Example of the channel numeration configuration of relays connected on the second (next) 16/4 Sensor-Relay card installed on FS-6 (or FS-16) video capture card (4 ADCs for 4 **Video Capture Device** objects):

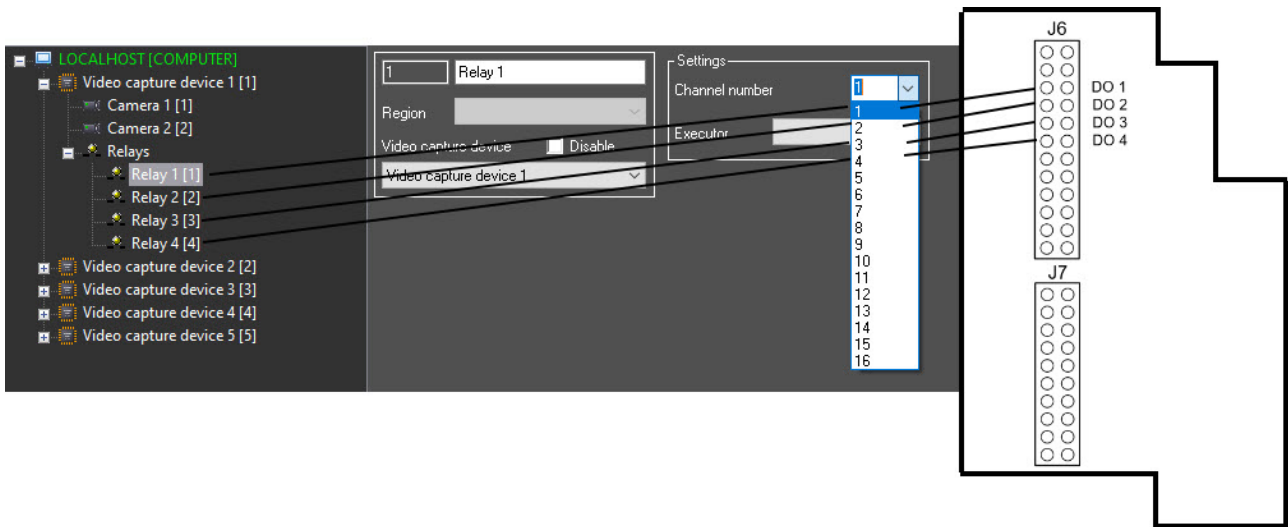

How to configure sensor connection using 4/4 Sensor-Relay card

One can create up to 4 **Sensor** objects under the **Video Capture Device** object when 4/4 Sensor-Relay card is installed.

All the **Sensor** objects corresponding to sensors connected to one 4/4 Sensor-Relay card are to be created in the **Hardware** object tree under the **Video Capture Device** object corresponding to the video capture card where the Sensor-Relay card is installed.

At least one **Camera** object is to be created under the same **Video Capture device** object for sensor to work.

If the Sensor-Relay card is installed on FS-5, FS-6 or FS-16 video capture card, then the **Sensor** objects are to be created under any **Video Capture Device** object within the hardware card.

If the Sensor-Relay card is installed on SC3B0N16 (WS216) video capture card, then the **Sensor** objects are to be created under the **Video Capture Device** object with **00** value of the PCI-channel.

If the Sensor-Relay card is installed on FS-8 video capture card, then the **Sensor** objects are to be created under the **Video Capture Device** object with **07** value of the PCI-channel.

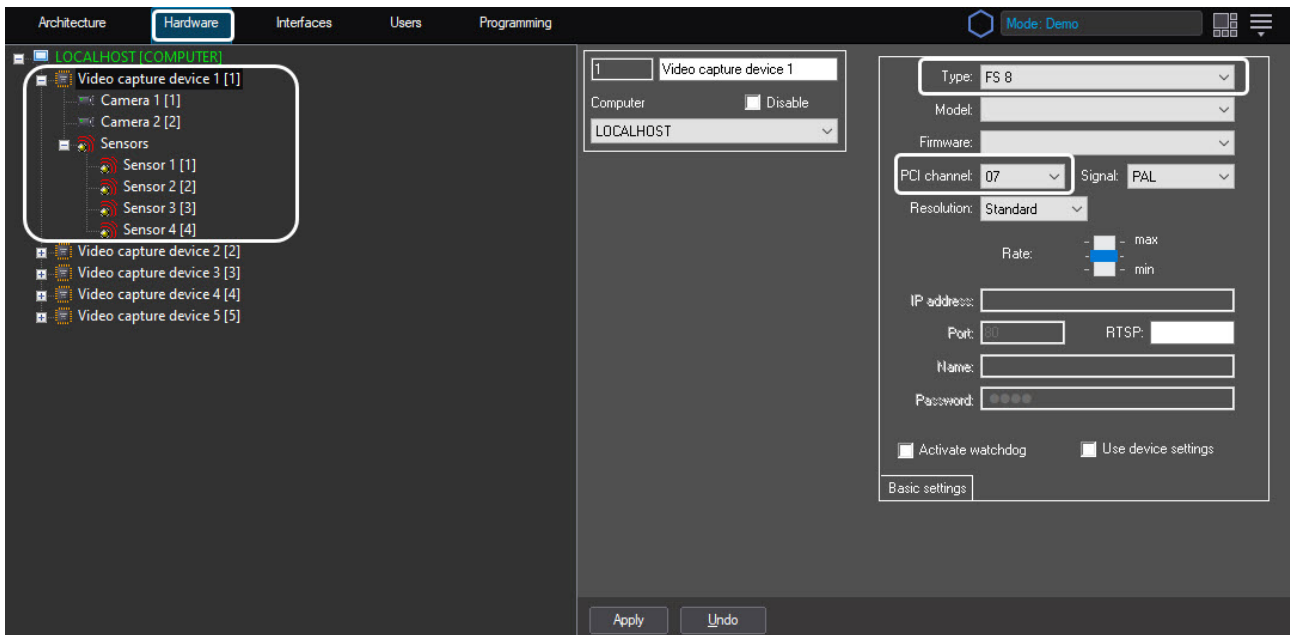

Sensor objects can be relocated in the object tree. To change the parent **Video Capture Device** object of the **Sensor** objects, change the value of the Video Capture Device object on the settings panel of the **Sensor** object. The value of this parameter is to correspond to the number of the **Video Capture Device** object (in the object tree) under which the **Sensor** object is to be located. If the value of the **Video Capture Device** parameter is changed on the settings panel of the **Sensor** object, then the object is relocated to the branch of child objects of the corresponding **Video Capture Device** object.

Note

All **Sensor** objects related to one Sensor-Relay card are to be located in child branches under the same **Video Capture Device** object for proper operation of *Axxon PSIM™*. The **Sensor** objects are not to be located under different **Video Capture Device** objects even if these objects represent the same video capture card with the adjustable Sensor-Relay card.

The next figure shows an example of locating the **Sensor** objects in the object tree when two FS-6 (or FS-16) video capture cards with 4 sensors connected to the first 4/4 Sensor-Relay card and 2 sensors connected to the second one are used.

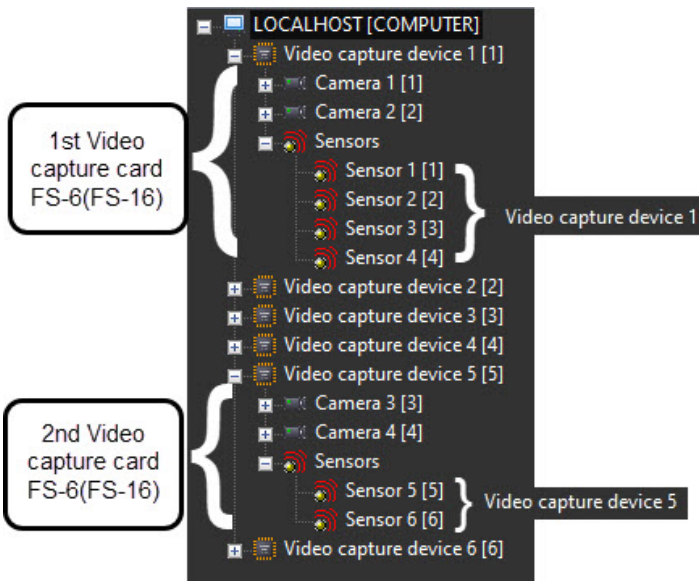

When configuring the **Sensor** objects one is to specify the channel numbers of sensor connection to the Sensor-Relay card according to the numbers of the input connectors.

To change the channel numeration, use the **Channel Number** list on the settings panel of the **Sensor** object.

The 4/4 and 16/4 Sensor-Relay cards allow connecting up to 4 sensor channels according to the license key file.

The next figure shows an example of the channel numeration configuration of 4 sensors connected to one 4/4 Sensor-Relay card installed on FS-6 (or FS-16) video capture card (4 ADCs for 4 **Video Capture Device** objects):

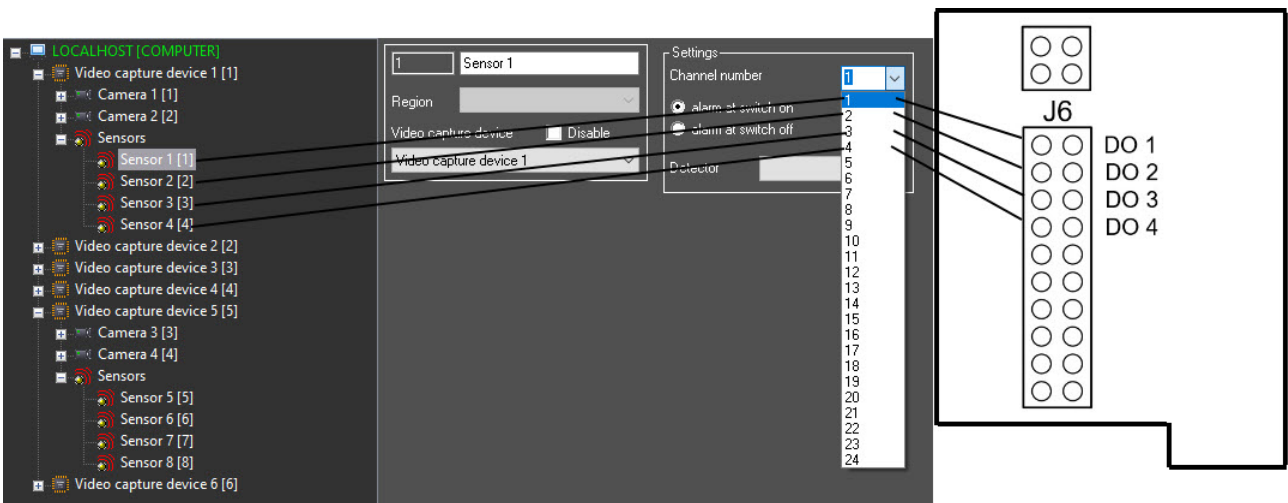

Channels of the second 4/4 Sensor-Relay card are numbered 1-4 according to input connectors.

Example of the channel numeration configuration of sensors connected on the second (next) 4/4 Sensor-Relay card installed on FS-6 (or FS-16) video capture card (4 ADCs for 4 **Video Capture Device** objects):

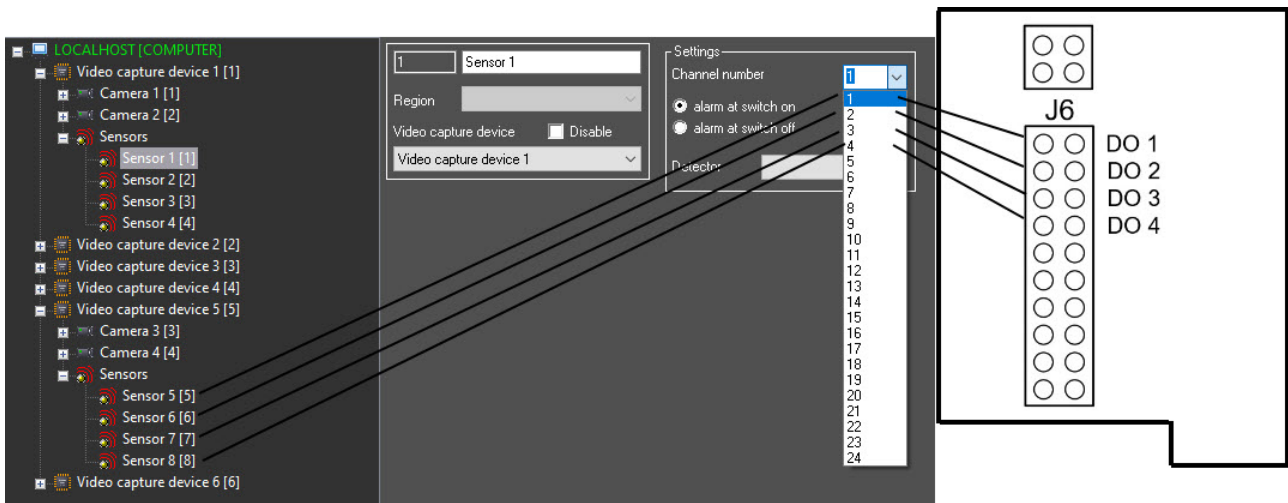

How to configure sensor connection using 16/4 Sensor-Relay card

One can create up to 16 **Sensor** objects under the **Video Capture Device** object when 16/4 Sensor-Relay card is installed.

All the **Sensor** objects corresponding to sensors connected to one 16/4 Sensor-Relay are to be created in the **Hardware** object tree under the **Video Capture Device** object corresponding to the video capture card where the Sensor-Relay card is installed.

At least one **Camera** object is to be created under the same **Video Capture device** object for sensor to work.

If the Sensor-Relay card is installed on FS-5, FS-6 or FS-16 video capture card, then the **Sensor** objects are to be created under any **Video Capture Device** object within the hardware card.

If the Sensor-Relay card is installed on FS-8 video capture card, then the **Sensor** objects are to be created under the **Video Capture Device** object with **07** value of the PCI-channel.

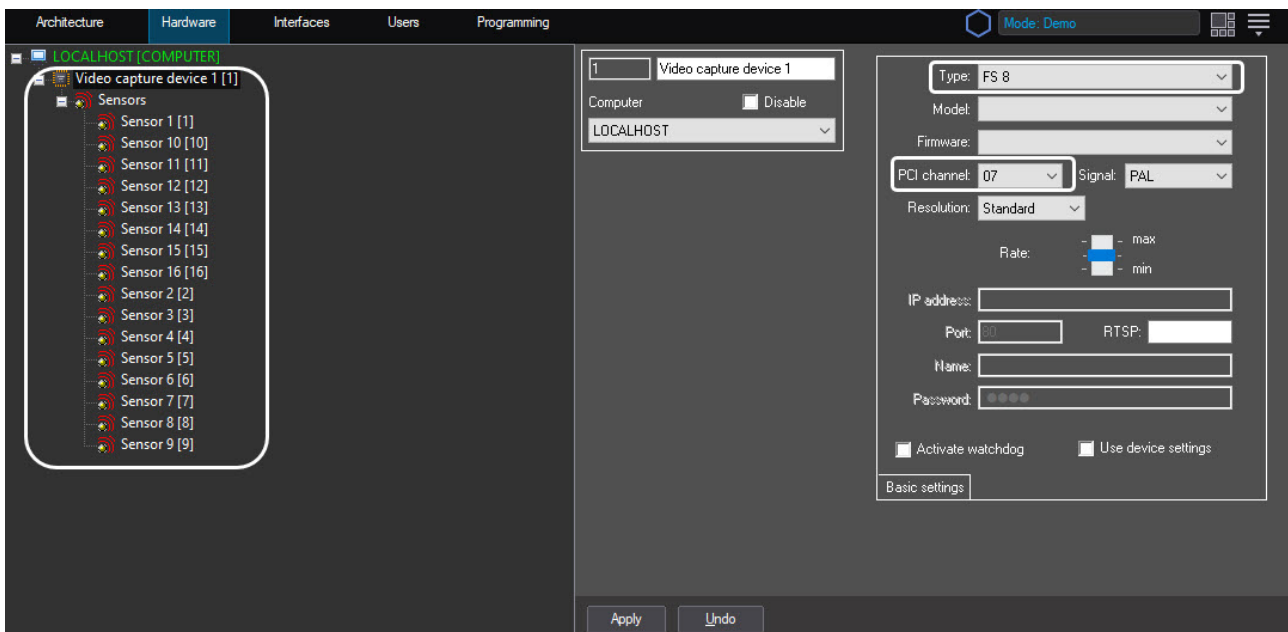

Sensor objects can be relocated in the object tree. To change the parent **Video Capture Device** object of the **Sensor** objects, change the value of the **Video Capture Device** object on the settings panel of the **Sensor** object. The value of this parameter is to correspond to the number of the **Video Capture Device** object (in the object tree) under which the **Sensor** object is to be located. If the value of the **Video Capture Device** parameter is changed on the settings panel of the **Sensor** object, then the object is relocated to the branch of child objects of the corresponding **Video Capture Device** object.

The figure below shows an example of locating the **Sensor** objects in the object tree when two FS-6 (FS-16) video capture cards with 16 sensors connected to the first 16/4 Sensor-Relay card and 2 sensors connected to the second one are used.

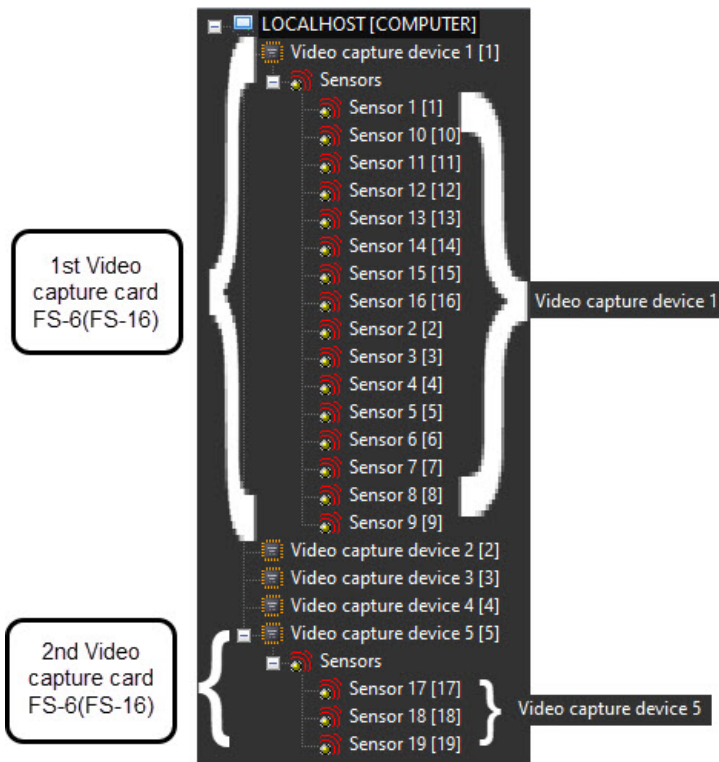

When configuring the **Sensor** objects one is to specify the channel numbers of sensor connection to the Sensor-Relay card according to the numbers of the input connectors.

To change the channel numeration, use the **Channel Number** list on the settings panel of the **Sensor** object.

The 16/4 Sensor-Relay cards allow connecting up to 4 sensor channels according to the license key file.

The figure below shows an example of the channel numeration configuration on the 16/4 Sensor-Relay card installed on FS-6 (or FS-16) video capture card (4 ADCs for 4 **Video Capture Device** objects):

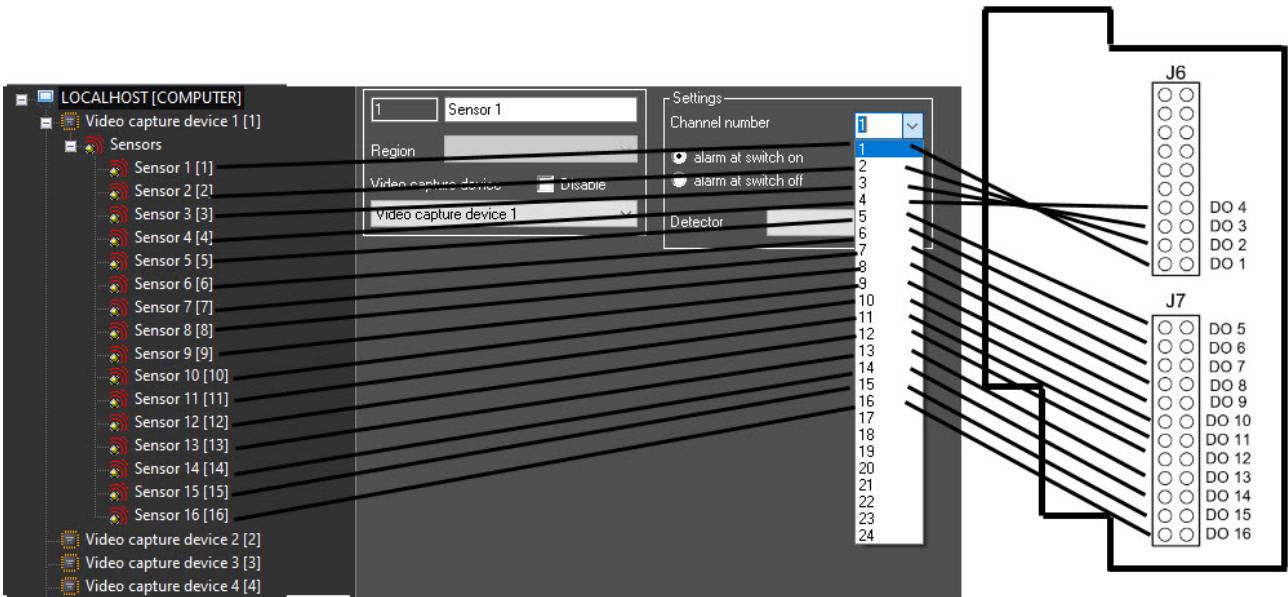

Channels of the second 16/4 Sensor-Relay card are numbered 1-16 according to input connectors.

Example of the channel numeration configuration of sensors connected on the second (next) 16/4 Sensor-Relay card installed on FS-6 (or FS-16) video capture card (4 ADCs for 4 **Video Capture Device** objects):

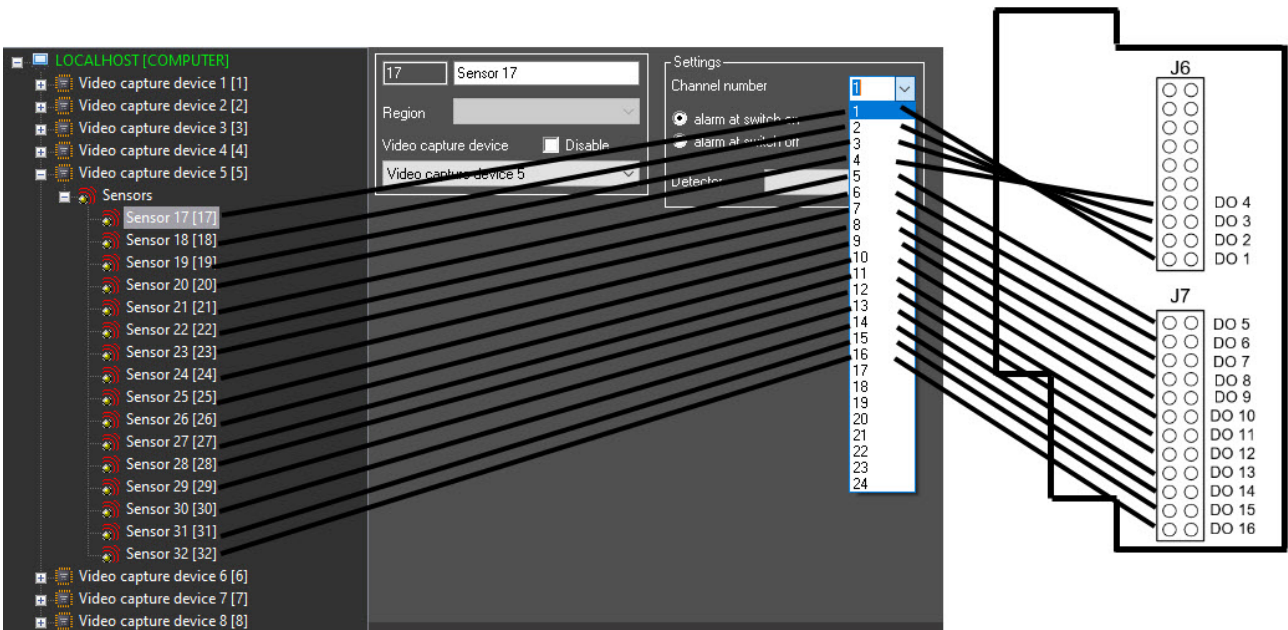

3.3.5 Configuring Sensor-Relay expansion cards (low profile)

Connecting relays of 4/4 Sensor-Relay expansion cards (low profile)

Depending on what video capture card is in use, the **Relay** objects corresponding to relays connected to 4/4 Sensor-Relay card (low profile) are created under the **Video Capture Device** objects of one of the following types: **SC200Q4 Low profile (FS 115)**, **SC300Q16 (FX 4)**, **SC300D16 (FX 8)**, **SC310N16 (FX 16)**, **SC3B0N16 (WS 216)**, **SC230N4** and **SC590N4**.

At least one **Camera** object is to be created under the same **Video Capture device** object for relay to work.

The **Relay** objects are to be created under the **Video Capture Device** object that has the first PCI channel. E.g., when building security video subsystem with the use of two SC300Q16 (FX4) and two Sensor-Relay cards (low profile) the **Relay** objects are to be created under the **Video Capture Device** objects with **00** (for the first SC300Q16 (FX4) card) and **04** (for the second SC300Q16 (FX4) card) values of PCI channels.

If the 4/4 Sensor-Relay card (low profile) is installed on SC3B0N16 (WS216) video capture card, then the **Relay** objects are to be created under the **Video Capture Device** object with **04** value of the PCI-channel.

For SC310N16 (FX16) video capture card the **Relay** objects can be created under the **Video Capture Device** object with 00 or 08 value of PCI channel. Working channel is discovered experimentally.

For SC230N4 video capture card the **Relay** objects are to be created under the **Video Capture Device** object with 03 value of PCI channel.

For SC590N4 card **Relay** objects can be created under the **Video Capture Device** object with number of PCI-channel equal to **01** (see [Connecting 4/4 Sensor-Relay \(low profile\) cards](#) section for Sensor-Relay cards connected to low contacts of J2 connector of CS590N4 card) and to **03** (for Sensor-Relay card connected to top contacts of J2 connector of SC590N4 card). If the SC590N4 card is in use do not create not more than 4 **Relay** objects for one **Video Capture Device** object.

Note

Number of PCI channels (number of the **Video Capture Device** objects) for all types of cards is given in [Features of video subsystem configuration](#) section.

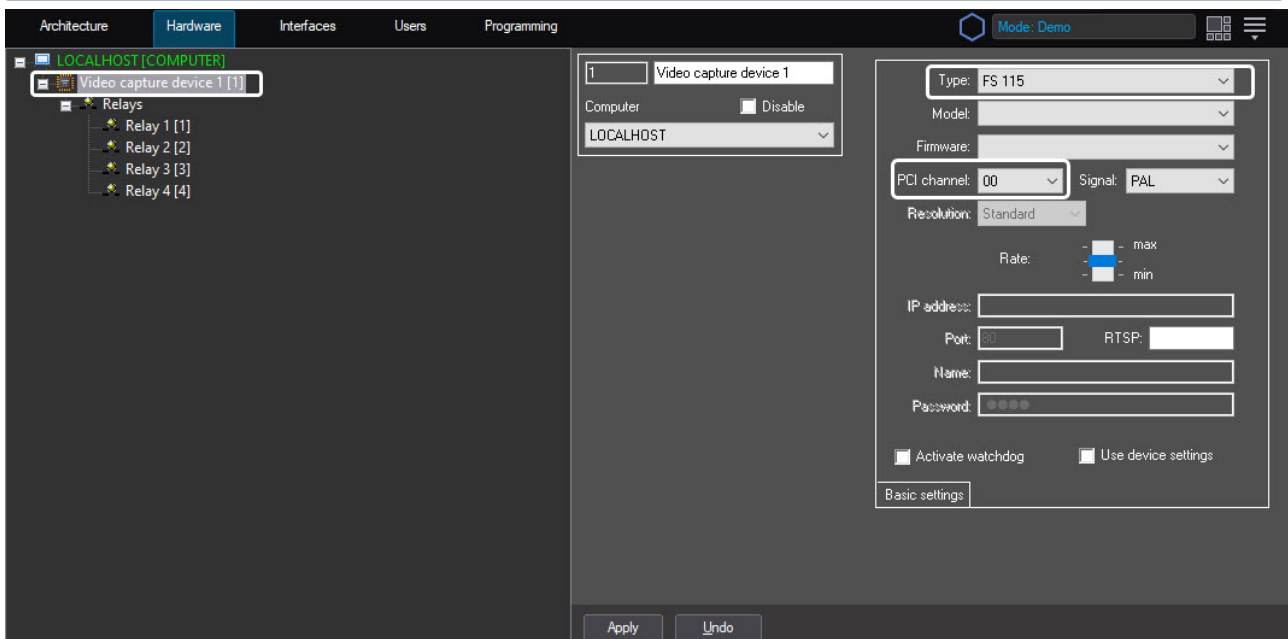

One can create up to 4 **Relay** objects under the **Video Capture Device** object. When configuring the **Relay** objects one is to specify the channel numbers of relay connection to 4/4 Sensor-Relay card (low profile) according to external pinout of the card.

To change the channel numeration, use the **Channel Number** list on the settings panel of the **Relay** object.

4/4 Sensor-Relay card (low profile) allows connecting up to 4 relay channels according to the license key file.

The figure below shows an example of the channel numeration configuration of 4 relays connected to one 4/4 Sensor-Relay card (low profile).



Channels of the second 4/4 Sensor-Relay card (low profile) are numbered 1-4.

Connecting sensors of 4/4 Sensor-Relay expansion cards (low profile)

Depending on what video capture card is in use, the **Sensor** objects corresponding to sensors connected to 4/4 Sensor-Relay card (low profile) are created under the **Video Capture Device** objects of one of the following types: **SC200Q4 Low profile (FS 115)**, **SC300Q16 (FX 4)**, **SC300D16 (FX 8)**, **SC310N16 (FX 16)**, **SC3B0N16 (WS 216)**, **SC230N4** and **SC590N4**.

At least one **Camera** object is to be created under the same **Video Capture device** object for sensor to work.

The **Sensor** objects are to be created under the **Video Capture Device** object that has the first PCI channel. E.g., building security video subsystem with the use of two SC300Q16 (FX4) and two Sensor-Relay cards (low profile) the **Sensor** objects are to be created under the **Video Capture Device** objects with 00 (for the first SC300Q16 (FX4) card) and 04 (for the second SC300Q16 (FX4) card) values of PCI channels.

If the Sensor-Relay card (low profile) is installed on SC3B0N16 (WS216) video capture card, then the **Sensor** objects are to be created under the **Video Capture Device** object with 00 value of the PCI-channel.

For SC310N16 (FX16) video capture card the **Sensor** objects can be created under the **Video Capture Device** object with 00 or 08 value of PCI channel. Working channel is discovered experimentally.

For SC230N4 video capture card the **Sensor** objects are to be created under the **Video Capture Device** object with 03 value of the PCI channel.

For the SC590N4 card the **Sensor** objects can be created under the **Video Capture Device** with number of PCI-channel that equals 00 (see [Connecting 4/4 Sensor-Relay \(low profile\) cards](#) section for Sensor-Relay card connected to low contacts of J2 connector of CS590N4 card) and 02 (for DI/DO card connected to top contacts of J2 connector of SC590N4 card). If the SC590N4 card is in use, do not create more than 4 **Sensors** objects for one **Video Capture Device**.

Note

Number of PCI channels (number of the **Video Capture Device** objects) for all types of cards is given in [Features of video subsystem configuration](#) section.

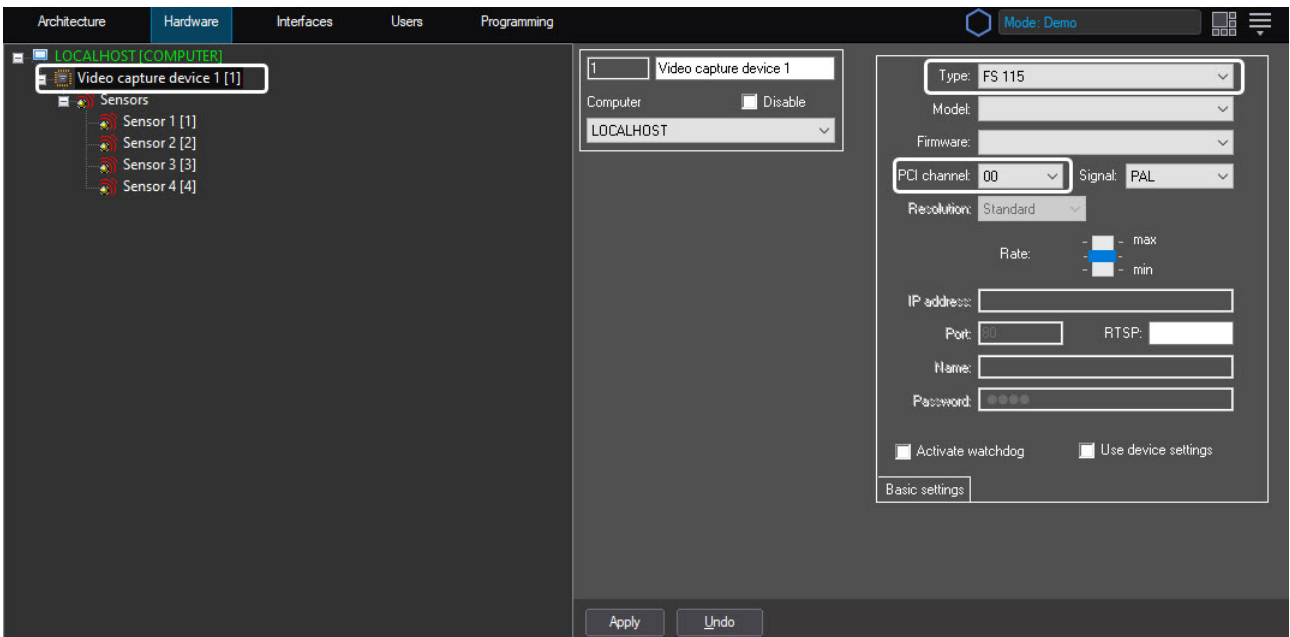

One can create up to 4 **Sensor** objects under the **Video Capture Device** object. When configuring the **Sensor** objects one is to specify the channel numbers of sensor connection to 4/4 Sensor-Relay card (low profile). 4/4 Sensor-Relay card (low profile) allows connecting up to 4 sensor channels according to the license key file.

To change the channel numeration, use the **Channel Number** list on the settings panel of the **Sensor** object.

Channels are numbered according to external pinout of the card. The figure below shows an example of the channel numeration configuration of 4 sensors connected to one 4/4 Sensor-Relay card (low profile).

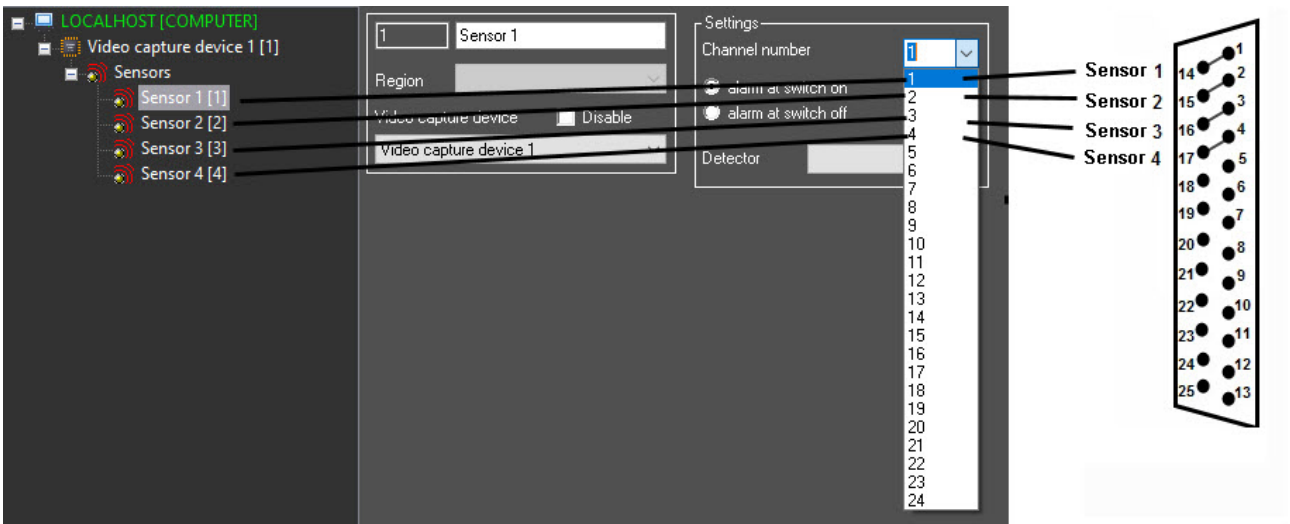

Channels of the second 4/4 Sensor-Relay card (low profile) are numbered 1-4.

3.3.6 Configuring SL USBIO cards

On the page:

- [Features of running the SL USBIO 16x8 card drivers](#)
- [Connecting relays](#)
- [Connecting sensors](#)

Features of running the SL USBIO 16x8 card drivers

Running of SL USBIO 16x8 card drivers in Windows can take up to 10 minutes. To reduce this time to 2 minutes, use the utility to configure the USB device sensor/relay SL USBIO 16x8 - it can be downloaded at [AxxonSoft website](#). Set a lower value of the **TimeOut PowerUp** parameter for each device in this utility (recommended value is 10-20 seconds). The utility does not provide the ability to select a specific device, so you should connect one SL USBIO 16x8 device in turn, disconnecting others.

Axxon PSIM is to be started after running drivers of SL USBIO 16x8 devices (you can control the status of the drivers via the Windows Device Manager).

If auto start of *Axxon PSIM* is configured using the Auto Startup feature in Windows, then configure the delayed start of *Axxon PSIM* at least 2 minutes after the operating system reboots.

If *Axxon PSIM* starts as a Windows wrapper, safe operation of the SLIO USBIO 16x8 card is not guaranteed in *Axxon PSIM*. In this case, select another way to start *Axxon PSIM* (see [Configuring system startup and shutdown](#) section in [Administrator's Guide](#)).

Connecting relays

The **Relay** objects corresponding to relays connected to SL USBIO (4x4, 16x8 and 24x4) card are created under the **Video Capture Device** objects of the **SL USBio** type.

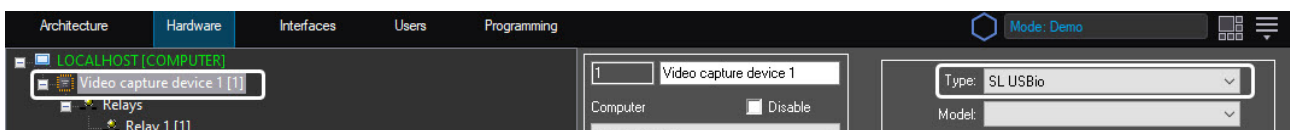

When configuring the **Relay** objects one is to specify the channel numbers of relay connection to the card. Channels are numbered according to external pinout of the card (see [Appendix 5. Electrical and technical specifications of Sensor-Relay cards](#)).

To change the channel numeration, use the **Channel Number** list on the settings panel of the **Relay** object.

Connecting sensors

The **Sensor** objects corresponding to sensors connected to SL USBIO (4x4, 16x8 and 24x4) card are created under the **Video Capture Device** objects of the **SL USBio** type.

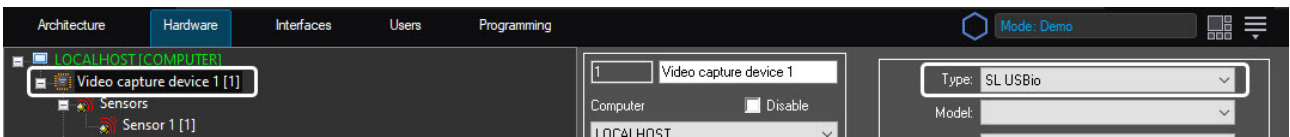

When configuring the **Sensor** objects one is to specify the channel numbers of sensor connection to the card. Channels are numbered according to external pinout of the card (see [Appendix 5. Electrical and technical specifications of Sensor-Relay cards](#)).

To change the channel numeration, use the **Channel Number** list on the settings panel of the **Sensor** object.

3.3.7 Configuring MO USBIO 4x4 devices

Connecting relays MO USBIO 4x4

The **Relay** objects corresponding to relays connected to MO USBIO 4x4 device are created under the **Video Capture Device** objects of the **MO USBio** type. One can create up to 4 **Relay** objects under the **Video Capture Device** object.

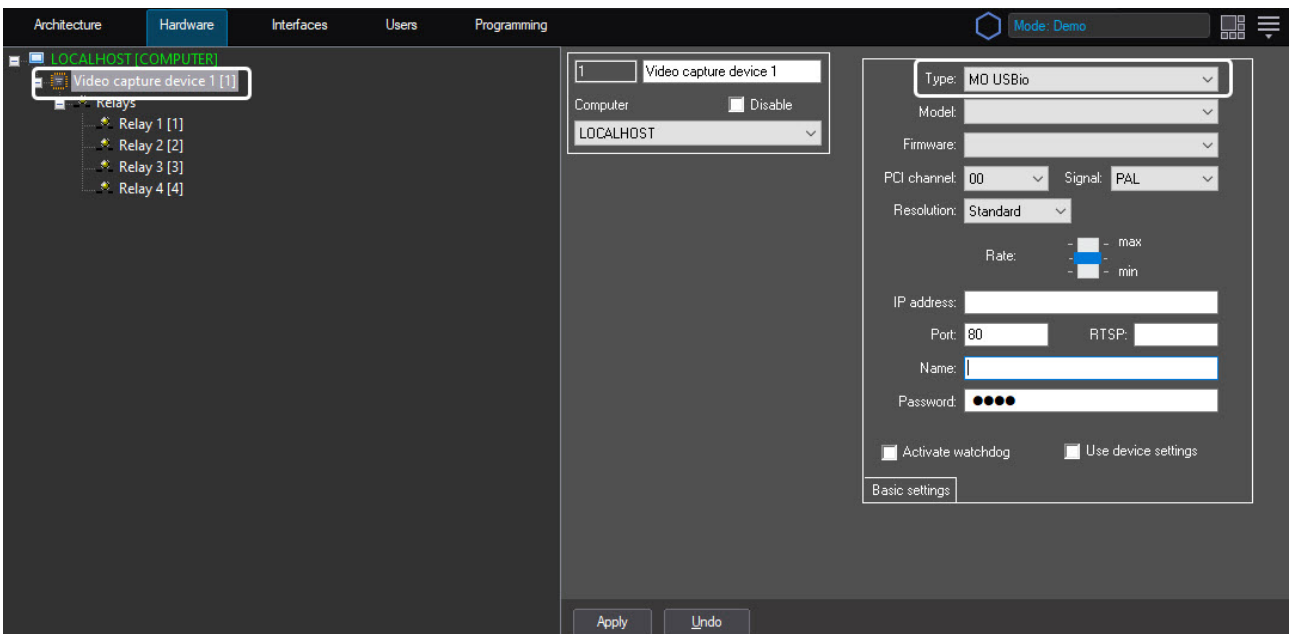

Note

One is to specify the number of PCI channel that is not used by another object.

When configuring the **Relay** objects one is to specify the channel numbers of relay connection to MO USBIO 4x4 device. Channels are numbered according to external pinout of the device (see [Connecting MO USBIO 4x4 external module](#) or [Connecting MO USBIO 4x4 cards](#) sections).

To change the channel numeration, use the **Channel Number** list on the settings panel of the **Relay** object.

MO USBIO 4x4 device allows connecting up to 4 relay channels according to the license key file.

The figure below shows an example of the channel numeration configuration of 4 relays connected to one MO USBIO 4x4 device.

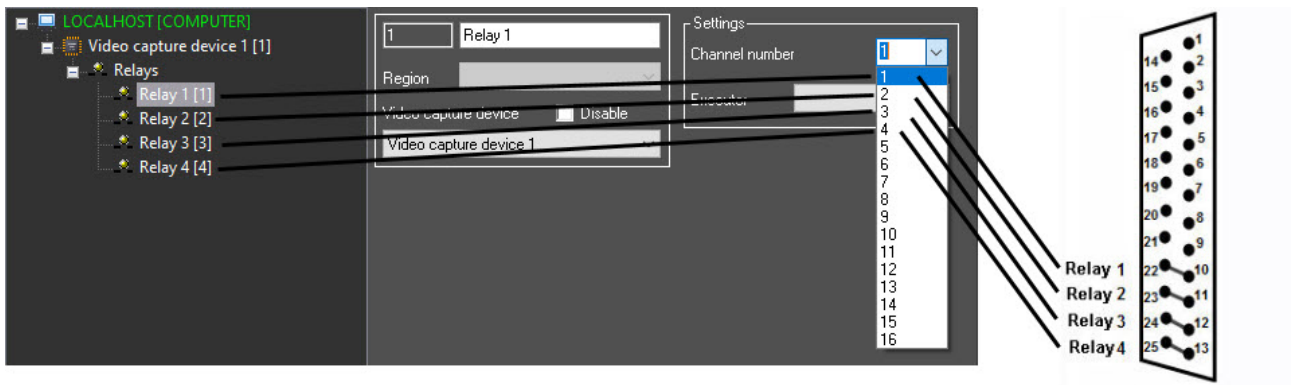

The channels of the second (next) device are numbered 1-4.

Connecting sensors MO USBIO 4x4

The **Sensor** objects corresponding to sensors connected to MO USBIO 4x4 device are created under the **Video Capture Device** objects of the **MO USBio** type. One can create up to 4 **Sensor** objects under the **Video Capture Device** object.

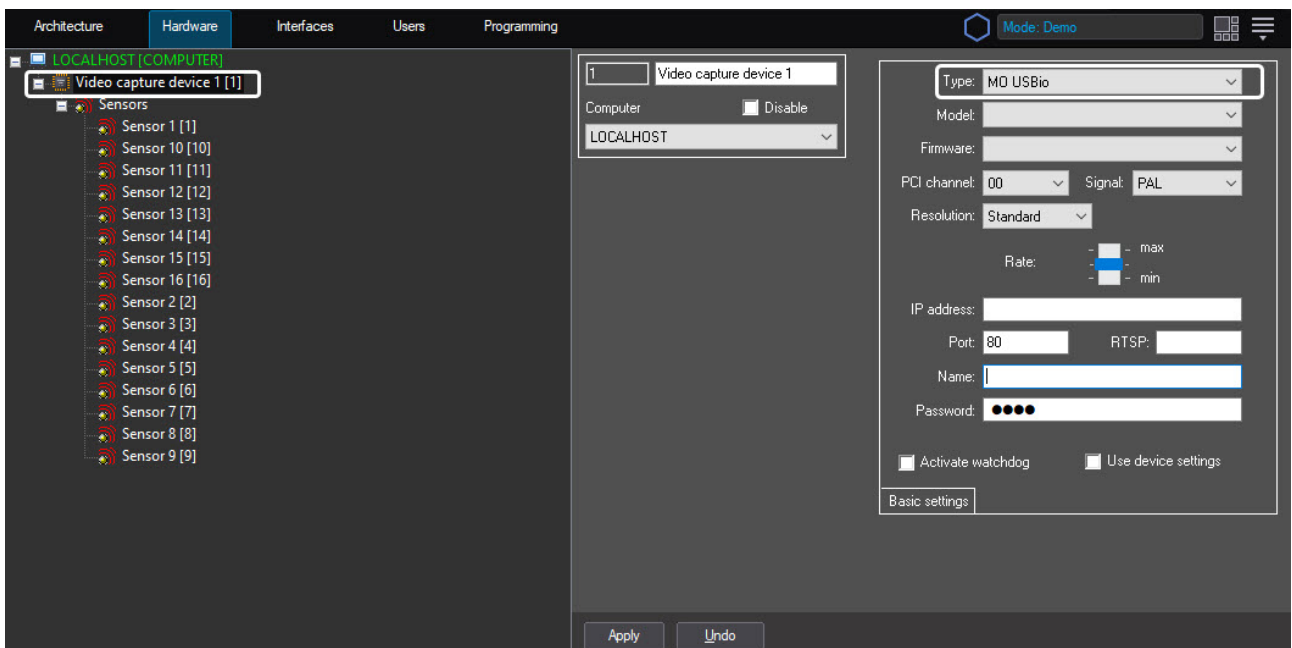

Note

One is to specify the number of PCI channel that is not used by another object.

When configuring the **Sensor** objects one is to specify the channel numbers of sensor connection to MO USBIO 4x4 device. Channels are numbered according to external pinout of the device (see [Connecting MO USBIO 4x4 external module](#) or [Connecting MO USBIO 4x4 cards](#) sections).

To change the channel numeration, use the **Channel Number** list on the settings panel of the **Sensor** object.

MO USBIO 4x4 device allows connecting up to 4 sensor channels according to the license key file.

The figure below shows an example of the channel numeration configuration of 4 sensors connected to one MO USBIO 4x4 device.

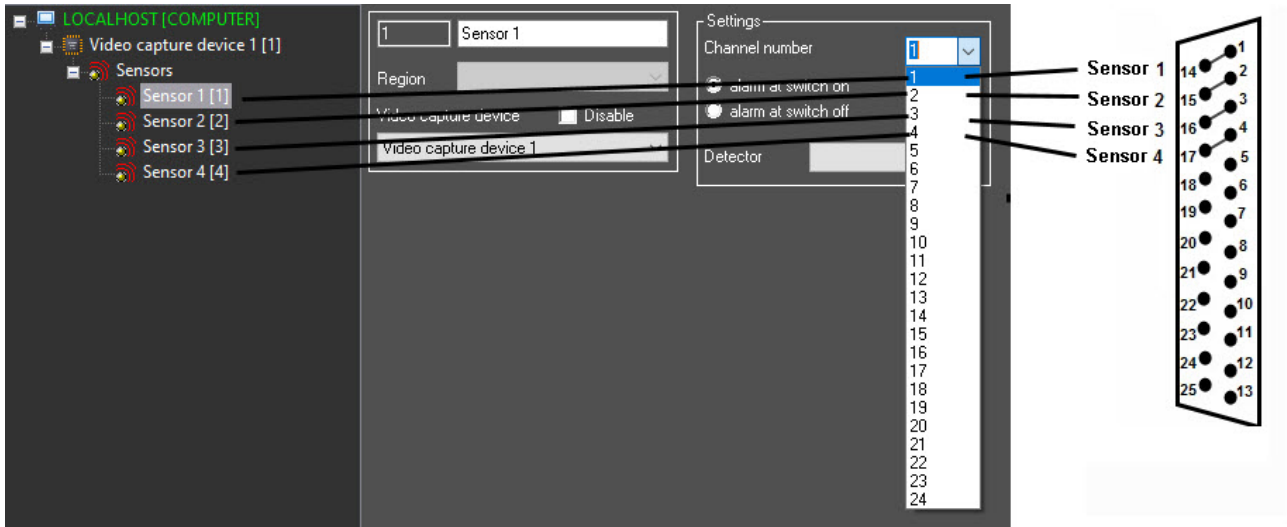

The channels of the second (next) device are numbered 1-4.

3.3.8 Configuring sensors and relays connected via IP devices

If relays are connected to the Server via IP devices, then select the corresponding type of IP device on the settings panel of the **Video Capture Device** object; set IP address, name and password in order to connect to camera (see [Configuring IP devices](#) section).

Note

If relays are connected to the Server via Bosh IP device, then specify the **service** value in the **Name** field. With another value the functionality of the relay is not performed on the Server.

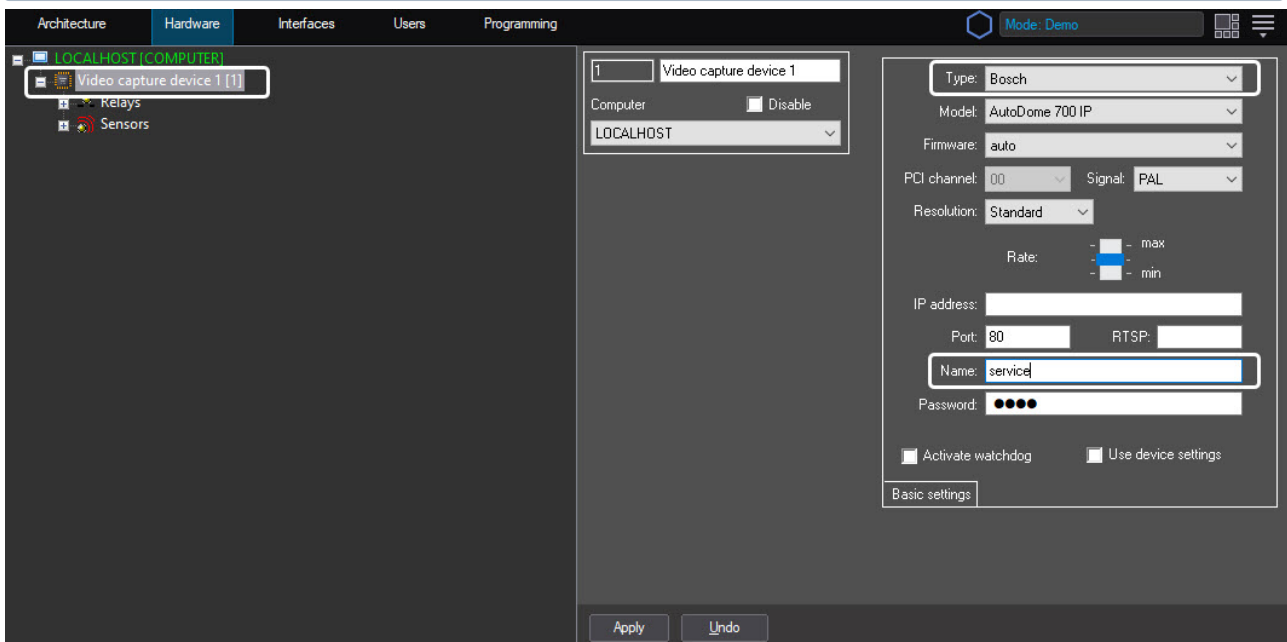

If Smartec STS-IPT-880 IP server is in use, then sensors are to be connected to those channels for which the **Camera** objects are created. Channel with N number corresponds to 2 sensor channels with 2N-1 and 2N numbers.

Note

Smartec STS-IPT-880 IP Server supports up to 8 video channels and 16 sensors (2 sensors for each channel).

To connect each pair of sensors create the **Camera** object with **N** channel number, then create two **Sensor** objects with 2N-1 and 2N channel numbers. The **Camera** and **Sensor** objects are created under one **Video Capture Device** object of the **Smartec** type. If sensors are connected via inactive video channel (no **Camera** object), then the functionality of sensors is not performed on the Server.

To implement the functionality of sensors connected via AEBELL BL-E704F IP server disable the **Auto Work Plan** mode. This mode is enabled/disabled via Web interface of IP server or in the dialog box of the **Network DVR Monitor System** utility (see the reference documentation on IP server).

3.3.9 Configuring AGRG-IO-16/8-WD-DS Sensor-Relay cards

Sensor-Relay cards are integrated via Drivers Pack, so they can be added to the *Axxon PSIM* hardware tree using the [Camera discovery tool](#).

The *AGRG-IO-16/8-WD-DS* Sensor-Relay cards are configured as follows:

1. Launch the *Camera discovery tool*. To do this, click the **Camera discovery tool** button on the **Settings** panel of the **Computer** object or select the corresponding item in the **Computer** object function menu in the hardware tree.

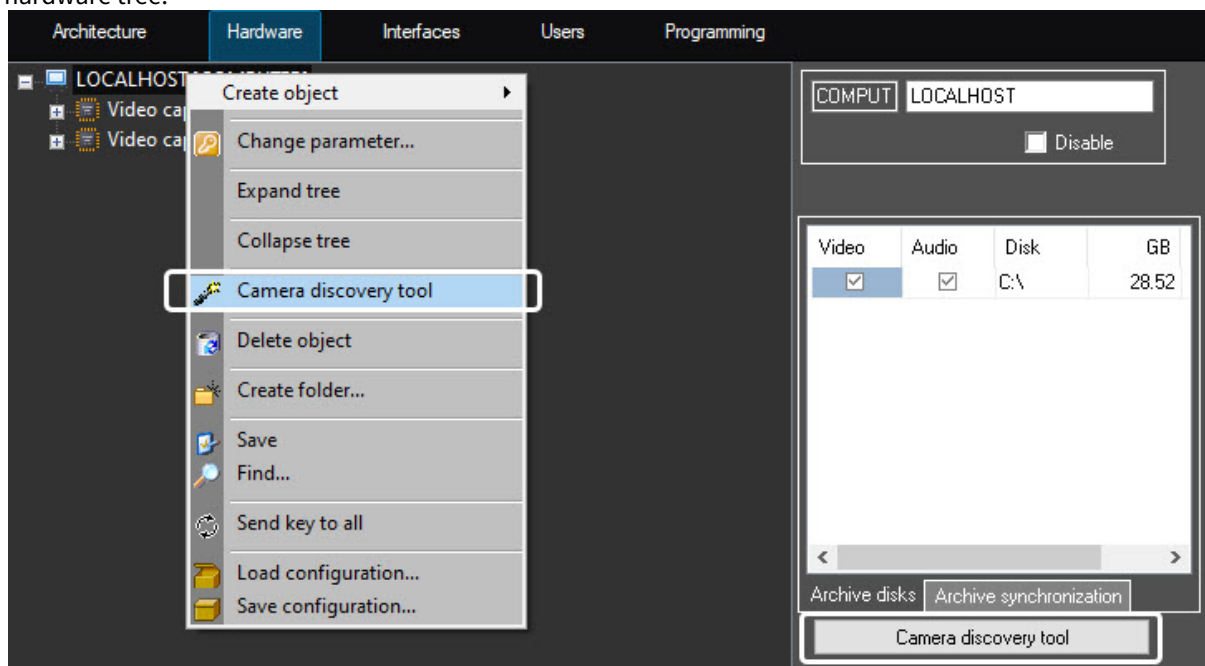

- In the **Ip Wizard** window, set the **AGRG** card checkbox (1).

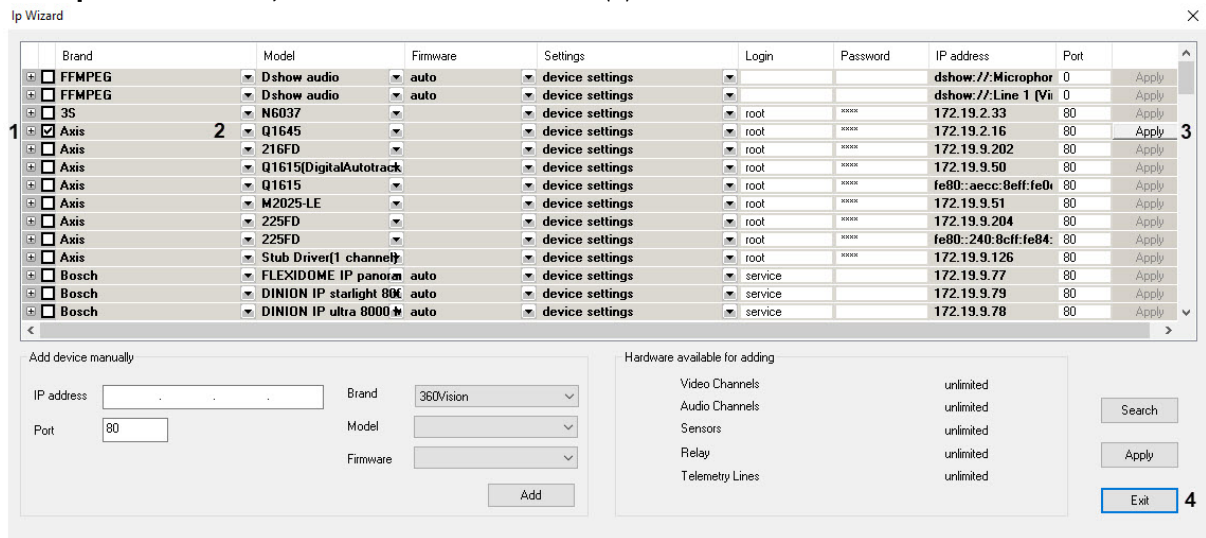

- Make sure that the correct model of the connected device is selected in the **Model** drop-down list (2).

Note

Leave the default values of the settings in all fields.

- By default, all sensors and relays available on the device are enabled in the *Camera discovery tool*. If it is necessary to disable any of them, click on the + button and uncheck the checkboxes next to the corresponding relays (the **Executive device** object) and sensors (the **Contact** object).

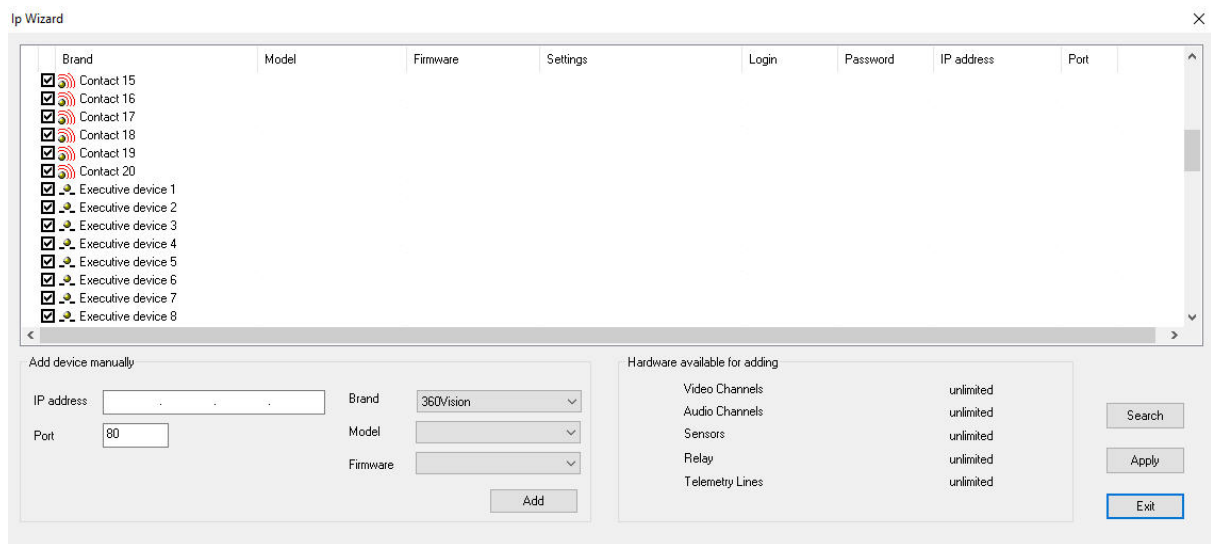
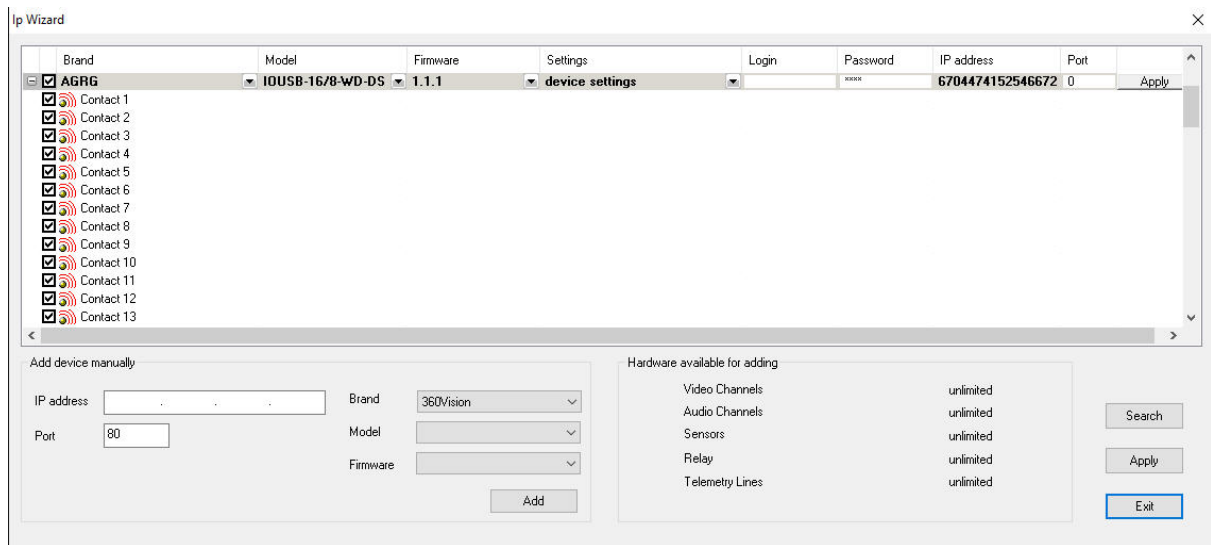

5. Click **Apply** (3).
6. Click **Exit** (4).
7. As a result, the required **Video capture device**, **Sensor** and **Relay** objects will be created in the *Axxon PSIM* hardware tree. The corresponding type, model and firmware of the *AGRG-IO-16/8-WD-DS* card will be displayed on the settings panel of the Video capture device object.

Note

The **IP address** field displays the device serial number. If it is necessary to enter this number manually, then to obtain this number, you will need a utility which is available by the [link](#).

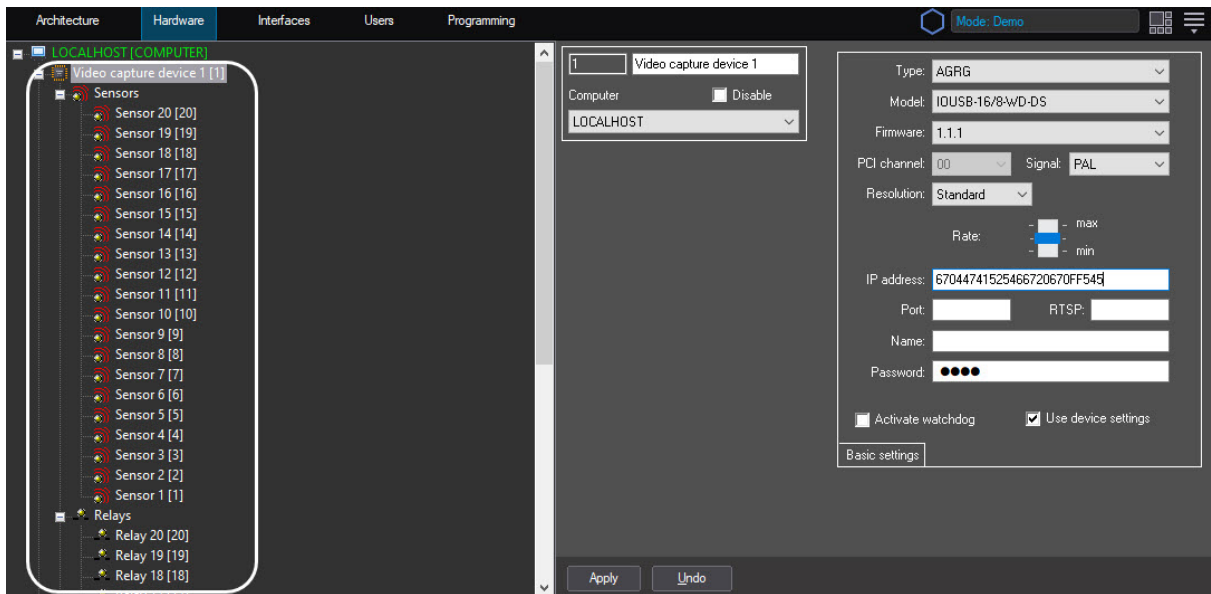

8. If it is necessary to configure the **Relay** objects - see [Creating and configuring the Relay system object](#).
9. If it is necessary to configure the **Sensor** objects - see [Creating and configuring the Sensor system object](#).

Configuring the *AGRG-IO-16/8-WD-DS* Sensor-Relay cards in *Axxon PSIM* is completed.

3.4 PTZ configuration

3.4.1 Use of PTZ devices in the digital video surveillance system

PTZ devices in the digital video surveillance system are used to widen the video surveillance zone by mechanical rotating of the video camera.

The following interface elements of the *Axxon PSIM™* software control the PTZ devices:

1. Surveillance monitor;
2. Telemetry control;
3. Telemetry control panel.

PTZ device is controlled with the help of the following:

1. Mouse and standard keyboard (when using **Surveillance monitor** and **Telemetry control panel** interface objects).
2. Custom devices used for telemetry control, like telemetry remote control and joystick.

To manage simultaneous use of PTZ devices by different users, priorities of PTZ devices control must be set up for the following interface objects:

1. Surveillance monitor;
2. Telemetry control;
3. Telemetry control panel.

3.4.2 Priorities of PTZ control

The **PTZ control** or **Priority** parameter (depending on the type of the object) gives the privileges to control PTZ devices when several interface objects are used or several users control the same PTZ device simultaneously.

To configure interface objects used for PTZ control the value of PTZ control priority is to be selected in the list.

The **PTZ control** parameter is set for the following objects:

1. Surveillance monitor;
2. Telemetry control;
3. Telemetry control panel.

Note

The priority of PTZ control with joystick equals the priority of PTZ control with **Surveillance monitor** and mouse.

Priority parameter of PTZ control can be:

1. Control is forbidden (Forbidden). This item forbids PTZ control.
2. Low (Low priority). PTZ control is the last in the queue after the “normal” and “high” priorities. It is the lowest in the queue in PTZ control.
3. Normal (Normal priority). PTZ is controlled after the device with “high” priority. It is higher in the queue in PTZ control than any device with “low” priority.
4. High (High priority). This item is set as first in the queue in PTZ control. It is the highest in the PTZ control queue.

Contextual menu of selecting the PTZ control priority for the **Monitor** interface object is called **PTZ control** and consists of **Forbidden**, **Low priority**, **Normal priority** and **High priority** items:

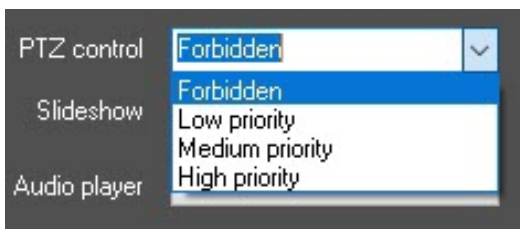

The panel for selecting the PTZ control priority for the **Telemetry control panel** interface object and **Telemetry remote control** system object is called **Priority** and consists of **Forbidden**, **Low priority**, **Normal priority** and **High priority** items:

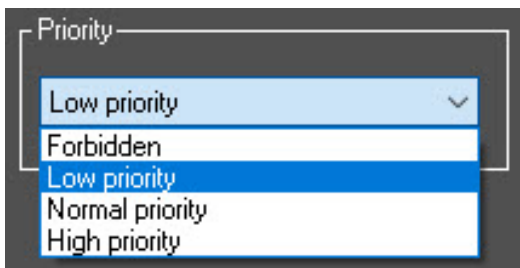

If the same PTZ device is controlled from several workstations with the interface objects of the same type with the same PTZ control priority, then the following rules apply:

1. Any user can control a PTZ device when it is not controlled by another user with the interface of the same control priority.
2. If a user who controls interface object with a higher priority delegates control to a user who controls interface object with a lower priority, then this procedure is delayed. The priority delay time is set with the help of the tweaki.exe utility (Axxon PSIM Advanced Setup).

To change the priority delay time using the tweaki.exe utility, do the following:

1. Run the tweaki.exe utility in the **Tools** folder of the Axxon PSIM™ software installation directory.

2. Select the **PTZ** section (1).

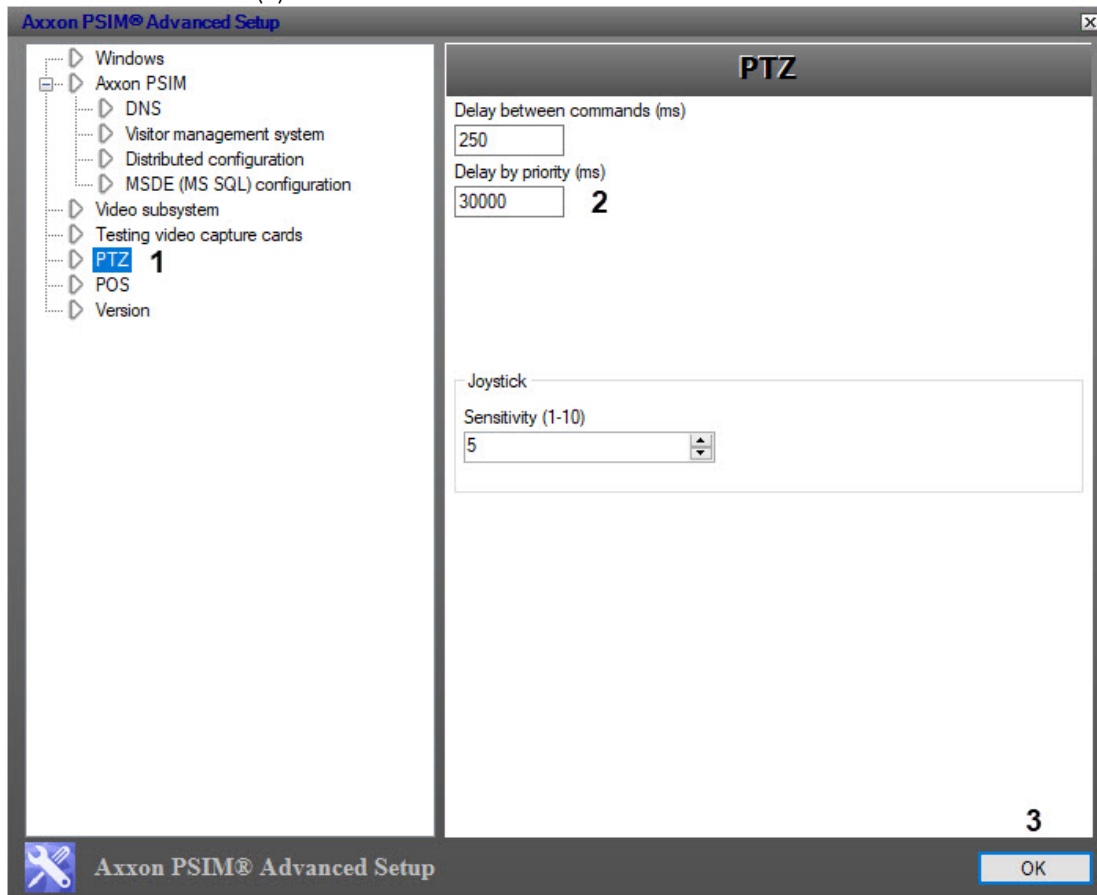

3. Specify the value of PTZ control priority delay in the **Delay by priority (ms)** field (2). The delay parameter is given in milliseconds. The default value is 30000.
4. Click the **OK** button to save the changes (3).

Note

When the objects are configured with variable PTZ priority controls, it is recommended to assign different PTZ control priorities to different system objects (object types). If different system objects have the same PTZ control priority, problems may occur in operation, especially in controlling the PTZ devices.

3.4.3 Configuring PTZ devices (telemetry)

PTZ device setting procedure

PTZ device configuration in the *Axxon PSIM™* software consists of creation and configuration of system objects corresponding to the PTZ module, and user interface for PTZ device operation.

The user interface for PTZ device operation is represented by the following interface objects:

1. **Telemetry control panel;**
2. **Operator query panel;**
3. **Video Monitor.**

Here is PTZ device setting procedure:

1. Configure Server ports to connect PTZ devices (see [Configuring Server ports and remote workstation to connect PTZ devices](#)).
2. Configure PTZ devices (see [Configuring PTZ devices in Axxon PSIM™](#)).
3. Configure **Control panel** (see [Configuring Control panel](#)).
4. Configure **Telemetry control panel** (see [Telemetry control panel configuration](#)).
5. Configure **Operator query panel** for telemetry control (PTZ devices of certain type) (see [Creating and configuring the Operator query panel for telemetry control](#)).
6. Configure **Video Monitor** to control PTZ device with the help of mouse or joystick (see [Configuring the Monitor for telemetry control](#)).
7. Configure the joystick for PTZ control (see [Configuring the joystick for telemetry control](#)).
8. Configure the mouse buttons to control PTZ device (see [Configuring the mouse buttons to control PTZ devices](#)).

Configuring Server ports and remote workstation to connect PTZ devices

PTZ devices are connected to the Server serial ports (COM). *Axxon PSIM™* allows connecting the required number of PTZ devices on demand.

Data exchange with a PTZ device is performed via the serial port (COM) in accordance with a specialized protocol. Each type of PTZ devices has its own exchange protocol. Only one exchange protocol can be selected for data exchange via the serial port (COM). Therefore, only one type of PTZ devices can be connected to one serial port (COM).

Several serial ports (COM) are configured one after another. Each type of serial ports (COM), used to connect the PTZ device, has the corresponding **Telemetry Controller** object created and configured in the **Hardware** tab of the **System settings** dialog box.

To configure the serial port (COM) used for connecting PTZ devices of the same type, do the following:

1. Go to the **Hardware** tab in the **System settings** dialog box (1).
2. Create the **Telemetry Controller** system object under the **Computer** object or select the corresponding object in the object tree in the **Hardware** tab of the **System settings** dialog box (2).

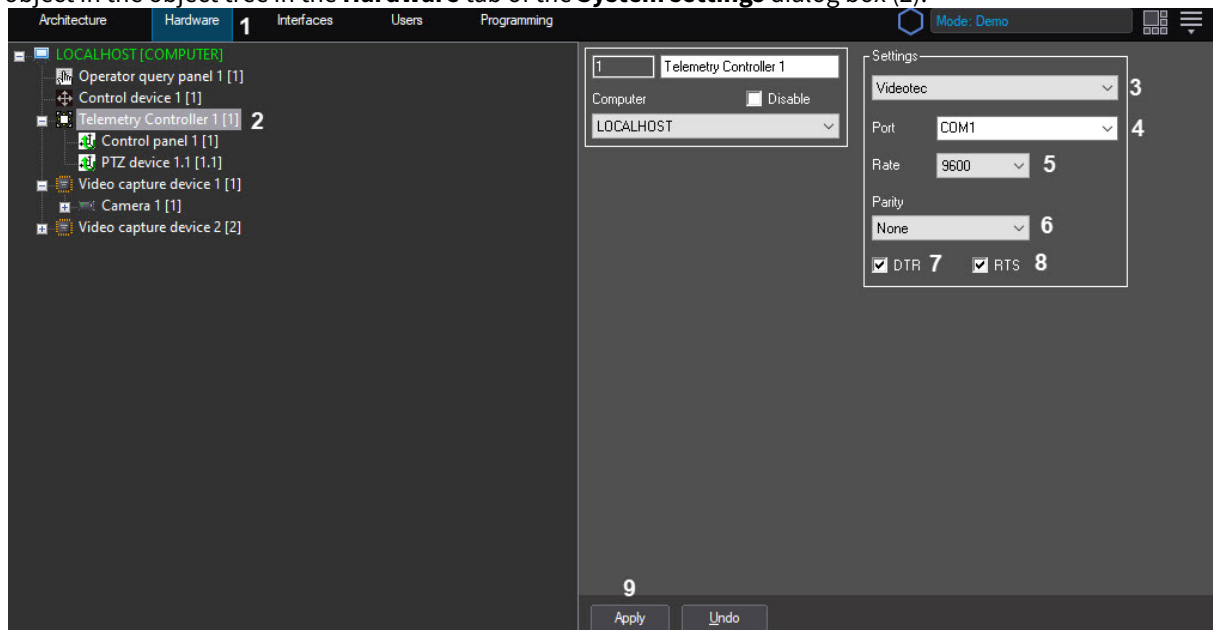

3. When the **Telemetry Controller** object is created, enter the ID, the name of the object and select the Server to the COM port of which the PTZ device is connected.

4. Select the protocol of data exchange with PTZ device in the list. The names of data exchange protocol in this list correspond to the names of PTZ types (3).
5. Select the serial port (COM) number in the **Port** list (4). If the device is connected via Ethernet (over a converter), enter the IP address and port to send telemetry commands using the selected protocol.

⚠ Important!

The port is to be selected only if the PTZ device is connected to the computer COM port. Otherwise, if PTZ control is to be performed on the IP device, select the **Remote COM port** value. PTZ control commands will be sent via the device driver and the RS-485 or RS-232 network address will be set on the settings panel of the **PTZ device** object (see [Configuring PTZ devices in Axxon PSIM™](#)).

ℹ Note.

If OKO telemetry system is in use, select the NM port number in the **Port** drop-down list (4).

6. Change the data exchange speed if necessary (5).

ℹ Note

Take into account that the data exchange speed via the COM port is specified by the vendor of PTZ device. The speed of data exchange with the PTZ device via the COM port must be the same as speed specified by the vendor.

ℹ Note

If you need to change the COM port settings, change the relevant COM port settings in the Windows OS (information on how to configure COM port in the Windows OS can be found in [Appendix 4. Technical specifications of video capture cards](#)).

7. Change the parity check parameters for the data exchange if necessary (6).
8. If PTZ devices are passive (i.e. with no power supply), the power supply of the PTZ devices must be activated via the DTR or RTS outputs of the COM port by setting the **DTR** or **RTS** checkboxes checked (7,8).
9. To save the changes, click the **Apply** button (9).

Configuring PTZ devices in Axxon PSIM™

The number of PTZ devices connected to the Server is specified in the license key bundled with *Axxon PSIM™* distribution kit.

Every PTZ device has the corresponding **PTZ device** system object in *Axxon PSIM™*. The **PTZ device** object is a child object to the **Telemetry Controller** object.

PTZ device configuration involves selection of the camera equipped with a PTZ device and setting PTZ MAC addresses. When the absolute telemetry is in use, you will also have to configure points calibration (see [Configuring calibration of points in camera FoV](#)).

Several PTZ devices are configured one after another.

To configure PTZ devices, do the following:

1. Go to the **Hardware** tab in the setting panel of *Axxon PSIM™* (1).

2. Create a **PTZ device** object under the **Telemetry controller** object or select the relevant object in the object tree in the **Hardware** tab of the **System settings** dialog box (2).

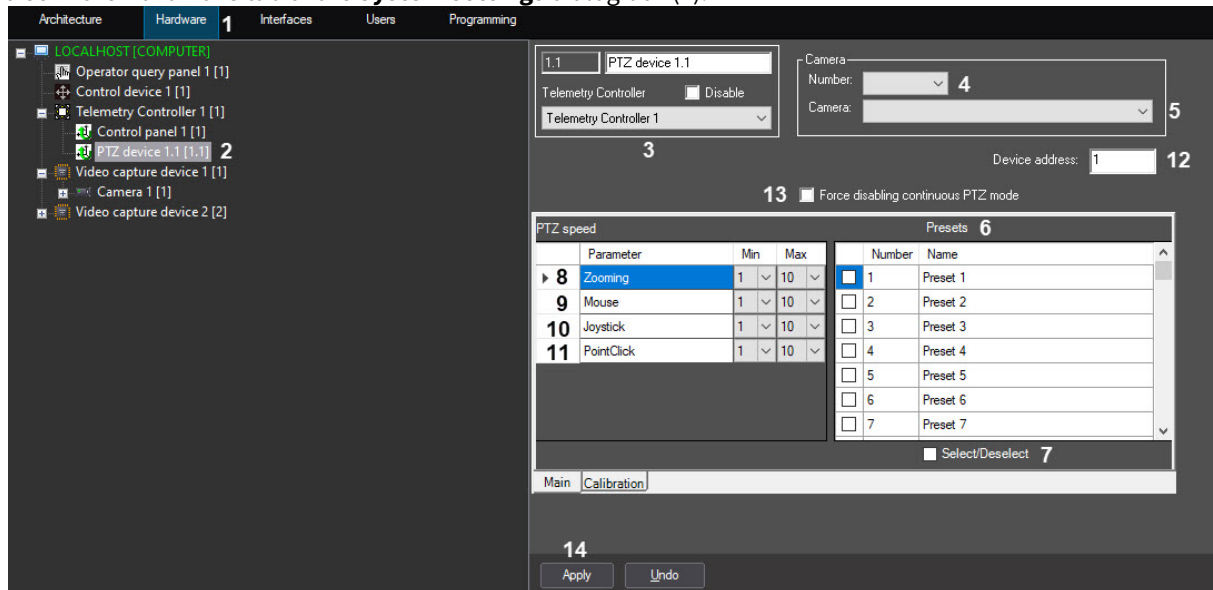

3. Specify the ID, the name of the **PTZ device** object and select the **Telemetry controller** object to which the PTZ device is connected (3).
4. Select the ID of the camera equipped with a PTZ device (4).
5. Select the name of the camera equipped with a PTZ device (5).

Note

Specify either the video camera ID or its name.

6. In the **Presets** table, set checkboxes checked next to the names of presets that are to be displayed on **Telemetry control panel** (see [Telemetry control panel configuration](#) section). Change the preset's name if necessary (6).

Note

In order to select all presets or cancel this operation, use the **Select/Deselect** checkbox (7). The maximum number depends on the device, see [Appendix 6. Maximum number of presets for IP devices](#).

7. Set minimal and maximal speed of optical zoom in standard units for PTZ device in the **Zooming** group (8).
8. Set minimal and maximal rotation speed in standard units for PTZ device while mouse control from the Monitor in the **Mouse** group (9).
9. Set minimal and maximal rotation speed while joystick control in the **Joystick** group (10)
10. Set minimal and maximal rotation speed of PTZ device in direction of mouse click (Point&Click) in standard units for PTZ device in the **Point&Click** group (11).
11. Specify the MAC address of the PTZ device in the **Device address** field. The PTZ MAC address corresponds to the address set on the PTZ device with the help of jumpers or configured while programming the PTZ device in the bundled software (12).
12. If the continuous PTZ mode (Continuous Mode) is to be disabled, set the **Force disabling continuous PTZ mode** checkbox checked (13).

Note.

If the checkbox is set unchecked, then the continuous PTZ mode is automatically enabled for the PTZ devices that support it.

13. To save the changes, click the **Apply** button (14).

3.4.4 Configuring Control panel

A telemetry control panel is used to control PTZ devices. The **Control panel** system object is used for the PTZ control panel hardware device registration in Axxon PSIM™.

 **Note.**

Some of the PTZ control panels may be registered as **Control device** – see [Configuring the Control Device object](#).

After the telemetry control panel is connected, registered and configured, the **Key pressed** event from the **Control panel** object is registered in the system at pressing a key on the panel, as well as other events depending on the control panel model – see subsections.

When connecting the telemetry control panel integrated into the Drivers Pack, you can use the [Camera discovery tool](#) to automatically register the **Control panel** object in *Axxon PSIM* similar to IP devices. Axis T8310 and Videotec DCZ control panels are integrated in this way at the time of writing this documentation. Their connection can also be configured and manually as described below. See the [Drivers Pack documentation](#) for the full list of control panels (CCTV Keyboards) for which you can use the Camera discovery tool.

To register and configure the **Control panel** object, do the following:

1. Go to the **Hardware** tab in the **System settings** dialog box (1).
2. Create the **Control panel** system object under the **Telemetry Controller** object or select the relevant object in the **Hardware** tab of the **System settings** dialog box (2).

 **Attention!**

If control panel is connected using the USB interface, then all settings related to COM-port are ignored by system. In this case, go to step 8.

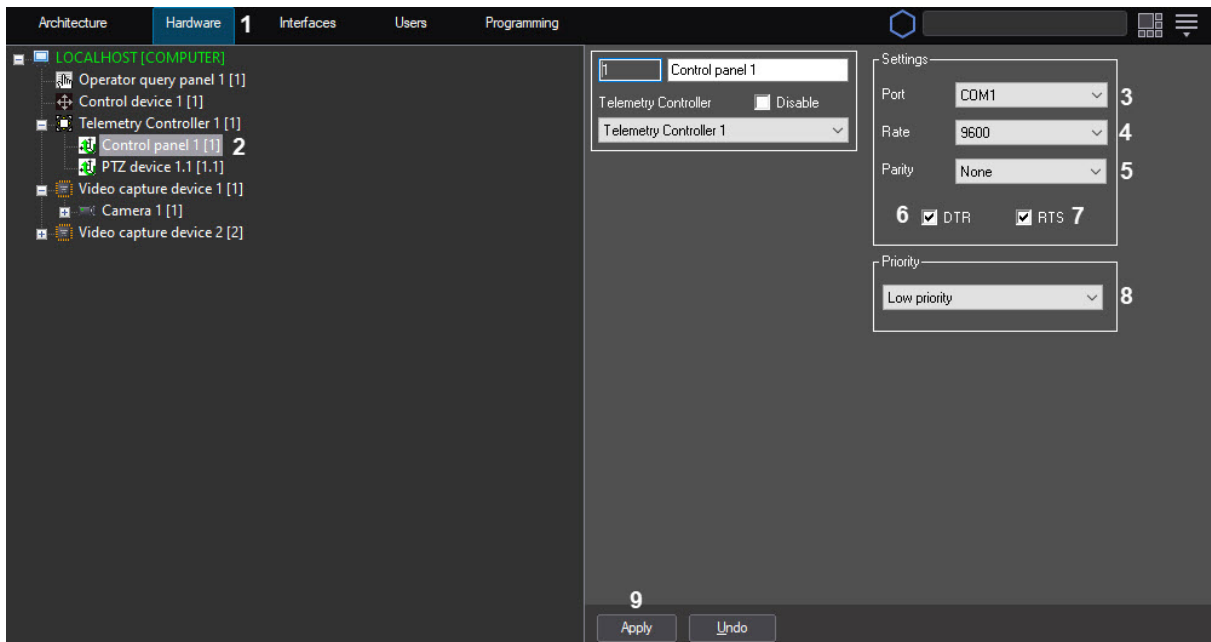

3. Specify the ID, the name of the **Control panel** object and select the **Telemetry controller** object to which the PTZ device is connected.
4. Select the COM port number in the **Port** list in order to connect the **Control panel** device (3).

Note

The Control panel is connected to the COM port different from that to which the PTZ device is connected. Therefore, another COM port number must be specified on the settings panel of the parent (for the **Control panel** object) **Telemetry Controller** object.

5. Specify the speed of data exchange between the computer and the telemetry control panel device, if necessary (4).
6. Specify parity check parameters for the data exchange if necessary (5).
7. If the telemetry control panel device is passive (i.e. with no independent power supply), the power supply is to be activated via the DTR or RTS outputs of the COM port by setting the **DTR** or **RTS** check boxes (6,7).

Note

The COM port speed and parity settings of the parent Telemetry controller object do not relate to the similar settings of the **Control panel** object, as they refer to another COM port.

Note

The **Speed** and **Parity** settings must be the same as the COM port settings in the Windows OS.

8. To change the PTZ device control priority for the telemetry control panel device, select the relevant item in the **Priority** list (8).
9. To save the changes, click the **Apply** button (9).

Features of BOSCH KBD-Digital or BOSCH KBD-Universal control panel configuration and operation

On the page:

- [Configuring BOSCH KBD-Digital or BOSCH KBD-Universal control panel in Axxon PSIM™](#)
- [Features of BOSCH KBD-Digital or BOSCH KBD-Universal control panel operation in Axxon PSIM™](#)
- [Example of JScript script](#)

Configuring BOSCH KBD-Digital or BOSCH KBD-Universal control panel in Axxon PSIM™

Configure BOSCH KBD-Digital or BOSCH KBD-Universal control panel in *Axxon PSIM™* as follows:

1. Create the **Telemetry Controller** object.

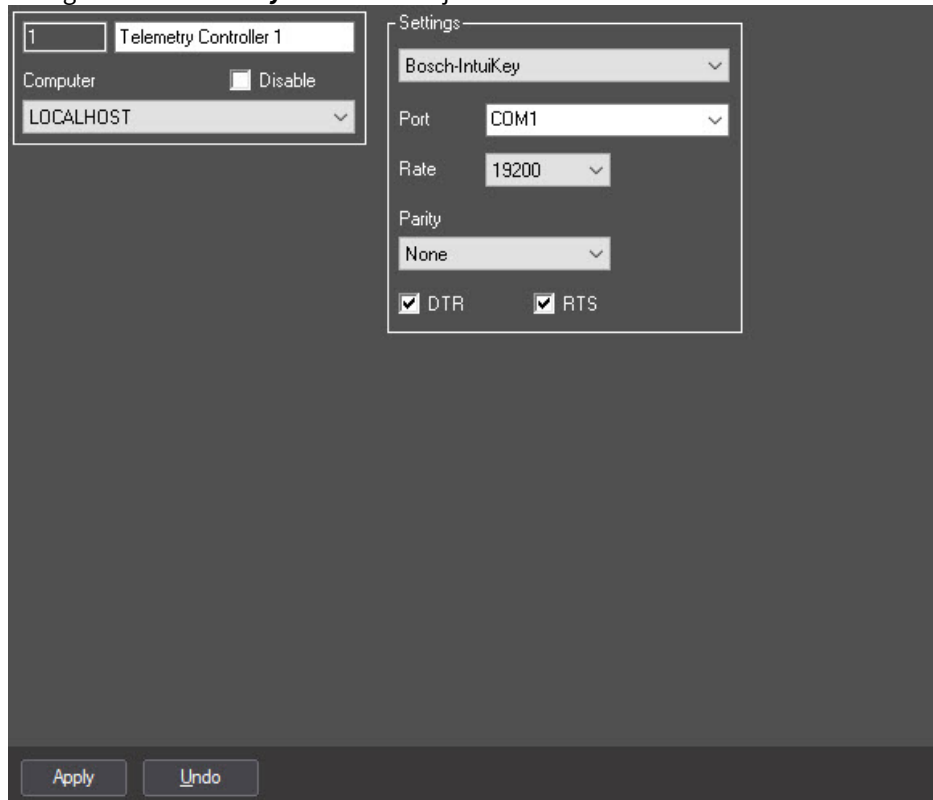
2. Configure the **Telemetry Controller** object as follows:

- a. Set the **Bosch-IntuiKey** interface protocol.
 - b. Select the COM port in the **Port** list.
 - c. Set **19200** value to the **Rate** parameter.
 - d. Set the **None** value for the **Parity** parameter.
 - e. Set the **DTR** and **RTS** checkboxes checked.
3. Create the **Control panel** system object under the **Telemetry Controller** object.
 4. Configure the **Control panel** object as described in [Configuring Control panel](#) section.

BOSCH KBD-Digital or BOSCH KBD-Universal control panel is now configured in *Axxon PSIM™*.

Features of BOSCH KBD-Digital or BOSCH KBD-Universal control panel operation in *Axxon PSIM™*

⚠ Attention!

Before you start using BOSCH KBD-Digital or BOSCH KBD-Universal control panel in *Axxon PSIM™*, switch it to the **Terminal mode**. For this, press the **Prod** key and select **Terminal** on the monitor.

ℹ Note

Detailed information on BOSCH KBD-Digital or BOSCH KBD-Universal control panel is given in official reference documentation on this device.

When the key is pressed on BOSCH KBD-Digital or BOSCH KBD-Universal control panel there is **Key is pressed** or **Key is released** message in *Axxon PSIM™*.

Event	Message	Parameter	Description
KEY_PRESSED	Key pressed	param0	Code of pressed key
KEY_RELEASED	Key released	param0	Code of released key

In the comments to these events the code (param0) of pressed and released key is specified.

Note

With long key pressing (more than 500 milliseconds) the **Key is pressed** event is repeated with 100 milliseconds interval. Releasing the key one **Key is released** message is received.

Key codes of BOSCH KBD-Digital or BOSCH KBD-Universal control panel:

Key	Key code	Key	Key code
SOFTKEY 1L	0x01	4	0x34
SOFTKEY 2L	0x02	5	0x35
SOFTKEY 3L	0x03	6	0x36
SOFTKEY 4L	0x04	7	0x37
SOFTKEY 5L	0x05	8	0x38
SOFTKEY 6L	0x06	9	0x39
SOFTKEY 7L	0x07	MONITOR	0x20
SOFTKEY 1R	0x08	PRODUCT	0x21
SOFTKEY 2R	0x09	CLEAR	0x22
SOFTKEY 3R	0x0A	IRISA	0x23
SOFTKEY 4R	0x0B	IRISB	0x24
SOFTKEY 5R	0x0C	ACK	0x25
SOFTKEY 6R	0x0D	ENTER	0x26

SOFTKEY 7R	0x0E	SHOT	0x27
0	0x30	FOCUSA	0x28
1	0x31	FOCUSB	0x29
2	0x32	0 + 1	0x81
3	0x33	MONITOR + CLEAR	0x82

The following special features are available for *BOSCH KBD-Digital* or *BOSCH KBD-Universal* control panel:

1. **Paint figure** (set by **Figure**, **Type of painting**, **Paint figure**, **original Y-coordinate**, **end Y-coordinate**, **original X-coordinate**, **end X-coordinate** and **Screen**).
2. **Clear screen** (set by **Screen** parameter).
3. **Type text** (set by **X-coordinate**, **Y-coordinate**, **Coding**, **Style**, **Screen** and **Text** parameters).

Note

Bold text is displayed only on the status display.

Example of JScript script

[bosch.txt](#) and [bosch_menu.txt](#) files are available when clicking the links.

[bosch_menu.txt](#) file consists of Jscript script that, when initiated by macro, displays the menu on the *BOSCH KBD-Digital* or *BOSCH KBD-Universal* telemetry control panel. This menu shows the correspondence of *keys of BOSCH KBD-Digital* or *BOSCH KBD-Universal* control panels to the actions they perform. This script is to be run just once.

[bosch.txt](#) file consists of Jscript script that assigns actions to *keys of BOSCH KBD-Digital* or *BOSCH KBD-Universal* control panels as follows:

Key	Code (denary)	Code (hexadecimal)	Action
SOFTKEY 1L	1	0x01	Display 1 video surveillance window on the monitor
SOFTKEY 2L	2	0x02	Display 4 video surveillance windows on the monitor
SOFTKEY 3L	3	0x03	Display 9 video surveillance windows on the monitor
SOFTKEY 4L	4	0x04	Display all video surveillance windows
SOFTKEY 5L	5	0x05	Rewind
SOFTKEY 6L	6	0x06	Playback

SOFTKEY 7L	7	0x07	Go to the archive playback mode
SOFTKEY 1R	8	0x08	Export frame
SOFTKEY 2R	9	0x09	Print frame
SOFTKEY 3R	10	0x0A	Run macro 2
SOFTKEY 4R	11	0x0B	Run macro 3
SOFTKEY 5R	12	0x0C	Forward wind
SOFTKEY 6R	13	0x0D	Stop playback
SOFTKEY 7R	14	0x0E	Go to the video surveillance mode
MONITOR	32	0x20	Specify monitor ID
ACK	37	0x25	Display menu (run macro 1)
ENTER	38	0x26	Specify camera ID
SHOT	39	0x27	Go to preset

Example of how to use script.

Task: to display camera 2 on the monitor 1 and go to preset 3.

Note.

Preset 3 is to be saved, for example using the [PTZ control with Universal PTZ control panel](#).

1. Click the 1 button, then click the MONITOR button. The information about current monitor number is displayed on the display of the control panel.
2. Click the 2 button on the control panel, then click the ENTER button. As a result, camera 2 is displayed on the monitor 1, and information about current camera number is displayed on the display of the control panel.
3. Click the 3 button on the control panel, then click the STOP button. As a result, camera 2 switches to preset 3, and information about current preset number is displayed on the display of the control panel.

Features of Axis T8310 control panel configuration and operation

On the page:

- [General information](#)
- [Features of Axis T8310 control panel operation in Axxon PSIM](#)
- [Example of script in JScript](#)

General information

Two versions of Axis T8310 control panel are integrated with *Axxon PSIM*: Rev01 and Rev02. The setup and operation procedure for these versions in *Axxon PSIM* is similar.

It is not recommended to connect control panels of both versions to *Axxon PSIM* at the same time to avoid incorrect operation of the system.

The control panel can be added to *Axxon PSIM* as a control device – see [Configuring the Control device object](#). In this case, events on pressing keys, changing the position of the joystick, etc. in the Event Viewer are received from the **Control Device** object.

Configuring Axis T8310 control panel in Axxon PSIM

Configure Axis T8310 control panel in Axxon PSIM as follows:

1. Create the **Telemetry controller** object.

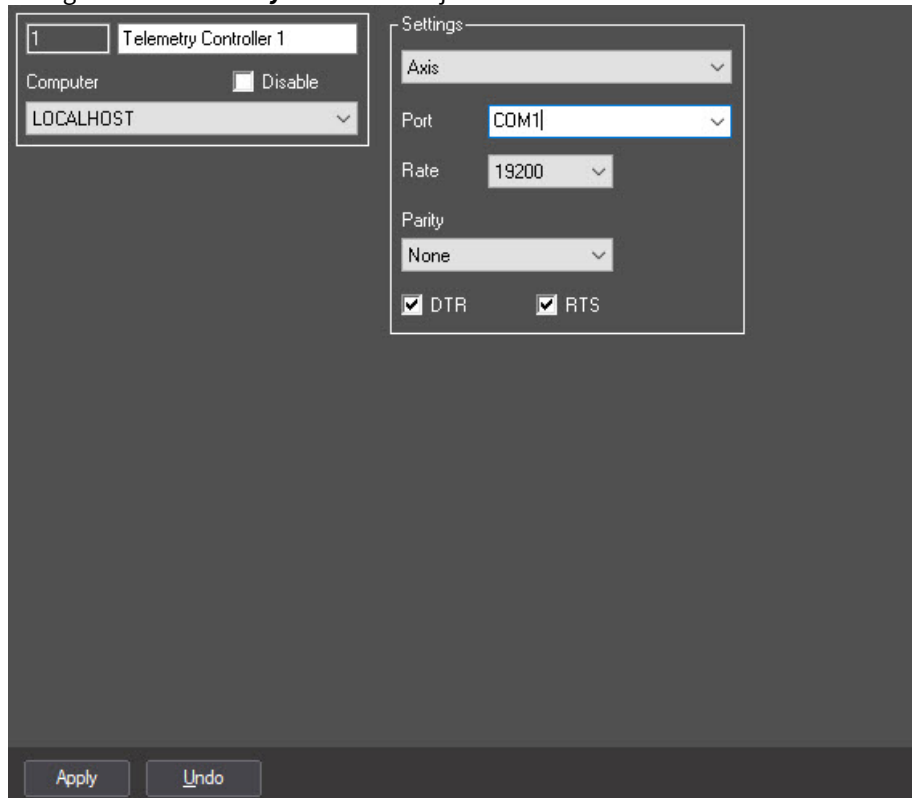
2. Configure the **Telemetry controller** object as follows:

- a. Set the **Axis** interface protocol.
- b. Other settings of this object are ignored by system because the control panel of *Axis T8310* telemetry is connected to the Server using USB interface.
3. Create the **Control panel** system object under the **Telemetry controller** object.
4. Configure the **Control panel** object as described in [Configuring Control panel](#) section.
5. If Rev01 panel is in use, restart Axxon PSIM

Axis T8310 control panel is now configured in Axxon PSIM.

Features of Axis T8310 control panel operation in Axxon PSIM

Note.

Detailed information on Axis T8310 control panel is given in official reference documentation on this device

Pressing the key on Axis T8310 control panel there is **Key is pressed** or **Key is released** message in *Axxon PSIM*.

AXIS T8310 control panel is a modular system that consists of three devices:

1. AXIS T8311 joystick. This device has functionality of an ordinary joystick and it is configured in the standard way (see [Configuring the joystick for telemetry control](#) section). The device also has 6 hot keys.

Note.

By default, the image zooms out if z axis is rotated right (in clockwise order) and zooms in if z axis is rotated left (counterclockwise) while the telemetry is controlled in the Monitor using Axis 8311 joystick.

2. AXIS T8312 keyboard has 10 hot keys and 12 programmed keys.
3. AXIS T8313 Jog Dial has 6 hot keys and a navigation wheel.

The panel model varies depending on the connected [devices](#).

T8310	All devices
T8311	Joystick only
T8311/T8312	Joystick and keypad
T8311/T8313	Joystick and jog dial
T8312	Keypad only
T8312/T8313	Keypad and jog dial
T8313	Jog dial only

If complete AXIS T8310 control panel is used, then modules are connected to each other via AXIS T8312 keyboard (USB hub).

Functions of control panel related to pressing keys can be performed with the help of following:

1. scripts in JScript (see details on how to create scripts in [Programming Guide \(JScript\)](#));
2. programs in internal language in Axxon PSIM;
3. macros (see [Creating and using macros](#)).

Pressing the key on the keyboard of AXIS T8310 control panel in Axxon PSIM there is **Key is pressed** or **Key is released** message.







Description of 'Key is pressed' and 'Key is released' messages:

Event	Message	Parameter	Description	Value range
KEY_PRESSED	Key pressed	param0	Code of pressed key	0..21
		device	Device with pressed key.	0 - AXIS T8312 main keyboard, 1 - AXIS T8313 keyboard
KEY_RELEASED	Key pressed	param0	Code of released key	0..21

Event	Message	Parameter	Description	Value range
		device	Device with released key	0 - AXIS T8312 main keyboard, 1 – AXIS T8313 Jog Dial

The **Control panel** object (TELEMETRY_EXT) is the issuer of these events. In the comment to these events the code of pressed and released key is specified.

Key codes of AXIS T8312 control panel:

Key	Key code	Key	Key code
0	0	Alt	11
1	1		12
2	2		13
3	3		14
4	4		15
5	5		16
6	6	F1	17
7	7	F2	18
8	8	F3	19
9	9	F4	20
	10	F5	21

Note.

Control panel key codes and the event issuer depend on the panel firmware.

When the position of AXIS T8313 joystick is changed, the *Axxon PSIM* receives the **Position is changed** message.

Description of **Position is changed** message:

Event	Message	Parameter	Description	Value range
MOVED	Position changed	param0	Offset value	JogDial -1.. 1; shuttle -8..7
		device	'AXIS T8313' type of control-gear	0 – JogDial, 1 – shuttle







The following special features are available for AXIS T8310 control panel:

1. Switch on relay (set by **Relay identifier** parameter). This command allows switching on the light on the key with light (12-16).
2. Switch off relay (set by **Relay identifier** parameter). This command allows switching off the light on the key with light (12-16).



Example of script in JScript

The [link](#) provides the file containing the script on JScript, which allows assigning actions to the keys of the AXIS T8310 telemetry control panel as follows:

Axis T8312



Key	Action
F1	1-CAM layout
F2	4-CAM layout
F3	9-CAM layout
F4	16-CAM layout
F5	25-CAM layout
	Monitor ID
	Camera ID
	Go to preset
	not used
	Save preset
	Switch between live-view & archive
Alt	not used

Axis T8313

Key	Action
	standart controls
[L]	export frame
[R]	export arch
	<p>Outer control = increase/decrease camera surveillance window size</p> <p>Inner control = next/previous</p>

Usage example:

1. To activate Camera 3 on Monitor 12 do the following:

- a. Press 12 then  .
 - b. Press 3 then  .
2. To go to preset #2 do the following:
- a. Press 2 then  .

Features of Lilin PIH-800III control panel configuration and operation

On the page:

- [Configuring Lilin PIH-800III telemetry control panel](#)
- [Using Lilin PIH-800III telemetry control panel](#)

Configuring Lilin PIH-800III telemetry control panel

Configure the *Lilin PIH-800III* telemetry control panel in the *Axxon PSIM* as follows:

1. Create the **Telemetry controller** object.
1. Configure the **Telemetry controller** object as follows:

The screenshot displays the configuration window for a Telemetry Controller. On the left, the object is named 'Telemetry Controller 1' and is associated with the computer 'LOCALHOST'. A 'Disable' checkbox is present. The 'Settings' panel on the right is expanded, showing the following parameters:

- Protocol: Lilin PIH-7000/7600
- Port: COM1
- Rate: 9600
- Parity: None
- DTR:
- RTS:

'Apply' and 'Undo' buttons are located at the bottom of the configuration window.

2. Specify the **Lilin PIH-7000/7600** communication protocol.

Note.

In order to transmit directly data to Lilin cameras connected via a serial port, select the **Lilin PIH-7000/7600 Direct** communication protocol. However, the full functionality of these cameras can be used, even what is not supported by *Axxon PSIM*.

3. In the **Port** list, specify the number of the serial (COM) port for connecting to the telemetry controller.
4. Specify **9600** value for the **Rate** parameter.
5. Specify **None** value for the **Parity** parameter.
6. Set the **DTR** and **RTS** checkboxes checked.
 - Create the **Control panel** object under the **Telemetry controller** object.
 - Configure the **Control panel** object as described in [Telemetry control panel configuration](#) section.

Lilin PIH-800III telemetry control panel is now configured in *Axxon PSIM*.

Using *Lilin PIH-800III* telemetry control panel

Some of *Lilin PIH-800III* telemetry control panel's keys correspond to standard functions in *Axxon PSIM*.

Note.

The functionality of these keys is also described in the reference documentation on *Lilin PIH-800III* control panel.

Key	Function
ZOOM IN / ZOOM OUT	Increases/decreases the size of the image
FOCUS FAR / FOCUS NEAR	Increases/decreases the focal distance of the lens
IRIS O / IRIS C	Opens/closes the aperture
AUTOFOCUS	Sets the focal distance of the lens automatically
AUTOIRIS	Automatically selects the position of the aperture
AUTOPAN	Switches the pan head to auto-pan mode; or switches a dome camera to auto-patrol mode
PRESET	Switches to a preset; saves a preset
PRESET 1/2/3/4	Switches to preset 1/2/3/4

Some of *Lilin PIH-800III* control panel's keys can be used through the KEY_PRESSED event. *Axxon PSIM* receives the **KEY_PRESSED** event when these keys are pressed on *Lilin PIH-800III* telemetry control panel's keyboard.

Event	Message	Parameter	Description
KEY_PRESSED	A key was pressed	param0	Code the key that was pressed

The source of this event is the **Control panel** object (TELEMETRY_EXT). The event's documentation indicates the code of the key that was pressed (param0). The key code for entering a number (1, 2, or 4 digits) is equal to the number entered. A four-byte hexadecimal code is used for function keys.

Key	Code	Hexadecimal code
ESC	1769472	0x001B0000
LIGHT	655360	0x000A0000
CTRL1	851969	0x001A0000
CTRL2	851970	0x00090000
CLR	3604480	0x00370000
ENT	3538944	0x00360000
WIPER	786432	0x000C0000
SPRAY	720896	0x000B0000

No messages are sent to *Axxon PSIM* when the F1-F4, MON and CAM keys are pressed.

Control panel functions associated with the execution of actions in *Axxon PSIM* when events arrive from the control panel can be implemented using the following resources:

1. Scripts written in the JScript programming language (see [Programming Guide \(JScript\)](#) for more information on how to create scripts);
2. Programs written in internal programming language in *Axxon PSIM*;
3. Macros (see [Creating and using macros](#) in *Administrator's Guide* for more information).

Features of Panasonic WV-CU950 control panel configuration and operation

On the page:

- [Configuring Panasonic WV-CU950 control panel in Axxon PSIM™](#)
- [Features of Panasonic WV-CU950 control](#)

- panel operation
in Axxon PSIM™
- Example of JScript script

Configuring Panasonic WV-CU950 control panel in Axxon PSIM™

Panasonic WV-CU950 control panel is connected using 4-wired version of RS-485 interface. Before connecting *Panasonic WV-CU950* control panel, make sure that the MODE switches are set to the position corresponding to connection via RS-485 protocol: switches number 1 and number 5 are to be set to ON, the rest to OFF. See details on how to set switches in the reference documentation.

Configure *Panasonic WV-CU950* control panel in *Axxon PSIM™* as follows:

1. Create the **Telemetry controller** object.
2. Configure the **Telemetry controller** object as follows:

The screenshot shows a configuration window for a Telemetry Controller. The title bar reads '1 Telemetry Controller 1'. Below the title bar, there is a 'Computer' field with a 'Disable' checkbox and a dropdown menu showing 'LOCALHOST'. To the right, a 'Settings' panel contains several configuration options: a dropdown menu for 'Panasonic PS-Data', a 'Port' dropdown menu set to 'COM1', a 'Rate' dropdown menu set to '9600', a 'Parity' dropdown menu set to 'None', and two checked checkboxes for 'DTR' and 'RTS'. At the bottom of the window, there are 'Apply' and 'Undo' buttons.

- a. Set the **Panasonic PS-Data** interface protocol.
 - b. Select the COM port in the **Port** list.
 - c. Set **9600** value for the **Rate** parameter.
 - d. Set the **None** value for the **Parity** parameter.
 - e. Set the **DTR** and **RTS** checkboxes checked.
3. Create the **Control panel** system object under the **Telemetry controller** object.
 4. Configure the **Control panel** object as described in [Configuring Control panel](#) section.

Panasonic WV-CU950 control panel is now configured in *Axxon PSIM™*.

Features of Panasonic WV-CU950 control panel operation in Axxon PSIM™

Pressing the key on Panasonic WV-CU950 control panel there is **Key pressed** or **Key released** message in *Axxon PSIM™*.

Description of 'Key pressed' and 'Key released' messages:

Event	Message	Parameter	Description
KEY_PRESSED	Key pressed	param0	Code of pressed key
KEY_RELEASED	Key released	param0	Code of released key

The **Cotrol panel** object (TELEMETRY_EXT) is the source of these events. In the comment to these events the code of pressed and released key is specified.

Key codes of Panasonic WV-CU950 control panel:

Key	Key code	Key	Key code
1	'1'	30	'T'
2	'2'	31	'U'
3	'3'	32	'V'
4	'4'	33	'W'
5	'5'	34	'X'
6	'6'	35	'Y'
7	'7'	36	'Z'
8	'8'	37	'a'
9	'9'	38	'b'
10	'0'	39	'c'
11	'A'	40	'd'
12	'B'	41	'e'
13	'C'	42	'f'

Key	Key code	Key	Key code
14	'D'	43	'g'
15	'E'	44	'h'
16	'F'	45	'i'
17	'G'	46	'j'
18	'H'	47	'k'
19	'I'	48	'l'
20	'J'	49	'm'
21	'K'	50	'n'
22	'L'	51	'o'
23	'M'	52	'p'
24	'N'	53	'q'
25	'O'	54	'r'
26	'P'	55	's'
27	'Q'	56	't'
28	'R'	57	'u'
29	'S'		

When the position of Panasonic WV-CU950 joystick is changed, then there is the **Position changed** message.

Description of Position changed message:

Event	Message	Parameter	Description	Value range
MOVED	Position changed	param0	Offset value	JogDial -1.. 1; shuttle -6..6

		device	Type of control-gear	0 – JogDial, 1 – shuttle
--	--	--------	----------------------	-----------------------------

Functions of control panel related to pressing keys can be performed with the help of following:

1. scripts in JScript (see details on how to create scripts in [Programming Guide \(JScript\)](#));
2. programs in internal language in Axxon PSIM;
3. macros (see details in [Administrator's Guide, Creating and using macros](#) section).

The following special features are available for Panasonic WV-CU950 control panel using macros:

1. **Clear screen** – allows clearing the device screen.
2. **Type text** (set by Y coordinate, Text and Indication parameters) – displaying text with certain position and indication on the device screen.
3. **Set alarm** (set by Audio alarm parameter). Set alarm signal type.
4. **Switch on relay** (set by Relay identifier parameter). This command allows switching on the indicator.
5. **Switch off relay** (set by Relay identifier parameter). This command allows switching off the indicator.
6. **Reboot** (set by Reboot type parameter). Allows rebooting the device immediately or after a time period.

Example of JScript script

The file with JScript can be found [here](#). It allows assigning actions to Panasonic WV-CU950 control panel keys:

Key	Function
K	Continuous playback/pause
J	Stop playback
I	Switch to the archive playback mode/view live video mode
N	Clear control panel display
n	Enter key emulation
A	Set the Video surveillance monitor ID
B	Set the camera ID
D	Go to the preset
F	Record preset
i	Layout with 1 camera
j	Layout with 4 cameras

k	Layout with 9 cameras
l	Layout with 16 cameras
Shifting wheel of rotary control	Rewind/fast forward playback
Shifting frame-by-frame wheel	Maximize/minimize the Surveillance window

Features of Samsung SSC-2000 control panel configuration and operation

Configure Samsung SSC-2000 telemetry control panel in *Axxon PSIM* as follows:

1. Create the **Telemetry controller** object.
1. Configure the **Telemetry controller** object as follows:

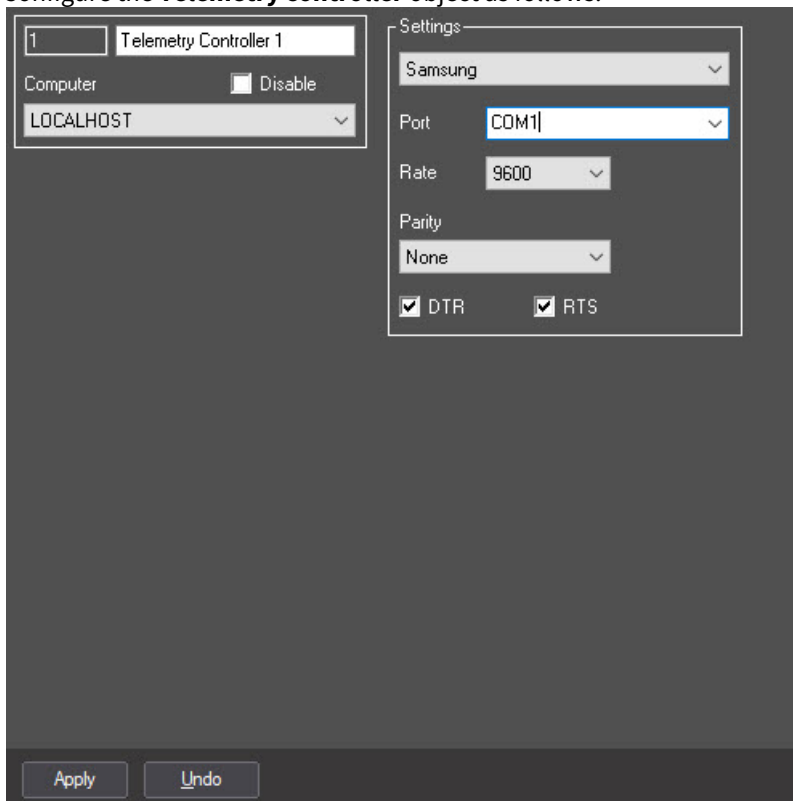

2. Specify the **Samsung** communication protocol (1).
3. In the **Port** list, select the number of the serial (COM) port for connecting to the telemetry controller (2).
4. Specify **9600** value for the **Rate** parameter (3).
5. Specify **None** value for the **Parity** parameter (4).
6. Set the **DTR** and **RTS** checkboxes checked (5,6).
 - Create the **Control panel** object under the **Telemetry controller** object.
 - Configure the **Control panel** object as described in [Telemetry control panel configuration](#) section.

Samsung SSC-2000 telemetry control panel is now configured in *Axxon PSIM*.

Features of EverFocus EKB200 control panel configuration

Configure *EverFocus EKB200 telemetry control panel* in *Axxon PSIM* as follows:

1. Create the **Telemetry Controller** object.

Note.

You can leave default settings of the **Telemetry Controller** object.

2. Create the **Control panel** object.
3. Select **EverFocus EKB200** in the **Port** field (1).

Note.

As the control panel is connected to the computer via USB, then you can leave default **Rate**, **Parity**, **DTR** and **RTS** settings.

4. To apply settings, click the **Apply** button (2).

Even if there are no PTZ cameras in the system, there will be events (when buttons are pressed and the joystick position is changed) from the **Control panel** object corresponding to EverFocus EKB200 telemetry control panel. These events will be displayed in the event log and they can be used in scripts and macros (see also [TELEMETRY_EXT](#) in [Programming Guide](#)).

EverFocus EKB200 telemetry control panel is now configured.

Features of Samsung SPC-7000 control panel configuration

On the page:

- [Configuring Samsung SPC-7000 control panel](#)
- [Example of script in JScript](#)

Configuring Samsung SPC-7000 control panel

Configure *Samsung SPC-7000* telemetry control panel in *Axxon PSIM* as follows:

1. Create the **Telemetry control panel** object.

Note.

You can leave default settings of the **Telemetry control panel** object.

2. Create the **Control panel** object.

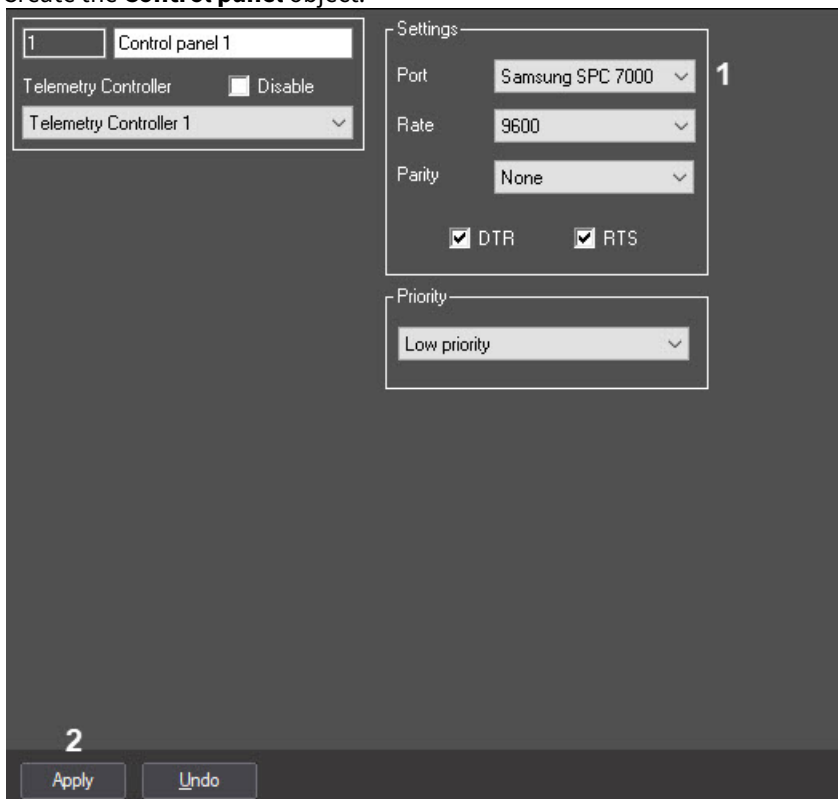

The screenshot displays the configuration window for a control panel. On the left, there is a list of objects with 'Control panel 1' selected. Below it, the 'Telemetry Controller' is set to 'Telemetry Controller 1' and is disabled. The main 'Settings' section on the right includes:

- Port:** Samsung SPC 7000 (marked with a '1')
- Rate:** 9600
- Parity:** None
- DTR:**
- RTS:**
- Priority:** Low priority

 At the bottom left of the window, there is a '2' and buttons for 'Apply' and 'Undo'.

3. Select **Samsung SPC-7000** in the **Port** field (1).

Note.
As the control panel is connected to the computer via USB, then you can leave default **Speed**, **Parity**, **DTR** and **RTS** settings.

4. To apply the changes, click the **Apply** button (2).

Samsung SPC-7000 panel is now configured.

Example of script in JScript

The [link](#) provides the file containing the script on JScript, which allows assigning actions to the keys of the Samsung SPC-7000 telemetry control panel as in the manufacturer’s manual.

Features of using VIDEOTEC DCZ keyboard

This keyboard is connected to Axxon PSIM as a standard joystick – see [Configuring the joystick for telemetry control](#). When connecting the keyboard to the computer, it is necessary to press SET + 5 keys on it, in this case it will be defined by the system as a USB gaming device. There is no need to create a Control panel object under the Telemetry controller object.

The figure below shows the correspondence of the key codes to the buttons on the keyboard.

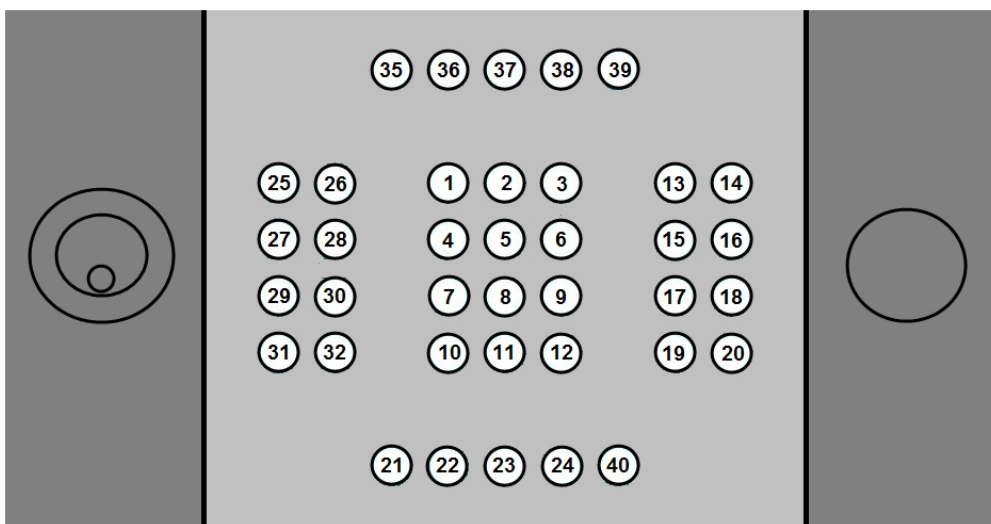

Important!
External left joystick is not supported in Axxon PSIM.

The right joystick allows controlling the rotation of the camera lens along the X, Y, Z axes.

When pressing keyboard buttons, Axxon PSIM receives events of the following form:

TELEMETRY|1.1||joystick<1>,button <29>,tel_prior <1>,monitor <1>,speed <0>,cam <1>,operator <>,vy <0>,vx <0>

Important!
By default, the keyboard automatically sends ZOOM_IN and ZOOM_OUT commands to the Axxon PSIM when 1 or 2 keys are pressed. For proper operation of the keyboard, it is necessary to reset the command values for the keyboard buttons. For this, create **empty** string values **1, 2, 3, 4, 5, 6, 7** and **8** in the HKEY_LOCAL_MACHINE\SOFTWARE\Wow6432Node\AxxonSoft\Axxon PSIM\Telemetry branch for the 64-

bit system (HKEY_LOCAL_MACHINE\SOFTWARE\AxxonSoft\Axxon PSIM\Telemetry for 32-bit) on the computer to which the keyboard is connected.

Actions are assigned to pressed buttons using a script or program (find more information on creating scripts in [Programming Guide \(JScript\)](#)). The example of this script can be downloaded [here](#).

This example assigns the following actions to the buttons of the keyboard:

Key code	Action
10	Activate previous camera
12	Activate next camera
13	Focus in
14	Focus out
15	Enable auto focus
16	Set preset number
18	Delete preset number
21	Activate layout wit 1 camera
22	Activate layout wit 4 cameras
23	Activate layout wit 9 cameras
24	Activate layout wit 16 cameras
40	Activate layout wit all cameras
25	Go to the live video mode
26	Go to archive mode
32	Start patrolling

3.4.5 Configuring PTZ IP cameras

Configuration of PTZ IP cameras differs from that of other PTZ devices.

PTZ IP cameras are connected via the local net via the TCP/IP transport protocol. Uniform communication protocol is used for all PTZ IP cameras.

Configure the **Telemetry Controller** object as follows:

1. Go to the **Hardware** tab in the **System settings** dialog box (1).
2. Create the **Telemetry Controller** system object under the **Computer** object or select the relevant object in the **Hardware** tab of the **System settings** dialog box (2).

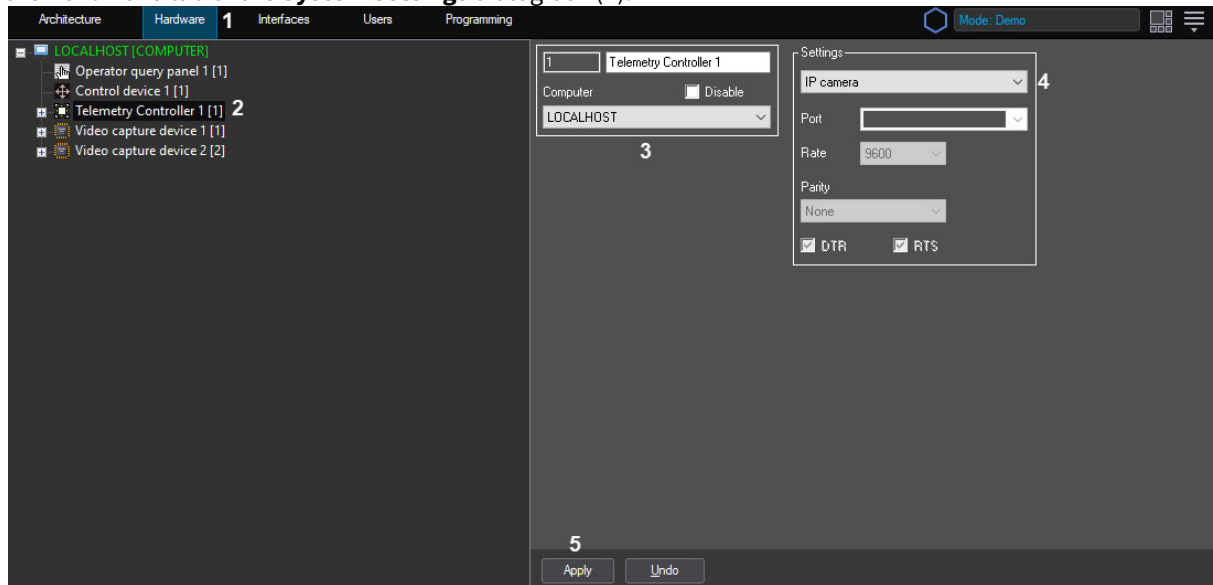

3. Specify the ID, the name of the **Telemetry Controller** object and select the Server connected with the PTZ device (3)
4. Select the data exchange protocol in the list. To use TCP/IP protocol for the data exchange with a PTZ IP camera, select **IP camera** as the protocol (4).

Note
When the **IP camera** item is selected on the **Settings** panel of the **Telemetry Controller** object, the other settings cannot be changed.

Note
If **Bosch VG5 AutoDome 700 Series** camera is in use, select the **Bosch-Autodome 1.0** protocol, for **Bosch VG4 AutoDome** and **Bosch VG5 AutoDome 800 Series** cameras select **Bosch-Autodome 4.0**.

5. To save all the changes, click the **Apply** button (5).

Note
The **PTZ device** object configuration for PTZ IP camera control is the same as for control over PTZ devices when they are connected via the Server's COM port.

Configuring control of PTZ IP camera using the control panel

To control the PTZ IP camera using the control panel connected via COM-port create two **Telemetry controller** objects:

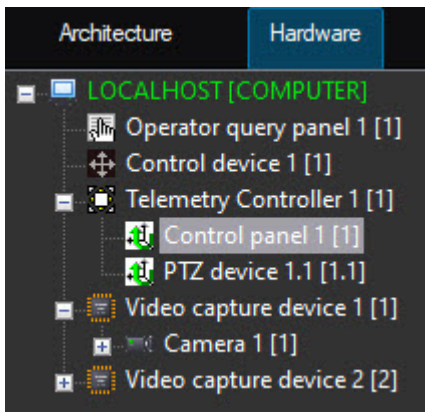

1. With the **Control panel** child object. Configure the **Telemetry controller** object depending on connected control panel as described in the corresponding section, see [Configuring Control panel](#).
2. With the **PTZ device** child object. Configure the **Telemetry controller** as described in the [Configuring PTZ IP cameras](#) section, and configure the **PTZ device** child object as described in the [Configuring PTZ devices in Axxon PSIM™](#) section.

Features of Vivotek Panoramic PTZ configuration

Vivotek Panoramic PTZ functional supports Vivotek SF8172 and Vivotek SF 8172V fish-eye cameras and Vivotek SD8362E PTZ camera.

Information on how to install these cameras and configure connection between them for proper operation of Vivotek Panoramic PTZ functional is given in the official documentation that is available on the Vivotek's website: <http://www.vivotek.com/panoramic%20ptz/>

For Vivotek Panoramic PTZ functional operation in the object tree create and configure the following objects corresponding to connected cameras:

1. Two **Video Capture Device** objects (information on how to configure these objects is in the [Configuring video acquisition from IP devices](#) section).
2. Two **Camera** objects under the **Video Capture Device** objects corresponding to connected cameras.
3. Two **Telemetry controller** objects (information on how to configure these objects is in the [Configuring PTZ IP cameras](#) section).
4. Two **PTZ device** objects under the **Telemetry controller** objects, corresponding to created cameras (information on how to configure these objects is in the [Configuring PTZ devices in Axxon PSIM™](#) section).

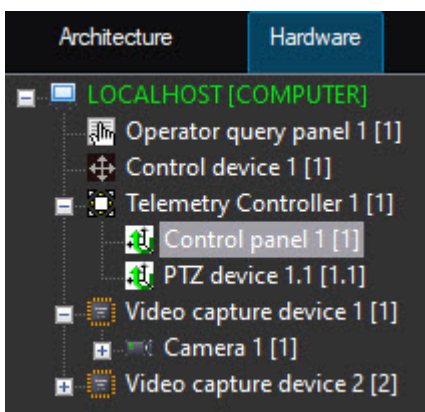

It is also required to configure **Monitor** and **Telemetry control panel** interface objects to control PTZ devices (see [Configuring the Monitor for telemetry control](#) and [Telemetry control panel configuration](#) sections).

When all required objects are configured, telemetry control on Fish-eye cameras using AreaZoom and Point&Click functions are available (detailed information on how to use these functions is given in the [Mouse PTZ control](#) section of [Operator's Guide](#) document).

3.4.6 Telemetry control panel configuration

Telemetry control panel is an interface object for PTZ device control. The telemetry panel interface is the same for all PTZ devices.

Create and configure the Telemetry control panel as follows:

1. Go to the **Interfaces** tab in the **System settings** dialog box (1).
2. Create the **Telemetry control panel** object under the **Display** object or select the relevant object in the **Interfaces** tab of the **System settings** dialog box (2).

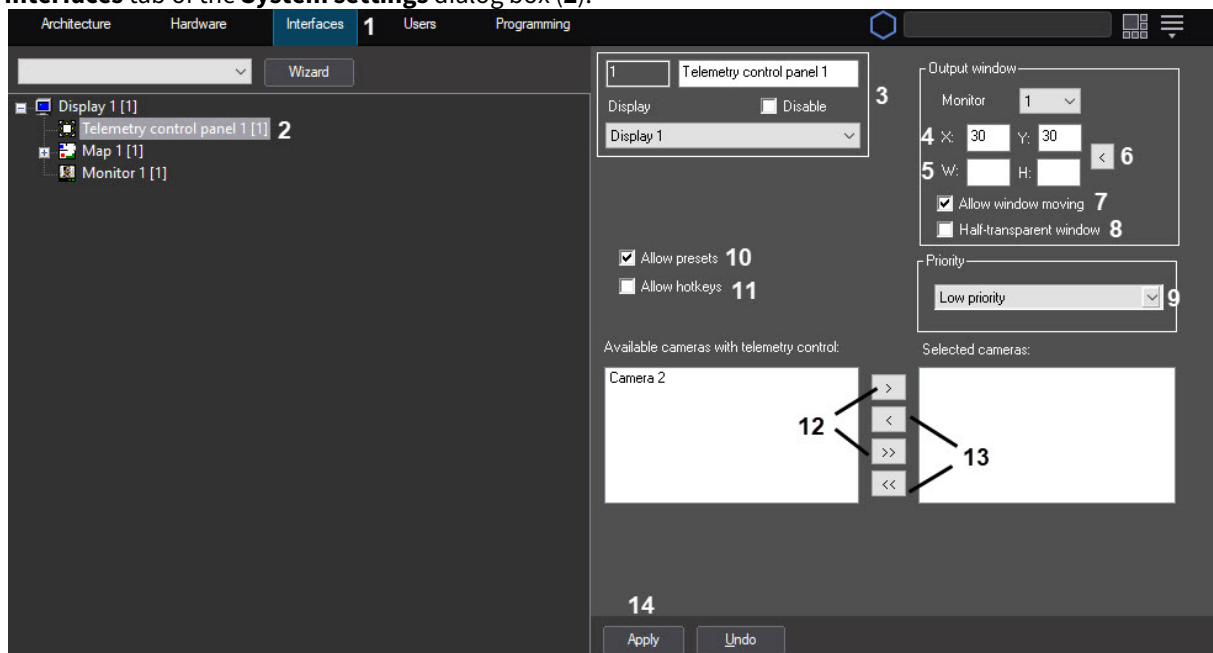

3. Specify the ID, the name of the **Telemetry control panel** object and select the **Display** object under which the **Telemetry control panel** object is created (3).
4. Change the **X** and **Y** coordinates of the telemetry panel position on the screen in the relevant fields. The **X** and **Y** values correspond to the screen coordinates of the top left corner of the telemetry control panel, and are shown as percentage of the horizontal and vertical screen sizes correspondingly (4).
5. Specify the dimensions of the **Telemetry control panel** interface object: the **W** (window width) and **H** (window height). Dimensions are shown as percentage of the horizontal and vertical screen sizes correspondingly (5).

Note

The < button (6) is used for automatic input of the current object coordinates specified by the user when using the **Telemetry control panel**.

6. By default, the telemetry control panel can be dragged over the screen. To fix the telemetry control panel position, set the **Allow window moving** checkbox unchecked (7).
7. By default, the telemetry panel is opaque. To display interface objects on the same screen with the telemetry control panel, set the **Half-transparent** checkbox (8).
8. If it is necessary to change the PTZ control priority via the **Telemetry control panel**, select the relevant item in the **Priority** list (9).

9. By default, the Operator is allowed to save the presets of PTZ device (presets of the camera position). To save presets, use the digital buttons on the **Presets** panel. To forbid the Operator to save the presets, set the **Allow presets** checkbox unchecked (10).
10. Set the **Allow hotkeys** checkbox checked if it is necessary to control PTZ device via the keyboard (11).
11. Move the names of the cameras equipped with PTZ devices to the **Selected cameras** list. These cameras will be controlled by the **Telemetry control panel** object. You can move the selected cameras in turn, if you click the one-arrow button or move all cameras if you click the two-arrow button (12).
12. Move the camera names from the **Selected cameras** list to the **Available cameras with telemetry control** list. These cameras will not be controlled by the **Telemetry control panel** object. To move the selected cameras in turn, click the one-arrow button; to move all cameras, click the two-arrow button (13).
13. To save the changes, click the **Apply** button (14).

✔ **PTZ control with Universal PTZ control panel**

3.4.7 Creating and configuring the Operator query panel for telemetry control

Axxon PSIM™ provides the PTZ control option using the **Operator query panel** interface object. The **Operator query panel** interface object is an individual user dialog box with the relevant elements to control a certain type of PTZ device.

The unique control panel is designed by the PTZ device vendor and is bundled with the PTZ software. The files of the unique PTZ control panels are stored in the **Program** folder of the Axxon PSIM™ installation directory.

Create and configure the **Operator query panel** as follows:

1. Open the **Programming** tab in the **System settings** dialog box (1).
2. Create a **Macro** object under the **Macros** object in the **Programming** tab (2). Specify the object's ID and name.

Note
The **Macro** object is necessary to refer to Axxon PSIM™ core and to display the **Operator query panel** on the screen.

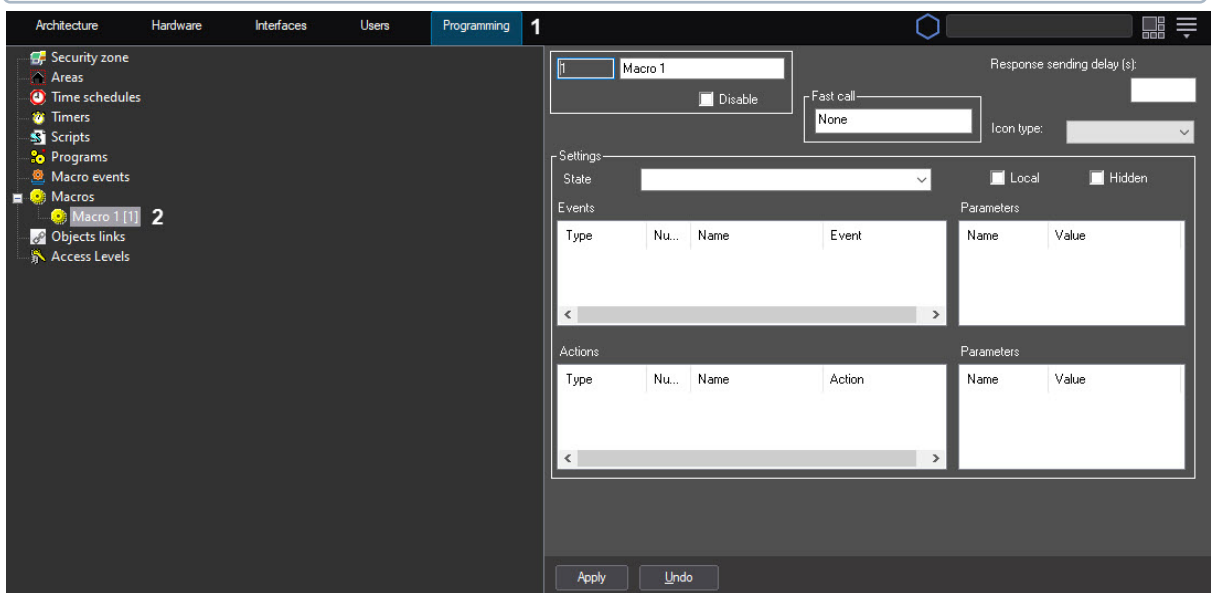

3. Open the **Hardware** tab in the **System settings** dialog box (3).

4. Create the **Operator query panel** object under the **Computer** object in the **Hardware** tab (4).

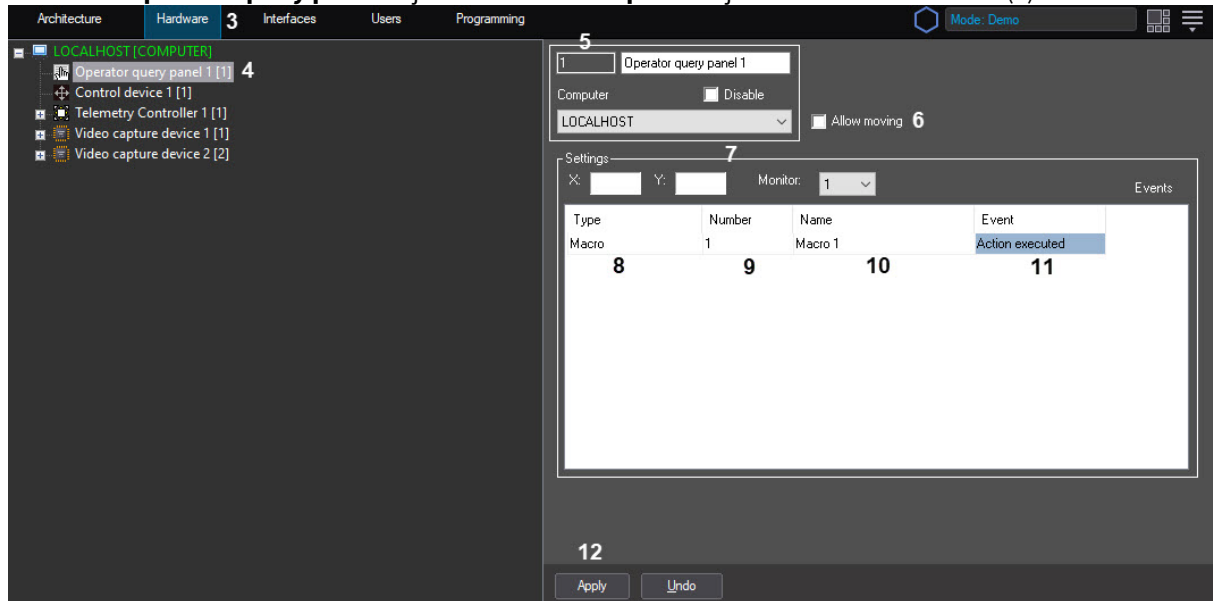

5. Specify the file name (without extension) of the dialog box, used for PTZ device control, in the ID field (5). The file should be created with the ArpEdit utility and saved in the **program** folder of the **Axxon PSIM™** installation directory (see [Creating a dialog box form](#)). You can also request dialog box file examples by contacting AxxonSoft technical support.
6. To activate the moving option for the **Operator query panel** object, set the **Allow moving** checkbox checked (6).
7. Specify the **X** and **Y** coordinates of the **Operator query panel** position on the screen in the relevant fields. The **X** and **Y** settings correspond to the screen coordinates of the top left corner of the **Operator query panel** and are shown as percentage of the horizontal and vertical screen sizes correspondingly (7).
8. Select the type of the **Macro** objects in the list of objects and events (8).
9. Specify the ID of the **Macro** object, created to call up the **Operator query panel** (9).
10. The name of selected **Macro** object is automatically displayed in the **Name** column (10).
11. Select the **Action executed** item in the list of possible events (11).
12. To save the changes, click the **Apply** button (12).

3.4.8 Configuring the Monitor for telemetry control

Axxon PSIM™ provides the PTZ control option using the Monitor windows that correspond to the cameras equipped with PTZ devices. In this case the PTZ device is controlled by the mouse using the viewing tiles of PTZ cameras.

PTZ control function via the viewing tiles corresponding to the cameras equipped with PTZ devices, is always enabled and can't be disabled. To access PTZ control via the viewing tile, do the following:

1. On conditions that the equipment is functional, configure the **PTZ device** object related to the selected PTZ device.
2. Select the PTZ control priority for the viewing tile in the settings of the **Monitor** object.

Additional configuration of telemetry control option is not required.

3.4.9 Configuring the joystick for telemetry control

Configuring the joystick to control PTZ devices may be performed in one of the following ways:

1. Using the **Control device** object (by default).

2. [Using Windows OS tools](#) (if the registry key DisableInternalJoystick = 0, see [Registry keys reference guide](#)).

Configuring joystick using Windows OS tools

Joystick setting procedure

Important!

Before configuring the joystick using the Windows OS tools, set the registry key DisableInternalJoystick = 0, see [Registry keys reference guide](#).

If the joystick is connected to the Server and configured in Windows OS, then *Axxon PSIM™* automatically activates the joystick telemetry control option. The option is valid for all PTZ devices connected to the Server and configured in *Axxon PSIM™*.

Generally, the joystick configuration contains the following stages:

1. Testing joystick handle functioning in *Axxon PSIM™*. This procedure is described in the [Testing joystick functioning](#) section.
Configuration of issuing the command to PTZ devices using the joystick keys. For configuration instructions, see the [Assigning commands to joystick buttons for telemetry control](#) section.
Testing joystick keys functioning in *Axxon PSIM™*. The procedure is similar to testing joystick handle functioning. For a detailed description, see the [Testing joystick functioning](#) section.

The following functions are available by default and do not require additional configuration:

1. Rotation of cameras equipped with PTZ devices is performed by inclining the joystick handle;

Note

Joystick threshold corresponds to the **Joystick Threshold** string parameter and is set in the HKLM\SOFTWARE\AxxonSoft\Axxon PSIM\Telemetry register of the Windows OS. By default, Joystick Threshold=1, this parameter can possess values from 0 and more. The bigger the value, the less sensitive the joystick is, the best value is selected empirically.

2. Zooming option is performed by turning a joystick handle around its vertical axis.

The zooming option is available only for joysticks with Z axis, for example Axis 295. This axis is formed by joystick handle's angles of rotation.

Z axis is enabled by default and corresponds to the value of **Zenable=1** string parameter in the HKLM\SOFTWARE\AxxonSoft\Axxon PSIM\Telemetry register of the Windows OS.

Attention!

The coordinate of joystick Z axis is to be automatically zeroized after every zooming for proper telemetry control. Otherwise, Z axis is to be disabled by setting the Zenable=0 parameter in the HKLM\SOFTWARE\AxxonSoft\Axxon PSIM\Telemetry section.

Note

Z axis is to be disabled when the Logitech USB joystick is used.

Assigning commands to joystick buttons for telemetry control

Certain commands can be assigned to the joystick buttons in order to issue default commands to PTZ devices.

This feature is available for USB joysticks only and not related to telemetry control panels.

To assign the commands to joystick buttons, do one of the following:

1. Edit the Windows OS registry (see [Assigning commands to joystick buttons using Registry Editor](#)).
2. Set up the Monitor (see [Assigning commands to joystick buttons using the Monitor](#)).

Note.

Some PTZ devices do not react to commands issued by the joystick buttons used for video camera rotation. In this case, you can rotate a video camera using a joystick handle.

Assigning commands to joystick buttons using Registry Editor

Here is a short list of actions that are to be performed in order to configure the joystick buttons. Detailed information on how to use the Windows OS registry can be found in the [Appendix 2. Relevant information on using Windows operating system](#) section of [Administrator's Guide](#).

Assign commands to the joystick buttons in the Windows OS registry as follows:

1. Open the **TELEMETRY** folder of the **HKEY_LOCAL_MACHINE -> SOFTWARE -> AxxonSoft -> Axxon PSIM** registry branch (**HKEY_LOCAL_MACHINE -> SOFTWARE -> Wow6432Node -> AxxonSoft -> Axxon PSIM** for 64-bit system).
2. Add a string parameter to the **TELEMETRY** folder.
3. Assign the name to the string parameter, identical to the number of the joystick button in the Windows OS.

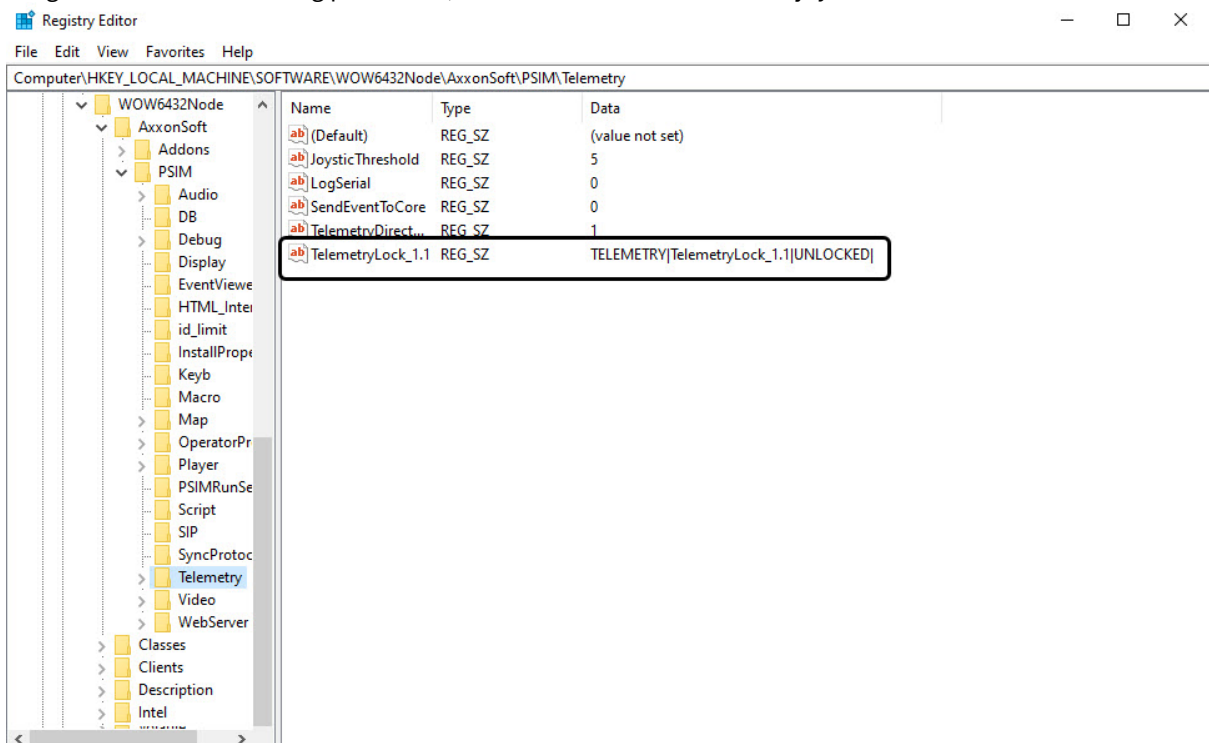

Note.

To define the numbers of the joystick buttons in the Windows OS, use the **Game devices** application.

4. Assign the value to the string parameter, identical to the name of the command executed by the PTZ device in Axxon PSIM™ (the value is to be entered in uppercase). Available commands in Axxon PSIM™ are listed in the table below:

Symbol	Command
AUTOFOCUS_ON	Activate the autofocusing option.
AUTOPAN_END_P	Set the autopan endpoint.
AUTOPAN_START	Start the autopan.
AUTOPAN_START_P	Set the autopan start point.
AUTOPAN_STOP	Stop the autopan.
CLEAR_PRESET	Clear the selected preset.
D2OFF	Disable additional dynamic settings for Panasonic PTZ cameras for improving an analog video signal.
D2ON	Enable additional dynamic settings for Panasonic PTZ cameras for improving an analog video signal.
DOWN	Rotate the camera lens down.
FOCUS_IN	Focusing the image in.
FOCUS_OUT	Focusing the image out.
FOCUS_STOP	Stop focusing the image in/out.
GO_PRESET.N	Rotate the video camera to the position set in N preset.
HOME	Rotate the video camera to the initial (home) position.
IRIS_CLOSE	Close the iris diaphragm.
IRIS_OPEN	Open the iris diaphragm.
IRIS_STOP	Stop the iris diaphragm.

Symbol	Command
LEFT	Rotate the camera lens left.
LEFT_DOWN	Rotate the camera lens left and down.
LEFT_UP	Rotate the camera lens left and up.
PATROL_LEARN	Start the programming procedure of patrolling by learning the video camera behavior.
PATROL_PLAY	Start patrolling.
PATROL_STOP	Stop patrolling.
RIGHT	Rotate the camera lens right.
RIGHT_DOWN	Rotate the camera lens right and down.
RIGHT_UP	Rotate the camera lens right and up.
SET_PRESET	Save the current position of the video camera in the selected preset.
STOP	Stop the camera lens rotation.
UP	Rotate the camera lens up.

Repeat steps 2-4 for each joystick button to which the command is to be assigned.

Joystick buttons are now configured.

Assigning commands to joystick buttons using the Monitor

The default commands assigned to joystick buttons are presented in the table below:

Button	Default command
1	Optical zoom in
2	Optical zoom out
3	Focus +

4	Focus -
5	Enable auto focus
6	Not specified
7	Open diaphragm
8	Close diaphragm
9	Not specified
10	Not specified

Assign commands to joystick buttons using the Monitor as follows:

1. Go to the **Interfaces** tab (1).

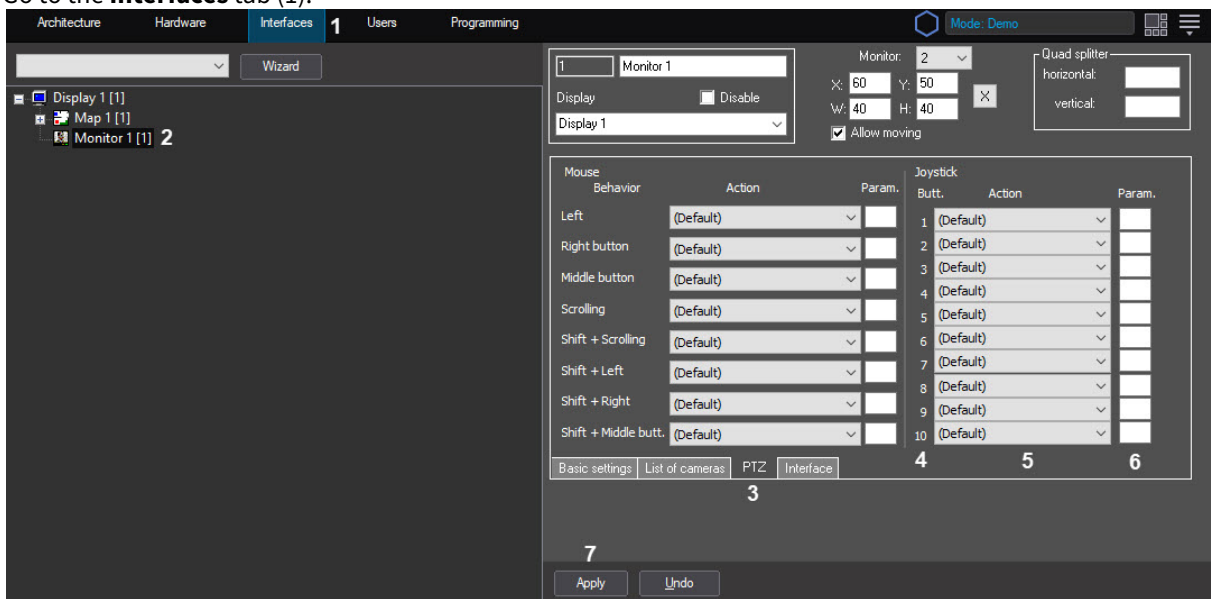

2. Go to settings panel of the **Monitor** object which is in use to display video from the camera to which the PTZ device is assigned (2).
3. Go to the **PTZ** tab (3).
4. Joystick buttons are listed in the **Joystick buttons** column (4). Buttons numeration depends on the joystick model and is described in the reference documentation.
5. In the **Action** dropdown list, select a reaction of the **PTZ device** object next to the required button. This reaction will be performed when clicking the button (5).
6. In case of the selected reaction requires specifying the parameter, e.g. preset number or speed, specify the value of this parameter in the **Parameter** field (6).
7. To save changes, click the **Apply** button (7).

Note.

Settings of the Monitor from which controlling is performed are in use if different actions are assigned to one button in several Monitors.

Joystick buttons are now configured.

Testing joystick functioning

Before configuring and using a joystick to control PTZ devices, test its functioning in *Axxon PSIM™*.

To test the joystick functioning in *Axxon PSIM™*, do the following:

1. Make sure that PTZ devices are connected, configured and operate properly in *Axxon PSIM™*.
2. Display the video surveillance monitor on the screen.
3. Check if cameras equipped with PTZ devices are displayed on the video surveillance monitor. If not, change the layout of viewing tiles.
4. Activate the selected viewing tile by left clicking it.
5. Display the telemetry module debug window. To display the telemetry module debug window, double click with the left button upon the window icon in the notification zone of the Windows OS menu.



6. As a result, the telemetry module debug window is displayed.

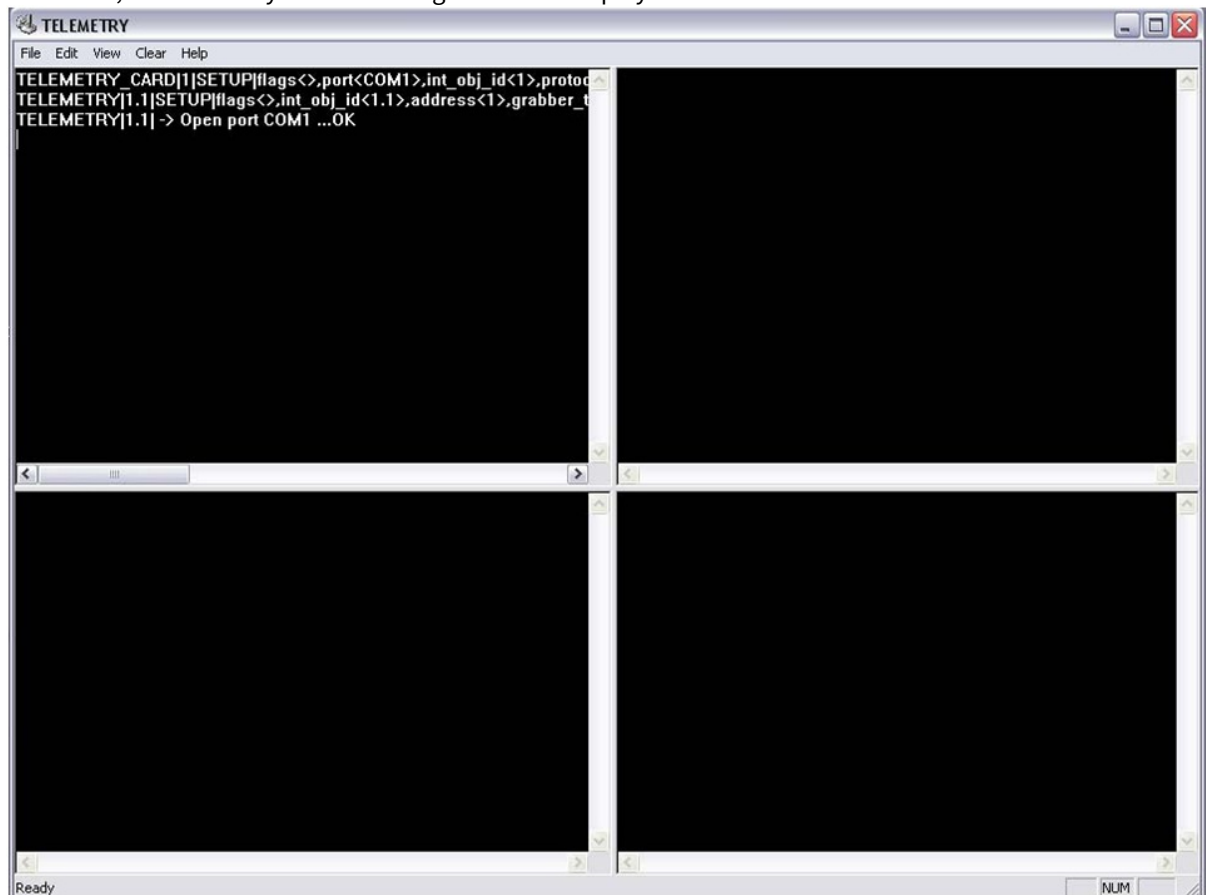

7. To test the joystick handle functioning, rotate it in different directions.
8. To test the joystick buttons functioning, push them in turn.
9. If the joystick operates properly, the relevant commands are displayed in the debug window.

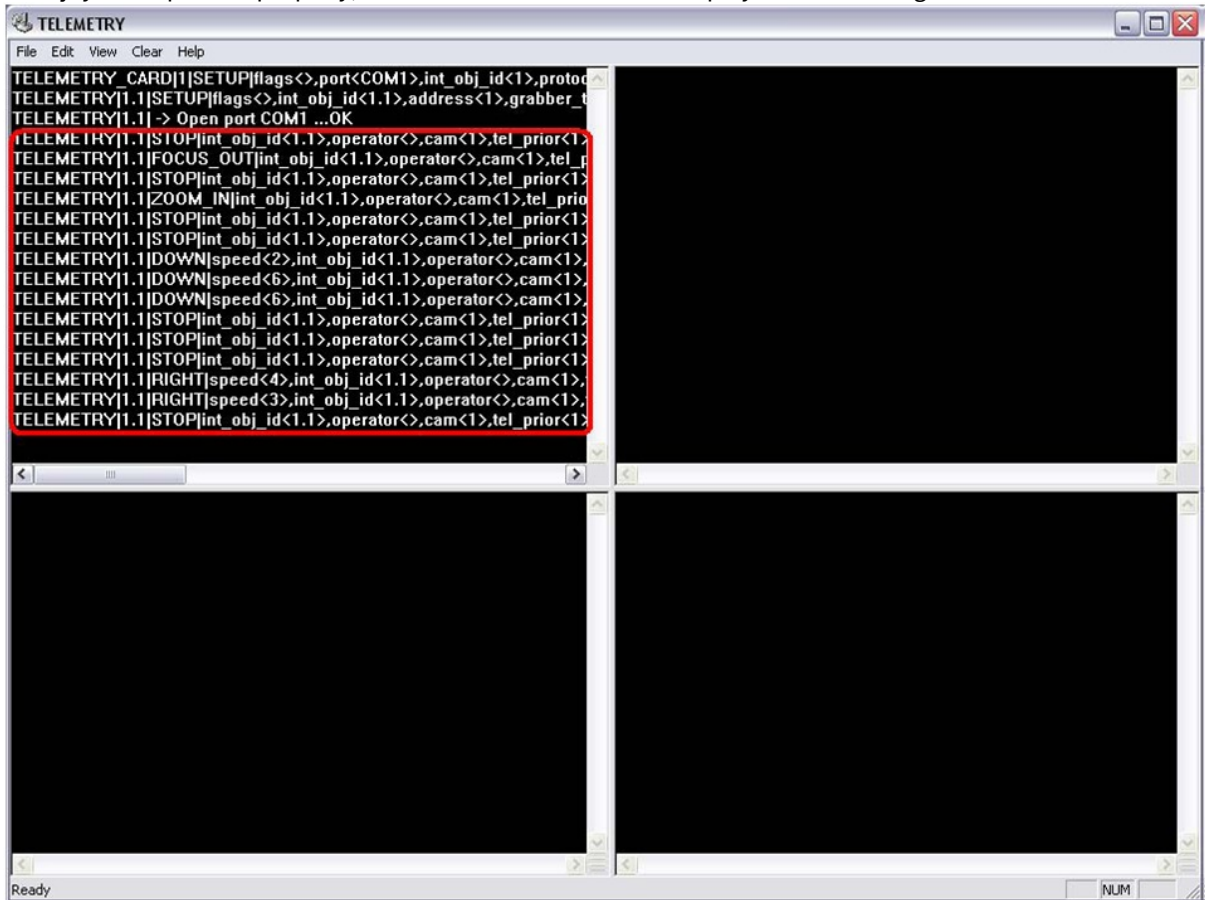

10. If there are no commands in the debug windows, then the joystick does not operate in *Axxon PSIM™*. Check its connection to the computer and its data exchange driver settings in the Windows OS.

The joystick functioning is now tested.

Configuring the Control Device object

The **Control Device** object is for configuring joysticks integrated in Drivers Pack (see [Drivers Pack documentation](#)).

Important!

Create and configure the **Control Device** object under each **Computer** in order to use the same joystick to control PTZ devices on the Video surveillance monitors of corresponding computers.

For example, you should create the **Control Device** object under both the Server and the Workstation to control the PTZ camera on both the Server and the Workstation using the same joystick.

Configure the **Control Device** object as follows:

1. Create the **Control device** object under the **Computer** object on the **Hardware** tab of the **System settings** dialog box (1).

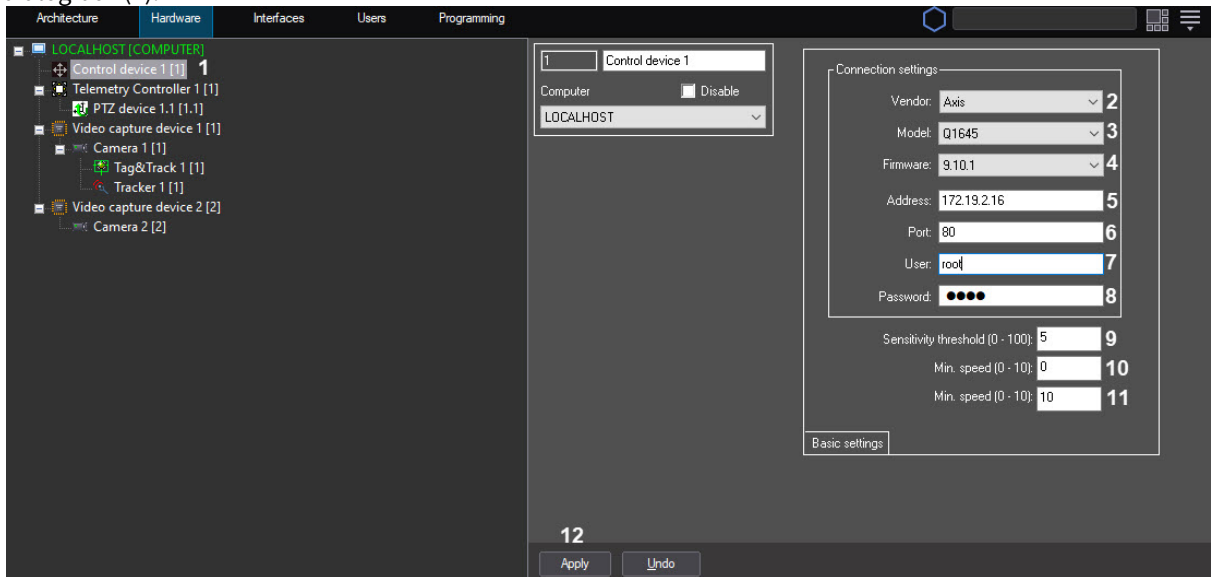

2. Select the device manufacturer from the **Vendor** drop-down list (2).
3. Select the device model from the **Model** drop-down list (3).
4. Select the firmware number from the **Firmware** drop-down list (4).
5. Enter the device IP-address in the **Address** field (5).
6. Enter the device connection port in the **Port** field (6).
7. Enter the user name to connect to the device in the **User** field (7).
8. Enter the password to connect to the device in the **Password** field (8).
9. Set the joystick sensitivity threshold in the **Sensitivity threshold** field (9). The threshold is measured in logical elementary shift units in the range from 0 to 100 and means the maximum shift along any of the axes at which the joystick movement messages do not arrive in Axxon PSIM.
10. Set the minimal joystick speed in logical elementary shift units in the **Min. speed** field (10).
11. Set the maximal joystick speed in logical elementary shift units in the **Max. speed** field (11).
12. Click **Apply** (12).

The **Control device** object configuration is now complete.

Features of Dahua DH-NKB1000 PTZ control device configuration

On the page:

- [Control device modes of operation](#)
- [Features of setting in the OS](#)
- [Configuring the Dahua DH-NKB1000](#)

control device
in Axxon PSIM

Control device modes of operation

For correct operation in *Axxon PSIM*, the control device must be defined in Windows as a KEYBOARD 1000 game device. This can be checked in the **Devices and Printers** panel accessible from the **Start** menu.

If the device is identified as a HID keyboard, you need to switch the mode by long pressing the Shift key on the control device itself.

Features of setting in the OS

For correct operation, the console must be defined in Device Manager as an HID-compliant game controller. If the console is defined as BETTER_USB_HS in Windows Device Manager, roll back the device driver (this can be done in the driver **Properties** window).

Configuring the Dahua DH-NKB1000 control device in Axxon PSIM

The Dahua DH-NKB1000 control device can be added via [Camera discovery tool](#).

If necessary, the connection of the Dahua DH-NKB1000 control device to the *Axxon PSIM* software package can be configured manually as follows:

1. Create the **Control device** object under the **Computer** object on the **Hardware** tab of the **System settings** dialog window.

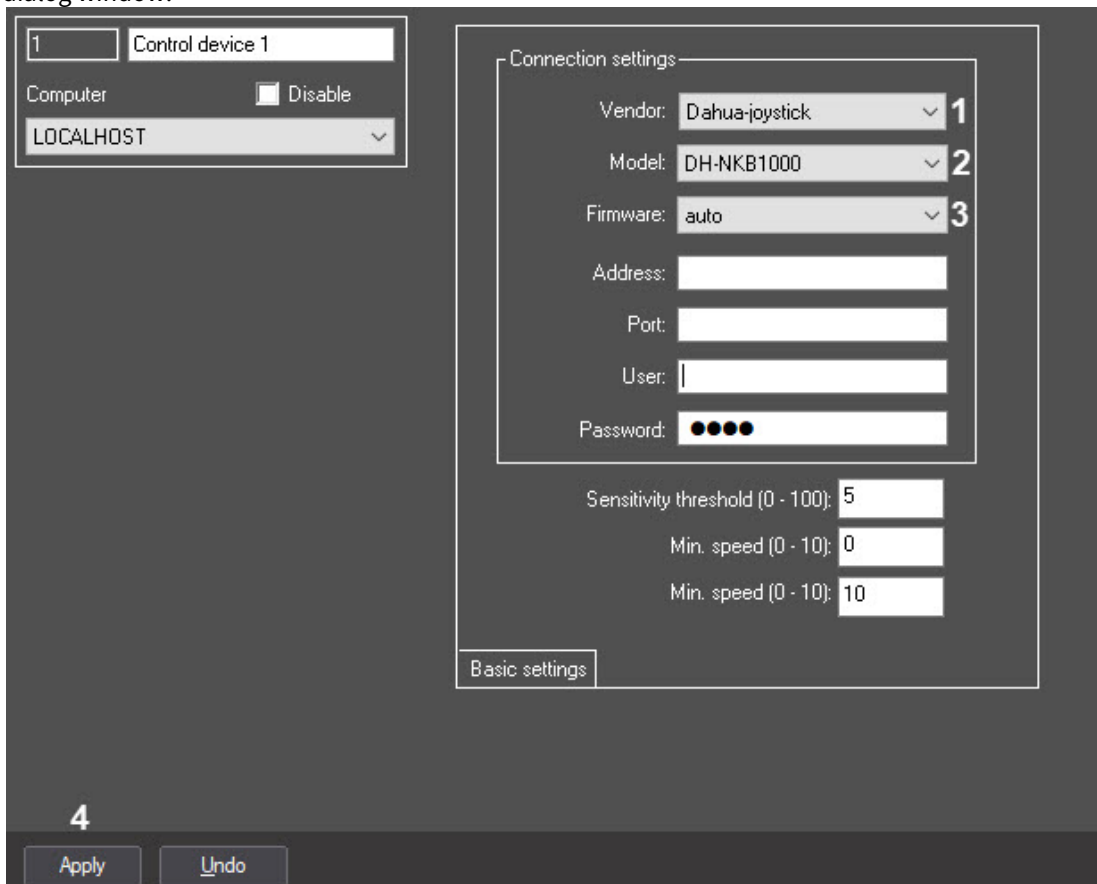

2. Select **Dahua-joystick** from the **Vendor** dropdown list (1).

3. Select **DH-NKB1000** from the **Model** drop-down list (2).
4. Select **auto** from the **Firmware** drop-down list (3).
5. Click the **Apply** button (4).

Configuring the connection of the Dahua DH-NKB1000 control panel to the *Axxon PSIM* software package is now complete.

Features of Hikvision DS-1200KI PTZ control device configuration

On the page:

- [Configuring the Hikvision DS-1200KI control device before adding it to Axxon PSIM](#)
- [Configuring the Hikvision DS-1200KI control device in Axxon PSIM](#)
- [Features of the Hikvision DS-1200KI control device operation in Axxon PSIM](#)

Configuring the Hikvision DS-1200KI control device before adding it to Axxon PSIM

Configure the Hikvision DS-1200KI PTZ control device as follows before creating the corresponding object in *Axxon PSIM*:

1. Set the control device address: **Select System - Network** in the device internal menu, then disable DHCP and set IP address and gateway.

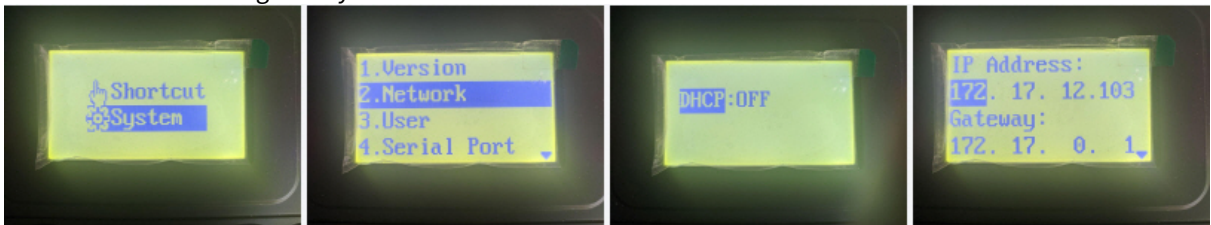

2. Set the *Axxon PSIM* server IP address and port on the device: Open the device web interface by entering the above set IP address in the web browser, then select **Platform Access - Third-Party Platform**.

Note.

The web interface is only available on https by default, so please use https prefix before the IP address.

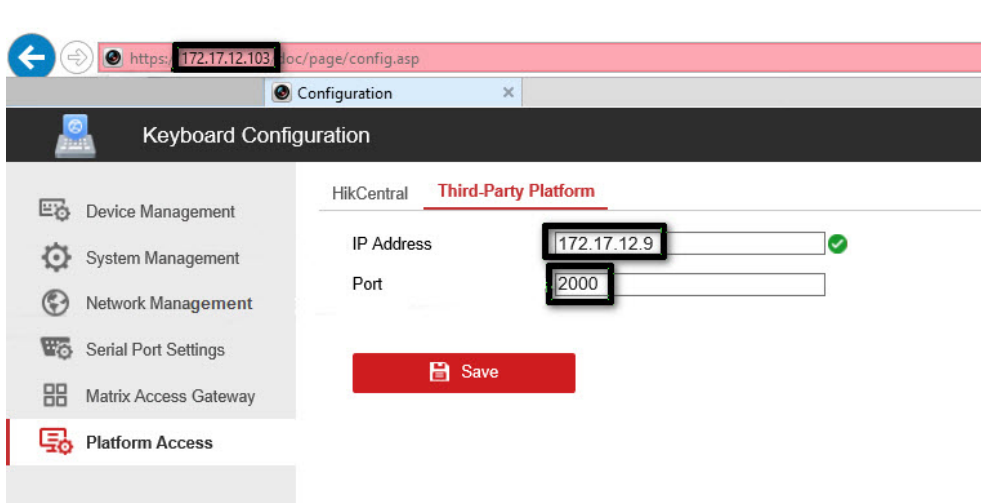

3. Set the **8. Private VMS** mode in the device's internal interface.

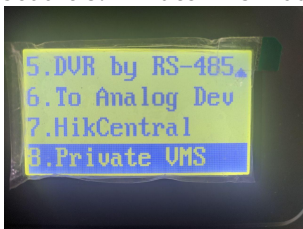

4. Transfer the PTZ control device to operating mode by one of the following actions:
 - a. Select any monitor MON (monitor) [integer in the range 1-9999], any camera CAM (camera) [integer in the range 0-999999]; in this mode all keys will work, including the WIN (subwindow of video wall) and MULT (layout size) keys for the monitor and camera.
 - b. Select any camera CAM (camera) [integer number in the range 1-999999 (number 0 is available only when setting the monitor)]; the WIN, MULT and CAM-G keys will not work in this mode.
 - c. Select any monitor MON (monitor) [integer in the range 1-9999] and any group of cameras CAM-G (camera group) [integer in the range 1-999999]; in this mode, only the MULT, OK keys and the rotations of the joystick axes will work.

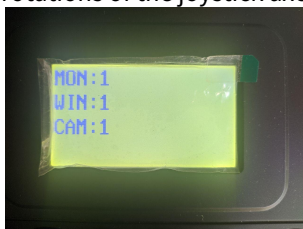

Note.

To select these parameters, enter a number on the device keypad, then press the corresponding key (MON / WIN / CAM / CAM-G).
 If the server IP address and/or port is not accessible from the PTZ control device, the "Connect failed" message will be displayed on the control device screen after pressing the MON / WIN / CAM / CAM-G keys.

The Hikvision DS-1200KI PTZ control device is now preconfigured.

Configuring the Hikvision DS-1200KI control device in Axxon PSIM

Note.

Make sure that `DisableInternalJoystick` registry key has its default value of 1 (see [Registry keys reference guide](#)) before proceeding with control device configuration in *Axxon PSIM*.

To configure the connection of the Hikvision DS-1200KI control device to the *Axxon PSIM* software package, proceed as follows:

1. Create the **Control device** object under the **Computer** object on the **Hardware** tab of the **System settings** dialog window (1).

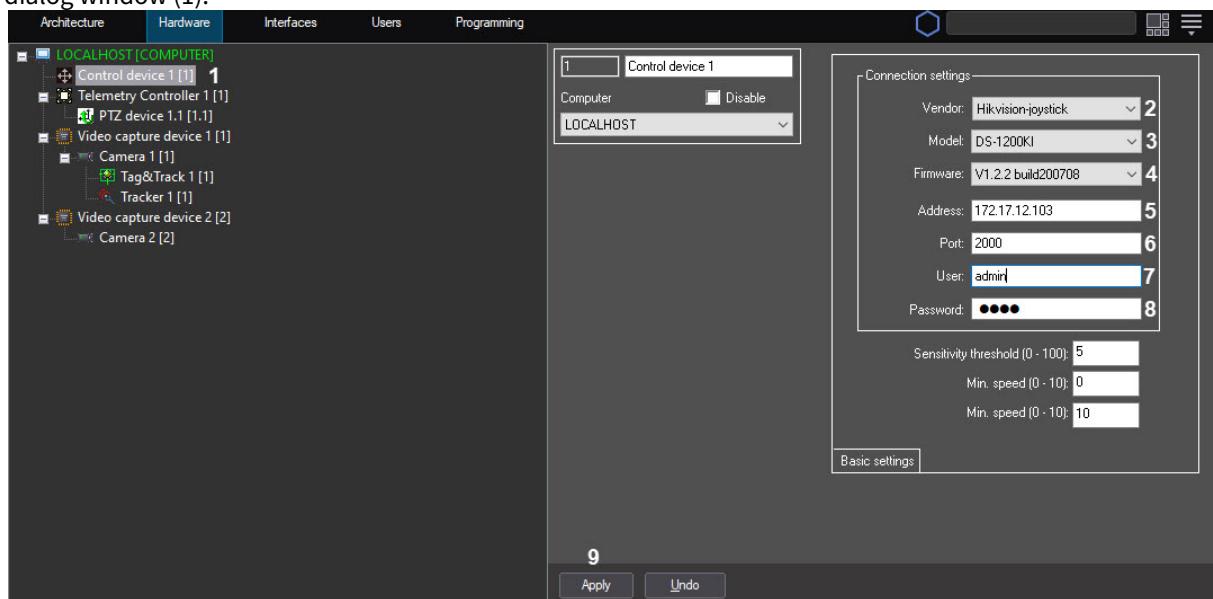

2. Select **Hikvision-joystick** from the **Vendor** dropdown list (2).
3. Select **DS-1200KI** from the **Model** drop-down list (3).
4. Select **V1.2.2 build20051** from the **Firmware** drop-down list (4).
5. In the **Address** field, enter the IP address of the control device (5).
6. In the **Port** field, enter the port of the control device (6).
7. In the **User** field, enter the username to access the device (7).
8. In the **Password** field, enter the password to access the device (8).
9. Click the **Apply** button (9).

Configuring the connection of the Hikvision DS-1200KI control panel to the *Axxon PSIM* software package is now complete.

Features of the Hikvision DS-1200KI control device operation in *Axxon PSIM*

When the MULT, PRESET, PATROL, or PATTERN keys are pressed on the device, the following actions are performed:

- when entering a number in the range 1-99 and pressing MULT for each number, *Axxon PSIM* receives a message about pressing the corresponding separate key with a number in the range 23-121 (B22-B120);
- when pressing PresetRec for the first time, *Axxon PSIM* receives a message about pressing key 13 (B12), and the device displays **Record started**;
- after pressing PresetRec for the second time, *Axxon PSIM* receives a message about pressing key 12 (B11), and **Record ended** appears on the device display;
- when entering a number in the range 1-65535 and pressing PresetRec, *Axxon PSIM* receives a message about pressing key 22 (B21), and the device displays **PRESET;**

- when entering a number in the range 1-65535 and pressing Patrol, *Axxon PSIM* receives a message about pressing key 17 (B16), and the device displays **PATROL;**
- when entering a number in the range 1-65535 and pressing PatternPlay, *Axxon PSIM* receives a message about pressing key 18 (B17), and the device displays **PATTERN;**
- when entering a number in the range 65536-999999 and press any of the PresetRec / Patrol / PatternPlay buttons, nothing happens: such numbers are not processed.

Features of UNIVIEW KB-1100 PTZ control device configuration

On the page:

- General description of the UNIVIEW KB-1100 PTZ control device
- Configuring the PTZ control device before adding it to *Axxon PSIM*
- Configuring the remote control in *Axxon PSIM*

General description of the UNIVIEW KB-1100 PTZ control device

A schematic representation of the UNIVIEW KB-1100 PTZ control device is shown in the figure below.

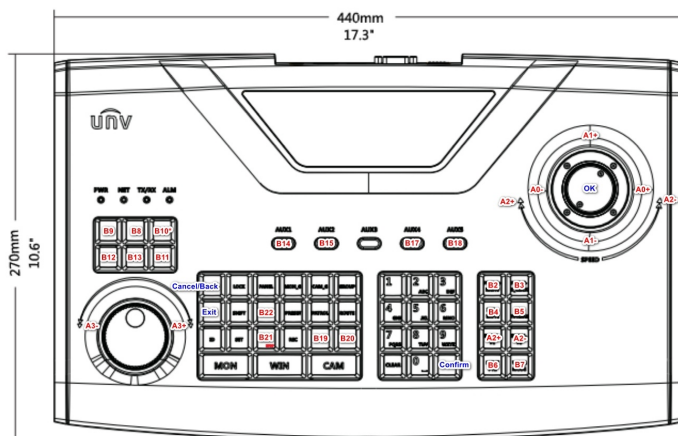

The following physical controls are available on the device:

Joystick is a rotary control moving along three axes:

- Pan axis (panning: left or right deviation).
- Tilt axis (tilt: up or down deviation).

- Zoom axis (scaling: clockwise or counterclockwise deviation).

Acceleration along each of the three axes depends on the degree of deviation from the center. The movement is carried out until release. When released, the control returns to its original position.

Jog-Wheel (not integrated into the *Axxon PSIM* software package!) is a rotary control rotating only around its axis. When released, the control returns to its original position. In the illustration it is located at the bottom left (outer ring).

Shuttle is a rotary control rotating only around its axis. Allows the intermittent movement in one of two directions. It has no initial position; when released, it remains in place. In the illustration it is located at the bottom left (inner ring).

Button is a push control element that can represent two states. Allows the call of one of two functions (the function for pressing and the function for releasing). When released, it returns to its original position (“not pressed” state).

Of all the push-button controls of the remote control, the following blocks are integrated:

- a block of playback control keys (6 keys on the left: the record button is triggered after pressing a button on the joystick);
- block of keys for control of focus, zoom, aperture and PTZ presets (8 keys);

The following keys to manipulate the device interface are also available (not related to *Axxon PSIM*):

- Pressing the button on the remote control joystick (OK) (equivalent to pressing the ENTER key).
- Cancel the action / return one step back in the remote control menu (equivalent to pressing the ESC key).
- Numbers / letters are entered from the numeric keyboard, the mode (upper/lower register, digits) is switched by the SHIFT key.
- Moving through the menu items and within the fields is carried out by deviating the remote control vertically / horizontally.

Configuring the PTZ control device before adding it to *Axxon PSIM*

Before creating the corresponding object in *Axxon PSIM* software package, configure the UNIVIEW KB-1100 PTZ control device as follows:

1. Switch on the control device.
2. Enter username and password in the device display. The default credentials are as follows:
 - a. login: admin
 - b. password: 123456
3. Configure the device network configuration. To do this, in the Local Cfg -> Net Cfg menu, set the following settings:
 - a. IP address
 - b. Mask
 - c. Gateway
4. Add *Axxon PSIM* Server/Client to the internal configuration of the device. To do this, in the Dev Manage -> Manual Cfg -> Add Dev menu, set the following settings:
 - a. ID – enter any number (range: 1-240, the number must not coincide with the ID of the remote control or other already added device).
 - b. name – enter a string (1-8 characters).
 - c. DType – select VM (VideoManagementSystem, i.e. *Axxon PSIM*).
 - d. LType – select NetWork (the device is integrated for connecting to *Axxon PSIM* via the network).
 - e. After selecting LType, press the button on the joystick and enter the IP address of the *Axxon PSIM* Server/Client and the port used (60000 by default).
5. Connect to the *Axxon PSIM* Server/Client added in the previous step. To do this, enter the above ID in the FindDev -> Dev ID menu or select the found profile in the Dev Manage -> Search Dev menu.
6. If the device is found, information about it will be displayed on the device display.
7. Press on the ID field. As a result, it will be possible to work with the control device in *Axxon PSIM*.

Setting up the UNIVIEW KB-1100 control device is completed.

Configuring the remote control in Axxon PSIM

To configure the connection of the UNIVIEW KB-1100 PTZ control device to the *Axxon PSIM* software package, proceed as follows:

1. Create the **Control device** object under the **Computer** object on the **Hardware** tab of the **System settings** dialog window (1).

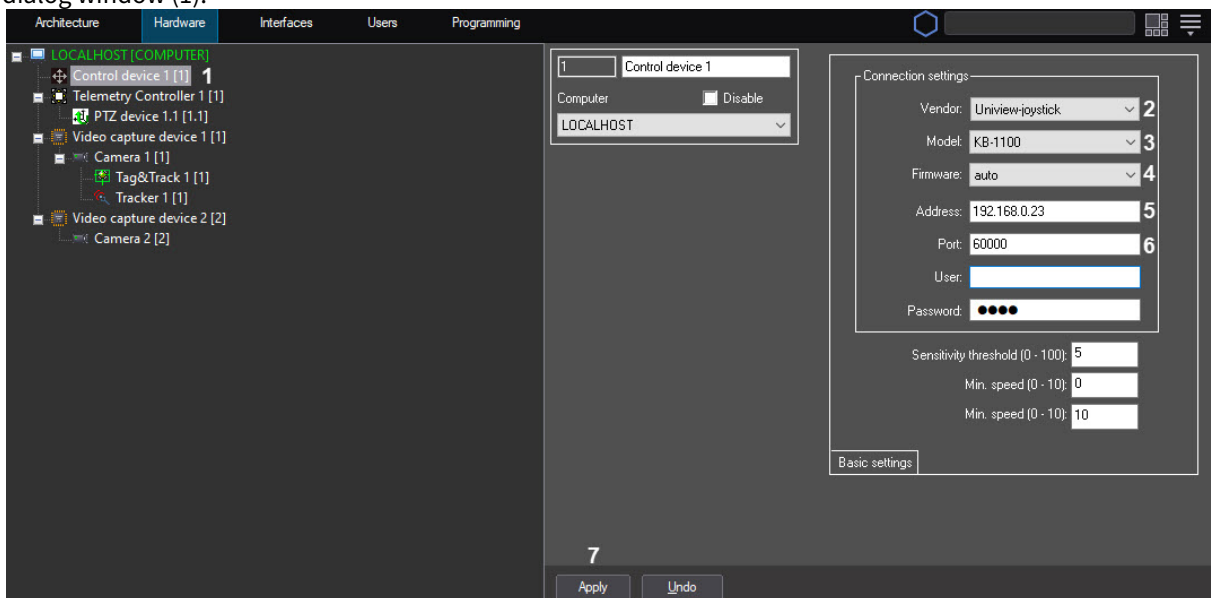

2. Select **Uniview-joystick** from the **Vendor** dropdown list (2).
3. Select **KB-1100** from the **Model** drop-down list (3).
4. Select **auto** from the **Firmware** drop-down list (4).
5. In the **Address** field, enter the IP address of the control device (5).
6. In the **Port** field, enter the port number specified in step 4e of the device configuration (6).
7. Click the **Apply** button (7).

Configuring the connection of the UNIVIEW KB-1100 PTZ control panel to the *Axxon PSIM* software package is now complete.

PTZ control with control panel

3.4.10 Configuring the mouse buttons to control PTZ devices

It is possible to change commands of telemetry control for mouse buttons in *Axxon PSIM*.

Default actions assigned to mouse buttons and to buttons combinations are presented in the table below.

Note.

New control features are used by default and their description is given in the **New default action** column. If the previous PTZ control features are to be used, then set 0 value for the TelemetryMouseAlternative registry key – see [Registry keys reference guide](#).

Button/button combination	Old default action	New default action
Left button	Optical zoom in	-
Right button	Optical zoom out	-
Middle button	Auto changing of video camera objective orientation to the area on which the mouse button click was performed (Point&Click)	
Scrolling	Digital zoom	Optical zoom
Shift+Scrolling	Digital zoom	
Shift+Left button	Focus In	
Shift+Right button	Focus Out	
Shift+Middle button	Auto changing of video camera objective orientation to the area on which the mouse button click was performed (Point&Click)	

Note.

See more info in [Mouse PTZ control](#) section.

Assign actions to mouse buttons as follows:

1. Go to the **Interfaces** tab of the **System settings** dialog box (1).

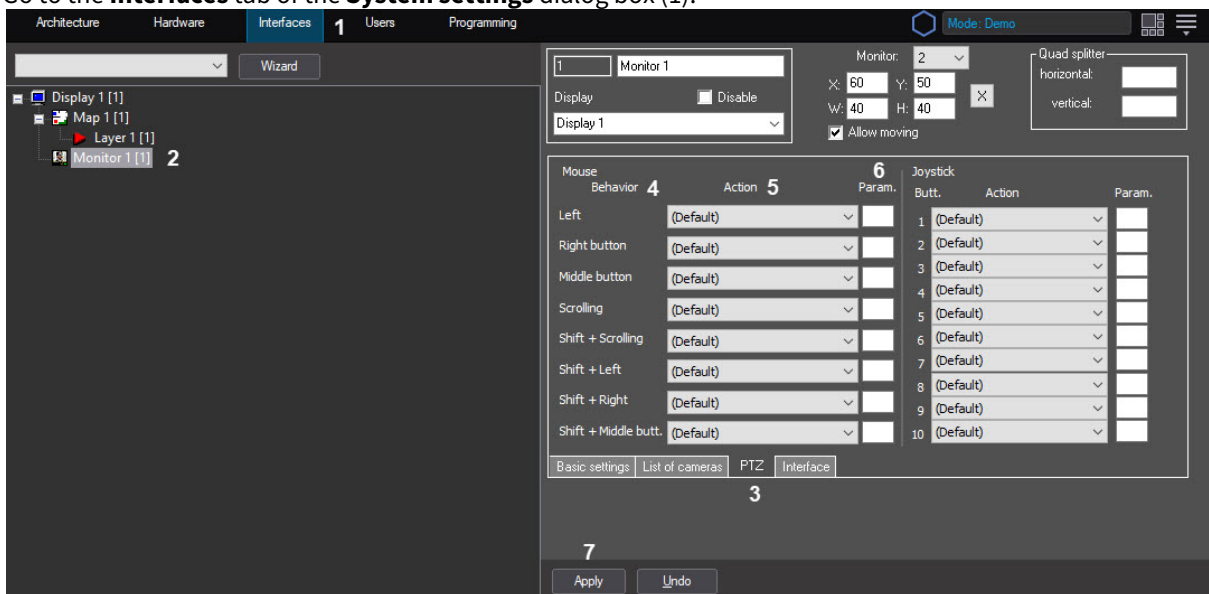

2. Go to settings panel of the **Monitor** object which in use to display video from the camera with which the PTZ device is connected (2).

3. Go to the **PTZ** tab (3).
4. Buttons and button combinations to which it is possible to assign telemetry commands are listed in the **Mouse behavior** column (4).
5. In the **Action** dropdown list, select the reaction of **PTZ device** object next to the required button. The reaction will be performed while clicking this button (5).
6. If the selected reaction requires specifying the parameter, e.g. preset number or speed, specify the value of this parameter in the **Parameter** field (6).
7. To save changes, click the **Apply** button (7).

Note.

Settings of the Monitor from which controlling is performed are in use if different actions are assigned to one button in several Monitors.

Mouse buttons are now configured.

3.4.11 Configuring functions for tracking moving objects

Tag & Track configuration

The Tag & Track function allows a PTZ camera to follow a moving object based on the trajectories obtained by a conventional stationary video camera using the **Tracker** object. Thus, first create and configure the following objects in *Axxon PSIM* to use the Tag & Track function:

1. The PTZ camera (see [Configuring PTZ IP cameras](#)).
2. The conventional (stationary) video camera with the Tracker object (see [Configuring IP devices](#) and [Creating and configuring the Tracker object](#)).

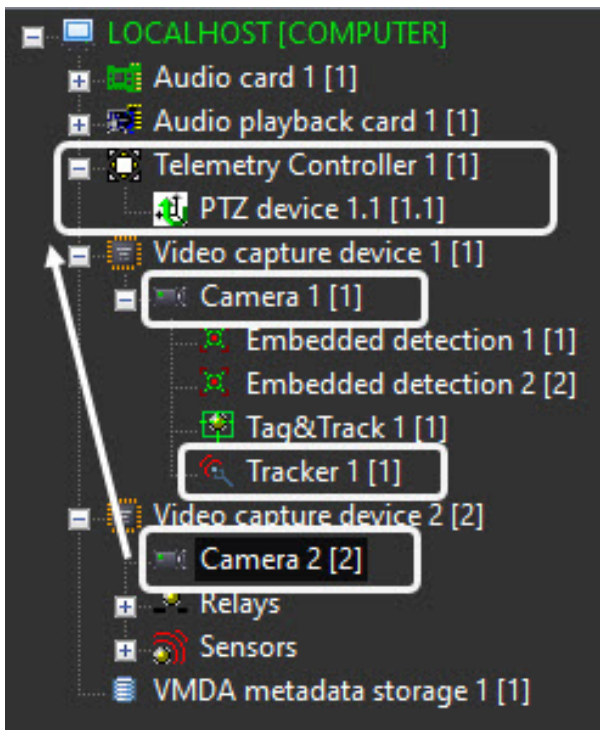

To configure the Tag & Track function, do the following:

1. Create the **Tag&Track** object on the basis of the **Camera** object (not the PTZ camera!).

Note
 If the camera is linked to a PTZ device, creating the **Tag&Track** object will not be available. If you first create this object, then link the camera to a PTZ device, then the settings for the **Tag&Track** object will not be available.

- From the **PTZ** drop-down list, select the **PTZ device** object linked to the corresponding PTZ camera that will be used for objects tracking (1).

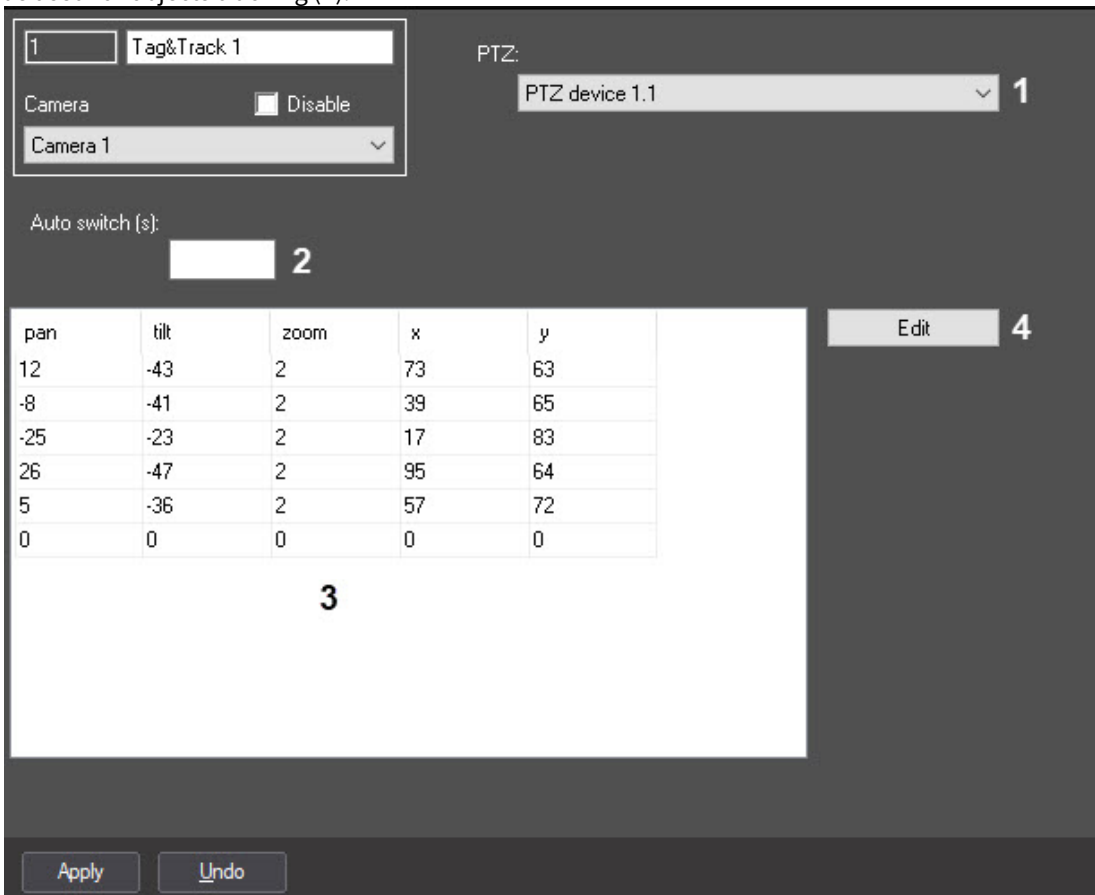

- In the **Auto switch** field (2), enter the time period in seconds after which you want to automatically switch to the next object in the **Automatic** Tag&Track mode.
- Select a line in the table (3). To do that, left-click on any cell in the line.

Note
 The lines can be sorted by one of the specified parameters. To do this, click on the name of the corresponding column.

- Click the **Edit** button (4). The **Settings** dialog box opens.
 If step 3 is skipped and no line is selected in the table, then the **Settings** dialog box will not open and the message "String not selected" will be displayed.

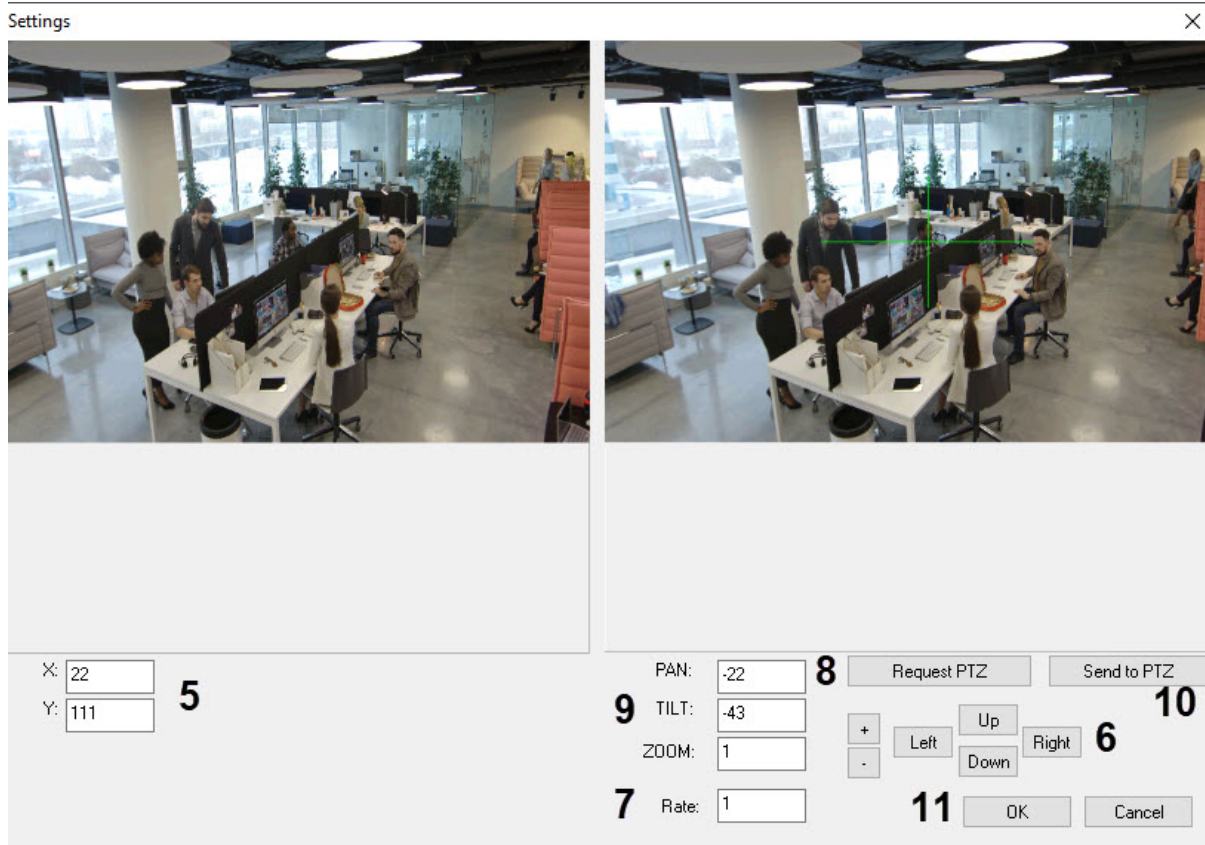

Note

- For calibration, a video image with a low resolution is used, so the display quality in the **Settings** window may differ from the original video image from the camera.
- It is possible to display the video in a separate window and expand this window to the required size. To do this, right-click on the video image while holding down the Shift key on the keyboard. The video in the separate window allows the same operations as in the **Settings** dialog box.

6. Click on a required point on the video image from the stationary camera (on the left). As a result, the **X** and **Y** fields are filled with this point coordinates (5). The point is highlighted with a red square on the video image.
7. Rotate the PTZ camera (on the right) so that the green cross in the center pointed at the same point as selected on the stationary camera. Use the **Up**, **Down**, **Left** and **Right** buttons to control camera movement, and the **+** and **-** buttons to zoom in and out (6).
8. In the **Rate** field (7), set the movement speed of the PTZ camera lens. Possible values are from 1 to 10, the default value is 1.
9. Click the **Request PTZ** button (8).
10. The **PAN**, **TILT**, **ZOOM** fields will be filled with the PTZ camera coordinates (9).
11. If the check is required, then click the **Send to PTZ** button (10). The camera will be positioned to the obtained coordinates.
12. Click the **OK** button (11). The coordinates are displayed on the **Tag&Track** object settings panel.
13. Repeat steps 4-11 at least 5 times for different points on the video image. It is recommended to add as much points as possible.
14. Click the **Apply** button.

Note

When too few points are set, or in some other cases when the points are not set properly, and the algorithm cannot process them, the "Invalid calibration" message is displayed after clicking the **Apply** button.

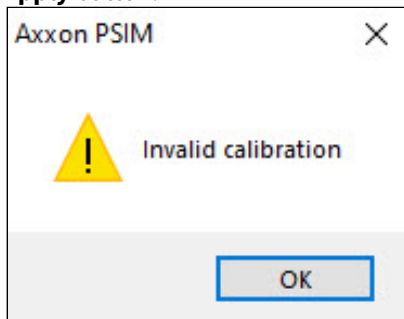

In this case, click the **OK** button then add or edit the points.

Attention!

The following recommendations will help to configure the function better:

1. The overview and the PTZ cameras should be close to each other. If they are far from each other, they can interpret the scene differently. Because of this, sometimes the algorithm may not operate correctly.
2. The points set in the calibration setting should not be on the same line for both the overview and the PTZ camera. It is recommended to set the points for both cameras so that they evenly cover the entire frame.
3. The recommended number of points that should be set is 4-10. If you add more points, the algorithm will be configured more precisely. However, this may increase the chance that some of the points are set up incorrectly, which may cause the decrease of the operation quality.

Configuring the Tag & Track function is completed.

✔ Using Tag&Track

Using absolute telemetry

General information about absolute telemetry in Axxon PSIM

It is possible to use PTZ cameras that support positioning by absolute coordinates to track objects on the map in *Axxon PSIM*. This feature can be in use if it is possible to get coordinates of the object on the map, for instance, when using *Strelec-Integral. Web extension* integration module that is the part of the subsystem *ACFA Axxon PSIM* subsystem (only available in Russian at the moment). This module enables getting coordinates of beacons and bracelets, and if these coordinates change, PTZ camera rotates. Coordinates can be assigned to any object on the map including using scripts (see [Examples of script commands for controlling absolute telemetry](#)).

Configure absolute telemetry as follows:

1. [Select the object tracking monitor.](#)
2. [Configure map binding to coordinate grid.](#)
3. [Set the camera FoV on the map.](#)
4. [Configure the calibration of points in the camera FoV.](#)

Selecting object tracking monitor

Object tracking monitor is a Video surveillance monitor that displays video from PTZ cameras used to track objects in absolute coordinates. You should create and configure the **Monitor** object corresponding to the object tracking monitor and add all required cameras to it (see [Configuring video display on Video Surveillance Monitor](#)).

When coordinates of the tracked object are changed, the camera, in the FoV of which it appeared, rotates to the point where it appeared, and the video from this camera is displayed on the object tracking monitor. When all the objects leave the PTZ camera FoV, it stops being displayed on the object tracking monitor. See [Setting camera FoV on map](#).

Select the object tracking monitor as follows:

1. Go to the settings panel of the **Map** object.

2. Select the corresponding **Monitor** object in the **Object tracking monitor** dropdown list (1).
3. Click the **Apply** button (2).

The object tracking monitor is now selected.

Configuring map binding to coordinate grid

Note.

If an external map is selected as a background, the layer is automatically binded to geographical coordinates – see also [Configuring the external Map server](#)

Set map binding to coordinate grid as follows:

1. Start the *Map editor* utility for the required map layer (for details, see [Configuring the interactive map for object state indication and controlling the objects](#) section in *Administrator's Guide*).
2. Display the **Properties** panel to edit the object properties on the map (see [Editing object properties using the Properties panel](#)).
3. Select **Add geotagging** in the **Map** menu.

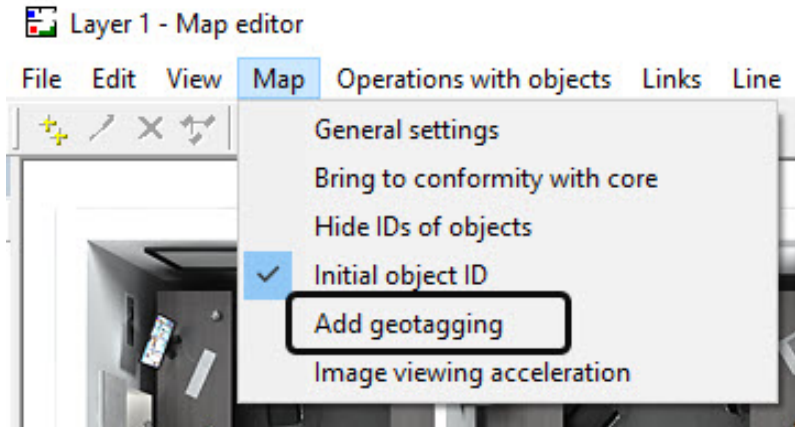

4. The axes will be arranged on the map (1).

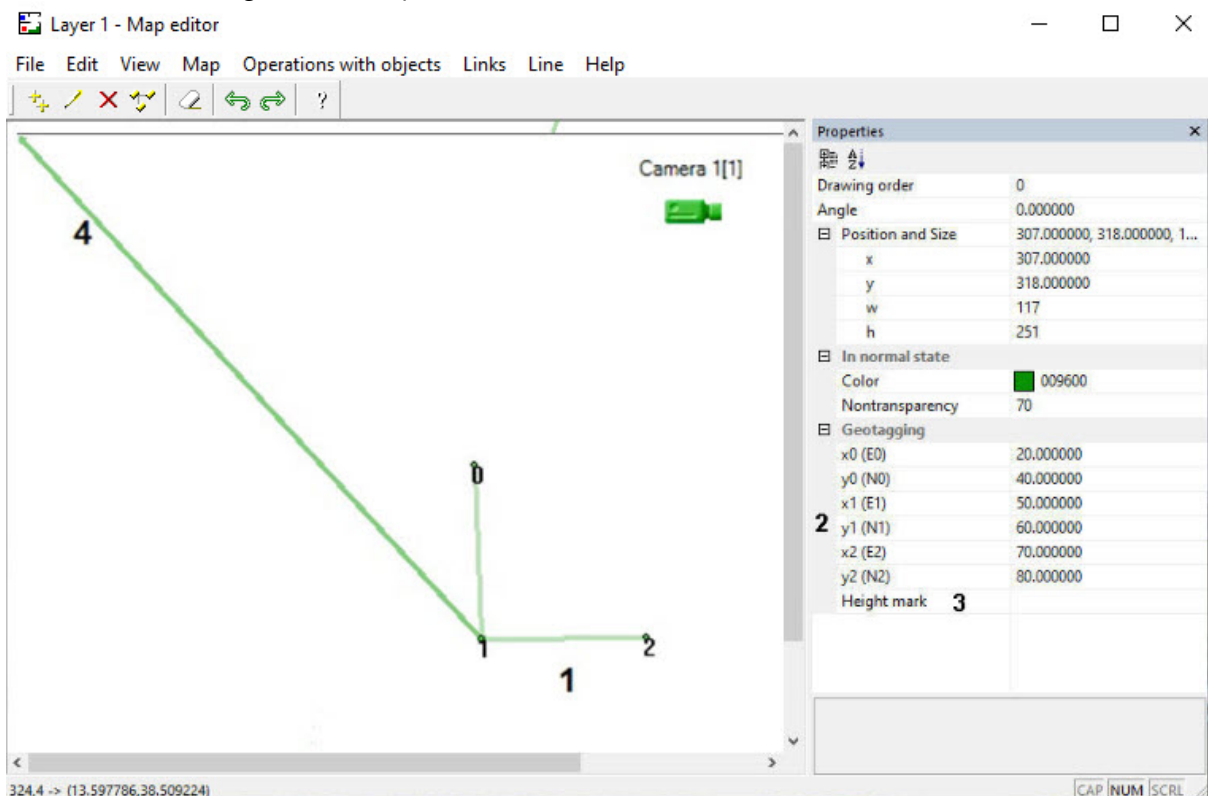

5. Place points 1, 2 and 3 in positions corresponding to points with known coordinates (geographical or relative).
6. Specify coordinates of points 0, 1 and 2 in the **x0, y0, x1, y1, x2** and **y2** fields respectively (2). The x coordinates correspond to longitude, and the y coordinates correspond to latitude.
7. If geographical coordinates of points 0, 1 and 2 are specified correctly, then the axis (4) will point to the north. The coordinates of the point that the mouse cursor is over will be displayed in the status bar in the lower left corner of the *Map Editor* window.

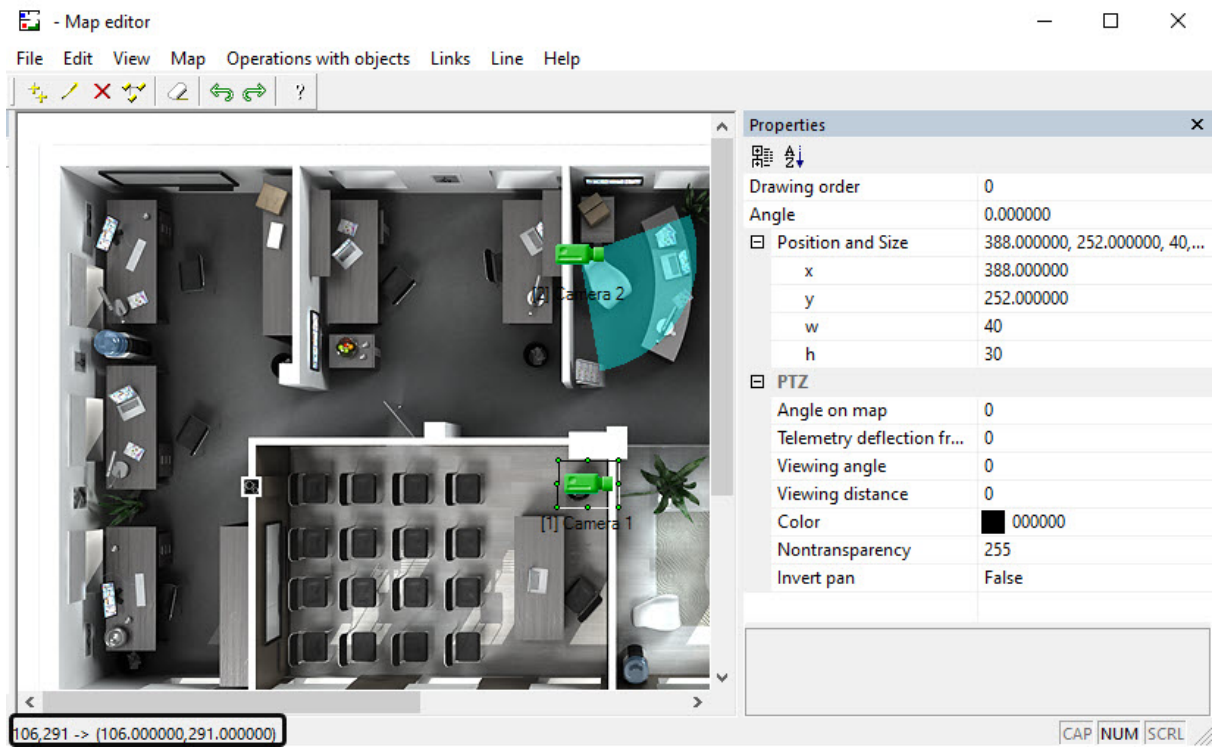

8. Shut down the *Map editor* utility and click the **Apply** button on the settings panel of the corresponding **Layer** object.
9. As a result, the calculated coordinates of the point in the upper right corner of the map will be displayed in the **Georeferencing** field (1).

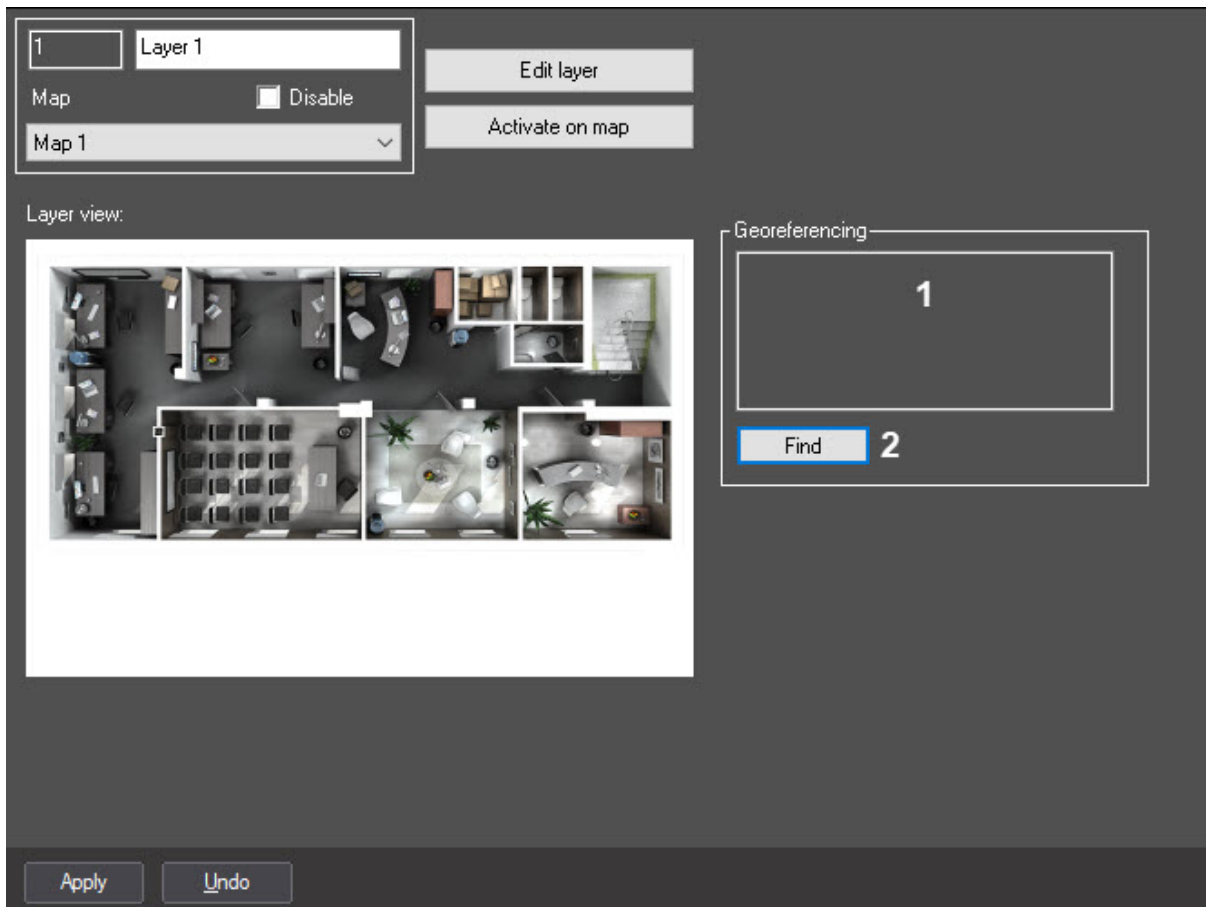

10. Click the **Find** button to check if the settings were made correctly (2). As a result, the Google map will be opened in the default browser showing the specified coordinates.

Map is now bound to coordinate grid.

Setting camera FoV on map

To set the camera FoV on the map, it is necessary to add it to the map as the polygon bounding the area controlled by the camera. A beacon or a security bracelet can be located within the area. For details, see [Attaching objects to the layers of interactive map](#) section in [Administrator's Guide](#). If a beacon or a bracelet is located within the area, the camera can track it and display the video on the tracking monitor (see [Enabling object tracking on interactive map](#)). If a beacon or a bracelet moves to the other video camera area, the first camera will no longer be displayed on the tracking monitor, and the second camera will be tracking the object.

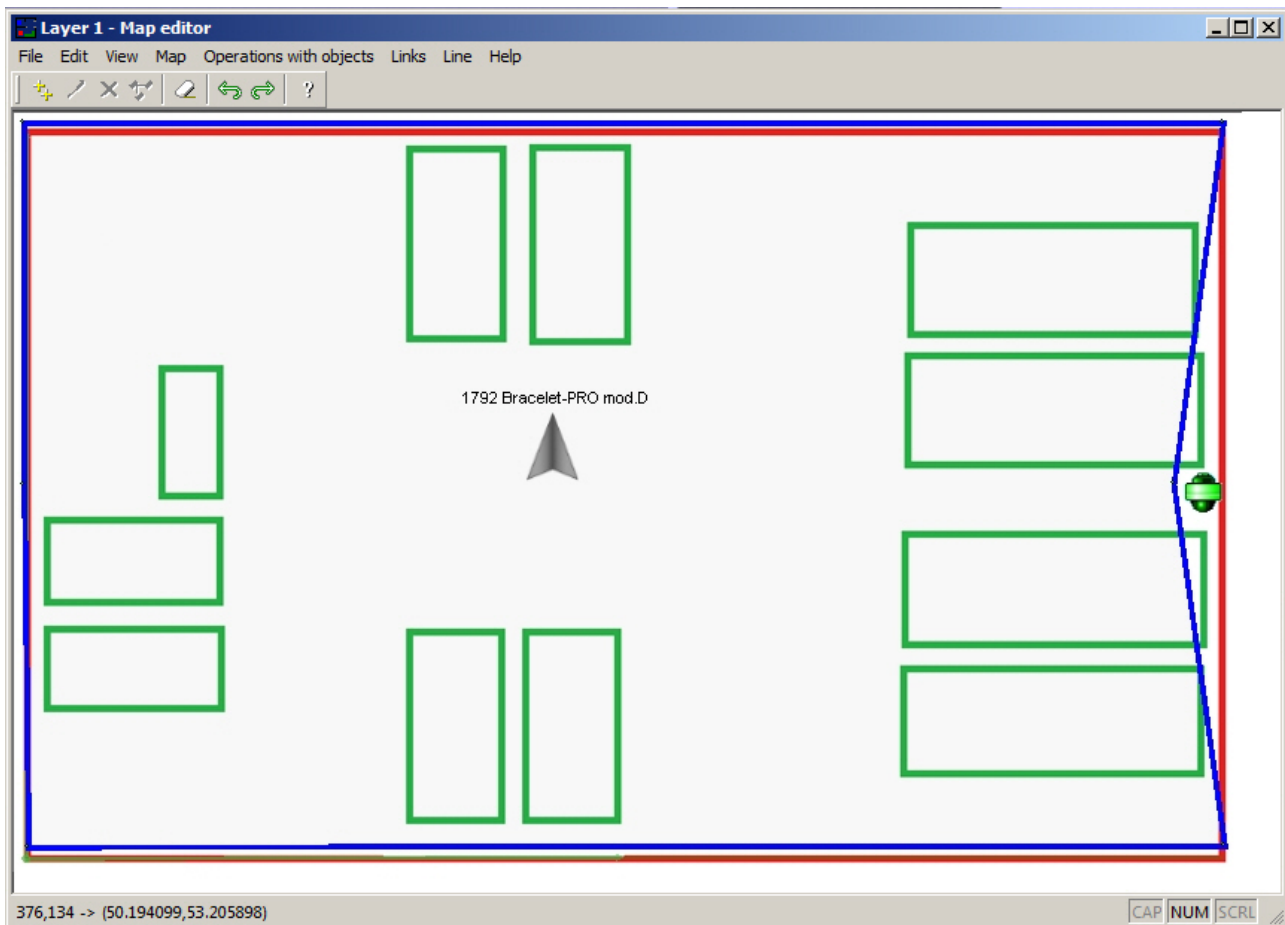

Note

You can configure the camera viewing angle to be displayed on the Map — for details, see [Configuring the camera viewing angle display on the Map](#).

Configuring calibration of points in camera FoV

Before configuring calibration of points in the camera FoV, the PTZ camera is to be configured: create and configure the **Camera** object and create the corresponding **Telemetry controller** and **PTZ device** objects (see [Configuring PTZ IP cameras](#) and [Configuring PTZ devices \(telemetry\)](#)). Calibration of points in the camera FoV is performed on the settings panel of the PTZ device object corresponding to the PTZ camera used to track objects.

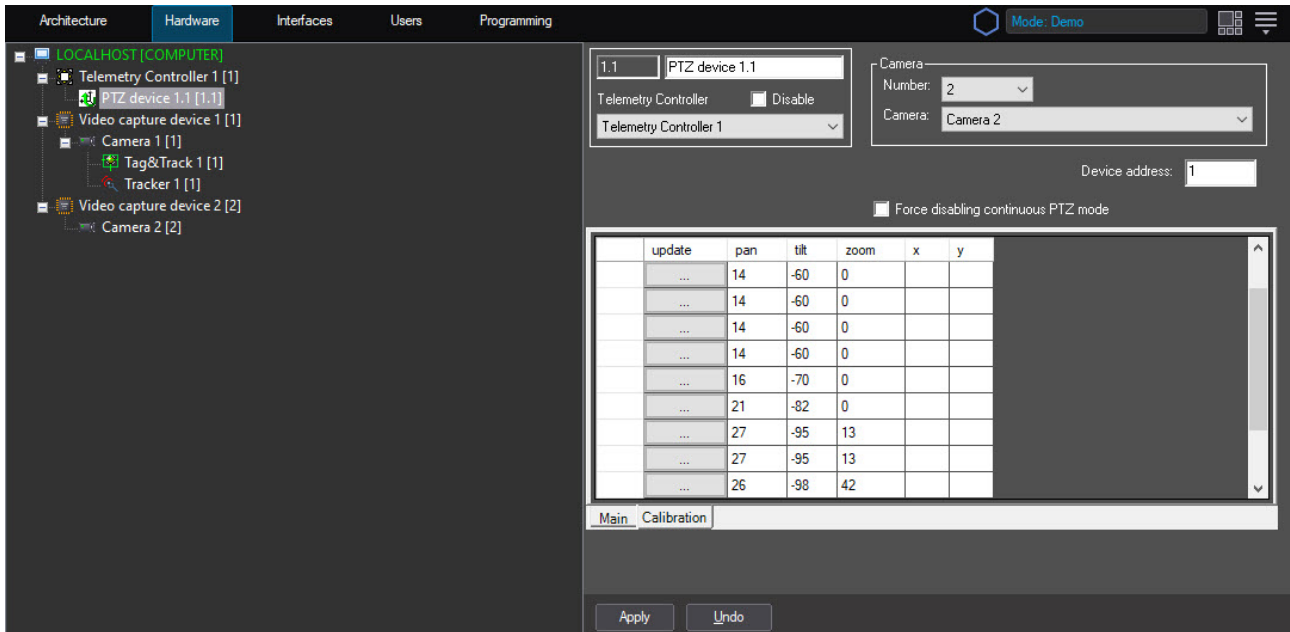

Calibration of points in the camera FoV sets correspondence between absolute coordinates of the camera and the grid of the map (geographical or relative). Minimum of 6 points must be used for calibration. Configure calibration of points in the camera FoV as follows:

1. Go to the settings panel of the **PTZ device** object corresponding to the PTZ camera used to track objects.

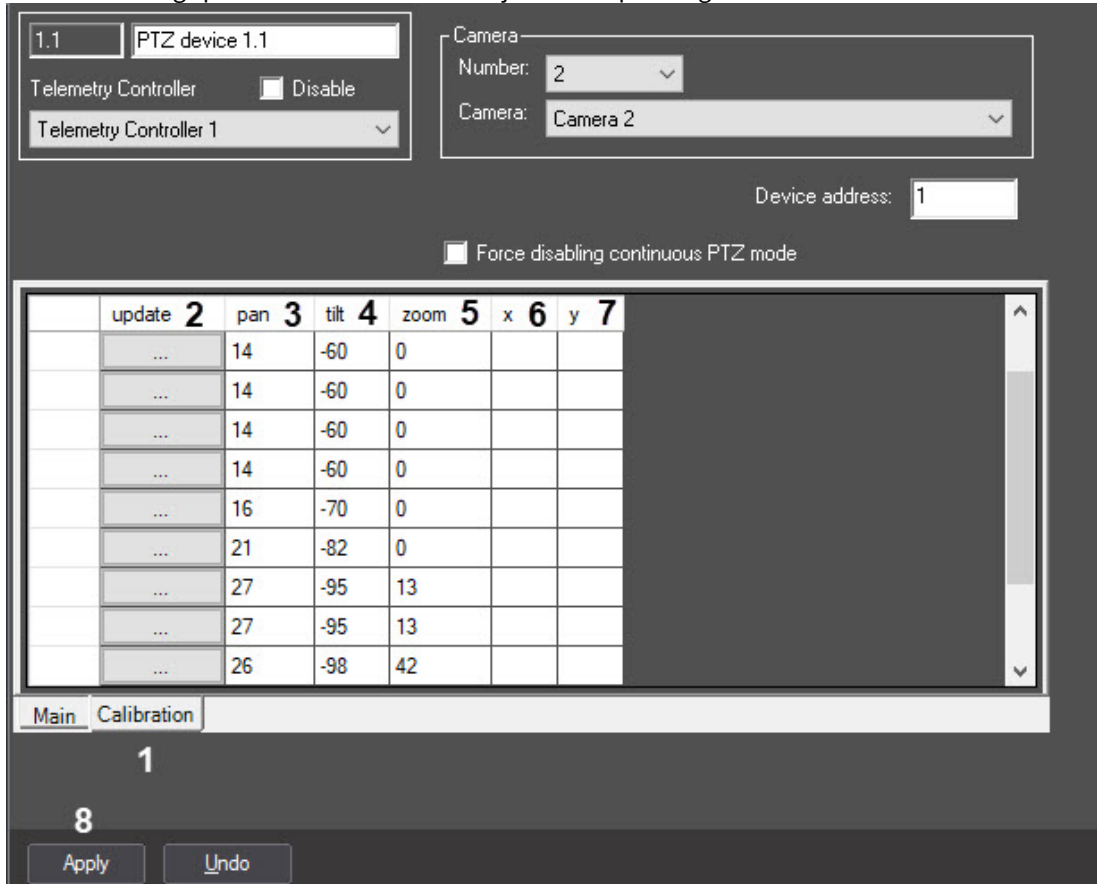

2. Go to the **Calibration** tab (1).
3. Select a point on the interactive map.
4. Rotate the camera lens so that the selected point is located approximately in the center of the video image received from the camera.
5. Click the ... button in the **Update** column (2). As a result, in the corresponding line the **pan** (3), **tilt** (4) and **zoom** (5) fields will be filled with the current absolute coordinates of the camera.
6. In the **x** (6) and **y** (7) fields specify the point coordinates on the map corresponding to the selected position of the camera.
7. Repeat steps 3-6 for all calibration points.
8. Click the **Apply** button (8).

Calibration of points in the camera FoV is now configured.

Examples of script commands for controlling absolute telemetry

Example JScript command for positioning the camera by absolute coordinates.

This command can be used to check if the camera supports this function.

```
DoReactStr("TELEMETRY","1.1","MOVE_ABSOLUTE","tel_prior<1>,x<0.5>,y<1>,zoom<0>");
```

Request absolute telemetry coordinates using JScript command:

```
DoReactStr("TELEMETRY","1.1","GET_ABSOLUTE","");
```

Set absolute telemetry coordinates using JScript command:

```
DoReactStr("TELEMETRY","1.1","MOVE_ABSOLUTE","pan<0>,tilt<0>,zoom<0>,tel_prior<1>");
```

Example script for setting object position on the map by coordinates. If there is geo tagging coordinates are considered geographical.

```
{
  var d = new Date();
  var command = CreateMsg();
  command.Action = "SET_OBJECT_GEOMETRY";
  command.SourceType = "MAP";
  command.SourceId = "1";

  command.SetParam("objtype", "CAM");
  command.SetParam("objid", 1);

  command.SetParam("a", d.getSeconds()*6);
  command.SetParam("x", d.getSeconds());
  command.SetParam("y", d.getSeconds());
  command.SetParam("w", 20+10*Math.sin(Math.PI/d.getSeconds()));
  command.SetParam("h", 20+10*Math.sin(Math.PI/d.getSeconds()));

  DoReactGlobal(command);
}
```

Configuring the camera viewing angle display on the Map

This setting is optional. The displaying of the camera viewing angle on the Map allows you to mark the area on the map which the camera displays on the Tracking Monitor in real time.

In addition, when you select a camera with a configured viewing angle display on the Map, the numerical value of the absolute coordinates (the rotation angle) is displayed on top of the viewing sector (see [Enabling object tracking on interactive map](#)).

To configure the camera viewing angle display on the Map, do the following:

1. Open the *Map Editor* utility for the required layer (see [Creating the layers of the interactive map](#)).
2. Add a **Camera** object icon on a layer (see [Attaching objects to the layers of interactive map](#)) or select an already attached **Camera** object.
3. Open the **Properties** panel if it is not automatically displayed (see [Editing object properties using the Properties panel](#)).

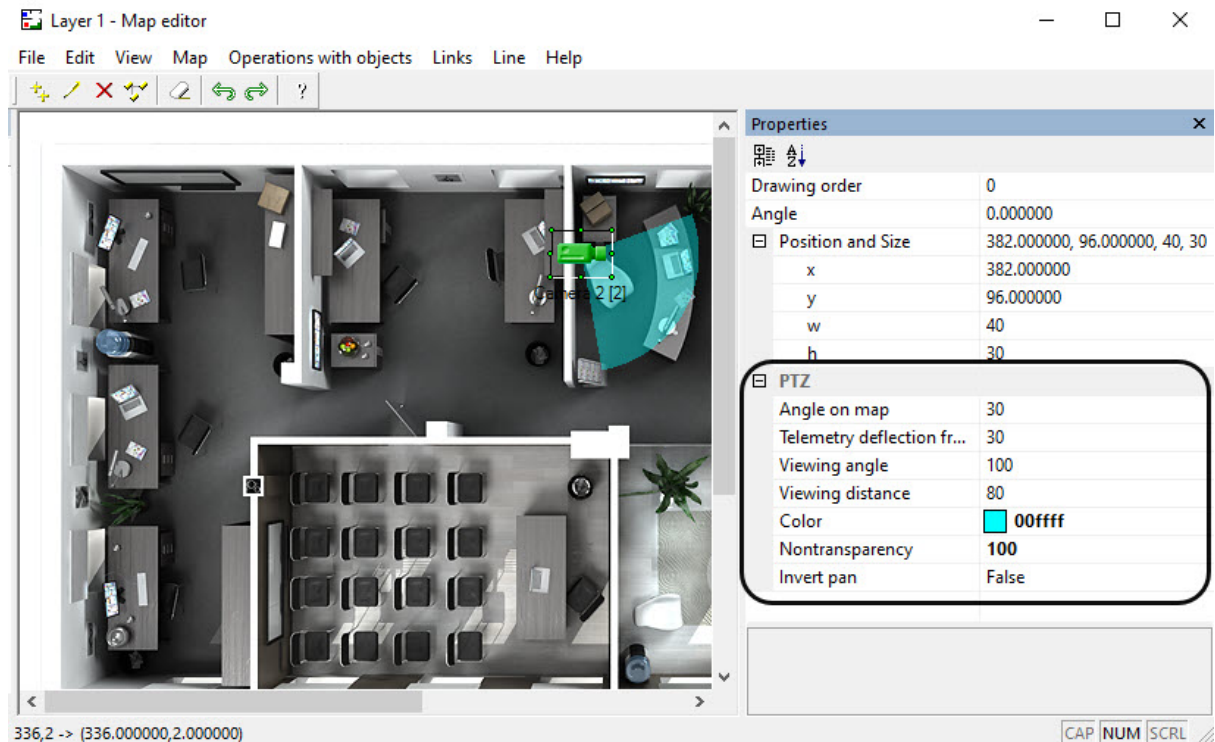

4. On the **Properties** panel in the **PTZ** group, set the viewing angle parameters in the following way:
 - a. **Angle on map** - the direction of the initial vector on the map in degrees.
 - b. **Telemetry deflection from zero** is the real camera deflection from the zero position at the moment of setting up the parameters.
 - c. **Viewing angle** - the size of the camera viewing sector in degrees.
 - d. **Viewing distance** is the radius of the camera viewing sector.
 - e. **Color** - the color of the displayed camera viewing sector.
 - f. **Nontransparency** - the opacity of the displayed camera viewing sector.
 - g. **Invert pan** - invert the panning direction of the camera viewing sector in case if camera sends inverted pan direction (e.g. camera says it turns counter-clockwise while physically turning clockwise).
5. Close the *Map Editor*.
6. Click the **Apply** button in the settings panel of the **Layer** object.

Configuring the camera viewing angle display on the Map is completed.

The color of the camera viewing sector can be changed using the script. The example of a color change command for the JScript is presented below:

```
var msg = CreateMsg();
```

```

msg.SourceType = "MAP";
msg.Action = "OBJECT_ATTRIBUTE";

msg.SetParam("obj_type", "CAM");
msg.SetParam("obj_id", "1"); // Camera object identifier.
msg.SetParam("obj_action", "update_sector");
msg.SetParam("c_clr", "#Aaff0000"); // ARGB format. RGB without transparency can also
be used.

DoReact(msg);
    
```

3.4.12 Patrolling configuration

Patrolling is the automatic transition of the PTZ camera to the specified presets in the specified order and then returning to the starting position. *Axxon PSIM* supports patrolling for Huawei and ONVIF devices.

Create the necessary presets before setting up patrolling in *Axxon PSIM*. This can be done through the IP device web interface or in the *Axxon PSIM* software itself, for example, using the Universal PTZ control panel (see [PTZ control with Universal PTZ control panel](#)).

Creating a route for patrolling

Use the following macro to add a cruise point to the patrolling route (use separate macro for each point):

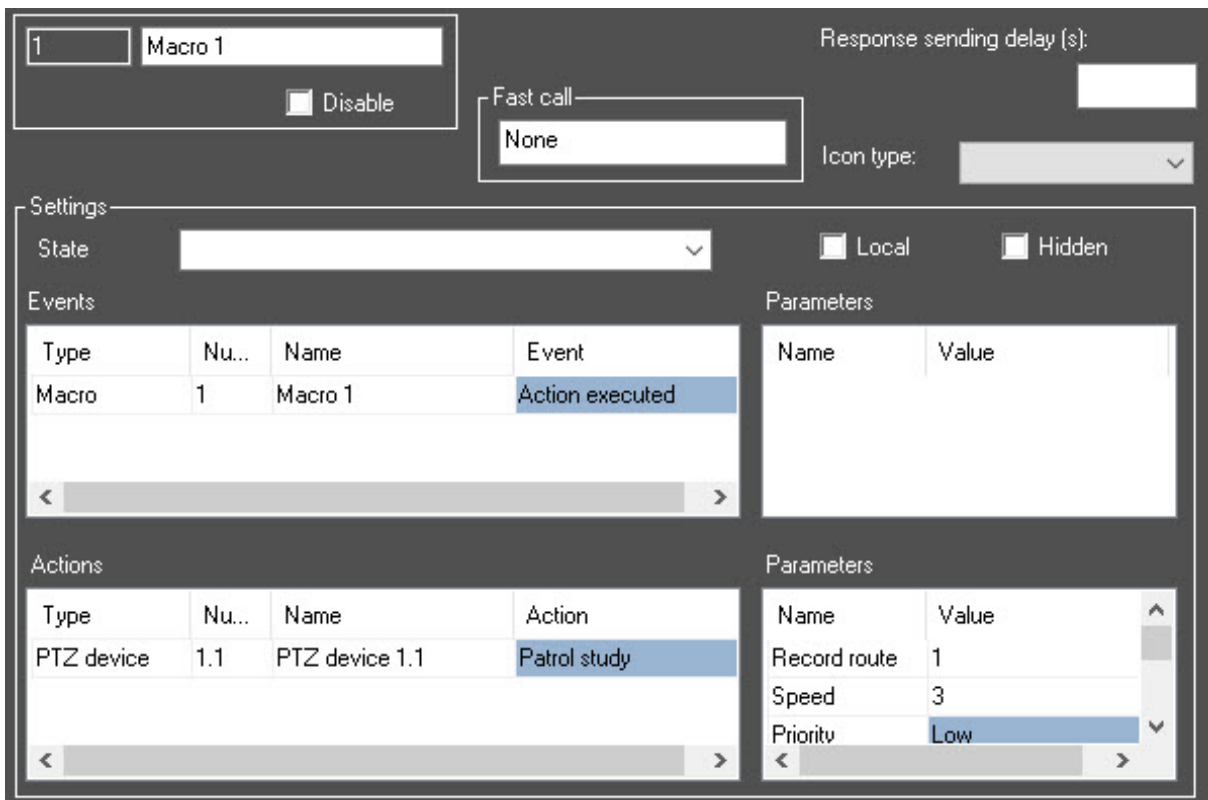

Parameters description:

Parameter name	Description	Value range
Record route	Shows if the point is the last in the route	Yes – this is the last point in the route, save the route. No – another point is expected in the route.
Speed	The speed of the camera movement to the specified point	0 – 10
Priority	The priority of the command to rotate to the specified preset. See Priorities of PTZ control	Low Medium High
Point	The cruise point identifier. <i>Note. If you specify a point number that is more than 1 more than the last one, then the next sequential number will be assigned to the point. For example, point No. 10 cannot be created after point No. 3, the number will automatically be set to 4</i>	1 – 31
Preset	The ID number of the preset corresponding to the cruise point	1 – 255
Delay	Time period during which the device should stay in the preset	3 – 3600
Route	Patrolling route identification number. The identifiers can be set in no particular order, for example, the route No. 8 can be created before route No. 3	1 – 8

Running and stopping the patrolling

Run the following macro to start patrolling:

1 Macro 1 Disable

Fast call: None Icon type:

Response sending delay (s):

Settings

State: Local Hidden

Events

Type	Nu...	Name	Event
Macro	1	Macro 1	Action executed

Parameters

Name	Value

Actions

Type	Nu...	Name	Action
PTZ device	1.1	PTZ device 1.1	Patrol

Parameters

Name	Value
Priority	Low
Route	2

Run the following macro to stop patrolling:

1 Macro 1 Disable

Fast call: None Icon type:

Response sending delay (s):

Settings

State: Local Hidden

Events

Type	Nu...	Name	Event
Macro	1	Macro 1	Action executed

Parameters

Name	Value

Actions

Type	Nu...	Name	Action
PTZ device	1.1	PTZ device 1.1	Patrol stop

Parameters

Name	Value
Priority	Low
Route	2

Consider the following aspects while using these macros:

1. The **Patrol stop** macro acts only after the **Patrol** macro, i.e. if you run the **Patrol** macro, restart *Axxon PSIM* and then try to run the **Patrol stop** macro, the latter one will not be run.
2. If the route number different from the previously started route is specified in the **Patrol stop** command, the patrolling of the current route will be stopped.

4 Installing and configuring security system components guide. Appendices

4.1 Appendix 1. Features of video capture card configuration

4.1.1 Drivers for video capture cards, sensor/relay cards, Guardant and USB Watchdog integrated into Axxon PSIM

Drivers for video capture cards integrated into *Axxon PSIM™* are stored in the **Drivers** folder of the *Axxon PSIM™* installation directory (e.g., C:\Program Files\Axxon PSIM\Drivers). Structure of the **Drivers** folder is given in the table.

Note

The Fs_1_4, SLKEY, TvTuner and SLIO folders in the AxxonSoft directory contain the old version drivers which are needed to ensure the compatibility with the previous versions of *Axxon PSIM*.

Directory	Drivers for video capture cards	Platform supported
AxxonSoft\Fs5_6_8_16	Video capture cards FS5, FS6, FS8, FS16, FX2	x32, x64
AxxonSoft\FX116_416	Video capture cards SL16-200 (FX116), FX416, MS416	x32, x64
AxxonSoft\Ws7	Video capture cards WS7, WS17	x32
AxxonSoft\SL_WD	Sensor/relay cards Stream Labs SL USB IO 4x4, SL USB IO 24x4, SL USB IO 24x4	x32, x64
TUAN\TW6802	Video capture cards SC200Q4 (FS15), SC200Q4 Low profile (FS115), SC300Q16 (FX4), SC300D16 (FX8), SC230N4, SC330Q16 (analogue of SC300Q16)*, SC330D16 (analogue of SC300D16)*	x32, x64
TUAN\CX2581	Video capture card SC310N16 (FX16)	x32, x64
TUAN\AH8400	Video capture card SC390N16 (WS16)	x32, x64
TUAN\TW5864	Video capture card SC3B0N16 (WS216)	x32, x64
TUAN\SA7160	Video capture card SC510N4 (FX HD4)	x32, x64

TUAN\TW2809	Video capture card SC590N4	x32, x64
Guardant	Guardant hardware security key drivers	x32, x64
USBWatchDog	USB Watchdog hardware operational check drivers	x32, x64

* The SC330Q16 and SC330D16 cards have the TW6816 microchip, however it is shown as TW6802 in the device manager.

Note
 Drivers for SC3C0N8-L video capture card should be downloaded from the manufacturer's web site: <https://www.yuan.com.tw/support/download.htm> (or follow the [link](#)).

Important!
 If there is no 64-bit version for the video capture card driver, then this card will not operate in a 64-bit OS.

Note.
 WS6 card is not supported.

4.1.2 Features of video subsystem configuration

Features of video subsystem configuration are given in the table below:

Video capture device	Number of the Video capture device objects for one physical card	Maximum number of the Camera objects for one Video capture device object	Allocation of channel numbers between the Camera objects	Number of the Camera objects (in live mode) for the Video capture device object
FS5	1	16	1-16 (for each physical card)	1
FS6*	4	4	1-16 (for each physical card)	1
FS16	4	4	1-16 (for each physical card)	1
FS8	8	2	1-16 (for each physical card)	1

Video capture device	Number of the Video capture device objects for one physical card	Maximum number of the Camera objects for one Video capture device object	Allocation of channel numbers between the Camera objects	Number of the Camera objects (in live mode) for the Video capture device object
FX2	2	4	1-8 (for each physical card)	1
SC200Q4 (FS15)	1	4	1-4 (for each physical card)	1
SC200Q4 Low profile (FS115)	1	4	1-4 (for each physical card)	1
SC230N4	4	1	randomly	1
SC300Q16 (FX4)***	4	4	1-4 (for each Video capture card object)	1
SC300D16 (FX8)***	8	2	1-2 (for each Video capture card object)	1
SC310N16 (FX16)	16	1	randomly	1
WS7	4	1	randomly	1
SC390N16 (WS16)	16	1	randomly	1
WS17	4	1	randomly	1
SC3B0N16 (WS216)	16	1	randomly	1
SL16-200 (FX116)****	1	16	1-16 (for each physical card)	8
FX416	1	16	1-16 (for each physical card)	16
MS416	1	16	1-16 (for each physical card)	16

Video capture device	Number of the Video capture device objects for one physical card	Maximum number of the Camera objects for one Video capture device object	Allocation of channel numbers between the Camera objects	Number of the Camera objects (in live mode) for the Video capture device object
DS4016HCI(R)	1	16	1-16 (for each physical card)	16
SC510N4 (FX HD4)**	4	1	randomly	1
SC590N4	4	1	randomly	4
SC330Q16	4	4	1-4 (for each Video capture card object)	1
SC330D16	8	2	1-2 (for each Video capture card object)	1
SC3C0N8-L	8	1	1	1

* If the FastBoot mode is ON on Windows 10, reboot the OS from Start-Restart menu after first run of Server after video capture card installation. To avoid this, disable FastBoot by changing the following registry keys:

HKEY_LOCAL_MACHINE\SYSTEM\CurrentControlSet\Control\Session Manager\Power\ **HiberbootEnabled** set to **0**

HKEY_LOCAL_MACHINE\SYSTEM\CurrentControlSet\Services\luaflv\ **Start** set to **0**

The FastBoot can also be disabled from Control Panel. Go to **Control Panel - All Control Panel Items - Power Option**, then click **Choose what the power buttons do - Change settings that are currently unavailable** and uncheck **Enable Quick Launch**.

PCI channels are to be allocated between the **Video capture device objects created for SC510N4 (FX HD4) video capture card, taking into account the numbers of external HDMI connectors indicated on the card.

*** When a video subsystem is built using SC300Q16 (FX4) or SC300D16 (FX8) or SC330Q16 (analogue of SC300Q16) or SC330D16 (analogue of SC300D16) video capture card, take into account that each color of BNC video input of interface cable conforms with a certain PCI channel specified in the settings of the Video capture device object.

Value of PCI channel	Colour of BNC video input
00	Blue
01	Green
02	Yellow

Value of PCI channel	Colour of BNC video input
03	Black
2nd interface cable	
04	Blue
05	Green
06	Yellow
07	Black

For example, if one SC300Q16 (FX4) video capture card is used and video cameras are connected to blue BNC video inputs, then the **Camera** objects under the **Video capture device** object correspond to these video cameras (with 00 value for PCI channel) in *Axxon PSIM™*.

⚠ Attention!

Specify the **min** value to the **Speed** parameter in the settings panel of the **Video Capture Device** object if more than 8 cameras are connected to SL16-200 (FX116) card (see the [The Settings panel of the Video Capture Device object](#) section of the [Administrator's Guide](#) document). This value corresponds to 8 fps in the PAL format. Otherwise, noise (distortions) on video can occur.

📘 Note.

WS6 card is not supported.

4.1.3 Features of audio subsystem configuration

Features of audio subsystem configuration are given in the table below:

Video capture device	Number of the Audio card objects for one physical card	Maximum number of the Microphone objects for one Audio card object	Allocation of channel numbers between the Microphone objects under one Audio card object
FS5 (FS 6)	1	2	#0 - #1
FS6 (FS 6)	4	2	#0 - #1
FS16 (FS 6)	4	2	#0 - #1

Video capture device	Number of the Audio card objects for one physical card	Maximum number of the Microphone objects for one Audio card object	Allocation of channel numbers between the Microphone objects under one Audio card object
FS8 (FS 8)	8	2	#0 - #1
FX2 (FS 6)	2	2	#0 - #1
SC200Q4 (FS15, TW6802 PCI, Analog WaveIn)	1	1	only #0
SC200Q4 Low profile (FS115)	1	1	only #0
SC230N4	4	1	only #0
SC300Q16 (FX4, TW6802 PCI, Analog WaveIn)	4	1	only #0
SC300D16 (FX8, TW6802 PCI, Analog WaveIn)***	8	1	only #0
SC310N16 (FX16, CX2581 PCI, Analog WaveIn)	16	1	only #0
WS7 (WS 7)	4	2	#0 - #1
SC390N16 (WS16, AH8400 PCI, Analog WaveIn)	16	1	only #0
WS17 (WS 7)	4	2	#0 - #1
SC3B0N16 (WS216, TW5864 PCI, Analog WaveIn)	16	1	only #0
SL16-200 (FX116, SLFXR)	1	16	#0 - #15

Video capture device	Number of the Audio card objects for one physical card	Maximum number of the Microphone objects for one Audio card object	Allocation of channel numbers between the Microphone objects under one Audio card object
FX416 (SLFXR)	1	16	#0 - #15
MS416(SLMSR)	1	32	#0 - #31
SC510N4 (FX HD4, SA7160 PCI, Analog WaveIn)*	4	1	only #0
SC590N4**	4	1	#0 - #1
SC330Q16	4	1	only #0
SC330D16	8	1	only #0
SC3C0N8-L	8	1	only #1

* PCI channels are to be allocated between the **Audio card** objects created for SC510N4 (FX HD4) video capture card, taking into account the numbers of external HDMI connectors indicated on the card.

** Audio input is performed via both SDI connectors and analog inputs. **Either** SDI or analog input can be used at the same time for each card. #0 channel corresponds to the SDI, and #1 – to the analog input. Therefore, it is possible to simultaneously connect audio to the card via either 4 SDIs, or 3 SDIs and one analog input, or 2 SDIs and 2 analog inputs.

Restart the *Axxon PSIM* to apply settings.

*** FS8 video capture card allows capturing 16 audio channels with digitization quality up to 32 kHz. Eight right (#1) channels are used to connect to external DB9-M connector.

Pinout of an audio port of FS8 card:

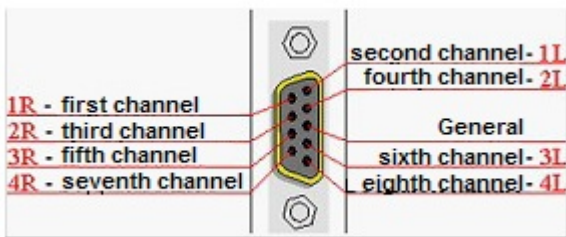

Eight left (#0) channels are used to connect to internal 6-pin connector using 8-channel audio cable. FS8 card with an audio cable:

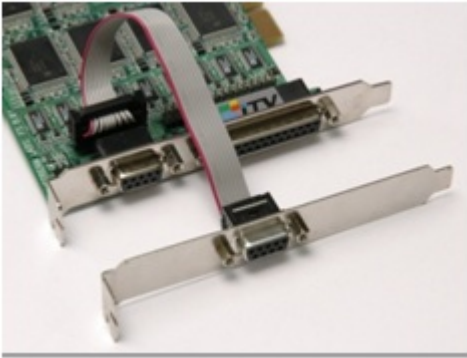

Pinout of an audio port of an audio cable:

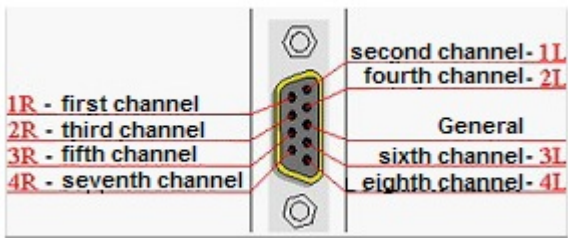

Optionally there is an adapter for DB9-M connector (audio input port on FS8 card) with 8 RCA-F connectors that make audio source connection easier.

⚠ Attention!

Signs on audio cable connectors do not conform with numbers of card channels. Right channels are performed in DB9 connector, left channels are performed in DB9 cable.

Channels in DB9 connector:

Sign on audio cable connector	Number of a card channel
1R	1R
2R	3R
3R	5R
4R	7R
1L	2R
2L	4R
3L	6R

Sign on audio cable connector	Number of a card channel
4L	8R

Channels in DB9 cable:

Sign on audio cable connector	Number of a card channel
1R	1L
2R	3L
3R	5L
4R	7L
1L	2L
2L	4L
3L	6L
4L	8L

Note.

WS6 card is not supported.

4.2 Appendix 2. IP device configuration in the Windows OS

4.2.1 Configuration of IP devices by the example of Axis camera

IP-devices in Windows OS are configured with the software bundled with the network module.

To configure the IP device in Windows OS, the following software bundled with the device is in use:

1. Software bundled with the network device package. This software allows:
 - a. Searching for the network devices connected to the local network computers.
 - b. Assigning initial IP addresses (without routing).

Note

An initial IP-address is required to enable access to the home pages of the devices installed on the embedded Web Servers.

2. The Web Server module of the network device. This module contains home pages of all connected network devices. The Web Server module allows:
 - a. Configuring network devices taking into account routing.
 - b. Configuring operation modes of the network devices with video and audio signals.
 - c. Playing back video from the network devices in the standard Web-browser mode.

Searching for IP devices

The software package consists of various software including different utilities designed to search for the network devices of the same type connected to the local network computers.

IPUtility.exe utility is used to search for connected network cameras when Axis cameras are in use. IPUtility.exe utility is bundled with Axis cameras and is stored in the Axis installation software directory.

To search for Axis IP cameras connected to the local network computers, using the IPUtility.exe utility, do the following:

1. Select **Search** on the IPUtility.exe tools panel.

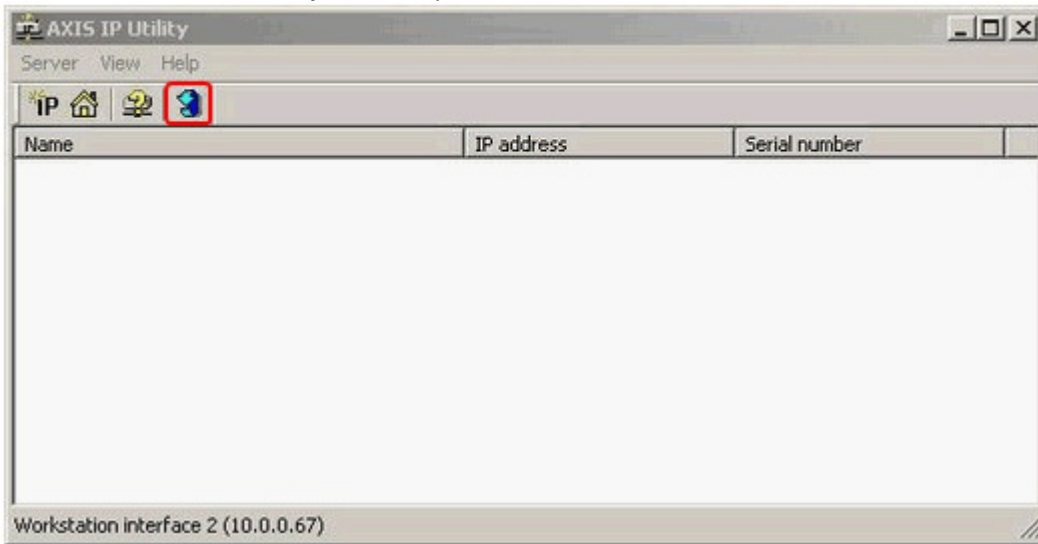

The search for Axis IP cameras starts as soon as the **Search** button is clicked.

2. The list of Axis IP cameras available in the local network is displayed in the IPUtility.exe window.

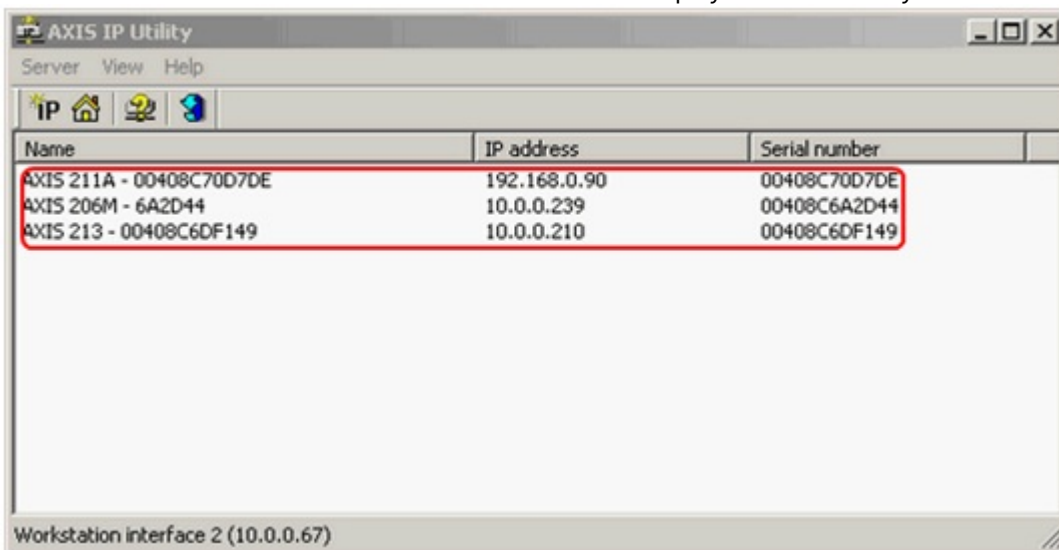

Assigning network addresses to IP devices

To ensure correct operation of the network devices within the local video surveillance system, their IP addresses are to be configured correctly. IP addresses are configured using the utilities bundled with the software kit.

Before assigning an IP address to the Axis network camera, do the following:

1. Make sure that the Axis network camera is connected to the mains and correctly connected to the telecommunication network.
2. Get a unique IP address from the network Administrator.
3. Make sure that the device displays its own MAC address correctly. The MAC address of Axis cameras is the same as the serial number of the camera.

Note

The examples below use a computer with 192.168.0.1 IP address, whereas an Axis camera is installed to 192.168.0.90 IP address. The MAC address for an Axis camera is 00408C70D7DE. The addresses given as an example are not to be used; always consult your network Administrator before assigning an IP address.

Note

Selecting an IP address to be assigned to an IP camera, keep in mind that the initial IP address of the camera connected for the first time is to correspond to the same subnetwork as the IP address of computer. Later on, if required, the IP address can be modified using the Web Server of the device.

To assign an IP address to the Axis network camera, do the following:

1. Check that the IP address to be assigned to the Axis network camera is not used by any other devices. The IP address in Windows OS is checked using the command line. To display the command line on the monitor, select the **Command Prompt** in the **Start** menu.

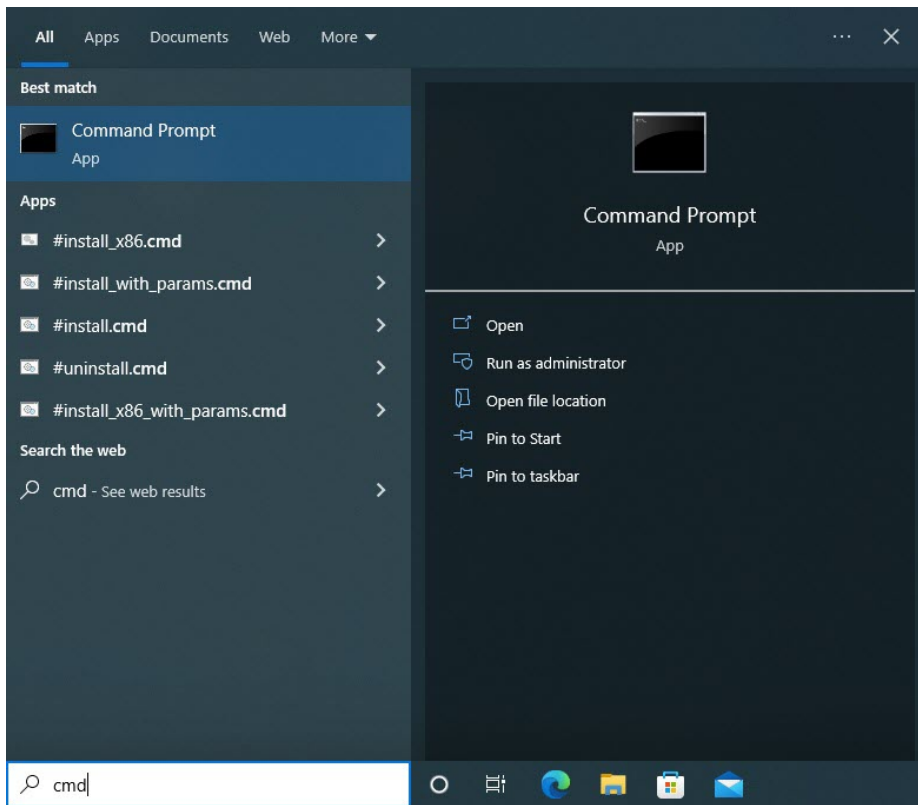

Now type the **cmd** command in the **Open** field of the **Run** dialog box and click the **OK** button to approve the entry.

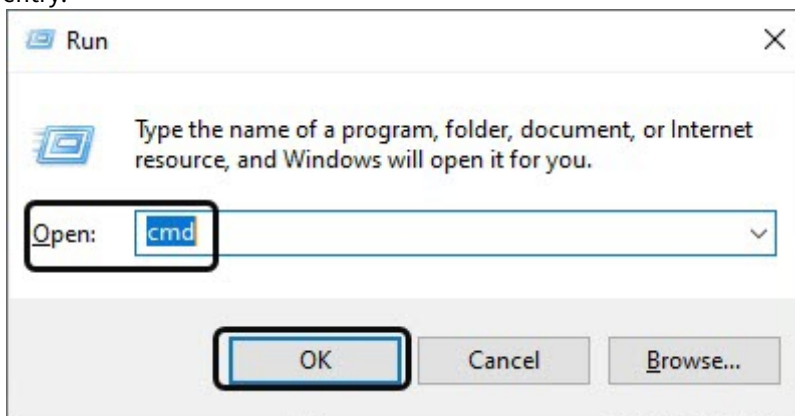

As a result, the command line is displayed on the screen.

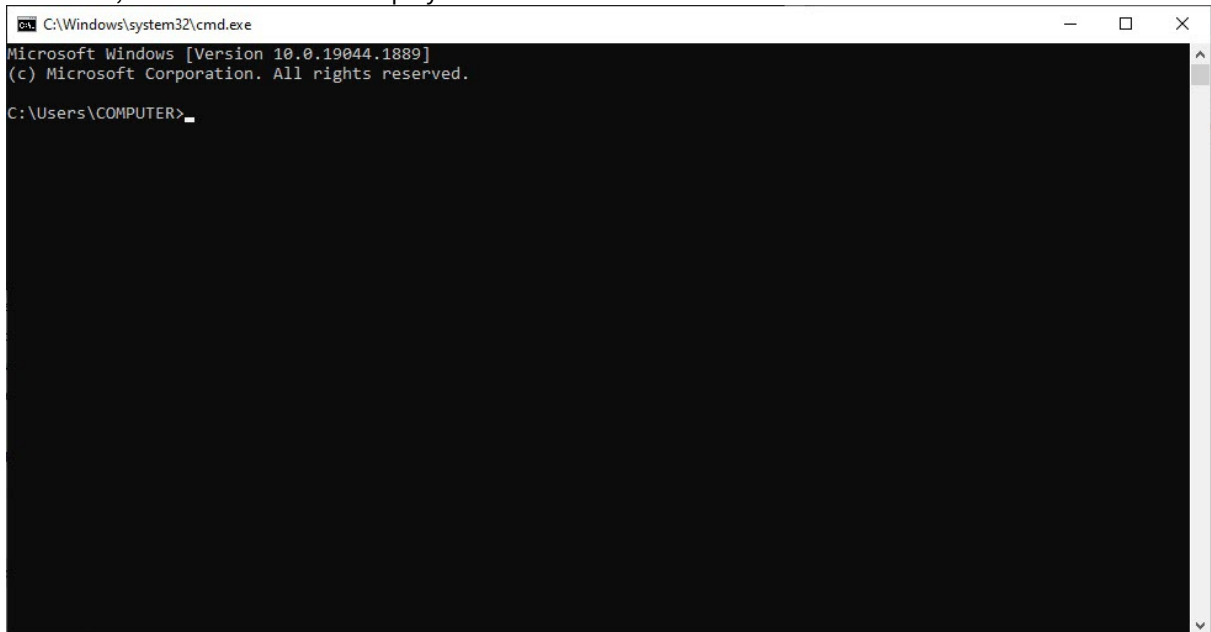

```
C:\Windows\system32\cmd.exe
Microsoft Windows [Version 10.0.19044.1889]
(c) Microsoft Corporation. All rights reserved.

C:\Users\COMPUTER>
```

To check the selected IP address, type the **ping 192.168.0.90** command in the command line. If the given IP address does not belong to any other device, then there is the **Request timed out** message on the screen.

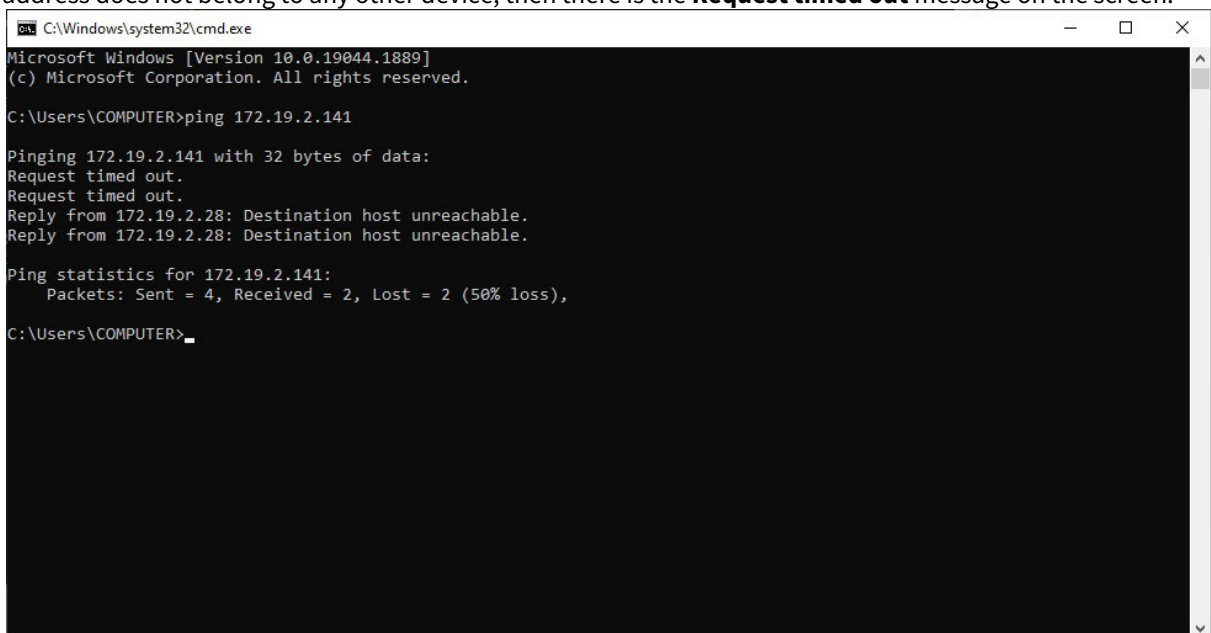

```
C:\Windows\system32\cmd.exe
Microsoft Windows [Version 10.0.19044.1889]
(c) Microsoft Corporation. All rights reserved.

C:\Users\COMPUTER>ping 172.19.2.141

Pinging 172.19.2.141 with 32 bytes of data:
Request timed out.
Request timed out.
Reply from 172.19.2.28: Destination host unreachable.
Reply from 172.19.2.28: Destination host unreachable.

Ping statistics for 172.19.2.141:
    Packets: Sent = 4, Received = 2, Lost = 2 (50% loss),

C:\Users\COMPUTER>
```

2. Assign the required IP address to the Axis camera. Assign the selected IP address as follows:
 - a. Start the **IPUtility.exe** utility.
 - b. Start searching for all Axis IP cameras (see [Searching for IP devices](#) section).
 - c. Highlight the line containing the required IP camera in the list of Axis IP cameras connected to the local network.

- d. Select the **Set IP Address** item in the **Server** dropdown list in the main menu of the **IPUtility.exe** utility.

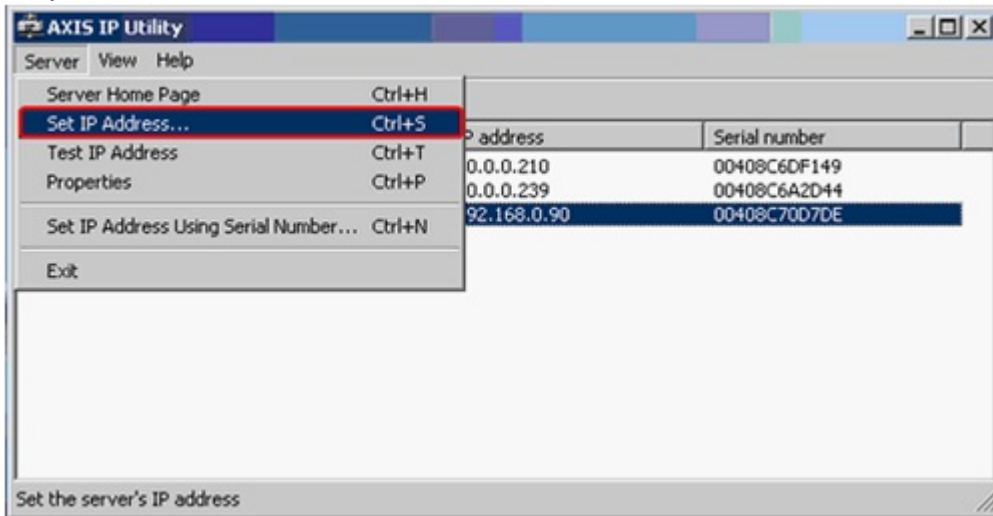

- e. Type the required IP address on the **Set IP Address** panel.

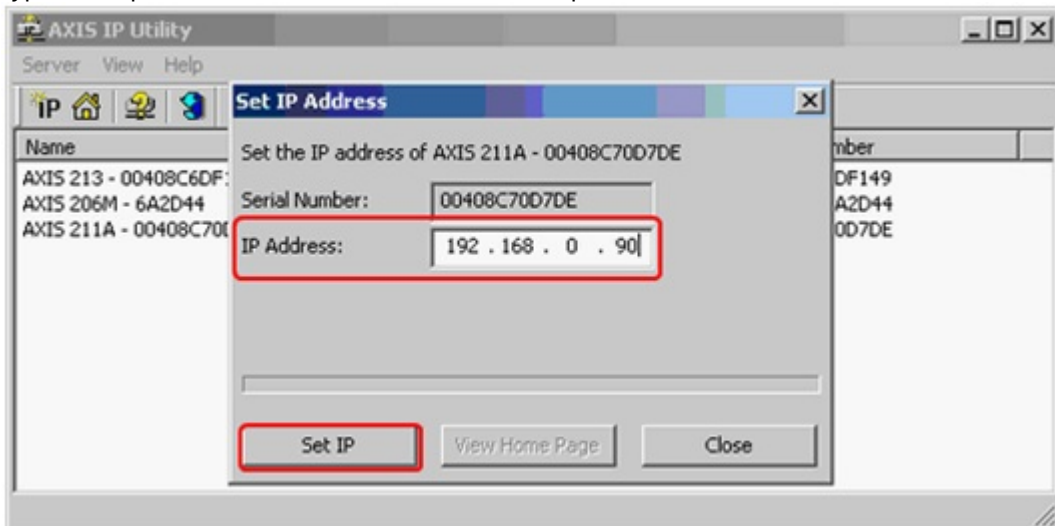

- f. Confirm the IP address assigned to the Axis network camera by clicking the **Set IP** button.

As soon as the above operations are done, IP address settings of the network device are enabled.

Note

To prevent possible failures of the camera, check the assigned IP address again.

3. Check the IP address assigned to the Axis network camera.

Note

The IP address is checked with the use of the command line (see the 1st item of this instruction). If the IP address is set correctly, then following message is displayed in the command line window in reply to the **ping 192.168.0.90** command:

```

C:\Windows\system32\cmd.exe
Microsoft Windows [Version 10.0.19044.1889]
(c) Microsoft Corporation. All rights reserved.

C:\Users\COMPUTER>ping 172.19.2.141

Pinging 172.19.2.141 with 32 bytes of data:
Reply from 172.19.2.141: bytes=32 time=1ms TTL=64
Reply from 172.19.2.141: bytes=32 time<1ms TTL=64
Reply from 172.19.2.141: bytes=32 time=3ms TTL=64
Reply from 172.19.2.141: bytes=32 time<1ms TTL=64

Ping statistics for 172.19.2.141:
    Packets: Sent = 4, Received = 4, Lost = 0 (0% loss),
    Approximate round trip times in milli-seconds:
        Minimum = 0ms, Maximum = 3ms, Average = 1ms

C:\Users\COMPUTER>

```

The IP address is now assigned to the Axis camera. If assignment of the IP-address to the Axis camera is successful, then proceed to the network configuration of the device using the embedded Web Server.

How to call the Web Server home page of IP device

The home page of a network device is automatically created on the Web Server of the network device as soon as the IP address is assigned to the device using the IPUtility.exe utility (see [Assigning network addresses to IP devices](#) section).

Webpage of IP device can be downloaded in two ways:

1. Specify address manually. For this:
 - a. Start Internet Explorer.
 - b. Type the address in the **Address** line: `http://assigned IP-address` (for instance, `http://192.168.0.90`) and click the **Enter** key.



- c. Type a user name and password to access the home page of the network device. The data specified in the **User name** and **Password** fields can be found in the documentation to the add-on network

device.

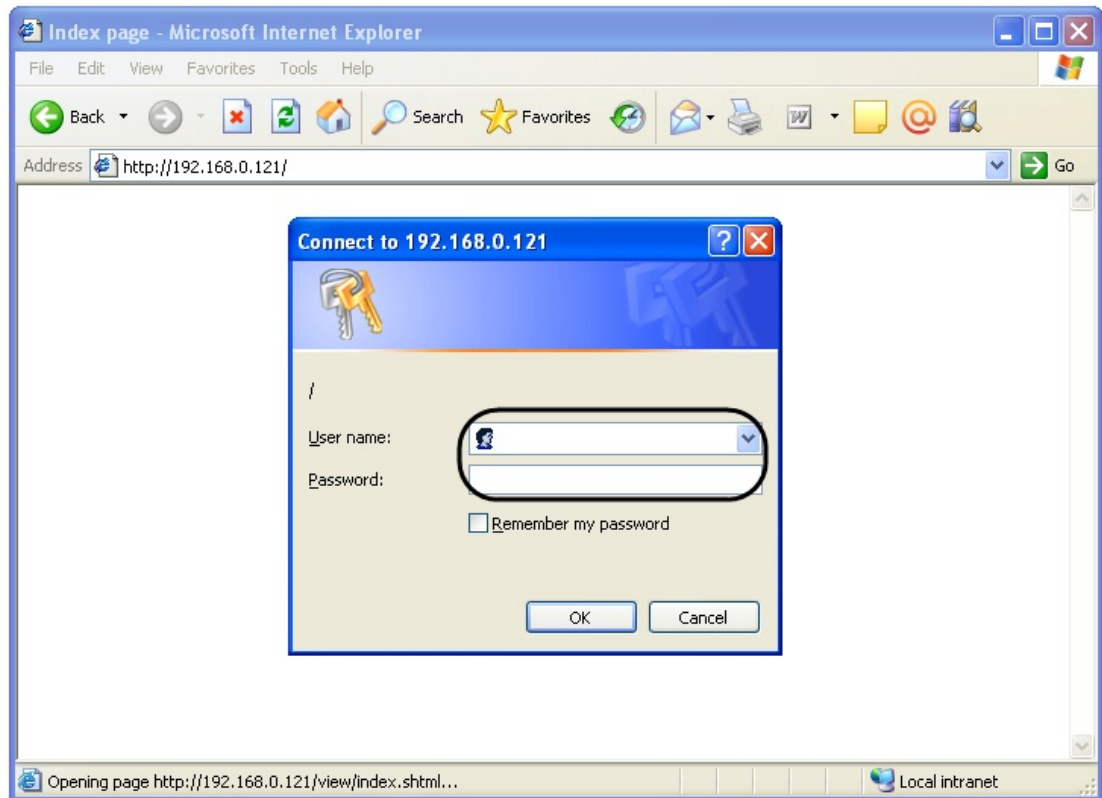

- d. Click **the OK** button after specifying the user name and password.
2. On the settings panel of the **Camera** object corresponding to the IP device. Holding Shift click the **Video** button on the settings panel of the object.

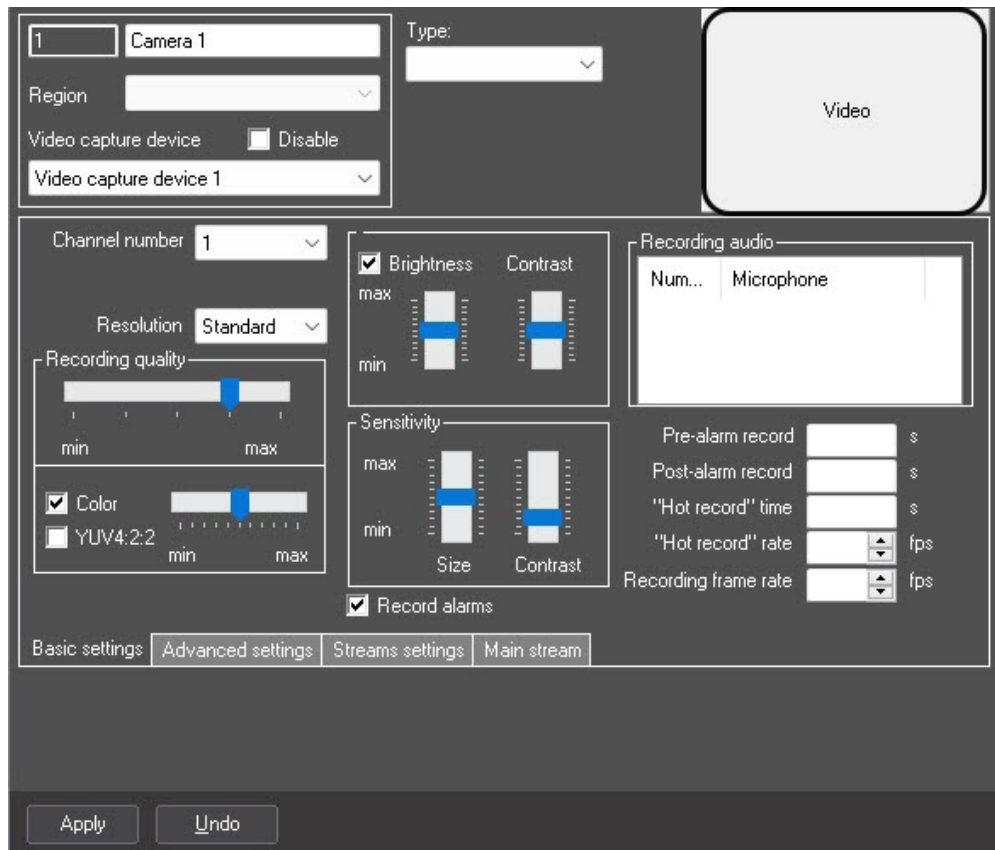

A webpage of *Web server* of IP device appears in the default browser.

If Drivers Pack cannot provide connection string to *Web server* of IP device, then *Web server* is attempted to be accessed at <http://login:password@camera-ip/>.

Note.

This feature is not available if Internet Explorer is the default browser.

The feature is supported by Axis and Bosch cameras.

If the `hardcoded_hyperlink` registry key is set, the address of the network device *Web server* home page may differ from the address specified in the device documentation (see the [Registry keys reference guide](#)).

The screen displays the viewing tile of the IP camera if a network camera is in use or one of the analog cameras connected to the network Server, if the network Server is in use.

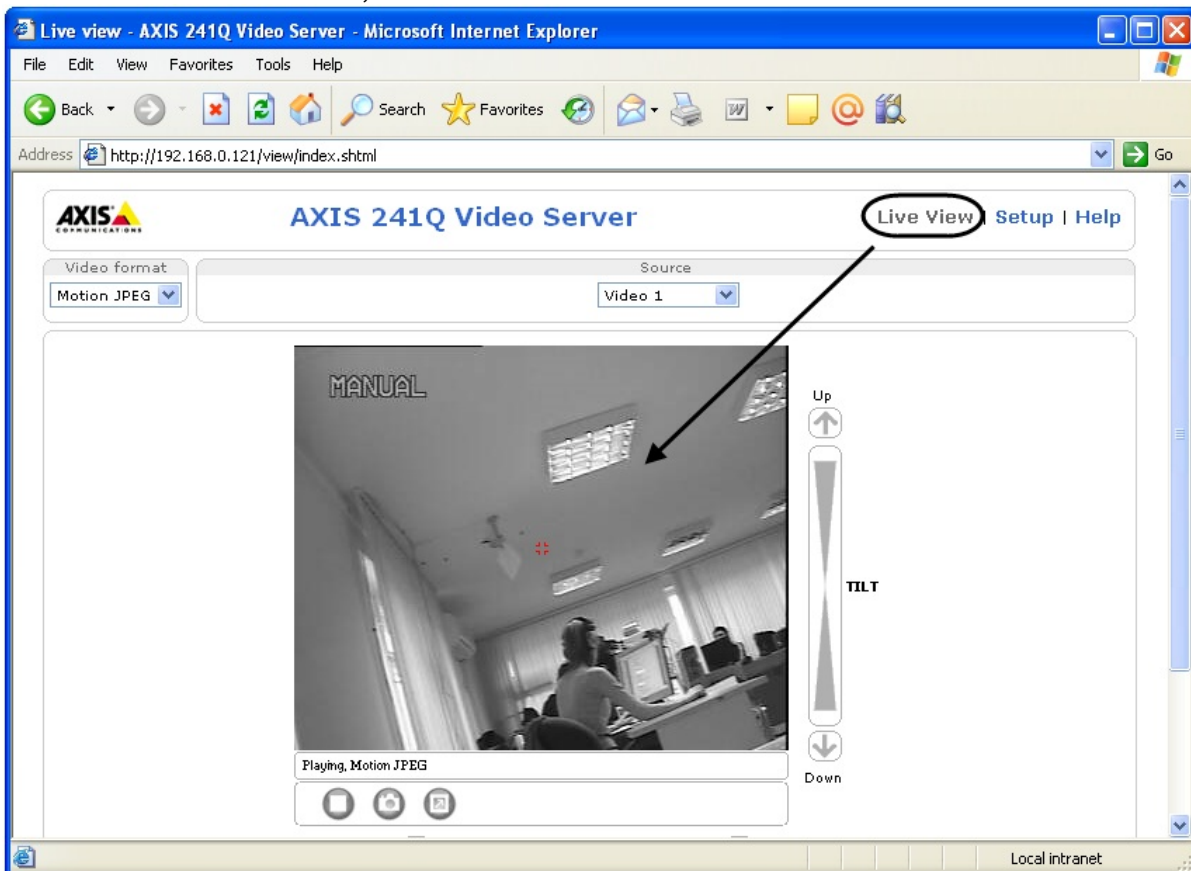

Note

If an IP camera gives no image, then check if the IP address is assigned correctly (see [Assigning network addresses to IP devices](#) section).

Configuring network parameters of IP-devices using the Web Server

Network parameters of the IP devices are configured using the interface of the embedded Web Server of the network device.

Note

Configuration of the network parameters of IP devices using the Web Server is a compulsory procedure.

To configure IP devices when working in the local network that is either equipped or non-equipped with the routers, do the following:

1. Start Internet Explorer.
2. Open the home page of the network device (see [How to call the Web Server home page of IP device](#) section).

- Open the **Setup** section in the Web Server feature menu of the Web browser home page.



- Select the **TCP/IP** tab in the **Setup** section. Specify the **IP address**, **Subnet mask** and **Default router** in the given tab. To confirm the settings, click the **Save** button.

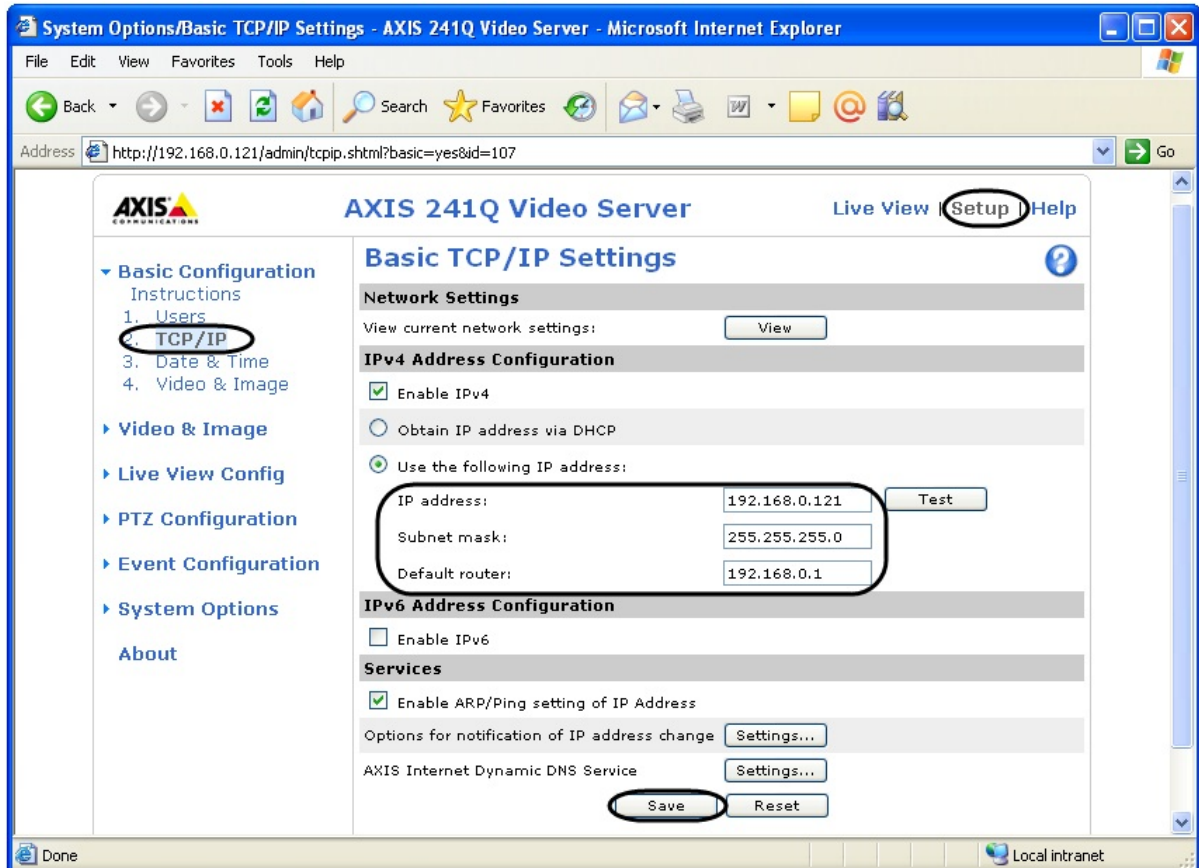

Specify the assigned IP-address of the network device in the **IP address** field (see [Assigning network addresses to IP devices](#) section).

In the **Subnet mask** field Specify the mask of the subnet to which the network device is connected.

When entering data in the **Default router** field, the following should be taken into consideration:

- a. If the Server and IP camera are in the same subnetwork, then the **Default router** parameter is not to be specified.

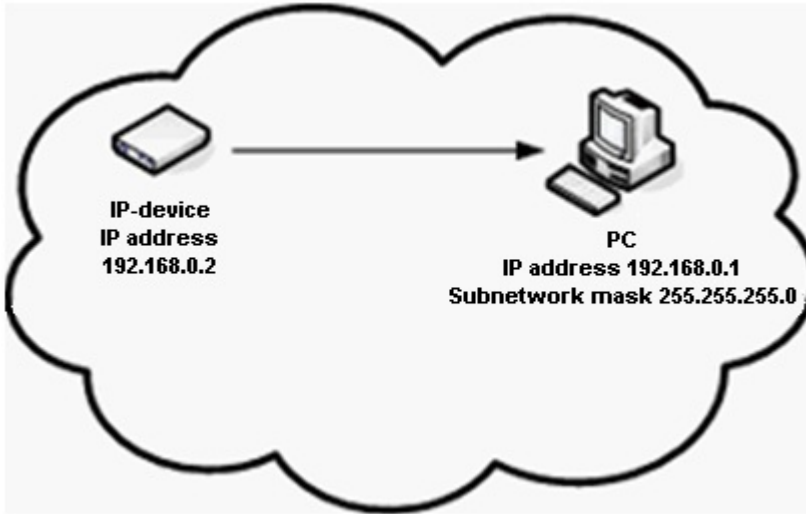

- b. If the Server and IP camera are in different subnetworks, then the **Default router** parameter is to be specified.

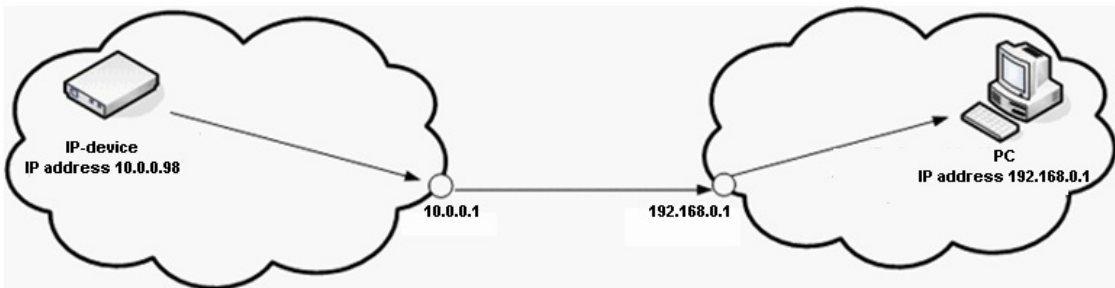

- c. The IP address of the **Default router** is to match the subnetwork that the IP address of the camera belongs to.

Note

The camera does not operate if the IP address of the router is wrong or not specified at all.

IP-device
IP address 10.0.0.98

10.0.0.1

192.168.0.1

PC
IP address 192.168.0.1

5. Select **System Options / Ports & Devices / RS232** tab in the **Setup** section. Select **Pan Tilt Zoom** in the **Port 1 Usage** field to show that the given interface is used for telemetry. To confirm the settings, click the **Save** button.

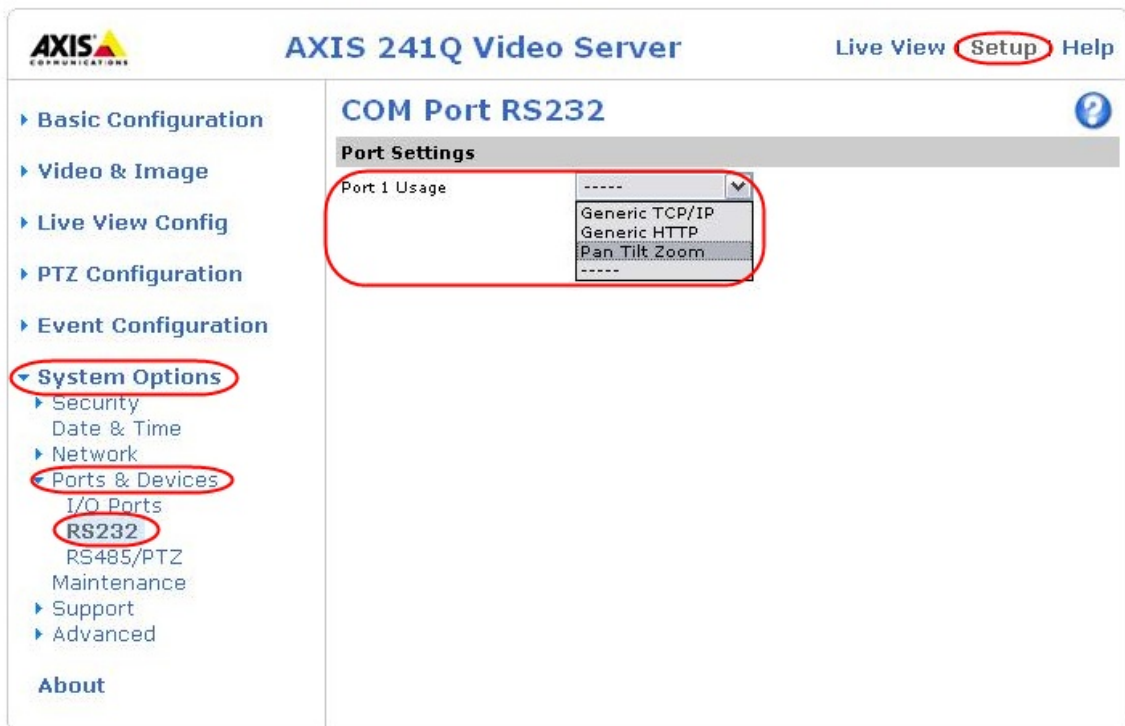

Network parameters of the IP devices are now configured.

Now proceed to the configuration of IP devices in *Axxon PSIM™*.

4.2.2 Features of configuring Axis IP devices

It is strongly recommended to keep the default value of the **Friendly name** parameter unchanged for Axis IP device with enabled and supported *Bonjour* option. If there is an arbitrary value of the **Friendly name** parameter for Axis IP device, then search for a connected device in *Axxon PSIM™* will give incorrect results concerning this IP device.

Note

The **Friendly name** parameter is configured via the Web interface of IP device: **Setup -> System options -> Network -> Bonjour**

Note

The **Friendly name** parameter has the following default value: AXIS <model name> - <mac address>, where <model name> is model of Axis IP-device and <mac address> is its MAC address (for example, AXIS 214 - 00408C7D2610).

4.2.3 Features of configuring IP devices using the Web interface

On the page:

- Features of configuring Panasonic IP devices (i-Pro series) using the Web interface
- Features of configuring Samsung IP devices using the Web interface
- Features of configuring Mobotix IP devices using the Web interface
- Features of configuring Sony IP devices using the Web interface

Note

Details on how to configure IP devices using the Web interface are given in reference manuals to corresponding devices.

Features of configuring Panasonic IP devices (i-Pro series) using the Web interface

If a Panasonic IP device (i-Pro series) is configured to simultaneous transmission of video streams in MJPEG and MPEG-4 formats, then video stream rate in MJPEG format is limited by 5(10) fps.

Note

WV-NP1000\1004, WV-F284, WV-NP240\244, WV-NS202 and other models belong to IP devices of i-Pro series.

Features of configuring Samsung IP devices using the Web interface

An audio input gain for Samsung SNC-B2315 IP device is configured using **Setup** → **Video & Audio Configuration** → **Input Gain**. By default the **Input Gain** parameter equals 0 and audio signals are not played back by IP device. To play back audio signals select the value of the **Input Gain** parameter from 1 to 10 depending on the required audio input gain.

Samsung SNC-M300P IP device supports dual stream mode of video compression in MJPEG and MPEG-4 formats. If the value 25 fps is selected for the frame rate of MJPEG video stream (the **Frame Rate** parameter), then the range of

values of analog parameter for MPEG-4 format is restricted by 3fps. To extend the given rate the value less than 25fps for the **Frame Rate** parameter of MJPEG-video stream is to be selected.

Features of configuring Mobotix IP devices using the Web interface

Resolution of Mobotix MX-Q22M-Sec-D11 panoramic camera is determined by selected mode of video displaying (**Display Mode**) in the **Setup Menu** tab.

Display Mode	Resolution
Full Image	2048*1536
Normal	1456*1088
Surround	1456*1088
Panorama	2048*768
Double Panorama	1456*1088
Focus Panorama	1456*1088

Note

In the **Double Panorama** mode the screen is divided by horizontal line into equal areas, each of which displays panoramic video.

As a Mobotix MX-Q22M-Sec-D11 camera is a panoramic one, proportions are distorted in Axxon PSIM™. The **Normal** mode is recommended to be set for proper video displaying.

Features of configuring Sony IP devices using the Web interface

The **Light Funnel** function is used for sensitivity enhancement of Sony SNC-CM120 IP device. The settings are accessed in **Setting -> Camera -> Sense up** tab.

Enabling the **Light Funnel** option leads to changing the range of values of the following settings in *Axxon PSIM™*:

1. Videostream rate;
2. Video resolution (in MJPEG format).

Configuring *Axxon PSIM* using the **Light Funnel** option:

Setting in Axxon PSIM™	Implementation of a setting in Axxon PSIM™	Range of values	
		The Light Funnel is disabled	The Light Funnel is enabled
Videostream rate	The Speed slider on the settings panel of the Video capture device object	Not more than 10fps	Up to 30 fps

Video resolution (in MJPEG format)	The Resolution dropdown list on the settings panel of the Camera object	Full (1280*960) High (960*720) Standard (640*480)	Standard (640*480)
------------------------------------	---	---	--------------------

Example
 If Full resolution is set with enabled **Light Funnel** option, then video is displayed in standard resolution.

4.3 Appendix 3. Technical specifications of video capture cards

On the page:

- Technical specifications of FS-5, FS-6, FS-16 and FS-8 video capture cards
- Technical specifications of WS-6, WS-7, SC390N16 (WS16) and WS-17 video capture cards
- Technical specifications of SC300D16 (FX8), SC200Q4 (FS15), SC300Q16 (FX4), SC310N16 (FX16), SC330Q16 and SC330D16 video capture cards
- Technical specifications of SC200Q4 Low profile (FS115), FX2, SL16-200 (FX116), FX416 and SC230N4

- video capture cards
- Technical specifications of SC3B0N16 (WS216), SC510N4 (FX HD4) and MS416 video capture cards
 - Technical specifications of DS-4016HCI(R) and SC590N4 video capture card

4.3.1 Technical specifications of FS-5, FS-6, FS-16 and FS-8 video capture cards

Parameters	FS-5	FS-6	FS-16	FS-8
PCI bus, bit / MHz	32 / 33, using PCI-66/X	32 / 33, using PCI-66/X	PCI E 1x	32 / 33, using PCI-66/X
Supply voltage, V	3.3 and 5	3.3 and 5	3.3	3.3 and 5
Power consumption, W	2	5	5	9
Video inputs, V / Ohm	1 / 75	1 / 75	1 / 75	1 / 75
Video output, V / Ohm	1 / 75	1 / 75	1 / 75	1 / 75
Number of video inputs	16	16	16	16
Hardware compression	no	no	no	no
Analog video out	1 (optional)	1 (optional)	1 (optional)	1 (built-in)
Signal type	CCIR PAL, NTSC	CCIR PAL, NTSC	CCIR PAL, NTSC	CCIR PAL, NTSC

Parameters	FS-5		FS-6		FS-16		FS-8	
	PAL	NTSC	PAL	NTSC	PAL	NTSC	PAL	NTSC
Resolution, pixels	352*288	320*240	352*288	320*240	352*288	320*240	352*288	320*240
		640*240		640*240		640*240		640*240
	704*288	640*480	704*288	640*480	704*288	640*480	704*288	640*480
	704*576		704*576		704*576		704*576	
Resolution, TV lines (b/w, color)	480		480		480		480	
Color palette	16 mln colors, 256 shades of gray		16 mln colors, 256 shades of gray		16 mln colors, 256 shades of gray		16 mln colors, 256 shades of gray	
Number of multiplexed video inputs	16		16		16		16	
Number of non-multiplexed (live) video inputs	1		4		4		8	
Video input rate for each non-multiplexed channel, fps, PAL (NTSC)	25 (30)		25 (30)		25 (30)		25 (30)	
Total video input rate for all multiplexed channels, fps, PAL	16 (704x288, 352x288)		64 (704x288, 352x288)		64 (704x288, 352x288)		128 (704x288, 352x288)	
	12 (704x576)		48 (704x576)		48 (704x576)		96 (704x576)	
Total video input rate for all multiplexed channels, fps, NTSC	20 (640x240, 320x240)		80 (640x240, 320x240)		80 (640x240, 320x240)		160 (640x240, 320x240)	
	15 (640x480)		60 (640x480)		60 (640x480)		120 (640x480)	
Total video input rate for all non-multiplexed channels, fps, PAL (NTSC)	25 (30)		100 (120)		100 (120)		200 (240)	

Parameters	FS-5	FS-6	FS-16	FS-8
Galvanic isolation of sensor lines	4(16), 2000 V	4 (16), 2000 V	4 (16), 2000 V	4 (16), 2000 V
Galvanic isolation of control outputs	4, 24 V, 30 mA	4, 24 V, 30 mA	4, 24 V, 30 mA	4, 24 V, 30 mA
Number of audio input/output channels	2 x RCA/ -	8 x RCA/ -	8 x RCA/ -	16 x RCA/ -
Audio digitizing frequency, kHz	8, 16, 32	8, 16, 32	8, 16, 32	8, 16, 32
Watchdog, hardware control of OS hanging-up	yes	yes	yes	yes
Digital-analog conversion, bit	9	9	9	9

4.3.2 Technical specifications of WS-6, WS-7, SC390N16 (WS16) and WS-17 video capture cards

Parameters	WS-6	WS-7	SC390N16 (WS16)*	WS-17
PCI bus, bit / MHz	32 / 33, using PCI-66/X	32 / 66(33)	1x	1x
Supply voltage, V	3,3 and 5	3,3	-	3,3
Power consumption, W	4	8	3,3	8
Video inputs, V / Ohm	1 / 75	1 / 75	1 / 75	1 / 75
Video output, V / Ohm	no	no	no	no

Parameters	WS-6		WS-7		SC390N16 (WS16)*		WS-17	
Number of video inputs	4		4		16		4	
Hardware compression	yes		yes		yes		yes	
Analog video out	no		no		no		no	
Signal type	PAL, NTSC		PAL, NTSC		PAL, NTSC		PAL, NTSC	
Resolution, pixels	PAL	NTSC	PAL	NTSC	PAL	NTSC	PAL	NTSC
	704*544	640*480	704*288 704*544	640*240 640*480	352*288 704*288 704*576	352*240 704*240 704*480	352*288 704*288 704*544	320*240 640*240 640*480
Resolution, TV lines (b/w, color)	500 (500)		500 (500)		625 (PAL)/ 525(NTSC)		500 (500)	
Color palette	16 mln colors, 256 shades of gray		16 mln colors, 256 shades of gray		16 mln colors, 256 shades of gray		16 mln colors, 256 shades of gray	
Number of multiplexed video inputs	-		-		-		-	
Number of non-multiplexed (live) video inputs	4		4		16		4	
Video input rate for each non-multiplexed channel, fps, PAL (NTSC)	25 (30)		25 (30)		25 (30)		25 (30)	
Total video input rate for all multiplexed channels, fps, PAL	-		-		-		-	

Parameters	WS-6	WS-7	SC390N16 (WS16)*	WS-17
Total video input rate for all multiplexed channels, fps, NTSC	-	-	-	-
Total video input rate for all non-multiplexed channels, fps, PAL (NTSC)	100 (120)	100 (120)	400(480)	100 (120)
Galvanic isolation of sensor lines	no	no	no	no
Galvanic isolation of control outputs	no	no	no	no
Number of audio input/output channels	8 x RCA/ -	8 x RCA/ -	16 x RCA/ -	8 x RCA/ -
Audio digitizing frequency, kHz	16	8, 16	8	8,16
Watchdog, hardware control of OS hanging-up	no	no	no	no
Digital-analog conversion, bit	9	9	10	9

Note

Resolutions supported by WS16 video capture card are given in the table for archive recording and for displaying video on the Client. On the Server video is displayed only with 352x288 (PAL) / 352x240 (NTSC) resolution

4.3.3 Technical specifications of SC300D16 (FX8), SC200Q4 (FS15), SC300Q16 (FX4), SC310N16 (FX16), SC330Q16 and SC330D16 video capture cards

Parameters	SC300D16 (FX8)	SC200Q4 (FS15)	SC300Q16 (FX4)	SC310N16 (FX16)	SC330Q16	SC330D16

Size (mm x mm)	132,22 x 80		120.55 × 85		132,22 x 80		179.97 × 106.65		132,22 x 80		132,22 x 80	
Minimal requirements to the input/output bus, standard	PCI-E x 1		PCI (33MHZ)		PCI-E x 1		PCI-E×4 (33MHZ)		PCI-E x 1		PCI-E x 1	
ADC (bit)	10		10		10		10		10		10	
Number of video inputs	16 x BNC		4 × BNC		16 x BNC		16 x BNC		16 x BNC		16 x BNC	
Hardware compression	no		no		no		no		no		no	
Analog video out	no		no		no		no		no		no	
Power consumption, W	4		0,5		4		5,5		4		4	
Video inputs, V / Ohm	1/75		1/75		1/75		1/75		1/75		1/75	
Video output, V / Ohm	1/75		1/75		1/75		1/75		1/75		1/75	
Audio input, V/ kOhm	1/40		1/40		1/40		3,5/10		1/40		1/40	
Signal type	PAL, NTSC		PAL, NTSC		PAL, NTSC		PAL, NTSC		PAL, NTSC		PAL, NTSC	
Resolution, pixels	PAL	NTS C	PAL	NTS C	PAL	NTS C	PAL	NTS C	PAL	NTS C	PAL	NTS C
	352* 288	320* 240	352* 288	320* 240	352* 288	320* 240	352* 288	320* 240	352* 288	320* 240	352* 288	320* 240
	704* 288	640* 240	704* 288	640* 240	704* 288	640* 240	704* 288	640* 240	704* 288	640* 240	704* 288	640* 240
	704* 576	640* 480	704* 576	640* 480	704* 576	640* 480	704* 576	640* 480	704* 576	640* 480	704* 576	640* 480

Maximum resolution, TV lines (b/w, color)	576 (PAL) / 480 (NTSC)	576 (PAL) / 480 (NTSC)	470	625 (PAL) / 525 (NTSC)	600	600
Color palette	16 mln colors, 256 shades of gray	16 mln colors, 256 shades of gray	16 mln colors, 256 shades of gray	16 mln colors, 256 shades of gray	16 mln colors, 256 shades of gray	16 mln colors, 256 shades of gray
Number of multiplexed video inputs	16	4	16	-	16	16
Number of non-multiplexed (live) video inputs	8	1	4	16	4	8
Video input rate for each non-multiplexed channel, fps, PAL (NTSC)	25 (30)	25 (30)	25 (30)	25 (30)	25 (30)	25 (30)
Total video input rate for all multiplexed channels, fps, PAL	128 (704x288, 352x288) 128 (704x576)	16 (704x288, 352x288) 16 (704x576)	64 (704x288, 352x288) 64 (704x576)	-	64 (704x288, 352x288) 64 (704x576)	128 (704x288, 352x288) 128 (704x576)
Total video input rate for all multiplexed channels, fps, NTSC	160(640x240, 320x240) 160(640x480)	20(640x240, 320x240) 20(640x480)	80(640x240,320x240) 80(640x480)	-	80(640x240,320x240) 80(640x480)	160(640x240, 320x240) 160(640x480)
Total video input rate for all non-multiplexed channels, fps, PAL (NTSC)	200 (240)	25 (30)	100 (120)	400(480)	100 (120)	200 (240)

Number of audio input/output channels	8 x RCA/ -	1 x TRS/ -	4 x RCA/ -	16 x RCA/ -	4 x RCA/ -	8 x RCA/ -
Audio digitizing frequency, kHz	8, 16, 24, 32, 40, 48	8, 16, 24, 32, 40, 48	8, 16, 24, 32, 40, 48	8, 16, 24, 40, 48	8, 16, 24, 32, 40, 48	8, 16, 24, 32, 40, 48
Galvanic isolation of sensor lines	4	not integrated	4	4	4	4
Control outputs, open collector	4	not integrated	4	4	4	4
Watchdog, hardware control of OS hanging-up	yes	yes	yes	yes	yes	yes
Peak temperature of card	50 ⁰ C	40 ⁰ C	40 ⁰ C	65 ⁰ C	40 ⁰ C	50 ⁰ C
Supported OS	All OS supported by the Axxon PSIM™ system	All OS supported by the Axxon PSIM™ system	All OS supported by the Axxon PSIM™ system	All OS supported by the Axxon PSIM™ system	All OS supported by the Axxon PSIM™ system	All OS supported by the Axxon PSIM™ system

4.3.4 Technical specifications of SC200Q4 Low profile (FS115), FX2, SL16-200 (FX116), FX416 and **SC230N4** video capture cards

Parameters	SC200Q4 Low profile (FS115)	FX2	SL16-200 (FX116)	FX416	SC230N4
Minimal requirements to the input/output bus, standard	PCI	PCI-E x 1	PCI-E x 1	PCI-Ex4	PCI
ADC (bit)	10	9	10	10	10

Parameters	SC200Q4 Low profile (FS115)		FX2		SL16-200 (FX116)		FX416		SC230N4	
Number of video inputs	4 x BNC		8 x BNC		16 x BNC		16 x BNC		4 x BNC	
Hardware compression	no		no		no		no		no	
Analog video out	no		1 (optionally)		no		no		no	
Power consumption, W	0,5		3		1,5		1,8		4	
Video inputs, V / Ohm	1/75		1/75		1/75		1/75		1/75	
Video outputs, V / Ohm	1/75		1/75		1/75		1/75		1/75	
Audio input, V/ kOhm	1/40		1,4 / 5		1/10		1/10		1/40	
Signal type	PAL, NTSC		PAL, NTSC		PAL, NTSC		PAL, NTSC		PAL, NTSC	
Resolution, pixels	PAL	NTSC	PAL	NTSC	PAL	NTSC	PAL	NTSC	PAL	NTSC
	352*288	320*240	352*288	320*240	352*288	320*240	352*288	352*240	352*288	320*240
	704*288	640*240	704*288	640*240	704*288	640*240	704*288	704*240	704*288	640*240
	704*576	640*480	704*576	640*480	704*576	640*480	704*576	704*480	704*576	640*480
Maximum resolution, TV lines (b/w, color)	576 (PAL) / 480 (NTSC)		480		420		625 (PAL) / 525 (NTSC)		576 (PAL) / 480 (NTSC)	
Color palette	16 mln colors, 256 shades of gray		16 mln colors, 256 shades of gray		16 mln colors, 256 shades of gray		16 mln colors, 256 shades of gray		16 mln colors, 256 shades of gray	

Parameters	SC200Q4 Low profile (FS115)	FX2	SL16-200 (FX116)	FX416	SC230N4
Number of multiplexed video inputs	4	8	16	-	-
Number of non-multiplexed (live) video inputs	1	2	8	16	4
Video input rate for each non-multiplexed channel, fps, PAL (NTSC)	25 (30)	25 (30)	25 (30)	25 (30)	25(30)
Total video input rate for all multiplexed channels, fps, PAL	16 (704x288, 352x288) 16 (704x576)	32 (704x288, 352x288) 24 (704x576)	128 (704x576)	-	-
Total video input rate for all multiplexed channels, fps, NTSC	20(640x240, 320x240) 20(640x480)	40(640x240,320x240) 30(640x480)	160(640x480)	-	-
Total video input rate for all non-multiplexed channels, fps, PAL (NTSC)	25 (30)	50 (60)	200 (240)	400 (480)	100 (120)
Number of audio inputs/outputs channels	1 x RCA/ -	4 x RCA/ -	16 x RCA/ -	16 x RCA/ -	4 x RCA / -
Audio digitizing frequency, kHz	8, 16, 24, 32, 40, 48	8, 16, 32	8, 16	8, 16	8, 16, 24, 32, 40, 48
Galvanic isolation of sensor lines	4	4 (16), 2000 V	not integrated	not integrated	4

Parameters	SC200Q4 Low profile (FS115)	FX2	SL16-200 (FX116)	FX416	SC230N4
Control outputs, open collector	4	4, 24 V, 30 mA	not integrated	not integrated	4
Watchdog, hardware control of OS hanging-up	yes	yes	yes	yes	yes
Supported OS	All OS supported by the Axxon PSIM™ system	All OS supported by the Axxon PSIM™ system	All OS supported by the Axxon PSIM™ system	All OS supported by the Axxon PSIM™ system	All OS supported by the Axxon PSIM™ system

4.3.5 Technical specifications of SC3B0N16 (WS216), SC510N4 (FX HD4) and MS416 video capture cards

Parameters	SC3B0N16 (WS216)*	SC510N4 (FX HD4)	MS416
Minimal requirements to the input/output bus, standard	PCI-E x 1	PCI-E×4	PCI-Ex4
ADC (bit)	10	-	10
Number of video inputs	16	4	16 x BNC
Hardware compression	yes	no	no
Analog video out	no	no	no
Power consumption, W	3,3	3,3	1,8
Video inputs, V / Ohm	1/75	-	1/75
Video outputs, V / Ohm	-	-	1/75
Signal type	PAL, NTSC	-	PAL, NTSC

Parameters	SC3B0N16 (WS216)*		SC510N4 (FX HD4)	MS416	
	PAL	NTSC		PAL	NTSC
Resolution, pixels	352*28 8	352*240	1920*1080, 1280*720 - noninterlaced scan 1280*720 - interlaced scan	352*28 8	320*240
	704*28 8	704*240		704*28 8	640*240
	704*57 6	704*480		704*57 6	640*480
Maximum resolution, TV lines (b/w, color)	576 (PAL) / 480 (NTSC)		-	625 (PAL) / 525 (NTSC)	
Color palette	16 mln colors, 256 shades of gray		16 mln colors, 256 shades of gray	16 mln colors, 256 shades of gray	
Number of multiplexed video inputs	-		-	-	
Number of non-multiplexed (live) video inputs	16		4	16	
Total video input rate for all non-multiplexed channels, fps, PAL (NTSC)	25 (30)		25 (1920x1080 resolution) 50 (1280x720 resolution)	25 (30)	
Total video input rate for all multiplexed channels, fps, PAL (NTSC)	-		200 (1280x720 resolution) 100 (1920x1080 resolution)	-	
Total video input rate for all non-multiplexed channels, fps, PAL (NTSC)	400 (480)		200 (1280x720 resolution) 100 (1920x1080 resolution)	400 (480)	
Number of audio inputs/ outputs channels	16 x RCA/ -		4 x HDMI/ 4 x HD SDI	32 x RCA/ -	
Audio digitizing frequency, kHz	8		32 - 48	48	

Parameters	SC3B0N16 (WS216)*	SC510N4 (FX HD4)	MS416
Galvanic isolation of sensor lines	4	not integrated	not integrated
Control outputs, open collector	4	not integrated	not integrated
Watchdog, hardware control of OS hanging-up	yes	yes	yes
Supported OS	All OS supported by the Axxon PSIM™ system	All OS supported by the Axxon PSIM™ system	All OS supported by the Axxon PSIM™ system

Note

Resolutions supported by WS26 video capture card are given in the table for archive recording and displaying video on the Client. On the Server video is displayed only with 352x288 (PAL) / 352x240 (NTSC) resolution

Note.

In order to use SC3B0N16 video capture card in Windows Server 2012 R2 enable the *Desktop Experience*. Find information on how to work with this component at [https://technet.microsoft.com/en-us/library/cc754314\(v=ws.11\).aspx](https://technet.microsoft.com/en-us/library/cc754314(v=ws.11).aspx)

4.3.6 Technical specifications of DS-4016HCI(R) and SC590N4 video capture card

Parameters	SC590N4
Minimal requirements to the input/output bus, standard	PCI Express 1x
Size (mm x mm)	189 x 90
Number of video channels	4
Video input interface	HD SDI
Maximum fps for a channel	50 fps (PAL) / 60 fps (NTSC)

Resolution at recording, pixels	1920x1080 @ 30/25/24fps 1920x1080 @ 50/60fps 1280x720 @ 30/25/24fps 1280x720 @ 50/60fps
Resolution under compression, pixels	-
Number of non-multiplexed (live) video inputs	4
Total video input rate for all non-multiplexed channels	120fps @ 1920x1080i
Color palette	16 mln colors, 256 shades of gray
Video compression format	H.264 Main Profile

Number of audio channels	4 x SDI + 2 x 3.5mm jack, while maximum number of channels (see configuration).
Audio compression format	Stereo / 16-bit / 48000Hz
Audio input interface	SDI, 3.5mm jack
Video/audio output	yes
Resolution of preview, pixels	960x540 @ 30/25/24fps 960x540 @ 50/60fps 640x360 @ 30/25/24fps 640x360 @ 50/60fps
Dual stream	yes
DI / DO (rays and relays)	16 (8 rays and 8 relays)
Watchdog, hardware control of OS hanging-up	yes

Supported OS	All OS supported by the Axxon PSIM™ system
--------------	--

Note.

Using the SC590N4 Video capture card with h.264 compression format the record to archive is performed in color mode. Black and white mode of record is not supported. Also, the card sends separate streams with different resolution for displaying and recording to the archive.

Note.

While configuring the video camera which is connected through the SC590N4 video capture card, in the *Axxon PSIM* software the frame resolution is to be set as the resolution set on the video camera. Otherwise, artefacts can appear on the video image.

Note.

In order to use SC590N4 video capture card in Windows Server 2012 R2 enable the *Desktop Experience*. Find information on how to work with this component at [https://technet.microsoft.com/en-us/library/cc754314\(v=ws.11\).aspx](https://technet.microsoft.com/en-us/library/cc754314(v=ws.11).aspx)

4.4 Appendix 4. Video capture cards pins

4.4.1 FS-5 video capture card pins

FS-5 video capture card has 3 external pins– two RCA pins and a D-SUB-25 pin. Video connection is performed to the D-SUB-25 pin with the help of D-SUB-25/BNC stub. Simultaneous connection of up to 16 cameras is possible. Sound connection is performed with the help of RCA pins (two sound sources are maximum possible). Analog output card is connected to J2, J7, J8 pins. The *Watchdog* cable is connected to the J1 pin. The J9 pin is designed for connecting the 4/4 or 16/4 Sensor-Relay card (see [Connecting 4/4 and 16/4 Sensor-Relay cards](#)).

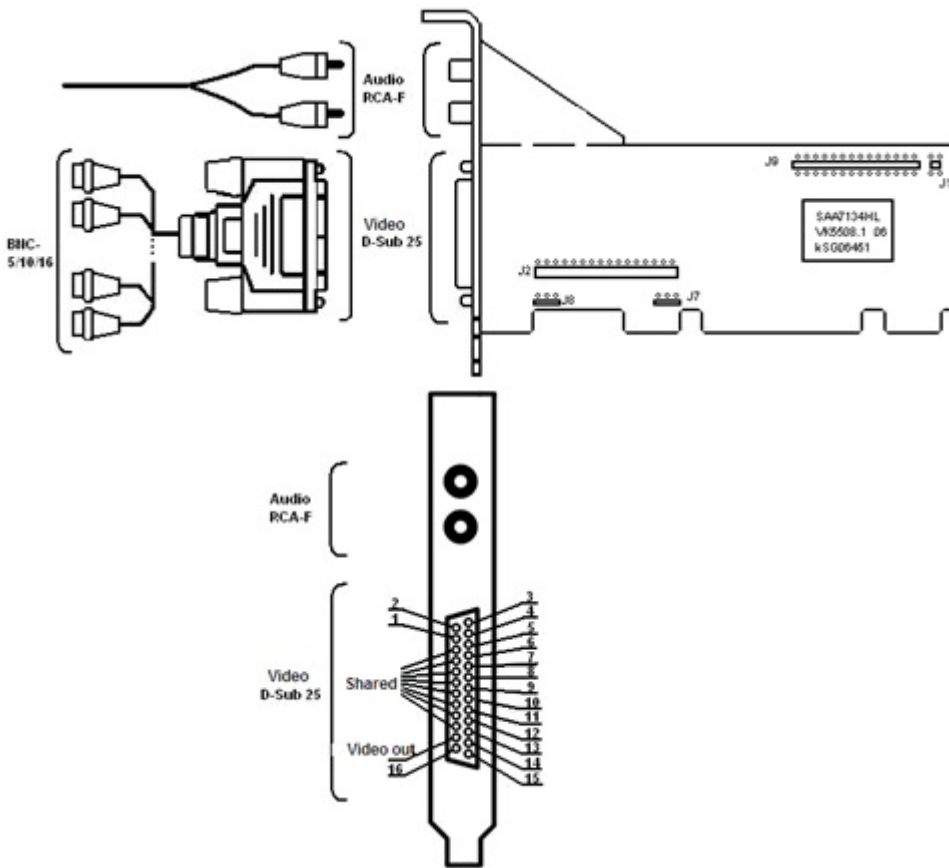

4.4.2 FS-6 video capture card pins

FS-6 video capture card has 2 external pins - D-SUB-9 and D-SUB-25. Video connection is performed with the help of D-SUB-25/BNC stub. Simultaneous connection of up to 16 cameras is possible. D-SUB-9/RCA-8 interface cable is used for connecting the audio channels (up to 8 sound sources simultaneously) to the external D-SUB-9 pin of FS-6 video capture card. Analog output card is connected to J2, J7, J8 pins. The *Watchdog* cable is connected to the J1 pin. The J9 pin is designed for connecting the 4/4 or 16/4 Sensor-Relay card (see [Connecting 4/4 and 16/4 Sensor-Relay cards](#)).

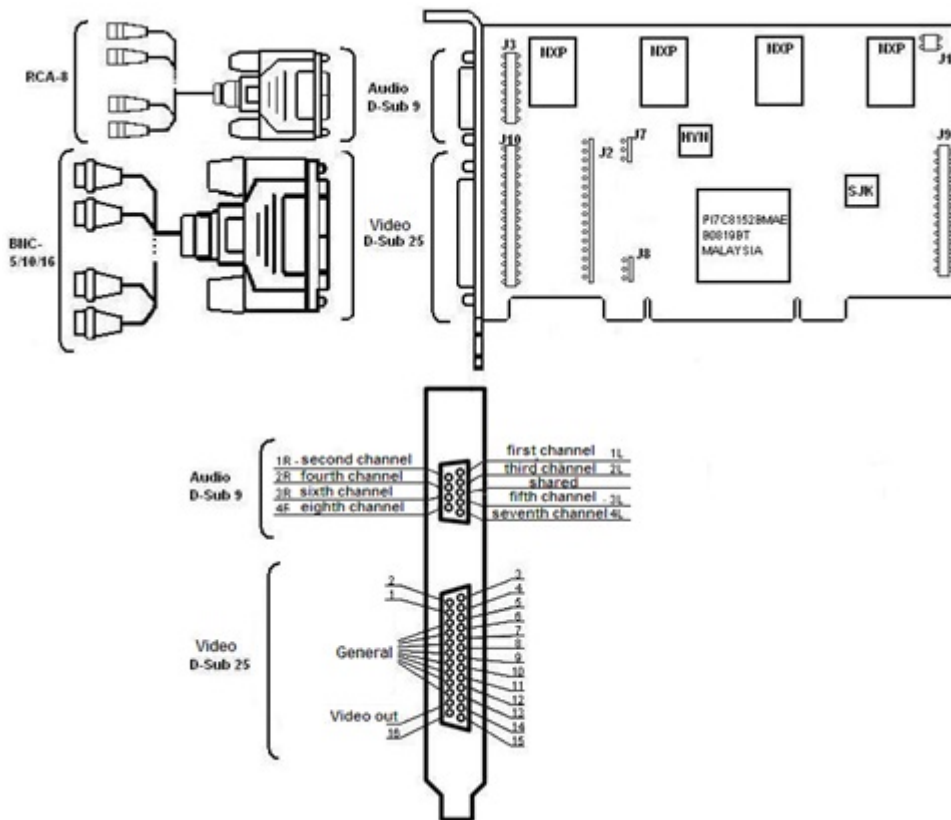

4.4.3 FS-16(Exp) video capture card pins

FS16 (Exp) video capture card has 2 external pins - D-SUB-9 and D-SUB-25. Video connection is performed with the help of D-SUB-25/BNC stub. Simultaneous reception of up to 16 video images is possible. D-SUB-9/RCA-8 interface cable is used for connecting the audio channels to the external D-SUB-9 pin of FS16 (Exp) video capture card (up to 8 sound sources simultaneously). Analog output card is connected to J2, J7, J8 pins. The *Watchdog* cable is connected to the J1 pin. The J9 pin is designed for connecting the 4/4 or 16/4 Sensor-Relay card (see [Connecting 4/4 and 16/4 Sensor-Relay cards](#)).

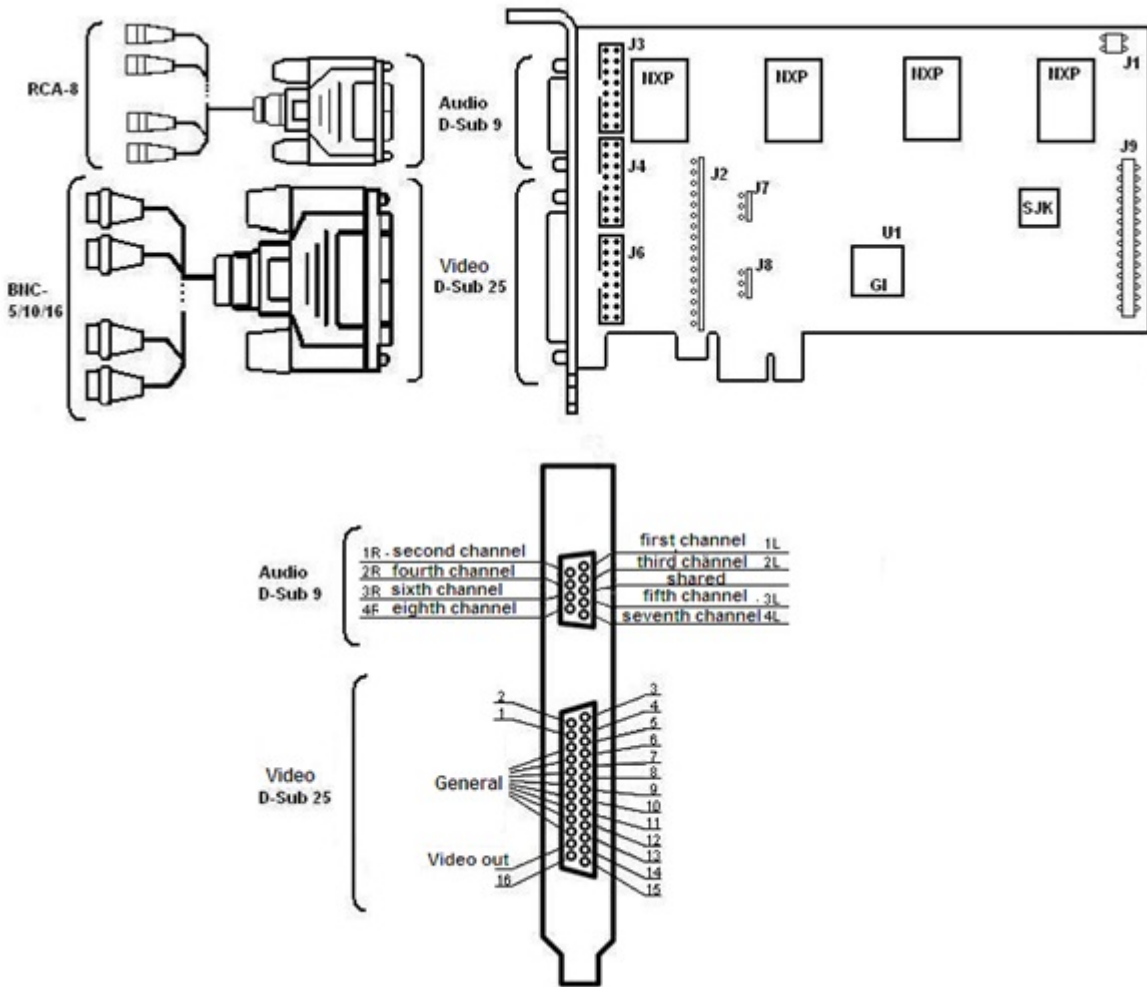

4.4.4 FS-8 video capture card pins

FS-8 video capture card has two external pins - D-SUB-9 and D-SUB-25 and one internal pin - IDC-16. Video connection is performed with the help of D-SUB-25/BNC stub via D-SUB-25 pin. Simultaneous reception of up to 16 video images is possible. D-SUB-9/RCA-8 interface cable is used for connecting the audio channels to the external D-SUB-9 pin of FS-8 video capture card (up to 8 sound sources simultaneously). IDC-16/D-SUB-9 bracket of sound extension is used (up to 8 sound sources simultaneously) to connect additional audio channels. It is connected to the internal IDC-16 pin of FS-8 video capture card. The *Watchdog* cable is connected to the J1 pin. The J9 pin is designed for connecting the 4/4 or 16/4 Sensor-Relay card (see [Connecting 4/4 and 16/4 Sensor-Relay cards](#)).

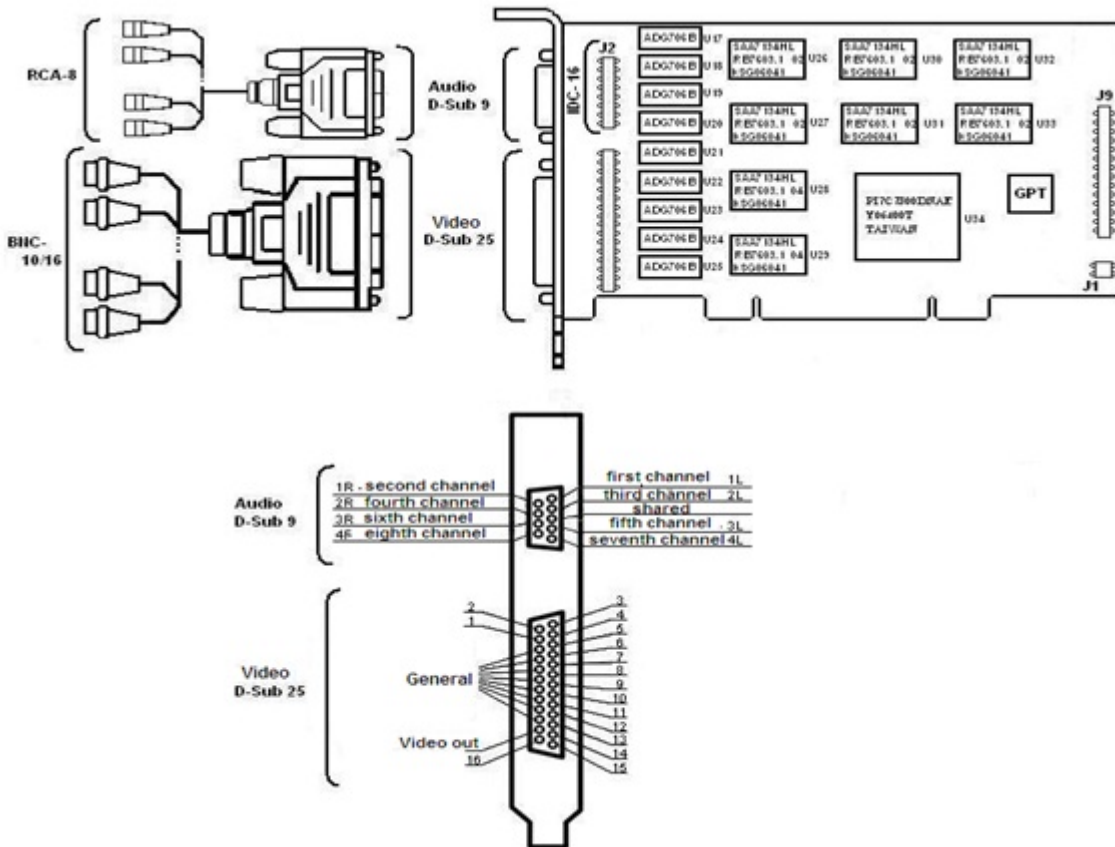

4.4.5 WS-7 video capture card pins

WS-7 video capture card has two external pins - D-SUB-9 and D-SUB-25. D-SUB-25/BNC interface cable is used for simultaneous connection of 4 cameras to the external D-SUB-25 pin of WS-7 video capture card. D-SUB-9/RCA interface cable is used for simultaneous connection of 4 audio channels to the external D-SUB-9 pin of WS-7 video capture card.

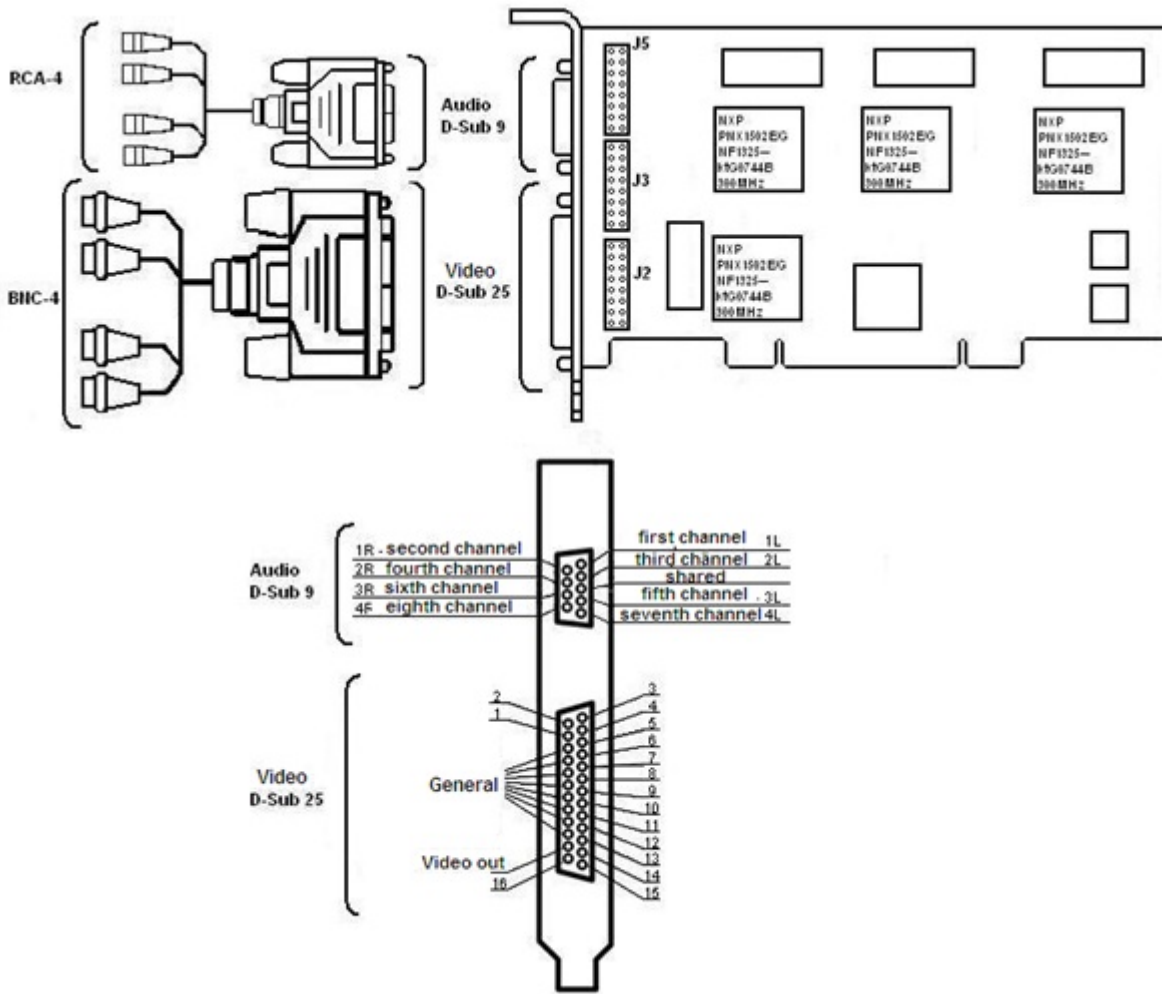

4.4.6 SC390N16 (WS-16) video capture card pins

SC390N16 (WS-16) video capture card has two external DVI-I pins. Video and audio connection is performed with the help of DVI-I/BNC and DVI-I/RCA stubs correspondingly. Simultaneous connection of up to 8 cameras and up to 8 sound sources to one external pin of SC390N16 (WS-16) video capture card is possible. The Watchdog cable is connected to the J1 pin.

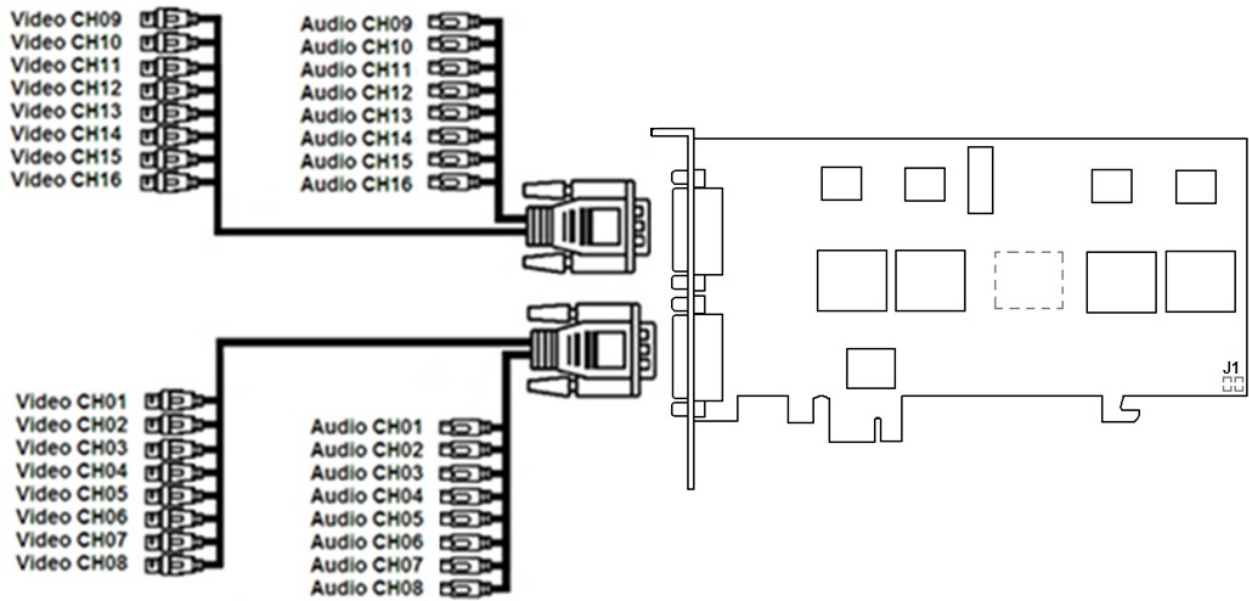

4.4.7 WS-17 video capture card pins

WS-17 video capture card has two external pins - D-SUB-9 and D-SUB-25. D-SUB-25/BNC interface cable is used for simultaneous connection up to 4 cameras to the external D-SUB-25 pin of WS-17 video capture card. D-SUB-9/RCA interface cable is used for simultaneous connection up to 4 audio channels to the external D-SUB-9 pin of WS-17 video capture card.

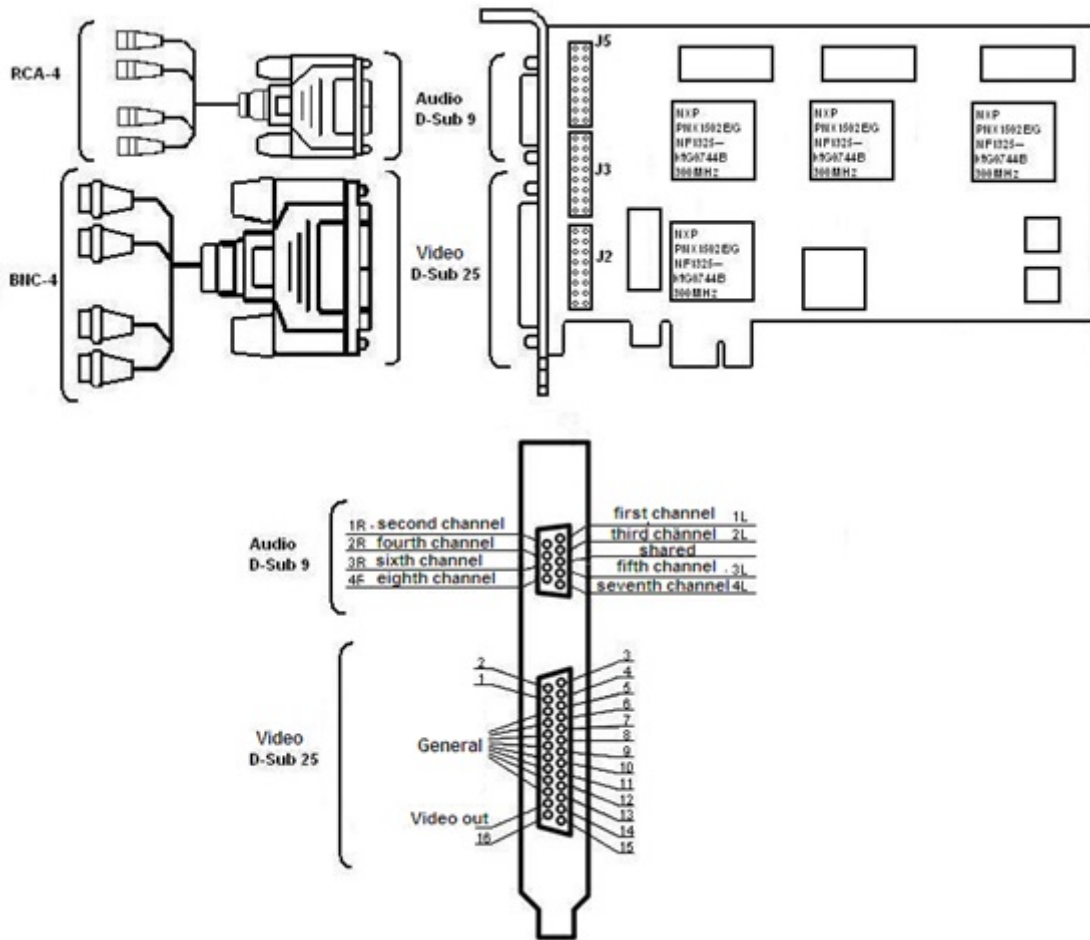

4.4.8 SC3B0N16 (WS216) video capture card pins

SC3B0N16 (WS216) video capture card has two external DVI-I pins. Video and audio connection is performed with the help of DVI-I/BNC and DVI-I/RCA stubs correspondingly. Simultaneous connection of up to 8 cameras and up to 8 sound sources to one external pin of SC3B0N16 (WS216) video capture card is possible. The Watchdog cable is connected to the J1 pin. DI/DO card is connected to the J2 pin.

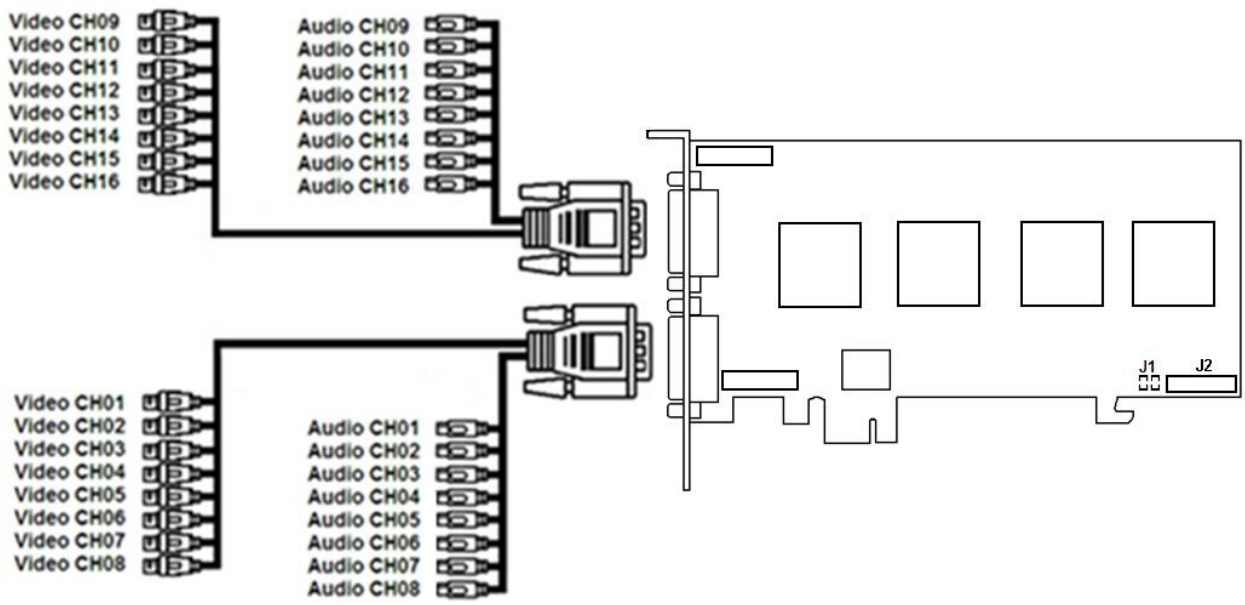

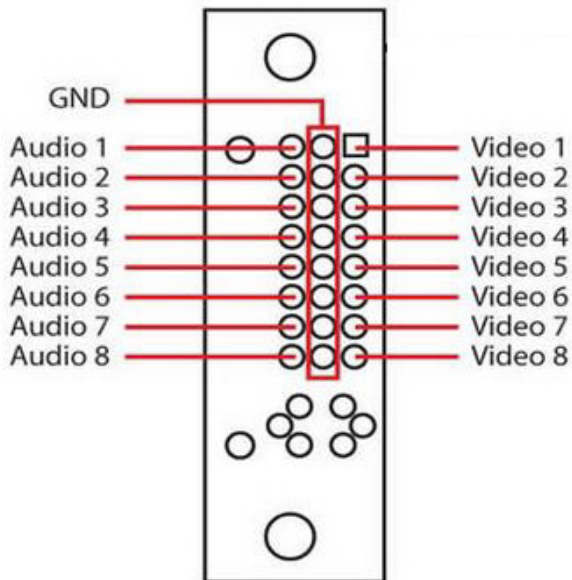
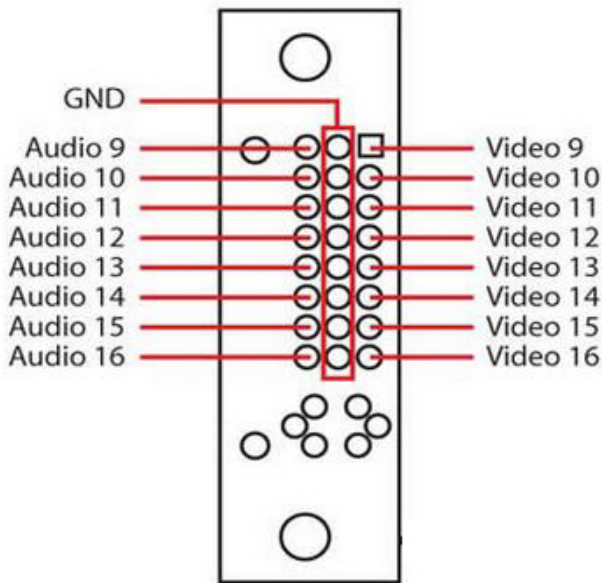

4.4.9 SC200Q4 (FS15) video capture card pins

SC200Q4 (FS15) video capture card has five external pins– one TRS (3,5 mm, *mini-jack*) pin and four BNC pins. Cameras are connected via BNC pin. Simultaneous connection of up to 4 cameras is possible. Sound is connected via TRS pin. The Watchdog cable is connected to the J1 pin.

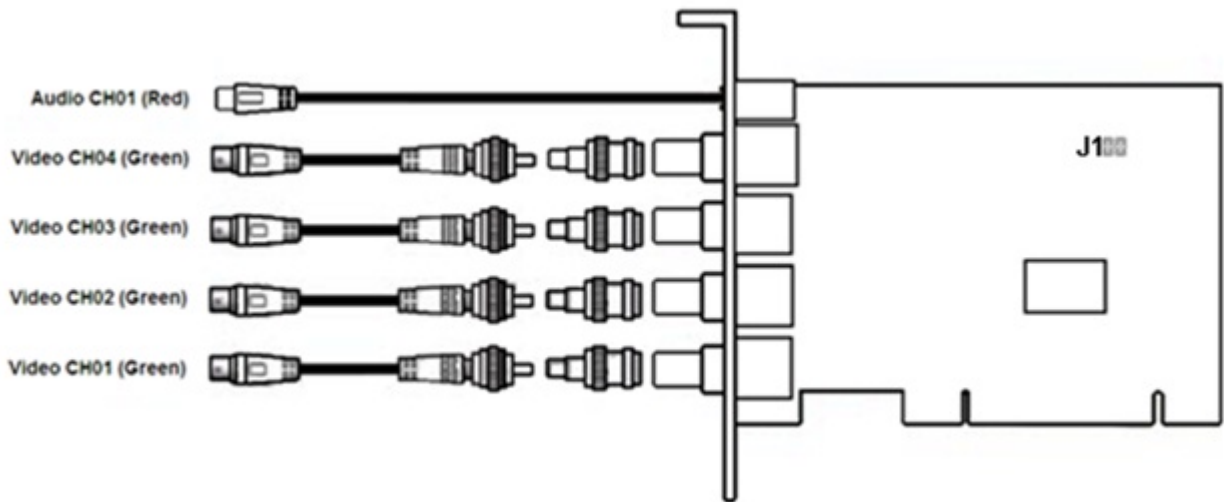

4.4.10 SC300D16 (FX8) video capture card pins

SC300D16 (FX8) video capture card has two external DVI-I (24+5) pins. Video and audio connection is performed with the help of DVI-I/BNC and DVI-I/RCA stubs correspondingly. Simultaneous connection of up to 8 cameras and up to 4 sound sources to one external pin of SC300D16 (FX8) video capture card is possible. The Watchdog cable is connected to the J1 pin. DI/DO card (low profile) is connected to the J2 pin.

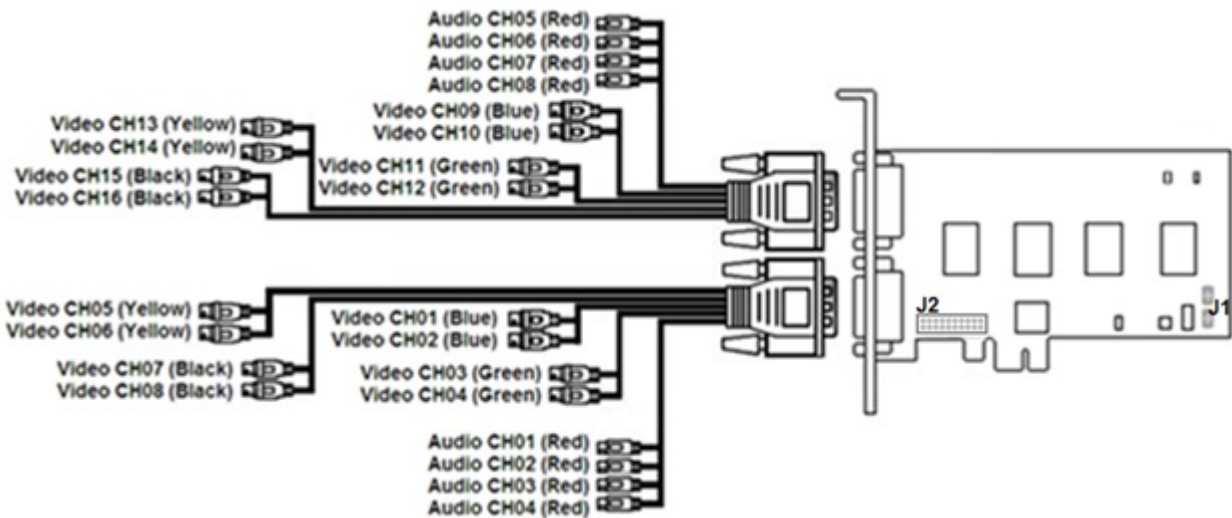

4.4.11 SC300Q16 (FX4) video capture card pins

SC300Q16 (FX4) video capture card has one external DVI-I (24+5) pin. Video and audio connection is performed with the help of DVI-I/BNC and DVI-I/RCA stubs correspondingly. Simultaneous connection of up to 16 cameras and up to 4 sound sources to one external pin of SC300Q16 (FX4) video capture card is possible. The Watchdog cable is connected to the J1 pin. DI/DO card (low profile) is connected to the J2 pin.

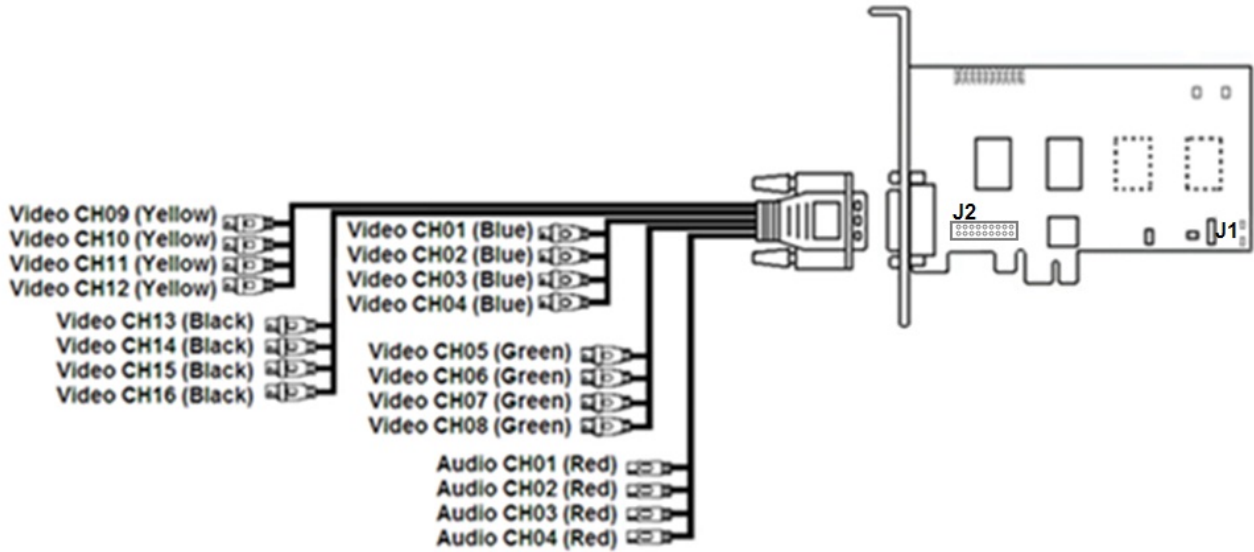

4.4.12 SC310N16 (FX16) video capture card pins

SC310N16 (FX16) video capture card has two external DVI-I (24 + 5) pins. Video and audio connection is performed with the help of DVI-I/BNC and DVI-I/RCA stubs correspondingly. Simultaneous connection of up to 8 cameras and up to 8 sound sources to one external pin of SC310N16 (FX16) video capture card is possible. The Watchdog cable is connected to the J1 pin. DI/DO card (low profile) is connected to the J2 pin.

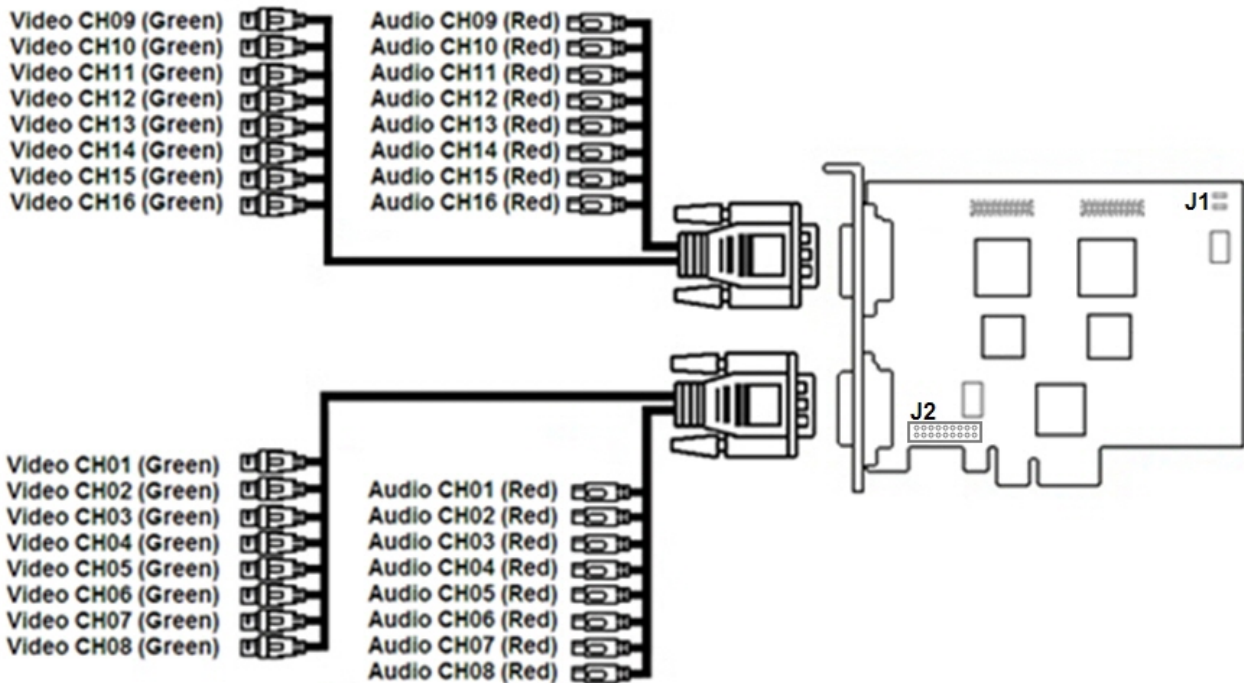

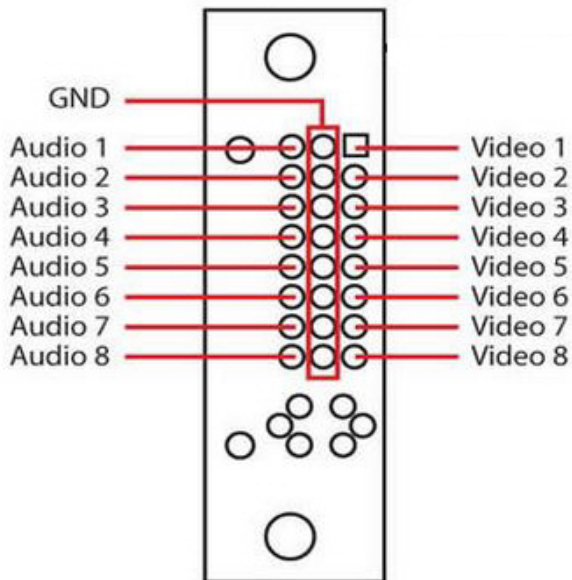
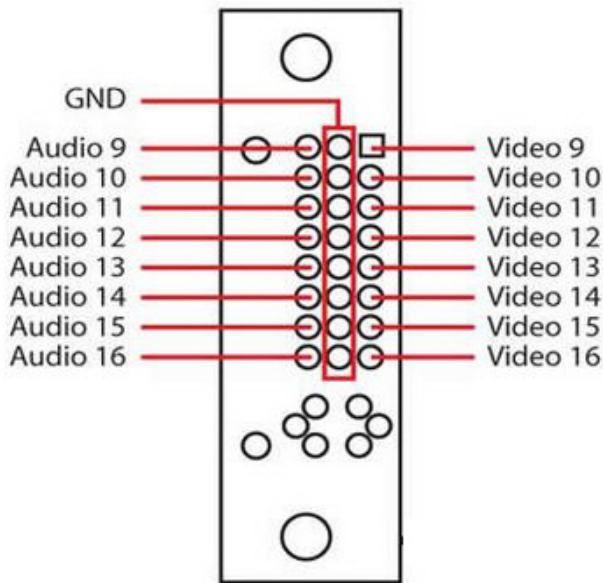

4.4.13 SC200Q4 Low profile (FS115) video capture card pins

SC200Q4 Low profile (FS115) video capture card has one external DVI-I pin. Video and audio connection is performed with the help of DVI-I/BNC and DVI-I/RCA stubs correspondingly. Simultaneous connection of up to 4 cameras and 1 sound source to one external pin of SC200Q4 Low profile (FS115) video capture card is possible. The Watchdog cable is connected to the J1 pin. DI/DO card (low profile) is connected to the J2 pin.

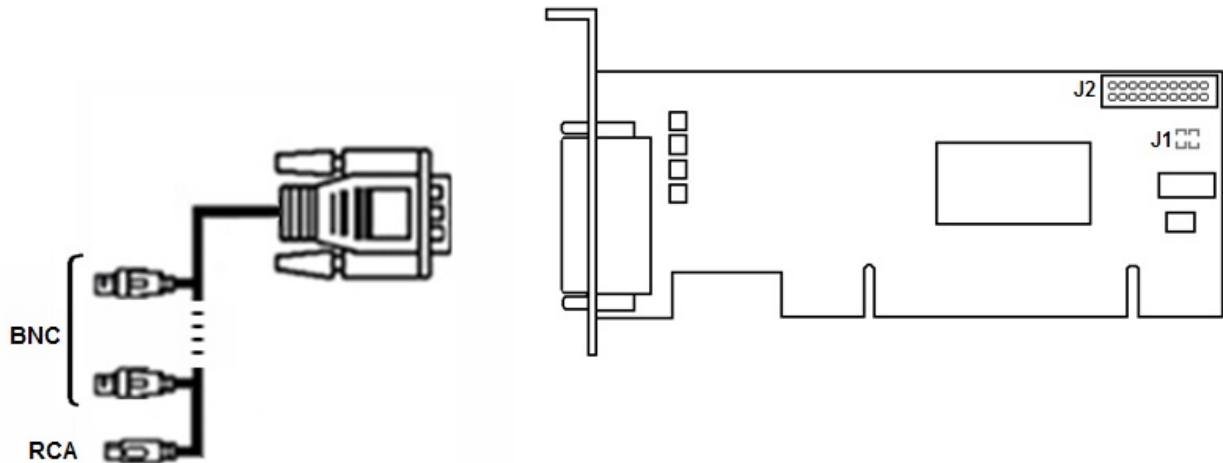

4.4.14 SL16-200 (FX116) video capture card pins

SL16-200 (FX116) video capture card has two external pins - D-SUB 25 and D-SUB 26. Simultaneous connection of up to 8 cameras and 16 sound sources to external pins of FX116 video capture card is possible. Video connection is performed with the help of D-SUB-25/BNC stub and audio connection is performed with the help of D-SUB-26/RCA stub. Watchdog cable is connected to the J1 pin.

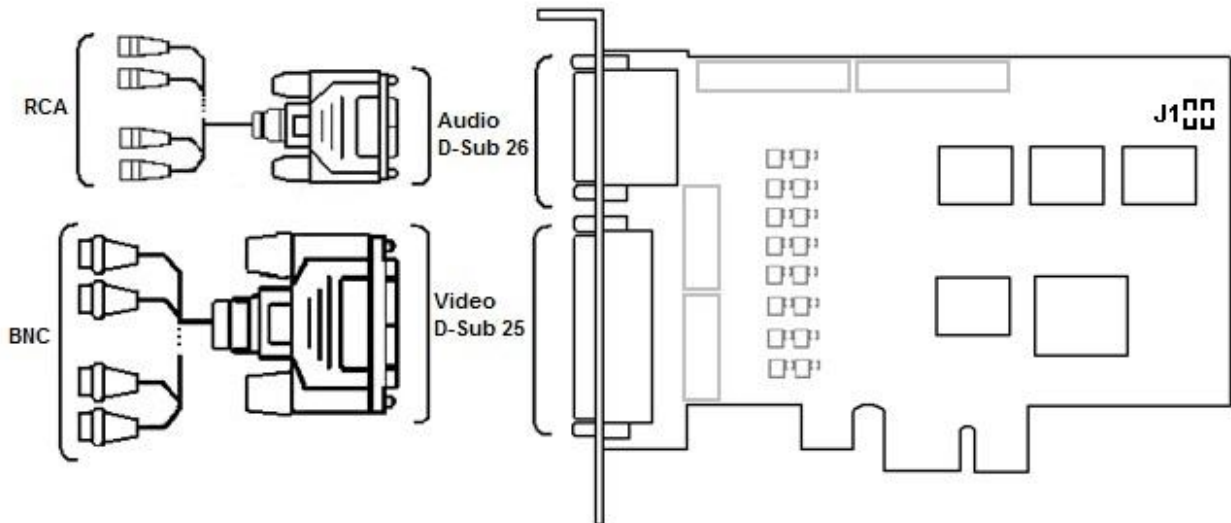

4.4.15 FX416 video capture card pins

FX416 video capture card has two external pins - D-SUB 25 and D-SUB 26. Simultaneous connection of up to 16 cameras and 16 sound sources to external pins of FX416 video capture card is possible. Video connection is performed with the help of D-SUB 25/BNC stub and audio connection is performed with the help of D-SUB 26/RCA stub.

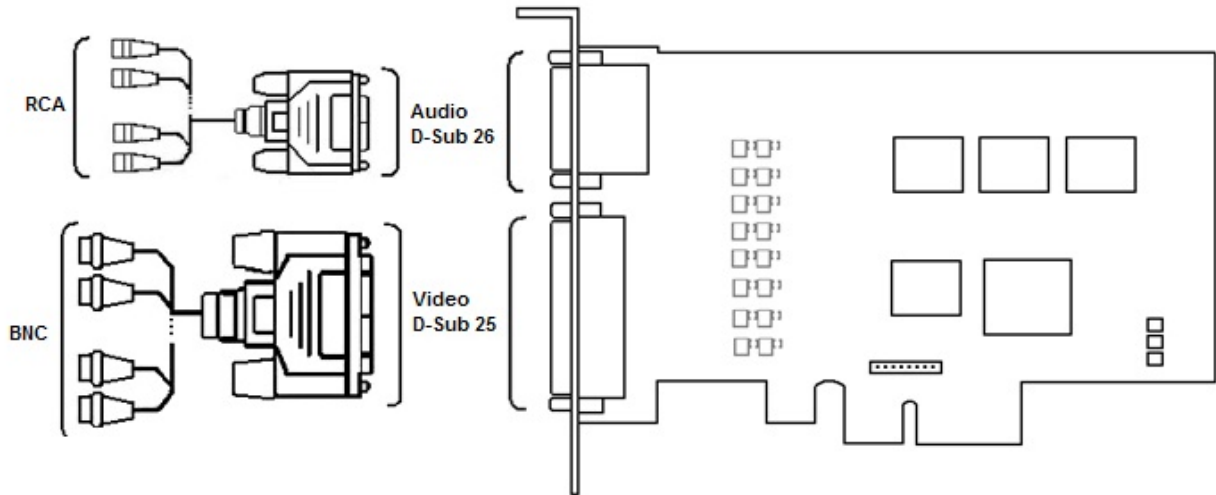

4.4.16 VRC6004 video capture card pins

VRC6004 video capture card has four external BNC pins. Cameras are connected with the help of BNC pin. Simultaneous connection of up to 4 cameras is possible. DI/DO card is connected to the J1 pin.

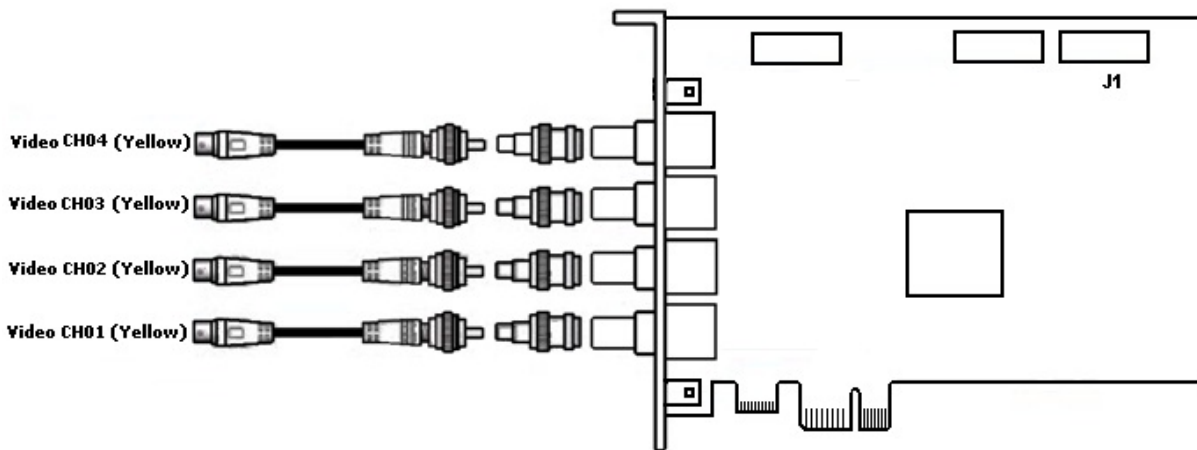

4.4.17 VRC6008 video capture card pins

VRC6008 video capture card has two external D-SUB-15 pins. D-SUB-15/BNC interface cable is used for simultaneous connection of up to 8 cameras and 8 audio channels to the external D-SUB-15 pin of VRC6008 video capture card. DI/DO card is connected to the J2 pin. Pin J1 corresponds to analog video out.

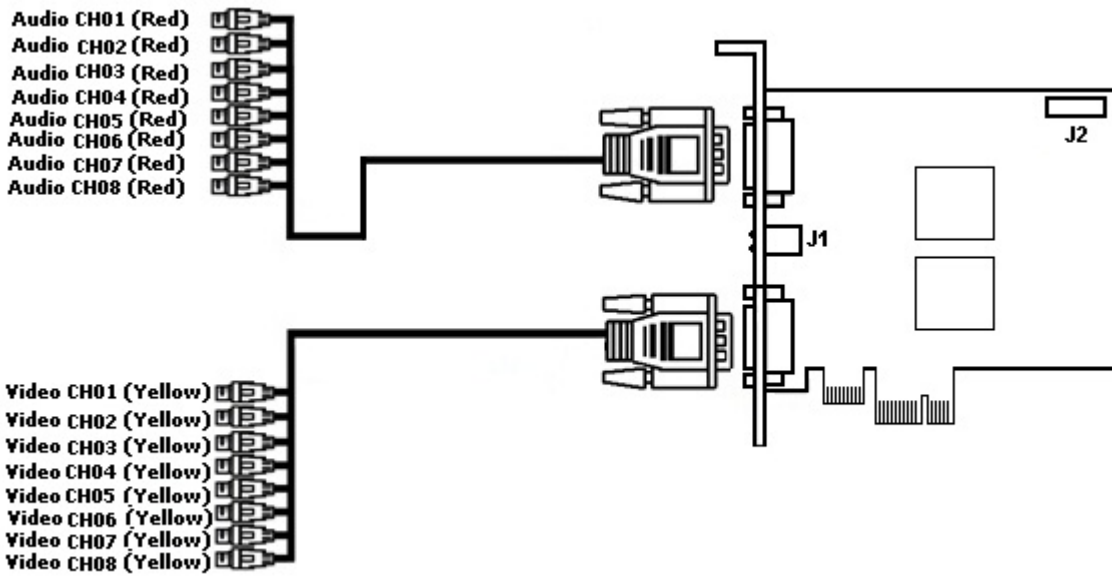

4.4.18 VRC6416 video capture card pins

VRC6416 video capture card has two external DVI pins. DVI /BNC interface cable is used for simultaneous connection of up to 16 cameras and 16 sound sources to external DVI pins of VRC6416 video capture card. DI/DO card is connected to the J1 pin.

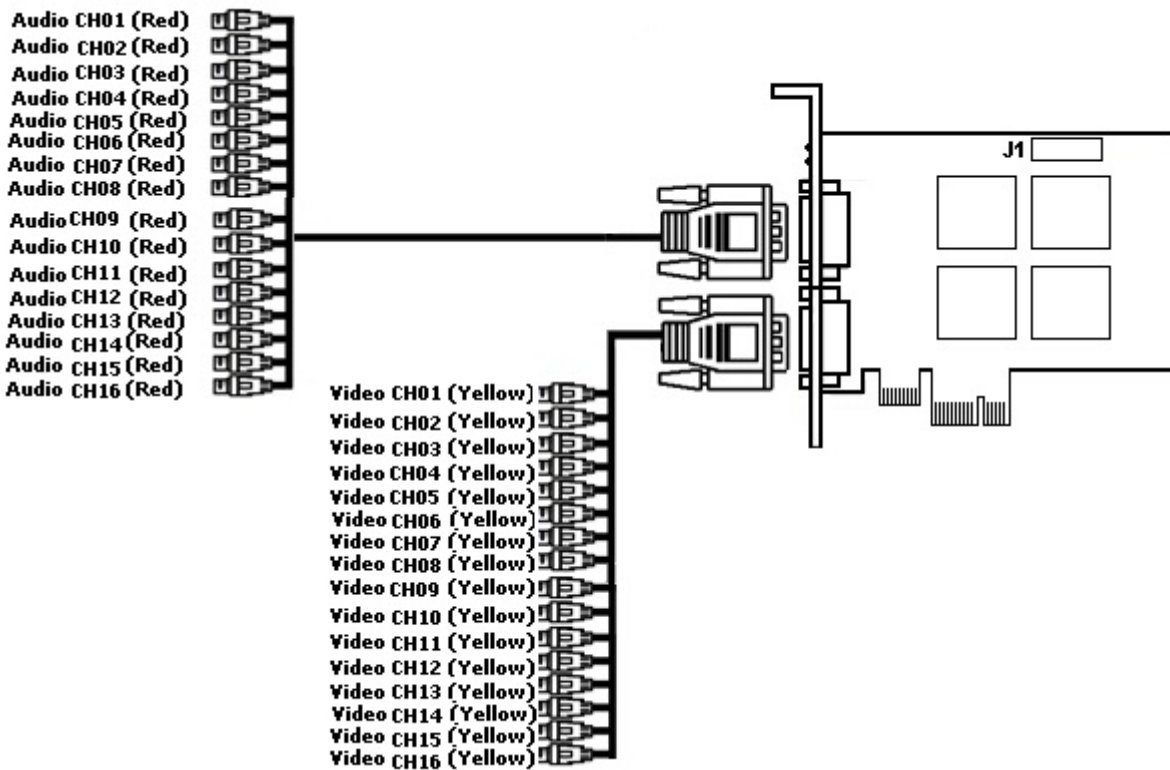

4.4.19 VRC7008L video capture card pins

VRC7008L video capture card has a DVI pin. DVI /BNC interface cable is used for simultaneous connection of up to 8 cameras and 8 sound sources to external DVI pin of VRC7008L video capture card. DI/DO card is connected to the J1 pin. J2 pin corresponds to analog video out.

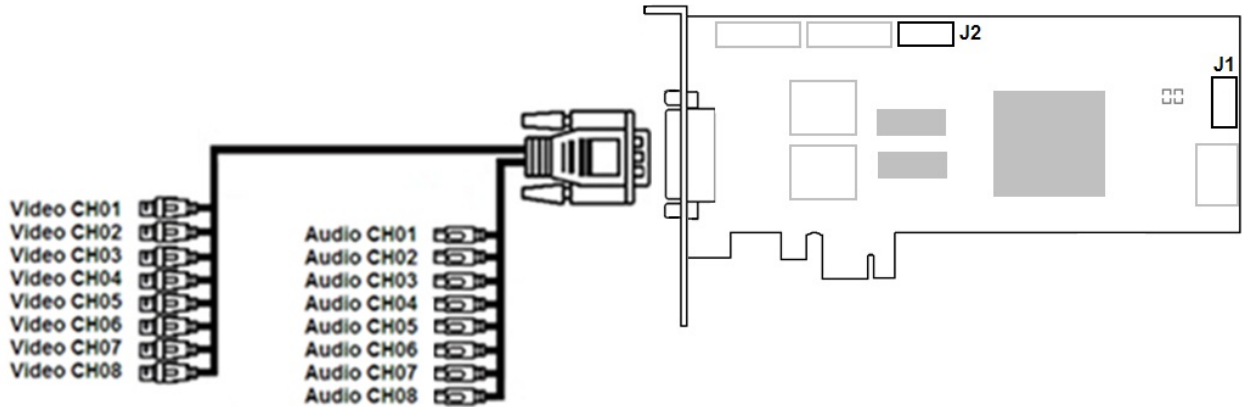

4.4.20 VRC6404 HD video capture card pins

VRC6404 HD video capture card has BNC pins through which cameras are connected. Up to 4 cameras can be connected. There is the 15-pin SATA (J4) power socket. D2 pin is used to connect DI/DO card.

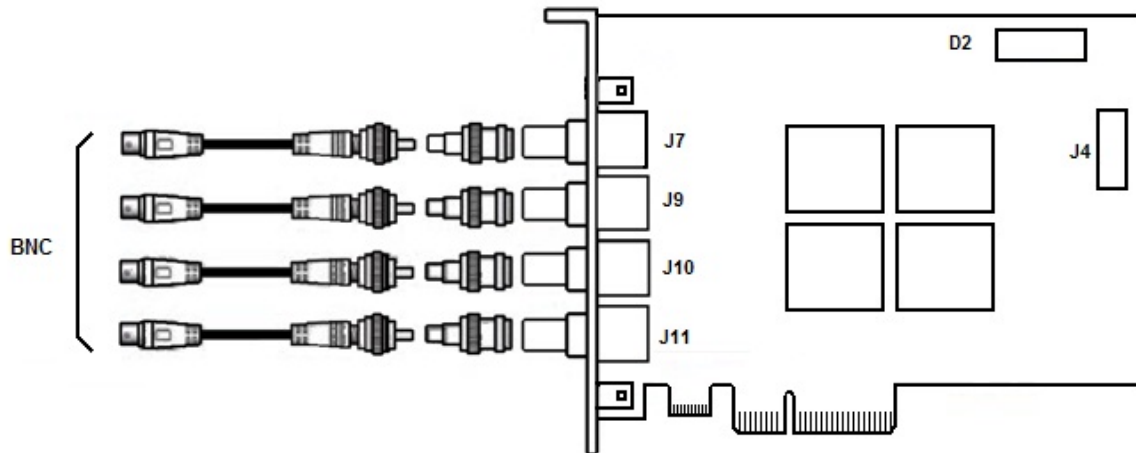

4.4.21 SC510N4 (FX HD4) video capture card pins

SC510N4 (FX HD4) video capture card has 4 external HDMI pins to connect video and audio devices. The Watchdog cable is connected to the J1 pin.

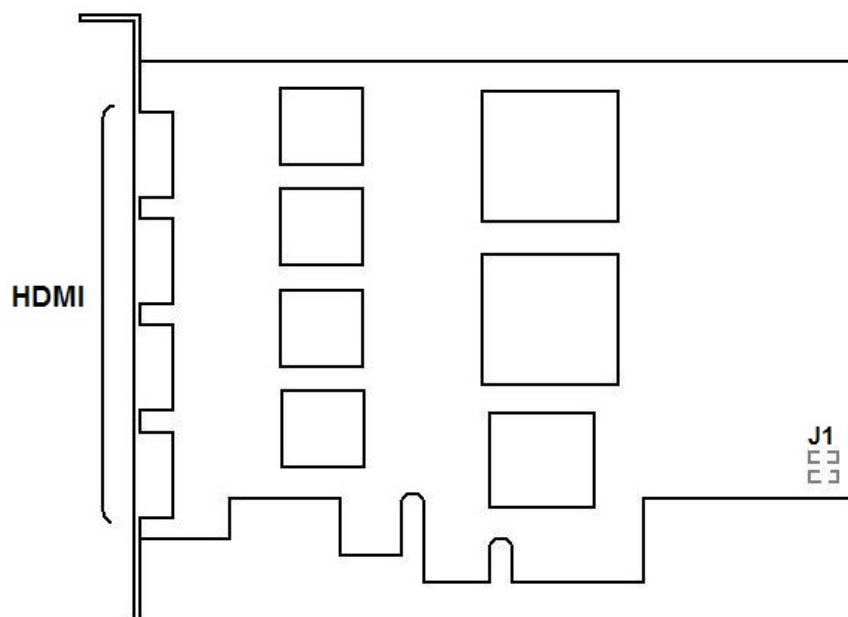

4.4.22 MS416 video capture card pins

The MS416 video capture card has two external pins: D-SUB-25 and D-SUB-26. Up to 16 video cameras and 16 audio sources can be simultaneously connected to the card's external sockets. Video connections are made using the D-SUB-25/BNC input. Audio connections use the D-SUB-26/RCA input. A J1 pin is used to connect the WatchDog hardware monitoring cable.

Slots 1-4 are used to connect additional sound cards. This card requires a separate slot in the case for installation, and it allows an additional 16 audio sources to be connected.

The following mapping exists between slot numbers and channel numbers:

- slot 1 - channels 1-8;
- slot 2 - channels 9-16;
- slot 3 - channels 17-24;
- slot 4 - channels 25-32.

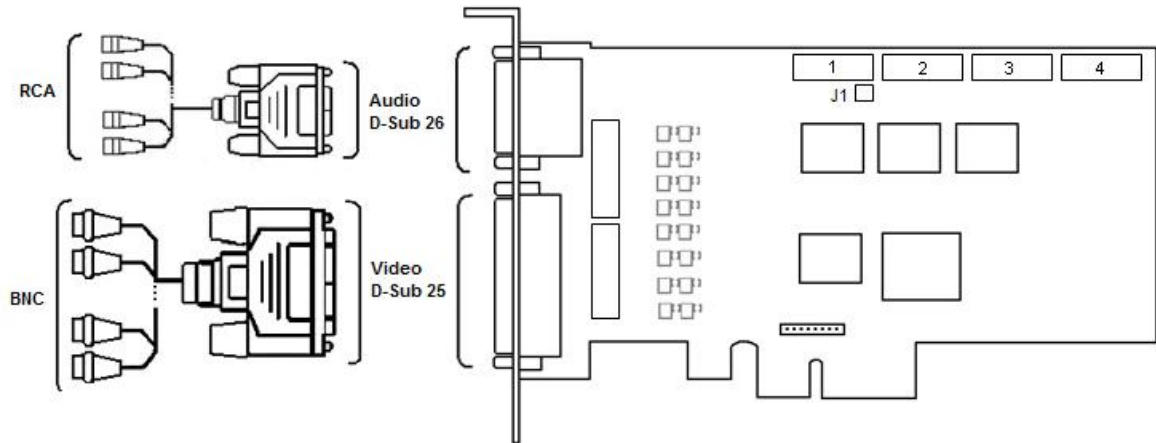

4.4.23 SC230N4 video capture card pins

The SC230N4 video capture card has one external DVI-I pin. Video and audio connection are made using DVI-I/BNC and DVI-I/RCA stubs correspondingly. Simultaneous connection of up to 4 cameras and 4 sound sources to one external pin of SC230N4 video capture card is possible. The Watchdog cable is connected to the J1 pin. DI/DO card (low profile) is connected to the J2 pin.

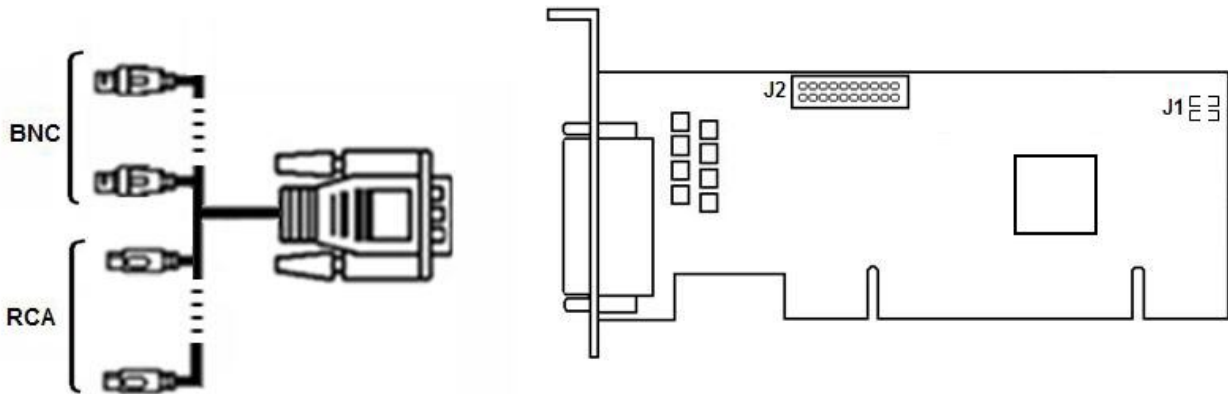

4.4.24 SC590N4 video capture card pins

The SC230N4 video capture card has four external SDI sockets, used to connect video cameras and audio input devices. Simultaneous connection of up to 4 cameras is possible. There also are two 3.5-jack sockets. DI/DO card is connected to the J2 pin. The Watchdog cable is connected to the J1 pin.

Note.

Both SDI sockets and analog inputs can be used for audio signal input.

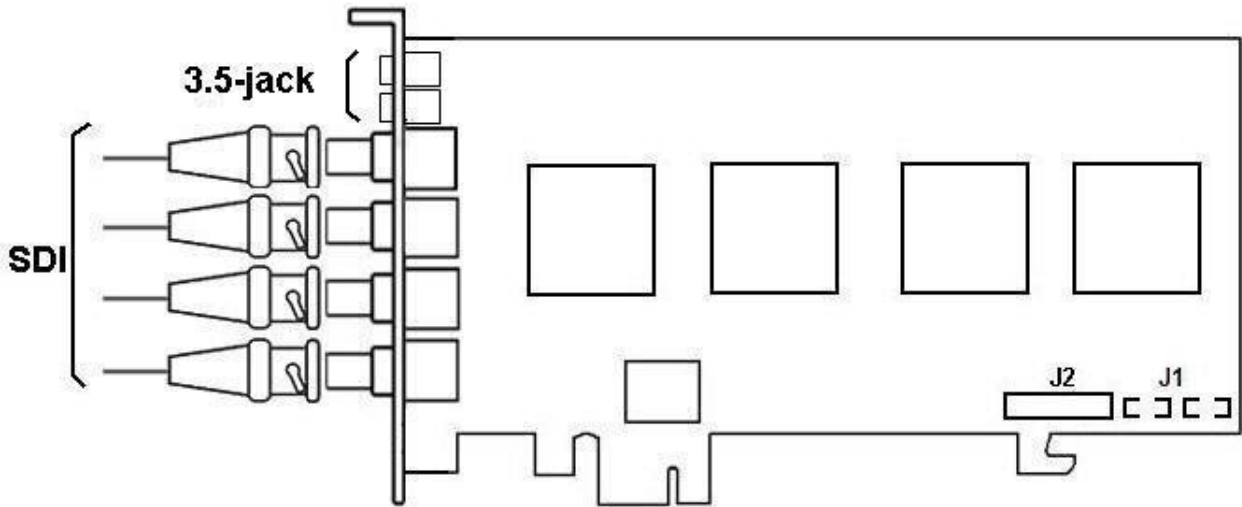

4.4.25 SC330Q16 video capture card pins

SC330Q16 video capture card has one external DVI-I (24+5) pin. Video and audio connection is performed with the help of DVI-I/BNC and DVI-I/RCA stubs correspondingly. Simultaneous connection of up to 16 cameras and up to 4 sound sources to one external pin of SC330Q16 video capture card is possible. The Watchdog cable is connected to the J1 pin.

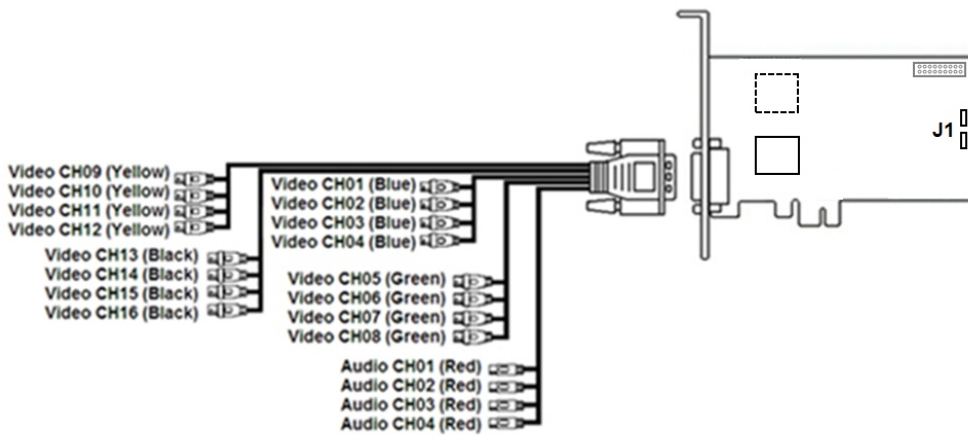

4.4.26 SC330D16 video capture card pins

SC330D16 video capture card has two external DVI-I (24+5) pins. Video and audio connection is performed with the help of DVI-I/BNC and DVI-I/RCA stubs correspondingly. Simultaneous connection of up to 8 cameras and up to 4 sound sources to one external pin of SC330D16 video capture card is possible. The Watchdog cable is connected to the J1 pin.

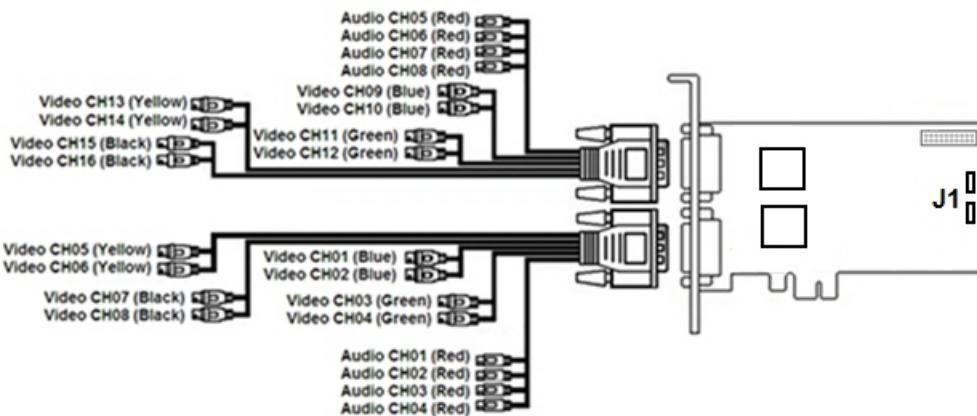

4.4.27 SC3C0N8-L video capture card pins

SC3C0N8-L video capture card has one external DVI-I pin. Video and audio connection is performed with the help of DVI-I/BNC and DVI-I/RCA stubs correspondingly. Simultaneous connection of up to 8 cameras and up to 8 sound sources to one external pin of SC3C0N8-L video capture card is possible.

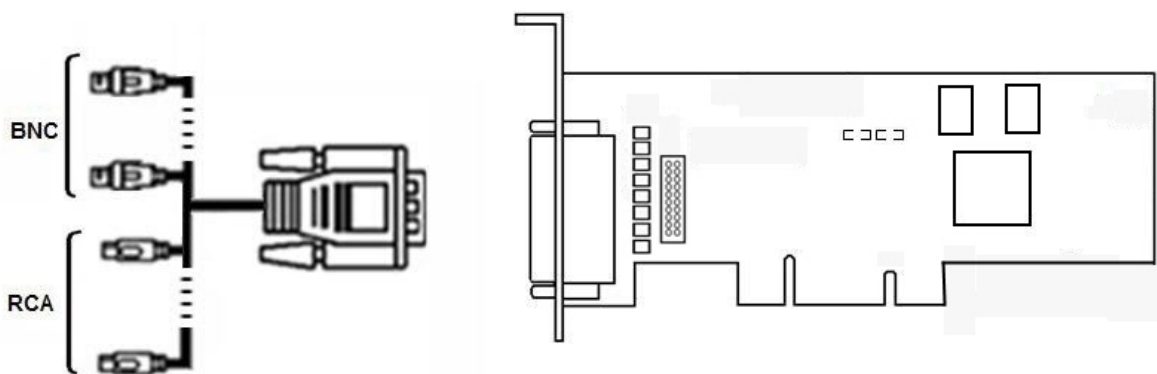

4.5 Appendix 5. Electrical and technical specifications of Sensor-Relay cards

4.5.1 Electrical and technical specifications of Sensor-Relay cards

Sensor-Relay cards are multichannel digital-analogue converters and transmitters of up to 4 control signals to executive devices (relays) designed to be used in video surveillance systems built using FS-5, FS-6, FS-16 and FS-8 video capture cards.

While working with Sensor-Relay cards it is necessary to take into account the following electrical specifications:

1. Current state of a sensor.
Depending on the value of resistance between input contacts on the line, the current state of a sensor can be:
 - a. close (below 3 kilohms);

- b. open (over 10 kilohms);
- c. undefined (from 3 to 10 kilohms).

Note
Undefined state may be determined by the system as close or open.

- 2. State of a relay at the output.
State of a relay at the output is to be be **Open** for Sensor-Relay card. The following conditions are to be met:
 - a. maximum current through the open collector– 150 milliamperes;
 - b. resistance – 24 volts;
 - c. minimal resistance of connected relay– 160 ohms.

Technical specifications of Sensor-Relay cards are to be taken into account while connecting the sensors.

Parameter	4/4 Sensor-Relay cards	16/4 Sensor-Relay cards
Guard loops (sensors)	4	16
Breakdown voltage	1000 V up to 1 minute	1000 V up to 1 minute
Control output (relays)	4	4
Open collector (interface)	24, 30 ma	24, 30 ma

4.5.2 Electrical and technical specifications of 4/4 Sensor-Relay (low profile) cards

4/4 Sensor-Relay (low profile) card is to be used in video surveillance systems installed with SC200Q4 Low profile (FS115) / SC300Q16 (FX4) / SC300D16 (FX8) / SC310N16 (FX16) / SC230N4 / SC3B0N16 (WS216) / SC590N4 video capture cards.

Electrical and technical specifications of 4/4 Sensor-Relay (low profile) cards are given in the table:

Parameter	Sensor		Relay
Number of guard loops	4		4
Triggering time	0.1 ms		OFF -> ON: 3.0 ms ON -> OFF: 2.5 ms
Maximum value of current strength and voltage			direct current: 2 A/24 V alternating current: 1 A/120 V
Triggering level	Up to 5 V	Up to 12 V	

Parameter	Sensor		Relay
	2.5 V – OFF	4.5 V –OFF	
	2.1 V – ON	2.1 V – ON	

4.5.3 Electrical and technical specifications of MO USBIO 4x4 devices

Power is supplied to MO USBIO 4x4 device via the USB. Maximum permissible current consumed by the device is not more than 500 ma.

The MO USBIO 4x4 device has a galvanic isolation of DI/DO circuits (sensors and relays) against the USB (breakdown voltage is 1000 V up to 1 minute). Electrical and technical specifications of MO USBIO 4x4 device are given in the table.

Parameter	Relay (output circuit)	Sensor (input circuit)
Number of loops	4	4
Maximum permissible current	400 ma (in any direction)	50 ma (in any direction)
Ampere rating	-	8 ma (in any direction)
Voltage rating	-	24 V (in any direction)
Maximum permissible voltage	60 V (in any direction)	-
Embedded power supply	-	24 V

4.5.4 Electrical and technical specifications of SL USBIO (4x4, 16x8 and 24x4) card

Pinout of an external pin of the SL USBIO card is given in the figure.

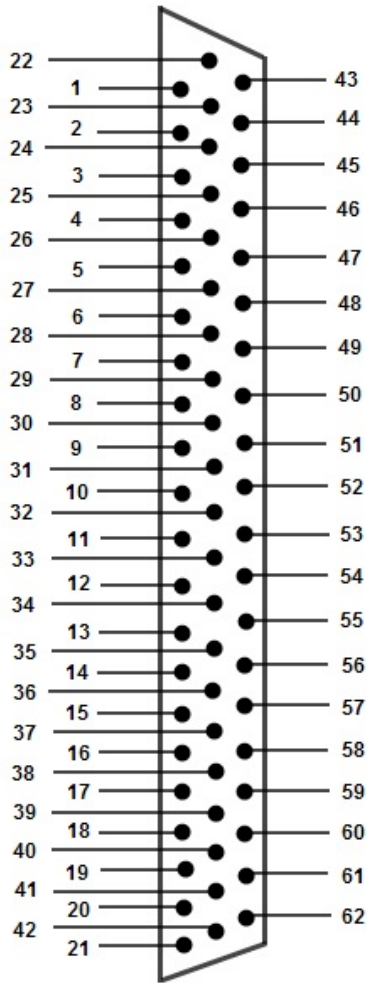

Pinout of an external pin of SL USBIO 16x8 and USBIO 24x4 cards.

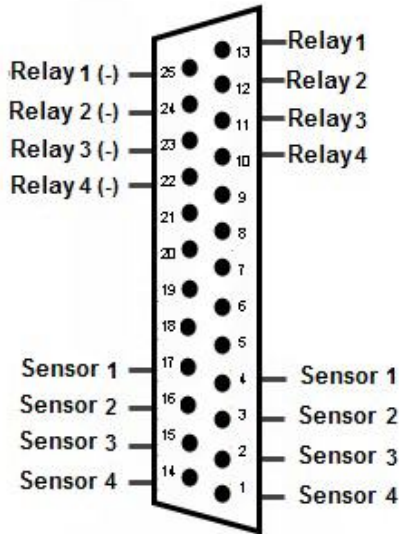

Description of channels of SL USBIO 16x8 and SL USBIO 24x4 cards is given in the table.

USBIO 16x8				USBIO 24x4			
Contact	Application	Contact	Application	Contact	Application	Contact	Application
1	Sensor 1	32	Sensor 14	1	Sensor 1	32	Sensor 14
2	Sensor 1	33	Sensor 14	2	Sensor 1	33	Sensor 14
3	Sensor 2	34	Sensor 15	3	Sensor 2	34	Sensor 15
4	Sensor 2	35	Sensor 15	4	Sensor 2	35	Sensor 15
5	Sensor 3	36	Sensor 16	5	Sensor 3	36	Sensor 16
6	Sensor 3	37	Sensor 16	6	Sensor 3	37	Sensor 16
7	Sensor 4	38	Not used	7	Sensor 4	38	Not used
8	Sensor 4	39	Not used	8	Sensor 4	39	Not used
9	Sensor 5	40	Not used	9	Sensor 5	40	Not used
10	Sensor 5	41	Relay 3 (+)	10	Sensor 5	41	Relay 3 (+)
11	Sensor 6	42	Relay 3 (-)	11	Sensor 6	42	Relay 3 (-)

USBIO 16x8				USBIO 24x4			
Contact	Application	Contact	Application	Contact	Application	Contact	Application
12	Sensor 6	43	Not used	12	Sensor 6	43	Sensor 17
13	Sensor 7	44	Not used	13	Sensor 7	44	Sensor 17
14	Sensor 7	45	Not used	14	Sensor 7	45	Sensor 18
15	Sensor 8	46	Not used	15	Sensor 8	46	Sensor 18
16	Sensor 8	47	Not used	16	Sensor 8	47	Sensor 19
17	Not used	48	Not used	17	Not used	48	Sensor 19
18	Relay 1 (+)	49	Not used	18	Relay 1 (+)	49	Sensor 20
19	Relay 1 (-)	50	Not used	19	Relay 1 (-)	50	Sensor 20
20	Relay 2 (+)	51	Relay 5 (+)	20	Relay 2 (+)	51	Sensor 21
21	Relay 2 (-)	52	Relay 5 (-)	21	Relay 2 (-)	52	Sensor 21
22	Sensor 9	53	Relay 6 (+)	22	Sensor 9	53	Sensor 22
23	Sensor 9	54	Relay 6 (-)	23	Sensor 9	54	Sensor 22
24	Sensor 10	55	Relay 7 (+)	24	Sensor 10	55	Sensor 23
25	Sensor 10	56	Relay 7 (-)	25	Sensor 10	56	Sensor 23
26	Sensor 11	57	Relay 8 (+)	26	Sensor 11	57	Sensor 24
27	Sensor 11	58	Relay 8 (-)	27	Sensor 11	58	Sensor 24
28	Sensor 12	59	Not used	28	Sensor 12	59	Not used
29	Sensor 12	60	Not used	29	Sensor 12	60	Not used

USBIO 16x8				USBIO 24x4			
Contact	Application	Contact	Application	Contact	Application	Contact	Application
30	Sensor 13	61	Relay 4 (+)	30	Sensor 13	61	Relay 4 (+)
31	Sensor 13	62	Relay 4 (-)	31	Sensor 13	62	Relay 4 (-)

Electrical and technical specifications of SL USBIO card are given in the table.

Parameter	Characteristic
Polling interval for all alarm inputs	250 ms for all contacts. Not configured.
Galvanic isolation of input/output	1000 V
Interface connection to PC	USB 2.0 up to 5 m
Alarm contacts	<ul style="list-style-type: none"> • Maximum current – 0.5 A • Voltage – 100 V • Power – 10 W
Relay contacts	<ul style="list-style-type: none"> • Permissible voltage - up to 80 V • Minimum triggering voltage - 1.0 V • Minimum triggering current - 5 ma
Real-time clock for event logging	Yes
ROM	For 1000 alarm events
Power supply	Using USB port or PSU, voltage - 9-50 V, consumption - 500 ma

4.5.5 Electrical and technical specifications of AGRG-IO-16/8-WD-DS devices

When connecting the AGRG-IO-16/8-WD-DS sensor-relay cards, the electrical and technical specifications shown in the table below should be considered.

Parameter	Specification
Galvanic isolation on inputs/outputs	3750 V

Parameter	Specification
Inputs	Quantity - 16 Type - current loop Galvanic isolation - Yes Maximum voltage - 60 V Rated voltage - 12 V Maximum current - 60 mA
Outputs	Quantity - 8 Type - open collector Galvanic isolation - Yes Maximum voltage - 300 V Maximum current - 150 mA Minimum pick-up voltage - 1.0 V Minimum pick-up current - 5 mA
Reset Timer (Watchdog)	Customizable
Ping interval of all alarm inputs	100 ms for all contacts. Customizable
PC connection interface	USB 2.0, up to 5 meters
Power supply	500 mA consumption from USB port

4.6 Appendix 6. Maximum number of presets for IP devices

Device	Maximum number of presets
Axis 2130 PTZ	40
Axis 212 PTZ	20
Axis 213 PTZ	20
Axis 214PTZ	20
Axis 215 PTZ	10
Axis 232D+	50
Axis 233D	100

Axis 241Q	20
Axis 241QA	20
Axis 241S	20
Axis 2400	20
Axis 2400+	20
Axis 243SA	20
Bosch VG4-313-PTE2W	99
Dynacolor Dynahawk 811 IP SpeedDome	255
Dynacolor DynaHawk ZH-801+	255
Panasonic BB HCM311	8
Panasonic BL-C131	8
Panasonic BL-C111	8
Panasonic BB HCM331	8
Panasonic BB HCM381	8
Panasonic BL-C10	8
Panasonic WV-NS202	64
Sony SNC-RZ30P	16
D-Link DCS-5220	20
D-Link DCS-6620G	20
D-Link DCS-6620	20
Lilin PIH-7625PFIP	128
Sony SNC-RZ50P	16
Sony SNC-RZ25P	16
Sony SNC-P5	8
JVC VN-C625U	100

Pelco Spectra IV	128
Smartec STC-IP3975A/2	256
Smartec STC-IP3985A/2	256
TrendNET TV-IP400	24
TrendNET TV-IP410	8
TrendNET TV-IP422	8

5 Installing and configuring security system components guide. CONCLUSION

More detailed information on the Axxon PSIM software package is presented in the documents titled:

1. [Operator's Guide](#);
2. [Programming Guide \(JScript\)](#);
3. [Administrator's Guide](#).

If while operating the given software product you have faced difficulties and problems, you are welcome to contact us. However before addressing us, we kindly ask you to answer the following questions:

1. What is the problem?
2. When did the problem occurred and what had happened before it occurred?
3. Which conditions gave rise to the problem?

Remember, that the more detailed and precise information you give us, the faster our experts will resolve your problem.

We are striving to improve the quality of our products, and hence welcome any proposals and suggestions how to improve our software and documentation.