



# Axxon PSIM Software Integration Guide (HTTP API, IIDK, ActiveX)

PSIM 1.0 (english)

Last update 05/03/2023

## Table of Contents

1	Axxon PSIM Software Integration Guide. Introduction .....	15
2	Hardware and Software Module Integration .....	16
3	CamMonitor.ocx ActiveX Control .....	17
4	Axxon PSIM HTTP API .....	18
5	Axxon PSIM HTTP-Server .....	20
6	Configuring RabbitMQ .....	21
7	APPENDIX 2. NissObjectDLLExt and CoreInterface class declarations.....	22
8	APPENDIX 1. DDI file structure.....	23
9	Axxon PSIM software Integration Guide. Postscript.....	24
10	Axxon PSIM Software Integration Guide. Introduction .....	25
11	Hardware and Software Module Integration .....	26
11.1	Integrating hardware and software modules with Axxon PSIM .....	26
11.1.1	General information on hardware and software modules integrating .....	26
11.1.2	Editing the DBI file.....	26
	Adding Objects to psim.dbi .....	27
	Using the ddi.exe Tool to Work with DBI files .....	29
11.1.3	Editing the DDI file .....	31
	Adding Object Information to psim.ddi .....	32
	Using the ddi.exe Tool to Work with DDI files.....	33
11.1.4	Additional Functionality of the ddi.exe Utility.....	35
11.1.5	Creating MDL files .....	37
11.1.6	Creating RUN files .....	45
11.1.7	Creating and configuring integrated objects (modules) in Axxon PSIM.....	46
11.2	Axxon PSIM Integration Developer Kit (IIDK) .....	47
11.2.1	General Information on IIDK.....	47
	Purpose of the IIDK .....	47
	Developer Requirements .....	47
	IIDK Components .....	47
11.2.2	Connecting to Axxon PSIM .....	48
	Connection Parameters.....	48

IIDK Interface Object .....	48
Configuring passing events through IIDK Interface object .....	49
Features of ATMs integration. ATM object .....	50
11.2.3 IIDK Functions .....	51
Connect .....	51
SendMsg .....	52
Disconnect.....	53
Other functions .....	53
11.2.4 Sent Message Syntax .....	57
Message Syntax .....	57
Message Syntax (port 900) .....	58
Using the Event and React classes .....	58
11.2.5 Examples of Managing System Objects .....	59
Adding, Updating, and Deleting System Objects .....	59
Working with the System in the Multiuser Mode.....	60
Determining Computers Where Axxon PSIM was Unloaded (via Port 1030) .....	60
Redirecting Video Cameras to the Monitor.....	60
Obtaining Object Parameters (via Port 1030 ) GET_CONFIG .....	61
Obtaining Information on Object States GET_STATE and GET_LIST .....	62
Showing Information Messages. SET_STATE .....	62
Live and archived video .....	63
Telemetry control via IIDK .....	64
Map layer operations .....	64
Obtaining info on core queues with GET_QUEUE_INFO command .....	65
Playing audio archive for a period. START_PLAY_TIME command .....	65
Playback of the dial tone. The START_TONE and STOP_TONE commands .....	66
<b>12 CamMonitor.ocx ActiveX Control .....</b>	<b>67</b>
12.1 General description of CamMonitor.ocx component of ActiveX .....	67
12.1.1 General information.....	67
12.1.2 Requirements to developers .....	67
12.2 How to install CamMonitor.ocx .....	67
12.3 CamMonitor.ocx parameters.....	68
12.3.1 CamMenuOptions .....	68
12.3.2 CamMenuProcessingOptions .....	69

12.3.3	CamButtonsOptions .....	70
12.3.4	MainPanelOptions.....	70
12.3.5	KeysOptions .....	71
12.3.6	OverlayMode .....	71
12.3.7	How to use parameters.....	72
12.4	CamMonitor.ocx methods .....	72
12.4.1	Connect .....	72
12.4.2	ShowCam .....	73
12.4.3	DoReactMonitor .....	73
12.4.4	RemoveAllCams .....	74
12.4.5	IsConnected .....	74
12.4.6	GetCurlp.....	74
12.4.7	SendRawMessage .....	74
12.4.8	Disconnect.....	74
12.4.9	SetCallBackOptions .....	74
12.4.10	SetParam .....	75
12.5	CamMonitor.ocx events.....	75
<b>13</b>	<b>Axxon PSIM HTTP API.....</b>	<b>76</b>
13.1	Calling API of vertical solutions via Axxon PSIM HTTP API.....	76
13.1.1	General request format.....	76
13.1.2	Request parameters.....	76
13.1.3	Request examples .....	77
13.1.4	Response examples .....	77
13.2	General information on HTTP API .....	77
13.2.1	Authorization.....	78
13.2.2	Default response format.....	78
13.2.3	Cross domain requests (CORS).....	78
13.3	Product version .....	78
13.3.1	General request format:.....	78
13.3.2	Request example:.....	78
13.3.3	Response example: .....	78
13.4	Authorization using a token key.....	79
13.4.1	General format of request: .....	79
13.4.2	Request parameters:.....	79

13.4.3	Request example:.....	79
13.4.4	Response example: .....	79
13.4.5	Response parameters: .....	80
13.5	Maps.....	80
13.5.1	Getting the list of maps.....	80
	General request format:.....	80
	Request example:.....	80
	Response example: .....	80
	Response parameters .....	81
13.5.2	Information on one map.....	84
	General request format:.....	84
	Request parameters:.....	84
	Request example:.....	84
	Response example: .....	84
	Response parameters: .....	84
13.5.3	The list of layers for specific map .....	84
	General request format:.....	84
	Request parameters:.....	84
	Request example:.....	84
	Response example: .....	85
	Response parameters .....	85
13.5.4	Information on a specific layer .....	87
	General request format:.....	87
	Request parameters:.....	88
	Request example:.....	88
	Response example: .....	88
	Response parameters: .....	88
13.5.5	Layer background .....	89
	General request format:.....	89
	Request parameters:.....	89
	Request example:.....	89
	Response example: .....	89
	Errors while request execution:.....	89
13.5.6	The list of point on the layer .....	89
	General request format:.....	89

Request parameters:.....	90
Request example:.....	90
Response example: .....	90
Response parameters: .....	90
13.5.7 Information on a specific point on the layer.....	91
General request format:.....	91
Request parameters:.....	91
Request example:.....	92
Response example: .....	92
Response parameters: .....	92
13.6 Object classes.....	92
13.6.1 The list of object classes on the server .....	92
General request format:.....	92
Request example:.....	92
Response example: .....	93
Response parameters: .....	93
13.6.2 Specific object class.....	93
General request format:.....	93
Request parameters:.....	93
Request example:.....	93
Response example: .....	93
Response parameters: .....	94
13.6.3 The list of states for a specific object class .....	94
General request format:.....	94
Request parameters:.....	94
Request example:.....	94
Response example: .....	94
Response parameters: .....	94
13.6.4 Information on a specific state.....	95
General request format:.....	95
Request parameters:.....	95
Request example:.....	95
Response example: .....	95
Response parameters: .....	95
13.6.5 Getting the icon for a specific state.....	95

General request format:.....	95
Request parameters:.....	95
Request example:.....	96
Response example: .....	96
13.6.6 The list of events for a specific object class .....	96
General request format:.....	96
Request parameters:.....	96
Request example:.....	96
Response example: .....	96
Response parameters: .....	96
13.7 Objects.....	97
13.7.1 Getting list of all server objects .....	97
General request format:.....	97
Request parameters:.....	97
Request example:.....	97
Response example: .....	97
Response parameters: .....	102
13.7.2 Information on a specific object.....	103
General request format:.....	103
Request parameters:.....	104
Request example:.....	104
Response example: .....	104
Response parameters: .....	104
13.7.3 State of a specific object.....	104
General request format:.....	104
Request parameters:.....	104
Request example:.....	105
Response example: .....	105
Response parameters: .....	105
13.7.4 The list of available actions with the object in a specific state.....	106
General request format:.....	106
Request parameters:.....	106
Request example:.....	106
Response example: .....	106
JSON .....	107

Response parameters: .....	108
13.7.5 Getting list of all zones and regions .....	108
General request format:.....	108
Request example:.....	108
Response example: .....	108
Response parameters: .....	110
13.8 Getting events .....	110
13.8.1 General request format:.....	110
13.8.2 Request example:.....	110
13.8.3 Response example: .....	110
13.8.4 Response parameters: .....	111
13.8.5 Getting events of video subsystem in blocks .....	111
General request format:.....	111
Request parameters:.....	111
Request example:.....	112
Response example: .....	112
13.9 Sending commands to server.....	113
13.9.1 General request format:.....	113
13.9.2 Request example:.....	114
13.9.3 Response example: .....	114
13.10 Macros .....	114
13.10.1 Getting parameters of macros .....	114
General request format:.....	114
Request parameters:.....	114
Request example:.....	114
Response example: .....	115
Response parameters: .....	115
13.10.2 Getting the list of macros.....	115
General request format:.....	115
Request parameters:.....	115
Request example:.....	115
Response example: .....	115
Response parameters: .....	115
13.10.3 Macros execution on server request .....	116
General request format:.....	116

Request parameters:.....	116
Request example:.....	116
<b>13.11 Video .....</b>	<b>116</b>
<b>13.11.1 Thumbnails request.....</b>	<b>116</b>
General request format:.....	116
Request parameters:.....	116
Request parameters:.....	117
Request example:.....	117
Response example: .....	118
<b>13.11.2 Configuration request.....</b>	<b>118</b>
General request format:.....	118
Request parameters:.....	118
Request example:.....	118
Response example: .....	118
Response parameters: .....	119
<b>13.11.3 Video query.....</b>	<b>120</b>
General request format:.....	120
Request parameters:.....	120
Request example:.....	121
Response example: .....	121
<b>13.11.4 Curl video request. Main stream format .....</b>	<b>121</b>
General request format:.....	121
Request parameters:.....	121
Request example:.....	122
Response example: .....	122
Response parameters: .....	123
Response example: .....	123
Response parameters: .....	123
Response example: .....	124
Response parameters: .....	124
<b>13.11.5 Format of main stream .....</b>	<b>124</b>
Example request: .....	124
Response parameters: .....	125
Example response:.....	125
Response parameters: .....	126

13.11.6 Camera managing.....	126
General request format:.....	126
Request parameters:.....	126
Request example:.....	127
13.11.7 Authorization by token .....	127
General request format to get a token:.....	127
Request parameters:.....	128
Request example:.....	128
Response example: .....	128
Response parameters: .....	128
General request format for the received token via Web server 2.0: .....	128
Request parameters:.....	129
Request example:.....	129
General request format for the received token via Web-server 1: .....	129
Request parameters:.....	129
Request example:.....	129
13.12 PTZ control .....	129
13.12.1 General request format:.....	129
13.12.2 Request parameters:.....	130
13.12.3 Request example:.....	131
13.13 Using the archive.....	131
13.13.1 Getting list of records (1st way).....	131
General request format:.....	131
Request parameters:.....	131
Request example:.....	132
Response example: .....	132
13.13.2 Getting list of records (2nd way) .....	133
General request format:.....	133
Request parameters:.....	133
Request example:.....	133
Response example: .....	133
13.13.3 Getting video from archive - "arc.play" .....	135
General request format:.....	135
Request parameters:.....	135
Request example:.....	136

Response example: .....	136
13.13.4 Getting one frame from archive - "arc.frame" .....	136
General request format (1st way):.....	136
Request parameters:.....	137
Request example:.....	137
General request format (2nd way): .....	137
Request parameters:.....	137
Request example:.....	138
Response example: .....	138
13.14 Sound.....	138
13.14.1 Getting live sound .....	138
General request format:.....	138
Request parameters:.....	139
Request example:.....	139
Response example: .....	139
13.14.2 Stop streaming live sound .....	140
General request format:.....	140
Request parameters:.....	140
Request example:.....	140
Response example: .....	140
13.14.3 Playing sound from archive .....	141
General request format:.....	141
Request parameters:.....	141
Request example:.....	141
Response example: .....	142
13.14.4 Sending live sound .....	142
General request format:.....	142
Request parameters:.....	142
Request example:.....	142
Response example: .....	142
Response parameters: .....	143
13.15 Get list of users .....	143
13.15.1 General request format:.....	143
13.15.2 Request example:.....	143
13.15.3 Response example: .....	143

13.16	Commands used for ECHD integration .....	149
13.16.1	Retrieving Device Information.....	150
	General request format:.....	150
	Request example:.....	150
	Response example: .....	150
	Response parameters: .....	150
13.16.2	Getting a list of camera IDs.....	151
	General request format:.....	151
	Request example:.....	151
	Response example: .....	151
	Response parameters: .....	151
13.16.3	Ranges of available archive recordings .....	151
	General request format:.....	151
	Request parameters:.....	152
	Request example:.....	152
	Response example: .....	152
13.16.4	Working with video streams .....	152
	GetArchiveURL request.....	152
	GetLiveUrl request .....	153
13.16.5	Archive downloading .....	154
	General request format:.....	154
	Request parameters:.....	154
	Request example:.....	154
	Response example: .....	154
13.16.6	Archive export .....	154
	Creating archive export request.....	154
	Getting export status .....	156
	Deleting archive .....	157
13.16.7	Video surveillance device features management .....	158
	General request format:.....	158
	Request parameters:.....	158
	Request example:.....	160
	Response example: .....	161
13.16.8	Example ECHD commands with NAT .....	161
	General request format:.....	161

Request parameters:.....	162
Request example:.....	162
Response example: .....	162
Response parameters: .....	162
<b>13.17 Sending reactions, events or XML data to Axxon PSIM with HTTP API.....</b>	<b>162</b>
13.17.1 Sending reactions to Axxon PSIM via HttpListener .....	162
General request format:.....	163
Request parameters:.....	163
Request example:.....	163
13.17.2 Sending events on scanned barcode .....	163
General request format:.....	163
Request parameters:.....	163
Request example:.....	164
Response example: .....	164
13.17.3 Sending reactions and events to Axxon PSIM using HTTP request .....	164
General request format:.....	164
Request parameters:.....	165
Request example:.....	165
13.17.4 Sending HTTP API commands using curl tool .....	165
Request example:.....	166
Response example: .....	166
13.17.5 Sending XML file .....	166
General request format:.....	166
Request parameters:.....	166
Request example:.....	167
Response example: .....	167
Response parameters: .....	167
<b>13.18 Configuring the Technoserv integration.....</b>	<b>167</b>
13.18.1 Filling in the ApiBgConfig.xml configuration file.....	167
13.18.2 Examples of commands to work with the Technoserv integration.....	171
Getting a list of cameras .....	171
Get a list of subscriptions .....	171
Create subscription.....	172
Delete subscription .....	172
Delete all subscriptions .....	173

<b>14</b>	<b>Axxon PSIM HTTP-Server .....</b>	<b>174</b>
14.1	General information on HTTP-Server .....	174
14.2	Configuring the HTTP-Server object .....	174
14.3	HTTP-Server requests .....	175
<b>15</b>	<b>Configuring RabbitMQ .....</b>	<b>176</b>
15.1	Axxon PSIM provider and third party receiver .....	176
15.2	Axxon PSIM core receiver .....	177
<b>16</b>	<b>APPENDIX 2. NissObjectDLLExt and CoreInterface class declarations.....</b>	<b>178</b>
16.1	CoreInterface.....	178
16.2	NissObjectDLLExt.....	179
<b>17</b>	<b>APPENDIX 1. DDI file structure.....</b>	<b>182</b>
<b>18</b>	<b>Axxon PSIM software Integration Guide. Postscript.....</b>	<b>184</b>

# 1 Axxon PSIM Software Integration Guide. Introduction

## 2 Hardware and Software Module Integration

- Integrating hardware and software modules with Axxon PSIM
  - General information on hardware and software modules integrating
  - Editing the DBI file
    - Adding Objects to psim.dbi
    - Using the ddi.exe Tool to Work with DBI files
  - Editing the DDI file
    - Adding Object Information to psim.ddi
    - Using the ddi.exe Tool to Work with DDI files
  - Additional Functionality of the ddi.exe Utility
  - Creating MDL files
  - Creating RUN files
  - Creating and configuring integrated objects (modules) in Axxon PSIM
- Axxon PSIM Integration Developer Kit (IIDK)
  - General Information on IIDK
    - Purpose of the IIDK
    - Developer Requirements
    - IIDK Components
  - Connecting to Axxon PSIM
    - Connection Parameters
    - IIDK Interface Object
    - Configuring passing events through IIDK Interface object
    - Features of ATMs integration. ATM object
  - IIDK Functions
    - Connect
    - SendMsg
    - Disconnect
    - Other functions
  - Sent Message Syntax
    - Message Syntax
    - Message Syntax (port 900)
    - Using the Event and React classes
  - Examples of Managing System Objects
    - Adding, Updating, and Deleting System Objects
    - Working with the System in the Multiuser Mode
    - Determining Computers Where Axxon PSIM was Unloaded (via Port 1030)
    - Redirecting Video Cameras to the Monitor
    - Obtaining Object Parameters (via Port 1030 ) GET\_CONFIG
    - Obtaining Information on Object States GET\_STATE and GET\_LIST
    - Showing Information Messages. SET\_STATE
    - Live and archived video
    - Telemetry control via IIDK
    - Map layer operations
    - Obtaining info on core queues with GET\_QUEUE\_INFO command
    - Playing audio archive for a period. START\_PLAY\_TIME command
    - Playback of the dial tone. The START\_TONE and STOP\_TONE commands

### 3 CamMonitor.ocx ActiveX Control

- General description of CamMonitor.ocx component of ActiveX
- How to install CamMonitor.ocx
- CamMonitor.ocx parameters
- CamMonitor.ocx methods
- CamMonitor.ocx events

## 4 Axxon PSIM HTTP API

- Calling API of vertical solutions via Axxon PSIM HTTP API
- General information on HTTP API
- Product version
- Authorization using a token key
- Maps
  - Getting the list of maps
  - Information on one map
  - The list of layers for specific map
  - Information on a specific layer
  - Layer background
  - The list of point on the layer
  - Information on a specific point on the layer
- Object classes
  - The list of object classes on the server
  - Specific object class
  - The list of states for a specific object class
  - Information on a specific state
  - Getting the icon for a specific state
  - The list of events for a specific object class
- Objects
  - Getting list of all server objects
  - Information on a specific object
  - State of a specific object
  - The list of available actions with the object in a specific state
  - Getting list of all zones and regions
- Getting events
  - Getting events of video subsystem in blocks
- Sending commands to server
- Macros
  - Getting parameters of macros
  - Getting the list of macros
  - Macros execution on server request
- Video
  - Thumbnails request
  - Configuration request
  - Video query
  - Curl video request. Main stream format
  - Format of main stream
  - Camera managing
  - Authorization by token
- PTZ control
- Using the archive
  - Getting list of records (1st way)
  - Getting list of records (2nd way)
  - Getting video from archive - "arc.play"
  - Getting one frame from archive - "arc.frame"
- Sound
  - Getting live sound
  - Stop streaming live sound
  - Playing sound from archive
  - Sending live sound

- [Get list of users](#)
- [Commands used for ECHD integration](#)
  - [Retrieving Device Information](#)
  - [Getting a list of camera IDs](#)
  - [Ranges of available archive recordings](#)
  - [Working with video streams](#)
    - [GetArchiveURL request](#)
    - [GetLiveUrl request](#)
  - [Archive downloading](#)
  - [Archive export](#)
    - [Creating archive export request](#)
    - [Getting export status](#)
    - [Deleting archive](#)
  - [Video surveillance device features management](#)
  - [Example ECHD commands with NAT](#)
- [Sending reactions, events or XML data to Axxon PSIM with HTTP API](#)
  - [Sending reactions to Axxon PSIM via HttpListener](#)
  - [Sending events on scanned barcode](#)
  - [Sending reactions and events to Axxon PSIM using HTTP request](#)
  - [Sending HTTP API commands using curl tool](#)
  - [Sending XML file](#)
- [Configuring the Technoserv integration](#)
  - [Filling in the ApiBgConfig.xml configuration file](#)
  - [Examples of commands to work with the Technoserv integration](#)
    - [Getting a list of cameras](#)
    - [Get a list of subscriptions](#)
    - [Create subscription](#)
    - [Delete subscription](#)
    - [Delete all subscriptions](#)

## 5 Axxon PSIM HTTP-Server

- General information on HTTP-Server
- Configuring the HTTP-Server object
- HTTP-Server requests

## 6 Configuring RabbitMQ

## 7 APPENDIX 2. NissObjectDLLExt and CoreInterface class declarations

## 8 APPENDIX 1. DDI file structure

## 9 Axxon PSIM software Integration Guide. Postscript

[Download Axxon PSIM Demo module](#)



## 10 Axxon PSIM Software Integration Guide. Introduction

This document provides the information needed for *Axxon PSIM* software interaction with external systems. *Axxon PSIM* software has the following interfaces for this:

1. IIDK Interface: intended for integration of functional modules that perform the following tasks:
  - a. Adding new security hardware to the system.
  - b. Implementing new service functions (security hardware management).

The module integration steps are explained using a demonstration module, *Axxon PSIM Demo*, as an example (its source code may be found in an appendix to the documentation).

*Axxon PSIM Demo* module can also be downloaded in section [Axxon PSIM Software Integration Guide \(HTTP API, IIDK, ActiveX\)](#) of the online documentation.

2. CamMonitor.ocx ActiveX Control: the component is similar in every way to the Video monitor interface object. It allows you to manage cameras, view the archive, etc.
3. HTTP API: the program interface allows to send commands and receive data from *Axxon PSIM* software by HTTP requests.
4. RabbitMQ: send and receive messages in *Axxon PSIM* using the RabbitMQ message broker.

## 11 Hardware and Software Module Integration

### 11.1 Integrating hardware and software modules with Axxon PSIM

#### 11.1.1 General information on hardware and software modules integrating

To integrate a hardware and software (functional) module into *Axxon PSIM*, perform the following steps:

1. Edit the DBI file.
2. Edit the DDI file.
3. Prepare a module.mdl file, where “module” is the name of the module to be integrated (this file is a transformed DLL file).
4. Prepare an executable file, module.run, where “module” is the name of the module to be integrated (this file is a transformed EXE file).
5. Copy module.mdl and module.run to the *Axxon PSIM\Modules* folder.

Figure below shows a diagram of interaction between a functional module and the system core.

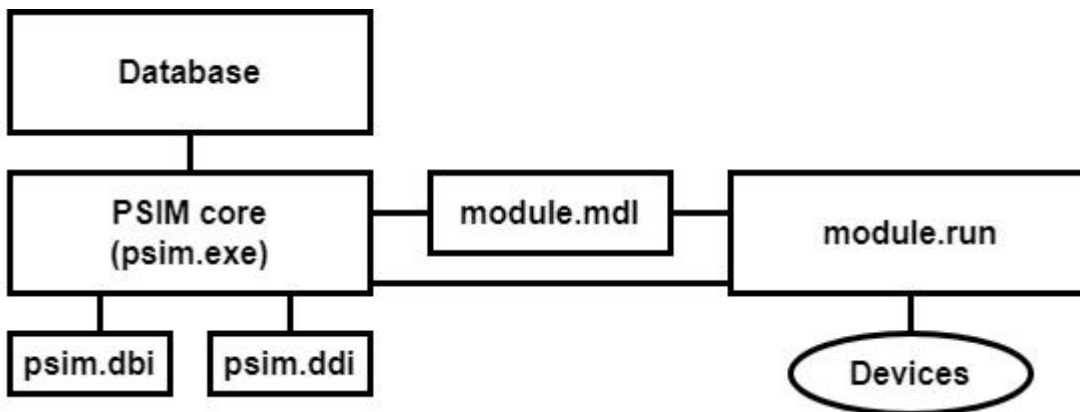

The DBI and DDI files contain information on the integrated functional modules (objects); this information is needed for the operation of the system core. The DBI file describes the structure of *Axxon PSIM*'s configuration database. The DDI file describes the objects and their parameters. When an object is integrated, the name of the object, its parameters, and the related system events and reactions are added to these files.

The MDL file is used for working with one type of objects: it allows you to create, delete, and modify object parameters (during setup or operation), save them in the database, and perform several special operations. The MDL file also ensures that the parameters of created/modified objects are sent to the executable file (the RUN file), and contains the configurations of the object setup panels.

The executable RUN file interacts with devices, passes event information to the core, and enables device management.

In this document, we describe the steps for module integration by using the [DEMO](#) module, which emulates working with virtual hardware. This module includes devices with unique addresses for accessing and polling these devices. The system allows you to perform a number of actions with devices and to pass all their events to the system core.

#### 11.1.2 Editing the DBI file

The psim.dbi file contains the master list of the tables and fields of the database. We recommend that you create your own database template in a separate file and name it psim.xxx.dbi, where xxx is a unique sequence in the

filename. By using a separate file, you avoid double inclusion of the tables and fields after an update to the *Axxon PSIM* software package. On startup of the software package, the DBI files are merged.

## Adding Objects to psim.dbi

Objects are added to psim.dbi as follows:

1. Go to *Axxon PSIM's* root folder and open the psim.dbi file with a text editor.
2. Add the objects to psim.dbi. For each object, you must supply its name (used for identification) in brackets and then declare its fields. Below is the field declaration syntax:

**<Field name>, <Type> [, <Size>]**

 **Note.**

The **Size** may be set for fields of the CHAR type only.

The table below shows the fields mandatory for all objects in *Axxon PSIM*.

Field	Description
id	Unique object ID
name	Object name
parent_id	Parent object ID
flags	Parameter for internal system use

 **Attention!**

The flags field may not be used by external applications.

The following table describes the allowed data types.

Data type	Description
BIT	Used for creating a flag field that takes a logical value, Yes or No.
CHAR	Used for fields that contain short character sequences.
DATETIME	Used for fields that contain dates and times. The date format is YYYY-MM-DD and the time format is HH:MM:SS.XXX.
DOUBLE	Used for fields that contain floating-point numbers.
INTEGER	Used for fields that contain integer numbers.
TEXT	Used for fields that contain text strings.

Beside the mandatory fields, the objects of the DEMO module contain the following fields:

- a. **port** – COM port address;
- b. **address** – device address.

Figure below shows sample object additions and field declarations in psim.dbi.

```
[OBJ_DEMO]
id, CHAR, 16
name, CHAR, 60
parent_id, CHAR, 16
flags, INTEGER
port, CHAR, 5

[OBJ_DEMO_DEVICE]
id, CHAR, 16
name, CHAR, 60
parent_id, CHAR, 16
flags, INTEGER
address, INTEGER
```

3. Save the changes to the psim.dbi file.
4. Go to *Axxon PSIM's* root folder and run the idb.exe utility.

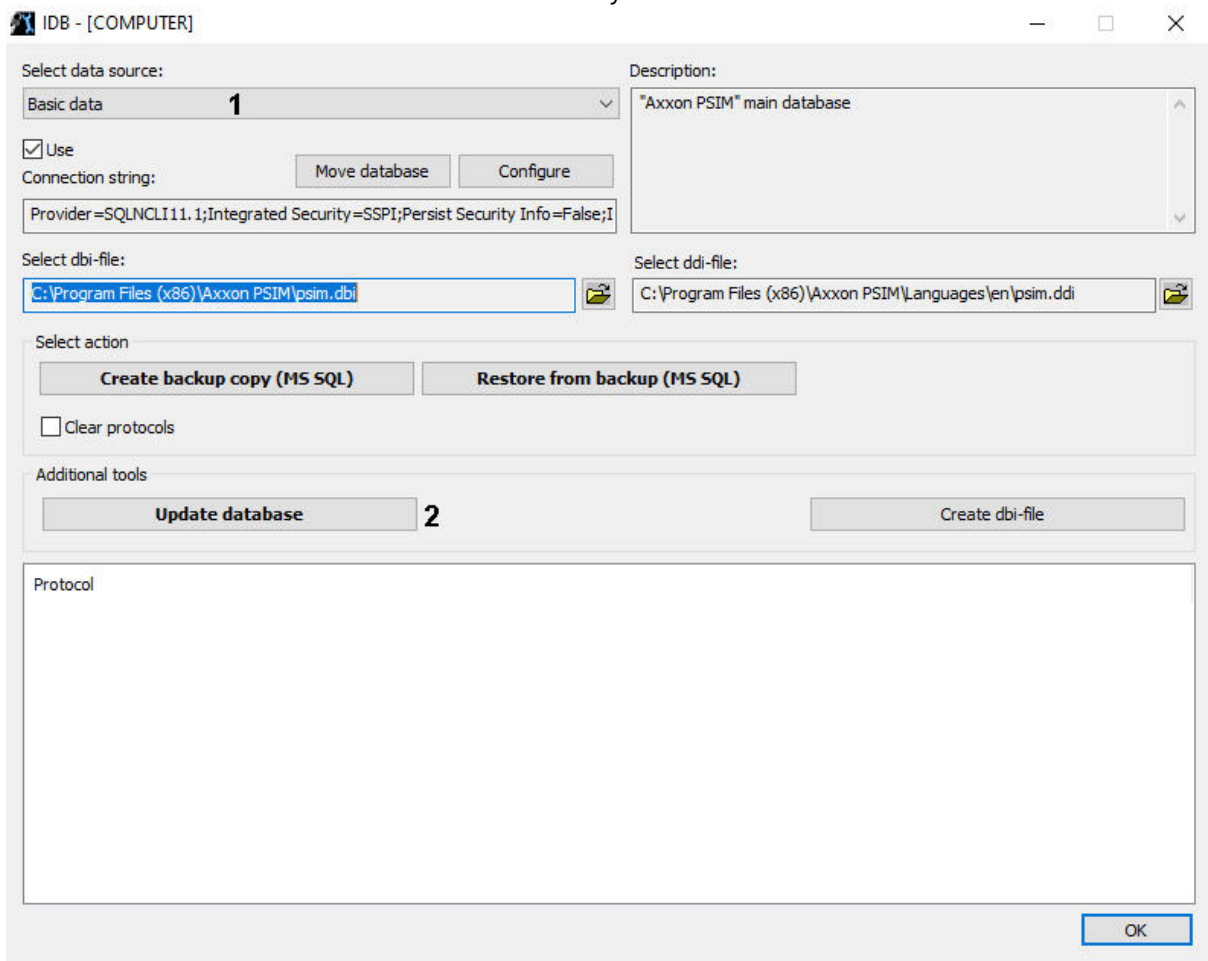

5. In the **Select data source** list, select **Basic data** (1).
6. Click the **Update database** button (2).  
The system will start updating the database structure. The progress will be shown in the **Protocol** window of

idb.exe.

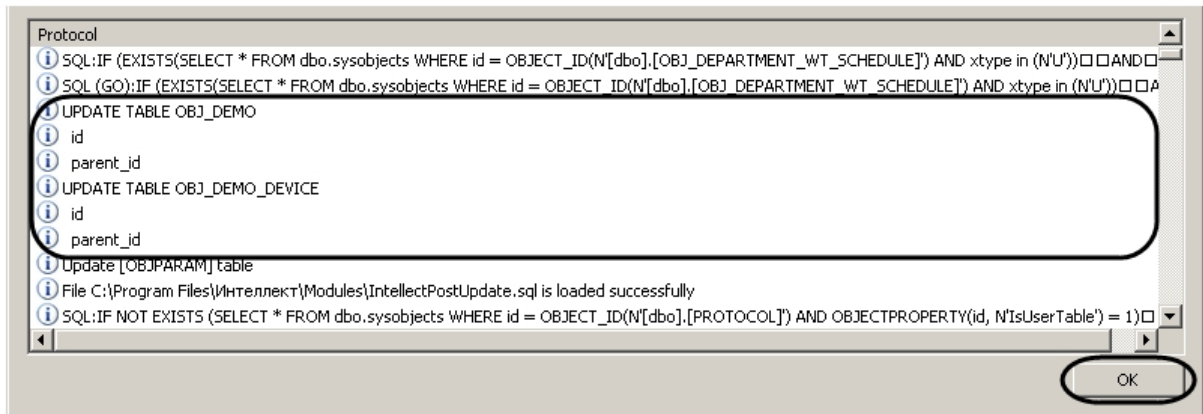

7. Click **OK** to close idb.exe.

As a result of the database structure update, tables are created in *Axxon PSIM's* configuration database.

## Using the ddi.exe Tool to Work with DBI files

To add an object to the DBI file by using the *ddi.exe* utility, do the following:

1. Go to the *Axxon PSIM\Tools* folder and run *ddi.exe*.
2. In the program window, select the **DBI** tab.
3. In the **File** menu, select **Open**. The **Open** dialog box appears.
4. Go to *Axxon PSIM's* root folder and select the *psim.dbi* file. The *ddi.exe* window shows a list of objects.
5. To add the new object, in the list's context menu, select **Add**.

### **Note:**

You may add a new object by pressing the **Insert** key as well.

6. A dialog box opens. In the **ID** field, enter an object name (used for identification) and click **OK**.

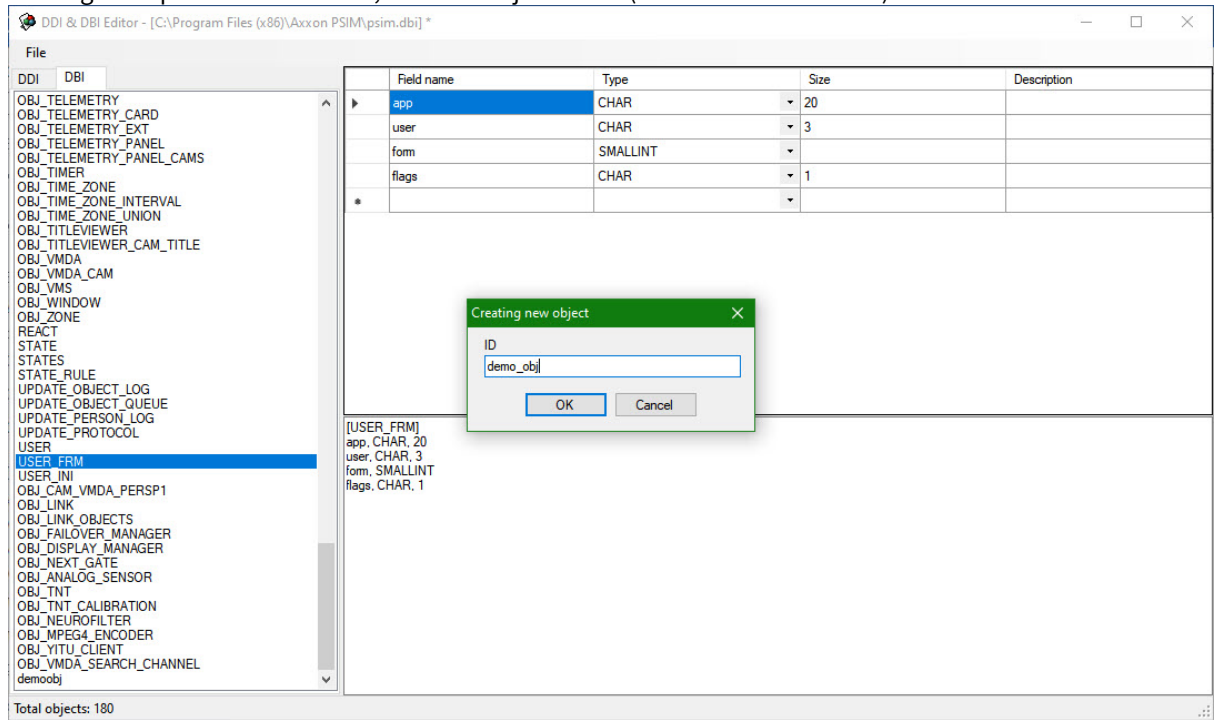

**Note:**

The mandatory fields are automatically added to the created object (see Section [Adding Objects to psim.dbi](#)).

The object has now been added to the DBI file.

To add a field:

1. In the left part of the *ddi.exe* window, select an object.

2. Add a description of the new field (a string) to the table.

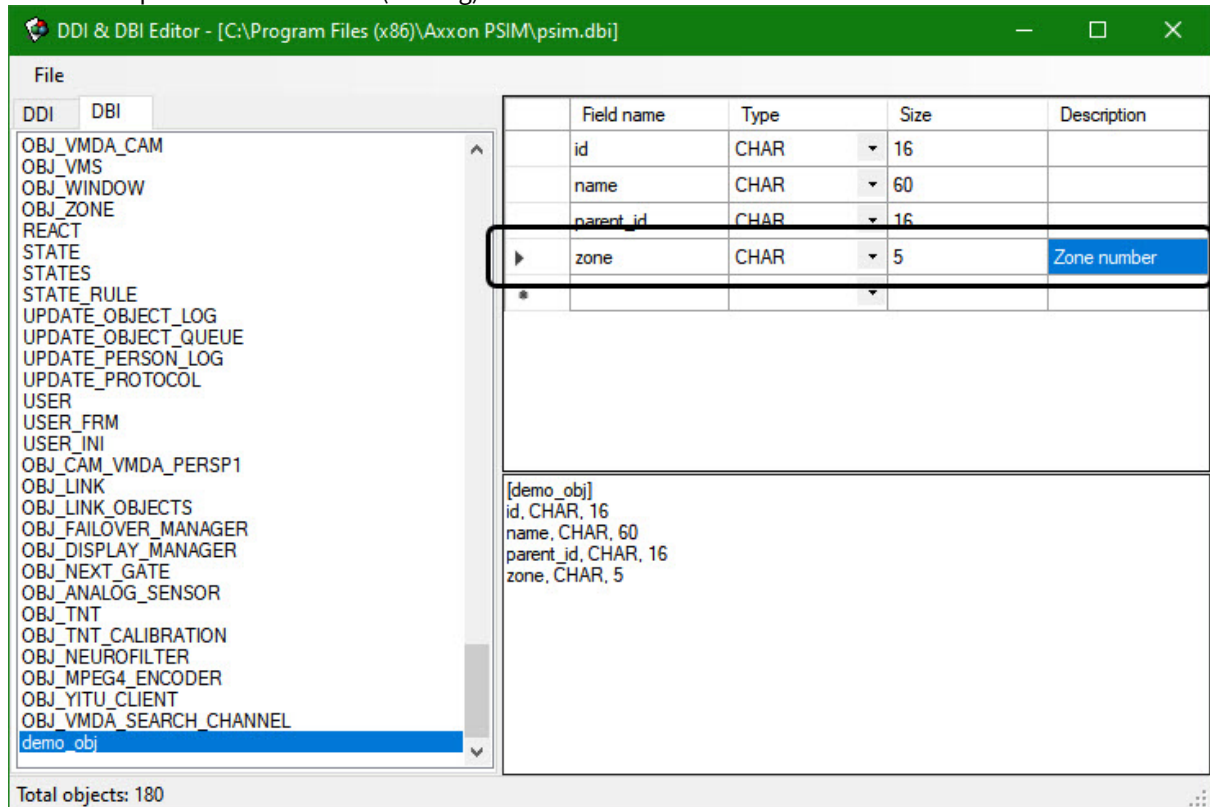

3. To save the changes, in the **File** menu, select **Save**.

The new field is now added.

#### **⚠ Attention!**

After making changes to the DBI file, you must update the database structure by using `idb.exe` (see [Adding Objects to psim.dbi](#)).

### 11.1.3 Editing the DDI file

The DDI file is an XML file that contains the following object information:

1. Reactions (that is, actions that the objects may perform).
2. Events that the objects may generate.
3. States of the objects.
4. Event-driven rules for state transition.
5. The names of the BMP files that are used for visualizing the objects on the *Map*.

The `psim.ddi` file contains the properties of *Axxon PSIM*'s main objects. For your own objects, we recommend creating a separate file, `psim.xxx.ddi`, where `xxx` is a unique part of the filename. By using a separate file, you avoid double inclusion of the properties after an update of the *Axxon PSIM* software package. On startup of the software package, the DDI files are merged.

If an object is duplicated in several ddi-files, then at *Axxon PSIM* software startup the properties of the object from the last file are applied in accordance with the sorting of files by name. For example, if an object is described in files `psim.xxx.ddi`, `psim.xxx1.ddi` and `psim.xxx2.ddi`, the properties from the `psim.xxx2.ddi` will be applied.

## Adding Object Information to psim.ddi

This section shows how to add information on the **DEMO** object to psim.ddi by using a text editor.

To add information on the **DEMO** object, do the following:

1. Go to *Axxon PSIM\Languages\en* folder and open the psim.dbi file with a text editor.
2. Into the **<DataSetDDI>** section, add a child element, **<Objects>**, which contains an object description.

```
<objects>
  <ObjectName>DEMO</ObjectName>
  <visibleName>Demo object</visibleName>
  <GroupName></GroupName>

  <Events>
    <EventName>LOST</EventName>
    <EventDescription>Connection lost</EventDescription>
    <IsSoundEnabled>>false</IsSoundEnabled>
    <IsNetworkDisabled>>false</IsNetworkDisabled>
    <IsProtocolDisabled>>false</IsProtocolDisabled>
    <IsWindowsLogEnabled>>false</IsWindowsLogEnabled>
  </Events>
  <Events>
    <EventName>RESTORE</EventName>
    <EventDescription>Connection restored</EventDescription>
    <IsSoundEnabled>>false</IsSoundEnabled>
    <IsNetworkDisabled>>false</IsNetworkDisabled>
    <IsProtocolDisabled>>false</IsProtocolDisabled>
    <IsWindowsLogEnabled>>false</IsWindowsLogEnabled>
  </Events>
  <Icons>
    <FileName>demo</FileName>
    <IconName>demo</IconName>
  </Icons>
  <States>
    <StateName>DETACHED</StateName>
    <ImgName>detached</ImgName>
    <StateDescription>Armed</StateDescription>
    <IsStateFlashing>>false</IsStateFlashing>
  </States>
  <States>
    <StateName>NORMAL</StateName>
    <ImgName>normal</ImgName>
    <StateDescription>Disarmed</StateDescription>
    <IsStateFlashing>>false</IsStateFlashing>
  </States>
  <Rules>
    <EventName>RESTORE</EventName>
    <FromStateName>DETACHED</FromStateName>
    <ToStateName>NORMAL</ToStateName>
  </Rules>
  <Rules>
    <EventName>LOST</EventName>
    <FromStateName>NORMAL</FromStateName>
    <ToStateName>DETACHED</ToStateName>
  </Rules>
</objects>
```

**Note.**

For the **DEMO** object, the **<Reacts>** sections is missing, because this object does not perform any actions.

**Note.**

The DDI file elements are described in detail in [APPENDIX 1. DDI file structure](#).

3. Save the changes to the psim.ddi file.

The information on the **DEMO** object has now been added to psim.ddi.

**Attention!**

After making changes to the DDI file, you must update the database structure by using `idb.exe` (see Steps 4–7 in Section [Adding Objects to psim.dbi](#)).

## Using the ddi.exe Tool to Work with DDI files

This section shows how to add information on the **DEMO\_SERVICE** object to psim.ddi by using the `ddi.exe` tool.

To add information on the **DEMO\_DEVICE** object, do the following:

1. Open psim.ddi file in one of the following ways:
  - a. Go to the *Axxon PSIM\Tools* folder and run `ddi.exe`.
    - i. In the program window, select the **DDI** tab.
    - ii. In the **File** menu, select **Open**. The **Open** dialog box appears.
    - iii. Go to the *Axxon PSIM\Languages\en* folder and select psim.ddi. The window of `ddi.exe` shows a list of objects.
  - b. Open the *Axxon PSIM\Tools* folder in Windows Explorer or any other file manager, then double-click the psim.ddi file.
2. Add the object by selecting **Add** in the list's context menu or by pressing the **Insert** key.
3. A dialog box opens. In the **ID** field, enter an object name (used for identification) and click **OK**.

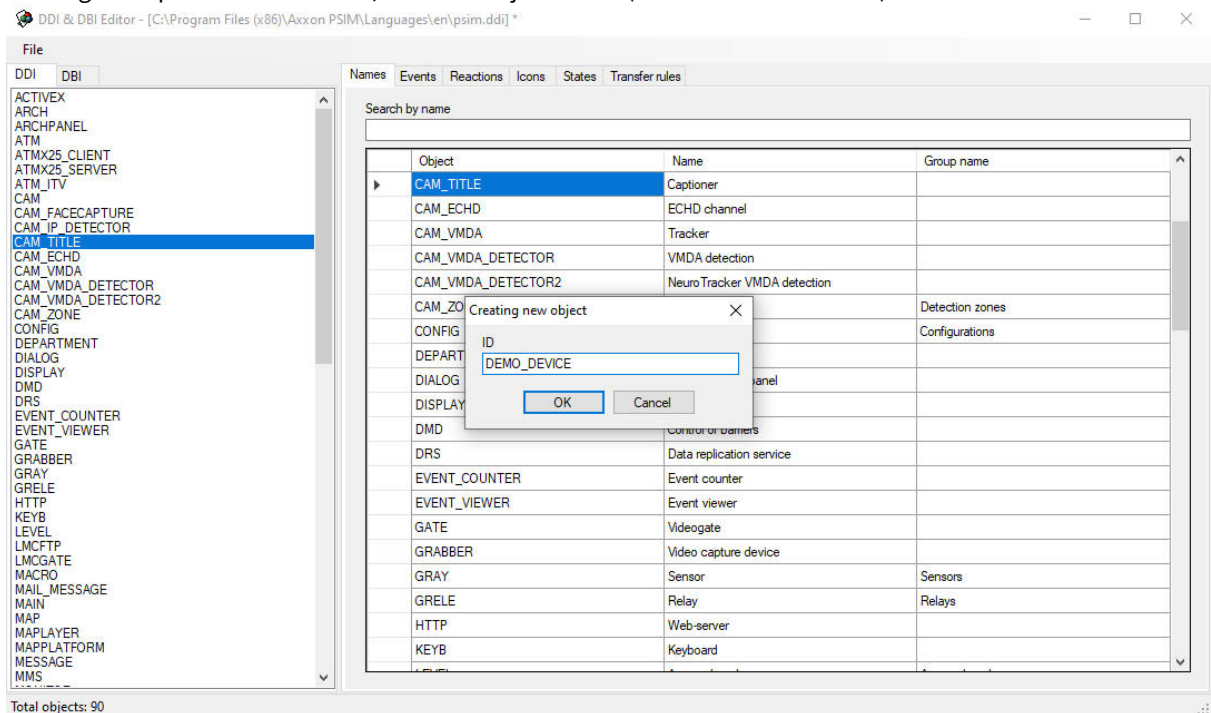

The **DEMO\_DEVICE** object is now shown in the list of objects.

4. In the **Names** tab, enter an object name.

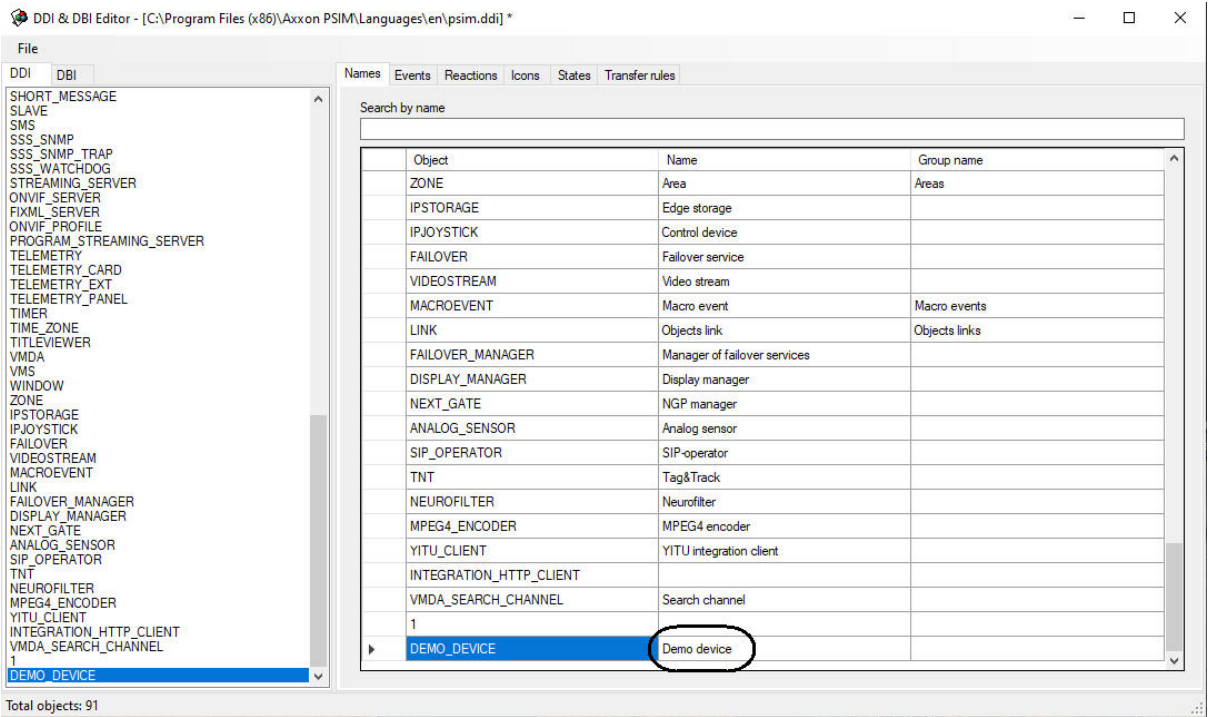

5. In the relevant tabs, add information on the DEMO\_DEVICE object.

a. In the **Events** tab, add the **ON** and **OFF** events.

Names	Events	Reactions	Icons	States	Transfer rules		
	Name	Description	Processing messages	Support audio	Disable network connection	Disable logging	Windows log
	ON	Device is active		<input type="checkbox"/>	<input type="checkbox"/>	<input type="checkbox"/>	<input type="checkbox"/>
	OFF	Device is inactive		<input type="checkbox"/>	<input type="checkbox"/>	<input type="checkbox"/>	<input type="checkbox"/>
*				<input type="checkbox"/>	<input type="checkbox"/>	<input type="checkbox"/>	<input type="checkbox"/>

b. In the **Reactions** tab, add the **ON** and **OFF** actions.

Names	Events	Reactions	Icons	States	Transfer rules
	Reaction	Description	Arming region		
	ON	Enable	<input type="checkbox"/>		
	OFF	Disable	<input type="checkbox"/>		
*			<input type="checkbox"/>		

c. In the **Icons** tab, enter a BMP file name (the part that serves as an image ID). Image IDs allow you to use multiple BMP files to show objects of the same type on the **Map**.

Names	Events	Reactions	Icons	States	Transfer rules
	File name	Name			
	demo-device	DEMO module			
*					

d. In the **States** tab, add the **ON** and **OFF** states. To show an object state on the **Map**, enter a BMP file name (the part that serves as an ID of the state).

Names	Events	Reactions	Icons	States	Transfer rules
	Name	Image	Description	Blinking on alarm	
	ON	on	Enabled	<input type="checkbox"/>	
	OFF	off	Disabled	<input type="checkbox"/>	
*				<input type="checkbox"/>	

**Note.**

The names of the BMP files in the Axxon PSIM\Bmp folder must have the following format:  
 <Image ID>\_<State ID>  
 If an image ID is not set, the BMP file name must be the following:  
 <Object ID>\_<State ID>

**Note.**

The Map may show objects using lines (that is, without using BMP files). In this case, when an object changes its state, the line color changes. For a state, the color (RGB) is set as follows:  
 <State>,\$R:G:B

- e. In the **Transition Rules** tab, set a rule for transitioning from one state to another after a certain event.

Names	Events	Reactions	Icons	States	Transfer rules
	Event			Move from state	Move to state
	OFF			ON	OFF
	ON			ON	ON

**Note.**

If the **Transition from state** field is left blank, the rule will apply to all starting states.

- 6. To save changes, in the **File** menu, select **Save**.

The information on the DEMO\_DEVICE object is now added.

**Note:**

The fields of the ddi.exe tables are described in detail in [APPENDIX 1. DDI file structure](#).

**Attention!**

After making changes to the DDI file, you must update the database structure by using idb.exe (see Steps 4–7 in Section [Adding Objects to psim.dbi](#)).

### 11.1.4 Additional Functionality of the ddi.exe Utility

The *ddi.exe* tool allows you to conveniently delete, add, and edit object properties (such as events and reactions), and copy them to the clipboard. In addition, you can copy object events to the clipboard, as a parameter of the *NotifyEvent* function. To do this, follow the steps below:

1. In the object list's context menu, select **Copy the list of events with NotifyEvent()**.

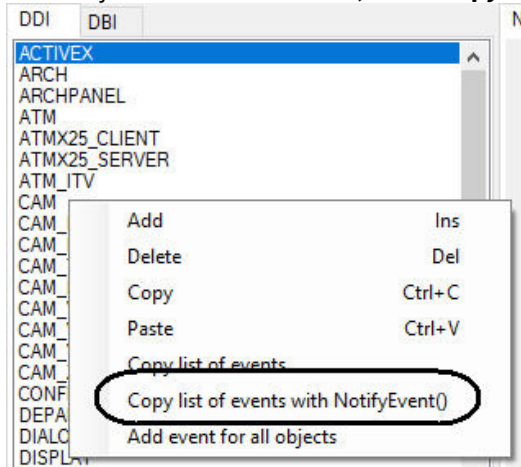

2. A dialog box opens. In the dialog box, enter the object ID to be used by the NotifyEvent function and click **OK**.

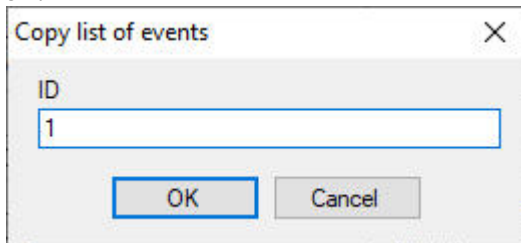

The event list is now copied. The clipboard contains object events in the format shown in the figure below.

```
NotifyEvent("CAM", "1", "ARM");
NotifyEvent("CAM", "1", "ATTACH");
NotifyEvent("CAM", "1", "BLINDING");
NotifyEvent("CAM", "1", "DETACH");
NotifyEvent("CAM", "1", "DISARM");
NotifyEvent("CAM", "1", "DISC_MOUNT");
NotifyEvent("CAM", "1", "DISC_UNMOUNT");
NotifyEvent("CAM", "1", "FILE_REC_ERROR");
NotifyEvent("CAM", "1", "MD_START");
NotifyEvent("CAM", "1", "MD_STOP");
NotifyEvent("CAM", "1", "PRINT");
NotifyEvent("CAM", "1", "REC");
NotifyEvent("CAM", "1", "REC_STOP");
NotifyEvent("CAM", "1", "RECORDER_OFF");
NotifyEvent("CAM", "1", "RECORDER_ON");
NotifyEvent("CAM", "1", "UNBLINDING");
```

To add an event for all objects, in the context menu, select **Add Event for All Objects**. The **Add for All Objects** dialog box opens. In the dialog box, specify the parameters of the new event.

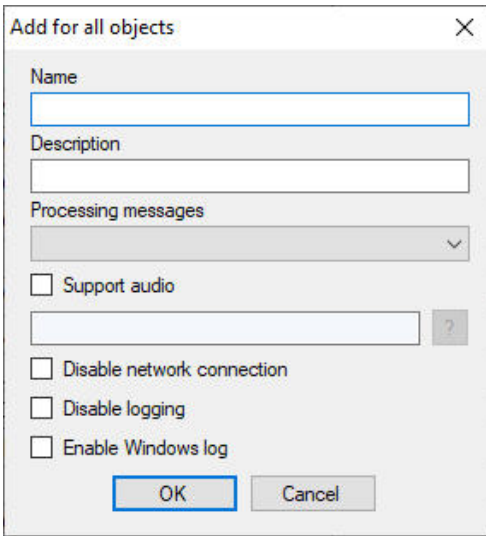

To add objects from other DBI and DDI files, in the **File** menu, select **Insert from File**.

### 11.1.5 Creating MDL files

To create an MDL file, use two classes:

1. *NissObjectDLLExt*. All objects inherit from this class, whose virtual methods are redefined.
2. *CoreInterface*. The methods of this class are used to get parameters of the system's objects.

The declared classes and methods are contained in the *nissdll.h* header file. The code contained in the *nissdll.h* file is shown in [APPENDIX 2. NissObjectDLLExt and CoreInterface class declarations](#).

**Note:**

The methods of a class are the procedures and functions declared in its body.

The methods of the *NissObjectDLLExt* class are described in the table below.

Method	Description	Example
CoreInterface* m_pCore	A pointer to the core interface	
virtual BOOL IsWantAllEvents()	Returns TRUE if the OnEvent function receives events from all objects; returns FALSE if the function receives events from its own object only	If "CAM,GRABBER" is passed as a parameter, when settings of these objects are modified, the DEMO object receives the following messages:
virtual CString DescribeSubscribeObjectsList()	The method accepts a comma-separated list of objects. When an object from the list is modified, the current object is notified	DEMO 1 UPDATE_CAM parameters of the camera  DEMO 1 UPDATE_GRABBER parameters of the video capture card

Method	Description	Example
virtual CString GetObjectType()	Returns the object type	<pre>virtual CString GetObjectType()  { return "DEMO"; }</pre>
virtual CString GetParentType()	Returns the parent object type	<pre>virtual CString GetParentType()  { return "SLAVE"; }</pre>
virtual int GetPos()	Returns the position of the object in the <i>psim.sec</i> key file. <b>Attention! This parameter must be set in consultation with AxxonSoft</b>	<pre>virtual int GetPos()  { return -1; }</pre> <p><i>Note: If Axxon PSIM is run in the demo mode, the function returns -1</i></p>
virtual CString GetPort()	Returns the number of the port used for communication between the object and the core. <b>Attention! This parameter must be set in consultation with AxxonSoft</b>	<pre>virtual CString GetPort()  { return "1100"; }</pre>
virtual CString GetProcessName()	Returns the process name. Used by the core to search for and automatically run the executable module on startup of the system and initialization of the module	<pre>virtual CString GetProcessName()  { return "demo"; }</pre>

Method	Description	Example
virtual CString GetDeviceType()	<p>Determines the type of the object and its behavior.</p> <p>ACD – objects of this type receive all events related to the creation, modification, and deletion of the following objects: <b>Users</b>, <b>Time Zone</b>, and <b>Access Levels</b></p> <p>ACD2 – a type similar to ACD, providing the additional (provided by the core) functionality of deleting temporary (fixed-term) cards</p> <p>The ACR type means that the object is a reader</p>	All objects of the ACR type are available in the <b>Access Point</b> drop-down list
virtual BOOL HasChild()	Returns TRUE if the object has child objects, FALSE otherwise	<pre>virtual BOOL HasChild() { return TRUE; }</pre>
virtual UINT HasSetupPanel()	Returns TRUE if the object has a setup panel, FALSE otherwise	<pre>virtual UINT HasSetupPanel() { return TRUE; }</pre>
virtual void OnPanelInit(CWnd*)	Used when the object's setup panel is initialized. The parameter is a pointer to the setup panel's window	

Method	Description	Example
virtual void OnPanelLoad(CWnd*, Msg&)	Used when the setup panel is loaded for setting the parameters of the object. The parameters are the setup panel's window and a message used to pass the parameters and fill in the relevant fields of the setup panel	<pre> virtual void OnPanelLoad(CWnd* pwnd,Msg&amp; params)  {  CString s;  s = arams.GetParam("port");  pwnd-&gt;GetDlgItem(IDC_PORT)-&gt; SetWindowText(s);  }                     </pre>
virtual void OnPanelSave(CWnd*, Msg&)	Used when the setup panel is saved for saving the parameters of the object. The parameters are a pointer to the setup panel's window and a reference to a message used to pass the parameters and save them in a database	<pre> virtual void OnPanelSave(CWnd* pwnd,Msg&amp; params)  {  CString s;  pwnd-&gt; GetDlgItem(IDC_PORT)-&gt; GetWindowText(s);  params.SetParam("port",s);  }                     </pre>
virtual void OnPanelExit(CWnd*)	Used when the object's setup panel is closed ("exited"). The parameter is a pointer to the setup panel's window	

Method	Description	Example
<p>virtual void OnPanelButtonPressed(CWnd*,UINT)</p>	<p>Used to handle clicks on the setup panel's buttons. The parameters are a pointer to the setup panel's window and a button ID.</p> <p><i>Note: A button ID must be a number equal to or greater than <b>1151</b>. For example, the Resource.h file defines the ID of the <b>Test</b> button as follows:</i></p> <p><b>#define IDC_TEST 1151</b></p> <p>If a button click is to open your own dialog box created in the same MDL file, you must first use the code shown in the example below</p>	<pre>Virtual void OnPanelButtonPressed (CWnd* pwnd,UINT id)  { <b>if</b>(id==IDC_TEST)  { React react("DEMO",Id,"TEST") ;  m_pCore-&gt;DoReact(react); }  }</pre> <pre>HINSTANCE prev_hinst = AfxGetResourceHandle();  HMODULE hRes = GetModuleHandle("demo.mdl");  <b>If</b> (hRes) AfxSetResourceHandle (hRes);  //Code for showing a dialog box:  CXXXDialog dlg;  dlg.DoModal();  AfxSetResourceHandle(prev_hinst);</pre>
<p>virtual BOOL IsRegionObject()</p>	<p>Shows whether the object supports Axxon PSIM's regions. Regions are used to group objects. They can also be used in the report system</p>	

Method	Description	Example
virtual BOOL IsProcessObject()	<p>Shows whether the object supports starting and running multiple executable modules simultaneously. For example, this may be used for starting a separate module for each COM port.</p> <p><i>Note: We recommend using one RUN file. This makes it easier to debug and modify the module</i></p>	
virtual void OnCreate(Msg&)	Used when the object is created. The parameter is a reference to a message that contains object information. The method is also used to set default parameters	<pre data-bbox="935 745 1423 1055">virtual void OnCreate (Msg&amp; msg) {     msg.SetParam ("port","COM1"); }</pre>
virtual void OnInit(Msg&)	Used when the object is initialized. The parameter is a reference to a message that contains object information	<pre data-bbox="935 1120 1423 1397">virtual void OnInit (Msg&amp; msg) {     OnChange (msg, msg); }</pre>

Method	Description	Example
virtual void OnChange(Msg&,Msg &)	Used when the object is changed. The first and second parameters are references to messages that contain object information before and after the change, respectively	<pre> virtual void OnChange(Msg&amp; msg, Msg&amp; prev) {     React react (msg.GetSourceType(), msg.GetSourceId(),"INIT");      react.SetParam("port" ,msg.GetParam("port"));      m_pCore-&gt;DoReact(react); }                     </pre>
virtual void OnDelete(Msg&)	Used when the object is deleted. The parameter is a reference to a message that contains object information	<pre> virtual void OnDelete (Msg&amp; msg) {     React react (msg.GetSourceType(), msg.GetSourceId(),"EXIT");      m_pCore-&gt; DoReact(react); }                     </pre>
virtual void OnEnable(Msg&)	Used to handle clicks on the <b>Disable</b> button of <i>Axxon PSIM's</i> panel when the object is enabled. The parameter is a reference to a message that contains object information	
virtual void OnDisable(Msg&)	Used to handle clicks on the <b>Disable</b> button of <i>Axxon PSIM's</i> panel when the object is disabled. The parameter is a reference to a message that contains object information	

Method	Description	Example
virtual BOOL OnEvent(Event&)	Used to handle the events that are passed as the parameter	<pre> virtual BOOL OnEvent(Event&amp; event) {   If     (event.GetAction() == "ACCESS_IN"    event.GetAction() == "ACCESS_OUT")   {     Msg per = m_pCore-&gt; FindPersonInfoByCard(event.Get Param("facility_code"), event.GetParam("card")); event.SetParam ("param0", ! per.GetSourceId().IsEmpty() ? per.GetParam("name" ) : event.GetParam("facility_code" ) + event.GetParam("card")); event.SetParam("param1", per.GetSourceId() );   }    Else   If (event.GetAction() == "NOACCESS_CARD")   {     event.SetParam </pre>

Method	Description	Example
		<pre> ("param0",event.GetParam( "facility_code") + event.GetParam("card"));  }  return TRUE;  } </pre>
virtual BOOL OnReact(React&)	Used to handle the reactions that are passed as the parameter	

The `CreateNissObject(CoreInterface* core)` global function creates instances of the described objects, places them in an array (an instance of `CNissObjectDLLExtArray`), and returns a pointer to this array. This function is used to receive a pointer to the core interface. This pointer is later used by objects to call interface methods:

```

CNissObjectDLLExtArray* APIENTRY CreateNissObject(CoreInterface* core)
{
    CNissObjectDLLExtArray* ar = new CNissObjectDLLExtArray;
    ar->Add(new NissObjectDemo(core));
    ar->Add(new NissObjectDemoDevice(core));
    return ar;
}

```

After loading a DDL file, the core calls the `CreateNissObject` function and receives pointers to all the objects in use.

All object setup panels are stored in resources as dialogs. Each dialog ID has the format **IDD\_object\_SETUP**, where **object** is the name of the corresponding object. For example, the ID of the **DEMO object** is **IDD\_DEMO\_SETUP**, and the ID of the **DEMO\_DEVICE object** is **IDD\_DEMO\_DEVICE\_SETUP**.

**Note:**

If you want for the settings tree to show a special icon for a particular object, in the resources of the DLL file, create a 14x14 **BITMAP** that contains the object name.

### 11.1.6 Creating RUN files

Devices are managed by exchanging messages (commands) between RUN files and the system core. For implementing this interaction between software modules and the core, use the *Axxon PSIM Integration Developer Kit (IIDK)*, which is covered in detail in Section [Axxon PSIM Integration Developer Kit \(IIDK\)](#). Other information is provided by the source files of the demonstration module; the files may be found in an appendix to this documentation.

Below is an example of how the *IIDK* is used in the *DEMO* module.

```

CString port = "1100";

```

```

CString ip = "127.0.0.1";

CString id = "";

BOOL IsConnect = Connect (ip, port, id, myfunc);

if (!IsConnect)

{

// connection failed

AfxMessageBox("Error");

Return;

}

SendMsg(id,"CAM|1|REC"); // turn on recording for camera 1

SendMsg(id, "DEMO|1|RESTORE"); // restore the connection with the DEMO object

//turn on the DEMO_DEVICE with address 1

SendMsg(id,"DEMO_DEVICE|1|ON|params<1>,param0_name<address>,param0_val<1>");

Disconnect(id);

```

#### **Attention!**

If an MDL file exists, connecting to Axxon PSIM's core does not require creating an IIDK Interface object in the system. The connection ID passed is an empty string (in other words, the ID is "").

When a module is unloaded, it receives the **WM\_EXIT** event:

```
#define WM_EXIT (WM_USER+2000)
```

Use a WinAPI function, *PostThreadMessage*, to catch this message and ensure that the module is unloaded properly. In VC++ and MFC, the **WM\_EXIT** event is caught in a subclass of *CWinApp*; in Delphi and CBuilder, it is caught in a subclass of *TApplication*.

### 11.1.7 Creating and configuring integrated objects (modules) in Axxon PSIM

To create and configure the integrated objects (modules) in *Axxon PSIM*, do the following:

1. Place the MDL and RUN files into the *Axxon PSIM\Modules* directory.
2. Start *Axxon PSIM*.
3. On the basis of the **Computer** object, create the object that was added using the software module. As a result, the object settings panel will be available.

#### **Note**

You can ask AxxonSoft technical support for a sample integration project with demo objects.

4. Make the necessary changes in the object settings panel.
5. Click the **Apply** button.
6. Repeat steps 3-5 for all required objects.

New objects are now created and configured in *Axxon PSIM*.

## 11.2 Axxon PSIM Integration Developer Kit (IIDK)

### 11.2.1 General Information on IIDK

#### Purpose of the IIDK

System expandability is supported by *Axxon PSIM*'s software architecture. Expandability allows communication between the core and functional modules (third party information systems) via TCP/IP.

The figure below shows a diagram of interaction between *Axxon PSIM*'s core and external software (a functional module).

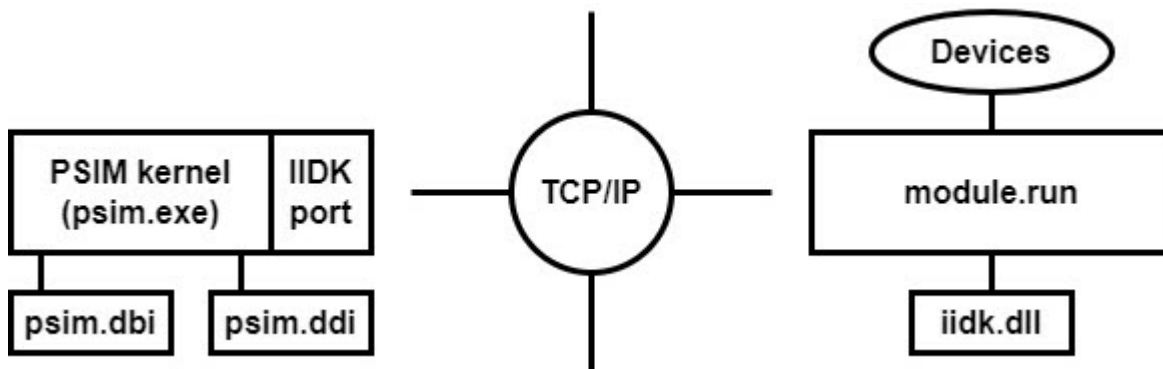

Interaction is done by exchanging messages in a communication environment; message exchange is implemented by using the *IIDK*.

The *Axxon PSIM Integration Developer Kit (IIDK)* is a set of development tools for integrating third-party security software into *Axxon PSIM*. This kit allows you to expand the system rapidly and effectively by adding functional modules that support new hardware and new functions.

#### Developer Requirements

To use the *IIDK*, you must:

1. know how to program in C/C++;
2. know the basics of Win32 programming;
3. have an IDE with DLL support (such as *Microsoft Visual C++*, *C++ Builder*, or *DELPHI*).

#### **Note:**

When creating LIB files with C++ Builder 5's implib.exe tool, add the “- a” option.

#### IIDK Components

The *IIDK* includes the following development tools:

1. *iidk.ocx* – ActiveX control. When installing *Axxon PSIM* this file is stored in the Windows\System32 folder and registered in OS.
2. *ddi.exe* – tool used for viewing and editing DDI- and DBI- files. It is stored in the <*Axxon PSIM* installation directory>\Tools folder.

## 11.2.2 Connecting to Axxon PSIM

### Connection Parameters

*Axxon PSIM's* core interacts with functional modules (third party information systems) according to the following connection parameters:

1. Port number.
  - a. For the video subsystem: 900.
  - b. For the **Interface IIDK** object: 1030.
  - c. For **ATM** objects: 1009.

 **Note.**

1030 (IIDK) port can be in use to connect ATMs (ATM) (not only 1009 port) – in this case the **ATM** object will be marked with red cross in the hardware tree. For this the **IIDK Interface object is to be created in the hardware tree.**

2. The IP address of the computer that is running *Axxon PSIM's* core.
3. ID (the connection object ID).

 **Attention!**

To connect to video subsystem (port 900) id is to be more than 1 and must not be the same as id of **IIDK Interface objects created in the system**. To connect to **IIDK Interface object** (port 1030) id is to be the same as one of the object specified in the dialog box of *Axxon PSIM* settings.

 **Note.**

If connection to the server (**IIDK Interface object**) from remote computer is required, then there is no need to install *Axxon PSIM* on the remote computer, but this computer is to be added to *Axxon PSIM* configuration on the server (in the **Hardware** tab of the **System settings** dialog box) and **IIDK Interface object** is to be created under the created **Computer** object. In this case the server address is to be specified in IP parameter of Connect function and ID of specified **IIDK Interface object** is to be specified in ID parameter. Take into account the fact that the **Computer** object corresponding to the remote computer is marked with a red cross in the object tree.

 **Note:**

If an MDL file exists (see Section [Creating MDL files](#)), the connection to *Axxon PSIM's* core does not require creating the **IIDK Interface** object in the system. The connection ID passed is an empty string (in other words, the ID is "").

### IIDK Interface Object

With the **IIDK Interface** object one can manage all the elements of the system. The **IIDK Interface** object is created under the **Computer** object in the *Axxon PSIM* object tree.

**Note**

To use the **IIDK Interface** object, allow the relevant functionality in the license key.

**Note**

If *Axxon PSIM* is started in the *Demo* mode, the **IIDK Interface** object is activated after the functional module is connected to the system core (see [Connect](#) section).

**Important!**

The ID of the **IIDK Interface** object must not be the same as the IDs of the **Monitor** objects created in the system.

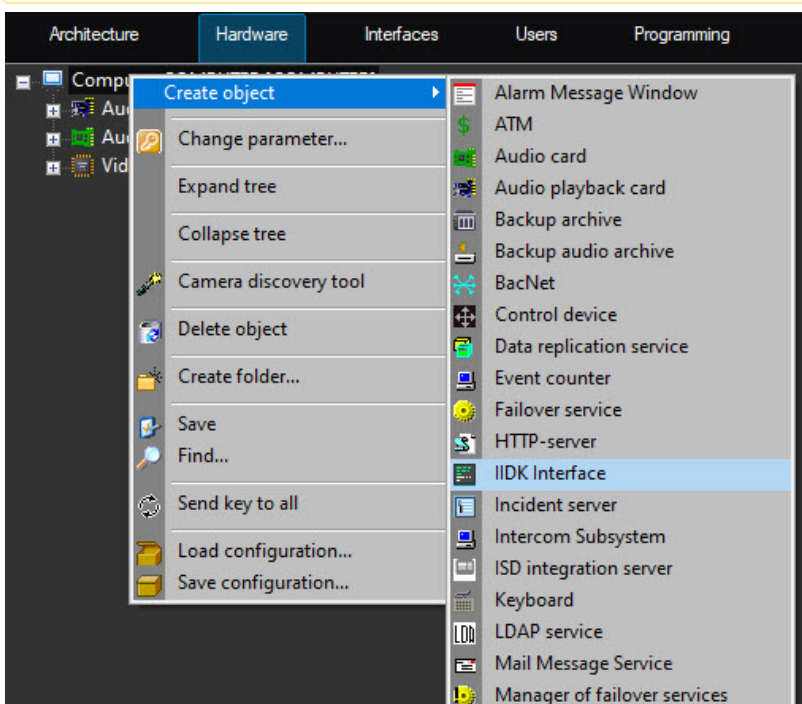

If the **IIDK Interface** object is used, the settings panels are not created for integrated functional modules (third party applications).

When the *Axxon PSIM* distributed architecture is used, the **IIDK Interface** object must be created on the computer that is running the software core (the core to which the connection is made). If the connection is made to a computer that has the *Operator Workstation* installed, the connection parameters must include the IP address of the *Server* or the *Administrator Workstation*.

### Configuring passing events through IIDK Interface object

**IIDK Interface** allows configuring of event filtering passed to connected client applications.

To configure filtering, do the following:

1. Go to the settings panel of the created **IIDK Interface** object.

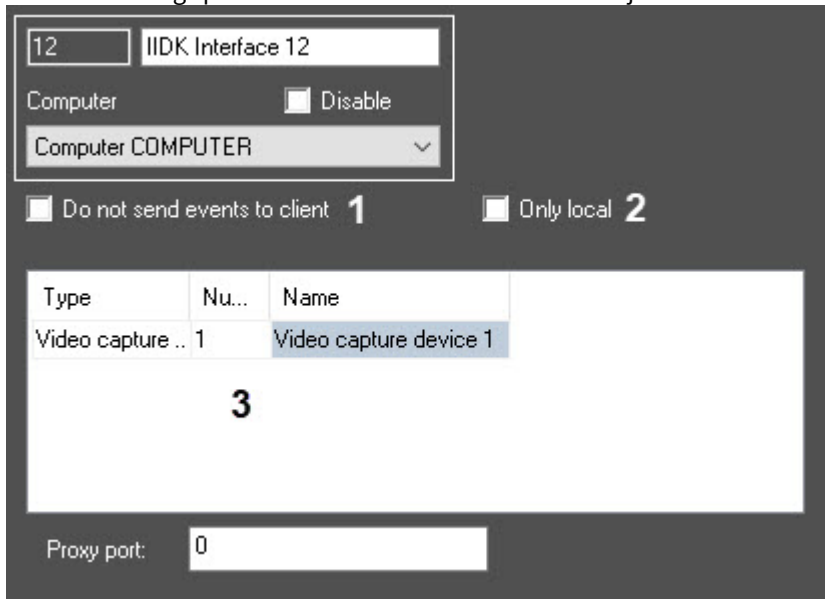

2. Set the **Do not send events to client** if it is not required to send any messages to client application not sending any messages to the core (1).
3. Set the **Only local** checkbox to send to the client applications only messages of those objects created under the same **Computer** object as the **IIDK Interface** object (2).
4. In the table (3) specify list of objects, events from which have to be sent to connected client applications. Enter CORE type to filter the core events.

Configuring of event filtering is completed.

### Features of ATMs integration. ATM object

The **ATM** object can be used to send events from ATM software to *Axxon PSIM* core. This object is created under the **LOCALHOST** object in the **Hardware** tab of the **System settings** dialog box. It is created instead of the **IIDK Interface** object.

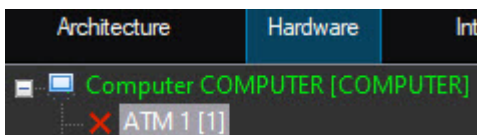

The **ATM** object shows ATM events (“Card inserted”, “Withdraw card”, etc.) in the event viewer. These events can be used for captioning, reactions configuration, etc.

#### **Note.**

For events regarding client card masked bank card number can be sent in the param0 parameter.

The list of available **ATM** events can be seen using the `ddi.exe` utility. Information on how to use this utility can be found in the [The ddi.exe utility for editing database templates and external settings files](#) section.

Connection method and message syntax for the **ATM** object are the same as those for the **IIDK Interface object**, though 1009 port is in use for sending messages (see also [Connection Parameters](#) and [Message Syntax \(port 900\)](#)).

### 11.2.3 IIDK Functions

#### Connect

To establish communication between a functional module and Axxon PSIM, connect to the system core by using the following function:

```

BOOL Connect (LPCTSTR ip, LPCTSTR port, LPCTSTR id, void (_stdcall *func)(LPCTSTR
msg))
    
```

Parameters of the connection function:

Parameter	Description	Example
LPCTSTR ip	The ID address of the computer that is running the system core	<pre> CString port = "900"; CString ip = "127.0.0.1"; CString id = "2";  BOOL IsConnect = Connect(ip, port, id, myfunc);  if (!IsConnect) {     // connection failed      AfxMessageBox("Error"); }                     </pre>
LPCTSTR port	TCP/IP connection port	
LPCTSTR id	A connection ID, for video	
_stdcall *func) (LPCTSTR msg))	A callback function that accepts messages from <i>Axxon PSIM</i>	

The function returns TRUE if the connection is established, or FALSE if not.

All messages from the system core are accepted by a callback function.

A sample declaration of the callback function:

```

void _stdcall myfunc(LPCTSTR str)
{
    printf("\r\nReceived:%s\r\n\r\n",str);
}
    
```



**Note:**

**Void\_stdcall myfunc** is called in a separate stream (not in the application's main stream).

The developer handles received messages as needed.

### SendMsg

To send messages to the system core, use the following function:

```
BOOL SendMsg (LPCTSTR id, LPCTSTR msg)
```

Parameters of the SendMsg function:

Parameter	Description	Example
LPCTSTR id	The connection ID passed in the call to the <b>Connect</b> function	<pre> CString port = "9000"; CString ip = "127.0.0.1"; CString id = "2";  BOOL IsConnect = Connect(ip, port, id, myfunc);  <b>if</b> (!IsConnect) {     // connection failed     AfxMessageBox("Error");     Return; }  SendMsg(id,"CAM 1 REC"); // turn on recording for camera 1  Disconnect (id);                 </pre>
LPCTSTR msg	Message text	

The function returns TRUE if the message was sent, otherwise FALSE

## Disconnect

To terminate a connection, use the **Disconnect** function:

```
void Disconnect (LPCTSTR id)
```

, where **LPCTSTR id** is the connection ID passed in the call to the **Connect** function.

If the connection is terminated by Axxon PSIM, **DISCONNECTED** is passed to the callback function.

**Note:**

An example of using the **Disconnect** function is given in Section [SendMsg](#).

## Other functions

**On the page:**

- [Connect3](#)
- [SendReactToCore](#)
- [IsConnected](#)
- [Connect4](#)
- [SendData4](#)
- [SendFile](#)
- [GetMsg](#)
- [SetPingTime](#)

The iidk.h header file contains extra functions that are listed below. The Connect4, SendData4, SendFile and GetMsg functions should not be used. They are created for internal use. The Connect2 function is not used.

### Connect3

```
BOOL Connect3(LPCTSTR ip, LPCTSTR port, LPCTSTR id, iidk_callback_func* lpfunc,
              DWORD user_param, int async_connect, DWORD connect_attempts)
```

Parameter	Description
ip	IP address of <i>Axxon PSIM</i> Server
port	TCP/IP port over which the connection is established
id	SLAVE connection ID, for video

lpfunc	Callback function receiving messages from <i>Axxon PSIM</i>
user_param	Extra parameter that comes to Callback function in order to split SLAVES if there is only one function
async_connect	0 – synchronous connection mode, the function returns TRUE if the connection is established. -1 – asynchronous connection mode, the function always returns FALSE if the connection is established, then the CONNECTED event is created. Any other value – at first the synchronous mode is used, in case of fault - asynchronous mode
connect_attempts	Number of connection attempts

### SendReactToCore

The function is used to send a reaction to the specific core.

<code>BOOL SendReactToCore(LPCTSTR id, LPCTSTR msg)</code>	
Parameter	Description
id	Core connection ID
msg	Messages sent. Message format is similar to <a href="#">SendMsg</a>

### IsConnected

IsConnected returns TRUE if the client is connected to server.

<code>BOOL IsConnected();</code>
----------------------------------

### Connect4

<code>BOOL Connect4(LPCTSTR ip, LPCTSTR port, LPCTSTR id, iidk_callback_func* lpfunc, iidk_frame_callback_func* lpframe_func, iidk_user_data_func* iidk_user_data_func, DWORD user_param, int async_connect, DWORD connect_attempts);</code>	
Parameter	Description
ip	IP address of <i>Axxon PSIM</i> Server

port	TCP/IP port over which the connection is <i>established</i>
id	Core connection ID, for video
lpfunc	Callback function receiving messages from <i>Axxon PSIM</i>
lpframe_func	Callback function receiving video frames
iidk_user_data_func	Callback function for data sent using the SendData4 function
user_param	Extra parameter that comes to the Callback function in order to split SLAVES if there is only one Callback function for all cores
async_connect	0 – synchronous connection mode, the function returns TRUE if the connection is established  -1 – asynchronous connection mode, the function always returns FALSE. If the connection is established, then the CONNECTED event is created  Any other value – at first the synchronous mode is used, in case of fault - asynchronous mode
connect_attempts	Number of connection attempts

### SendData4

This function is used to send CUserNetObject. Its purpose is to send raw data.

```
BOOL SendData4(LPCTSTR id, int nIdent, BYTE *pBuffer, DWORD dwSize);
```

Parameter	Description
id	Core connection ID
nIdent	Data UID
pBuffer	Transmitted data
dwSize	The size of data array

### SendFile

The function is used to send a file.

```
BOOL SendFile(LPCTSTR id, LPCTSTR file_from, LPCTSTR file_to)
```

Parameter	Description
id	Core connection ID
file_from	Address to send file from
file_to	Address to send file to

### GetMsg

The function is used to retrieve incoming messages that are queued if the Callback function is not specified.

```
BOOL GetMsg(LPTSTR msg, DWORD& cb)
```

Parameter	Description
msg	Incoming message
cb	Message length

### SetPingTime

The function enables and sets the interval for sending KeepAlive messages to the *Axxon PSIM* core. It is enough to call the function once, for example, after calling *CreateClient*.

```
void SetPingTime(intptr_t clientId, unsigned int time);
```

Parameter	Description
clientId	Client ID
time	<p>The interval for sending KeepAlive messages in milliseconds.</p> <p>The minimum value is 5000; if a smaller value (but not 0) is specified, then the value 5000 will be used.</p> <p>If set to 0, then sending KeepAlive messages is stopped.</p>

## 11.2.4 Sent Message Syntax

### Message Syntax

Messages sent to the core have the following syntax:

**CORE||DO\_REACT|source\_type<OBJECT TYPE>,source\_id<OBJECT ID>,action<ACTION> [ ,params<NO. OF PARAMETERS>,param0\_name<PARAMETER NAME\_0>,param0\_val<PARAMETER VALUE\_0>]**

Below is the syntax of messages that contain two parameters.

**CORE||DO\_REACT|source\_type<OBJECT TYPE>,source\_id<OBJECT ID>,action<ACTION>,params<2>,param0\_name<PARAMETER NAME\_0>,param0\_val<PARAMETER VALUE\_0>,param1\_name<PARAMETER NAME\_1>,param1\_val<PARAMETER VALUE\_1>**

The message parameters are described in the table below.

Parameter	Description
source_type<obj>	Object type (see the DDI file ( [OBJTYPE] section) )
source_id<id>	The object ID set when creating the object in <i>Axxon PSIM</i> (see <i>Axxon PSIM's</i> settings tree)
action<react>	Action (see the DDI file (the [REACT] section) )
params<number>	The number of parameters passed, in decimal format
param0_name<str1>	Parameter name
param0_val<str2>	Parameter value

**Note:**

For working with DDI files, we recommend using the ddi.exe utility (see Section [Using the ddi.exe Tool to Work with DDI files](#)).

**Example.** Sending a message to switch the telemetry to preset mode 4.

```
CString msg=
```

```
“CORE||DO_REACT|source_type<TELEMETRY>,source_id<1.1>,action<GO_PRESET>,params<2>,param0_name<preset>,param0_val<4>,param1_name<tel_prior>,param1_val<2>”;
```

```
SendMsg(id,msg);
```

## Message Syntax (port 900)

Messages sent to port 900 are passed to the video subsystem directly; for this reason, such messages have a different syntax.

Messages sent to the video subsystem have the following syntax:

**OBJECT TYPE|OBJECT ID|ACTION [|PARAMETER<VALUE>]**

Below is the syntax of messages that contain n parameters.

**OBJECT TYPE|OBJECT ID|ACTION [|PARAMETER 1<VALUE>,PARAMETER 2<VALUE>,...,PARAMETER N<VALUE>]**

### Attention!

Port 900 may only be used to manage objects of the GRABBER, CAM, or MONITOR types.

The message parameters are described in the table below.

Parameter	Description
Object type	Object type (GRABBER, CAM, or MONITOR)
Object ID	The object ID set during creation of the object in <i>Axxon PSIM</i>
Action	Action (command)
Parameter <Value>	Parameter name. The value is enclosed by angle brackets

**Example 1.** Setting camera 1 to recording mode.

```
CString msg = "CAM|1|REC";
```

```
SendMsg(id,msg);
```

**Example 2.** Saving video from all cameras to local disk C.

```
CString msg = "GRABBER|1|SET_DRIVES|drives<C:\>";
```

```
SendMsg(id,msg);
```

### Note.

The **SET\_DRIVES** command includes the ID of any of the video capture cards created in the system.

### Note.

The **SET\_DRIVES** command does not change the video archiving settings set in the system.

## Using the Event and React classes

For working with messages, you may use the classes provided: *Event* and *React*, declared in the msg.h file.

Example of using the react class:

A message composed without using the classes	A message composed using the React class
<pre> CString msg = "CORE  DO_REACT  source_type&lt;TELEMETRY&gt;,source_id&lt;1.1&gt;, action&lt;GO_PRESET&gt;,params&lt;2&gt;,param0_name&lt;preset&gt;,p aram0_val&lt;4&gt;, param1_name&lt;tel_prior&gt;,param1_val&lt;2&gt;"; SendMsg(id,msg);                     </pre>	<pre> React react("TELEMETRY","1.1","GO_PRESET"); react.SetParamInt("preset",4); react.SetParamInt("tel_prior",2); SendMsg(id,react.MsgToString().c_str());                     </pre>

**Note:**  
 The msg.h and msg.cpp files are located in the Misc folder which is in the archive on page [Axxon PSIM Software Integration Guide \(HTTP API, IIDK, ActiveX\)](#).

### 11.2.5 Examples of Managing System Objects

#### Adding, Updating, and Deleting System Objects

**On the page:**

- [Adding a User to a Department](#)
- [Adding and Deleting a Video Capture Card](#)

System objects are added, updated, and deleted by the following commands:

1. **CORE||CREATE\_OBJECT** – creates a new object.
2. **CORE||UPDATE\_OBJECT** – updates an existing object or creates a new one.
3. **CORE||DELETE\_OBJECT** – deletes an object.

#### Adding a User to a Department

Below is a message that adds the specified user to the specified department, with the specified parameters:

```

CORE||CREATE_OBJECT|
objtype<PERSON>,objid<12341>,parent_id<1>,surname<Tim>,name<Kovac>,card<12362>,facility_code<0>
                    
```

IIDK will return the following message in response to this command:

```

CORE||CREATE_OBJECT|card<1234>,objtype<PERSON>,guid_pk<{281A172C-62D2-EA11-A54B-B06EBF811A34}>,
facility_code<122>,surname<Tim>,module<iidk_client_test_x64.exe>,time<16:42:53>,parent_id<1>,fraction<797>
,date<30-07-20>,name<Kovac>,owner<QA-T49>,SLAVE_id<QA-T49.11>,objid<12341>
                    
```

This allows receiving the ID of the created object in the objid<> parameter.

## Adding and Deleting a Video Capture Card

If an object is not present in the system, add that object with the **UPDATE\_OBJECT** command (the system must not have an object with a type and ID equal to objtype and objid, respectively).

```
CORE||UPDATE_OBJECT|objtype<GRABBER>,objid<12>,core_global<0>,parent_id<SLAVAXP>,name
<Frame grabber 1>,params<5>,param0_name<format>,param0_val<NTSC>,param1_name<mode>,pa
ram1_val<1>,param2_name<chan>,param2_val<2>,param3_name<type>,param3_val<FX 4>,param4
_name<resolution>,param4_val<0>
```

Having received the following message, the system changes the name of an existing object:

```
CORE||UPDATE_OBJECT|objtype<GRABBER>,objid<12>,core_global<0>,parent_id<SLAVAXP>,name<Card 2>
```

To delete an object and all of its child objects, use the **DELETE\_OBJECT** command:

```
CORE||DELETE_OBJECT|objtype<GRABBER>,objid<12>
```

## Working with the System in the Multiuser Mode

The remote computer must install and be running *Axxon PSIM* (**Client** installation version) in order to exchange messages with the Server.

If users have been created and access rights have been configured in *Axxon PSIM*, any message that requires a response from the system core must contain the **receiver\_id<ID>** parameter, where ID is the ID of the **IIDK Interface** in the system.

```
CORE||GET_CONFIG|objtype<CAM>,objid<1>,receiver_id<1>
```

**// Returns the parameters of the Camera 1 object**

To get the user ID and user's permissions DI by username and password, use the CHECK\_USER function. Examples of using:

```
CORE||CHECK_USER|password<1>,login<1>
```

```
CORE||CHECK_USER|pass_key<1373503546>,login<1> (crc32 from DB)
```

```
CORE||CHECK_USER|md5<bf03b1605e3c83978514f2a6546eef50> (md5 from DB)
```

Response:

```
ACTIVEX|1|USER_RIGHTS|rights_id<1>,user_id<1>
```

If the password is incorrect, the response comes with a delay of 1 second.

## Determining Computers Where Axxon PSIM was Unloaded (via Port 1030)

If *Axxon PSIM* is unloaded, the callback function receives a message with an **action** parameter value of

**DISCONNECTED:**

```
ACTIVEX|12|EVENT|SOCKET<>,MMF<>,objaction<DISCONNECTED>,TRANSPORT_TYPE<MMF>,core_global<1>,
action<DISCONNECTED>,module<psim_host.exe>,objtype<SLAVE>,_slave_id<SLAVAXP.12>,
objid<SLAVAXP>,owner<SLAVAXP>,TRANSPORT_ID<1111>,time<12:41:16>,date<23-09-02>
```

The message contains the name of the computer on which *Axxon PSIM* was unloaded and the date and time.

## Redirecting Video Cameras to the Monitor

After receiving the following message, the system deletes all cameras from the monitor and calls the specified video camera:

```
CORE||DO_REACT|source_type<MONITOR>,source_id<1>,action<REPLACE>,params<4>,param0_name<SLAVE_id>,param0_val<SLAVA>,param1_name<cam>,param1_val<1>,param2_name<control>,param2_val<1>,param3_name<name>,param3_val<>
```

If connected via port 900, the above action is performed by using the following message:

```
MONITOR|1|REPLACE|SLAVE_id<SLAVA>,cam<1>,control<1>
```

## Obtaining Object Parameters (via Port 1030 ) GET\_CONFIG

An example of use of the **GET\_CONFIG** command is given below:

```
CORE||GET_CONFIG|objtype<CAM>,objid<1>
```

The returned message contains all the parameters of the specified object:

```
ACTIVEX|12|OBJECT_CONFIG|
rec_priority<0>,mask0<>,decoder<0>,mask1<>,flags<>,mask2<>,compression<3>,sat_u<5>,mask3<>,proc_time<>,
hot_rec_period<>,mask4<>,telemetry_id<>,manual<1>,region_id
<1.1>,contrast<5>,md_mode<0>,md_size<5>,audio_type<>,pre_rec_time<0>,config_id<>,
bright<7>,alarm_rec<0>,
audio_id<>,rec_time<>,hot_rec_time<2>,activity<>,mux<0>,parent_id<1>,objtype<CAM>,type<>,__SLAVE_id
<SLAVEXP.12>,objid<1>,
name<Camera 1>,objname<Camera 1>,color<1>,priority<0>,md_contrast<5>
```

### Note:

To obtain the configuration of all the objects of the specified type, remove the **objid** parameter.

Example. Get information about user by the identifier.

```
CORE||GET_CONFIG|objtype<PERSON>,objid<1>
```

The response is the message with parameters containing necessary information, including user name, card number etc.:

```
ACTIVEX|1|OBJECT_CONFIG|
pnet3_sound<0>,galaxy_dual_focus<0>,auto_pass_type<>,galaxy_pin_change<0>,external_id<>,card_date<26.05.
2017
10:57:06>,galaxy_tag_link<0>,rubeg8_zone_id<>,levels_times<>,expired<>,hid_escort_id<>,objtype<PERSON>,leve
l2_id<>,galaxy_group_choice<0>,
who_level<>,hid_use_extended_access<0>,visit_purpose<>,card<1234>
,email<>,galaxy_timer_schedule<0>,galaxy_menu_option<0>,aiu_holiday<0>,
area_id<>,aiu_alarm<0>,objname<User 1>,surname<>,who_card<>,auto_brand<>,pnet3_alarm<0>,card_loss<0>,
facility_code<432>
,galaxy_temp_code<0>,post<>,when_area_id_changed<>,drivers_licence<>,bolid_in_device<0>,pnet3_acs_counte
r<0>,
temp_levels_times<>,temp_card<>,pnet3_no_entry<0>,location<>,temp_level_id<>,patronymic<>,teleph_work<>,
department<>,galaxy_keypad<0>,
__TRANSPORT_ID<>,finished_at<>,aiu_ksd_type<>,all_param_id<>,galaxy_template<0>,tabnum<>,parent_id<1>,pur<>
,galaxy_duress<0>,pnet3_no_exit<0>,
galaxy_dual<0>,hid_pin_exempt<0>,pnet3_counter<0>,whence<>,schedule_id<>,hid_enable_pin_commands<0>,g
alaxy_dual_access<0>,
pnet3_block<0>,passport<>,person<>,galaxy_menu_choice<0>,flags<0>,auto_number<>,phone<>,pin<>,rubeg8_A
ccessToBCPTimeZoneNumber<>
```

```
begin_temp_level<>,pnet3_master<0>,aiu_mark<0>,end_temp_level<>,visit_birthplace<>,galaxy_menu_level<>,vi
sit_document<>,pnet3_guard<0>,
pnet3_black<0>,aiu_kso_type<>,is_apb<0>,name<User 1>,pnet3_temp<0>,started_at<>,level_id<>,_marker<>,
bolid_user_type<>,owner_person_id<>,card_type<>,is_active_temp_level<0>,begin<>,hid_line_tag<>,guid<{5B358
685-E041-E711-BCC6-DA0AE28E0C17}>,
pnet3_guest<0>,is_locked<0>,objid<1>,marketing_info<>,comment<>,aiu_vpu_arm<0>,visit_reg<>,bolid_in_pku<0
>,pnet3_2cards_mask<0>
```

**Note.**

User data can also be received via direct request to *Axxon PSIM* software database from the OBJ\_PERSON table. In this case you can select a user by card number or other parameters. See more info on *Axxon PSIM* software database operation in Administrator's Guide, the [Appendix 4. Axxon PSIM™ software database management](#).

## Obtaining Information on Object States GET\_STATE and GET\_LIST

To obtain information on the state of an object, use the **GET\_STATE** command:

**CORE||GET\_STATE|objtype<CAM>,objid<1>**

The following string is returned:

**ACTIVEVX|12|OBJECT\_STATE|objtype<CAM>,\_SLAVE\_id<SLAVAXP.12>,objid<1>,state<DISARM\_DETACHED>**

The state of the specified object is represented by the **state** parameter, which takes values from the set of states that are specified in the object's DDI file.

If connected via port 900, requests for object states are performed through the **GET\_LIST** command:

**CAM||GET\_LIST**

**Note:**

Regardless of whether an object ID is specified, the command returns the states of all objects of the specified type.

The returned message has the following format:

**CAM|1|SETUP|rec\_priority<0>,is\_armed<0>,is\_recorded<0>, bt<0> , SLAVE\_id<SLAVAXP>,  
compression<3>,sat\_u<5>, proc\_time<0>, hot\_rec\_period<0> , manual<1>, telemetry\_id<>, is\_detached<1> ,  
contrast<5>, md\_size<5>,md\_mode<0>, is\_alarmed<0>, audio\_type<>, pre\_rec\_time<0>, bright<7>,  
audio\_id<>, rec\_time<0>, alarm\_rec<0>, hot\_rec\_time<2>, mux<0>, parent\_id<1>, \_\_SLAVE\_id<SLAVAXP>,  
priority<0>, mask<>, color<1>,md\_contrast<5>, is\_ring<1>, fs\_error<0>**

The message presents the states as follows: **is\_state<val>**, where **state** is an object state (see the DDI file); and **val** equals 1 if the object is in this state, 0 otherwise.

**Note.**

The **is\_ring<>** parameter shows whether loop recording is performing or not. The **fs\_error** parameter equals 1 when there was an archive recording error (e.g. failed to delete folder for loop recording).

## Showing Information Messages. SET\_STATE

To show an information message on the display of Axxon PSIM's main control panel, use the SET\_STATE command:

**CORE||SET\_STATE|name<POS 1>,value<Can't open port COM4>**

The figure below shows the result of handling the message by the system.

The message is removed from the display as follows:

**CORE||SET\_STATE|name<POS 1>,value<>**

## Live and archived video

Get live video

To get live video from Camera 1 send the following message to port 900:

**CAM|1|START\_VIDEO|compress<1>**

Here compress<> is compression ratio, from 0 to 5. Video frames will be received as a response to this message. The example of how to process incoming frames is given in Demo kit available for download at the page of [Axxon PSIM Software Integration Guide \(HTTP API, IIDK, ActiveX\)](#).

Get archived video

To get archived video from Camera 1 send the following messages to port 900:

**CAM|1|ARCH\_FRAME\_TIME|time<dd-mm-yy HH:MM:SS.FFF>** (to specify start time for viewing the archive) or  
**CAM|1|PLAY|compress<>** (to get archived video. Archived video is handled the same way as live video)

Get the list of time intervals

In order to get the full list of time intervals with video recordings for exact date, send the following message to port 900:

**CAM|id|ARCH\_GET\_INTERVALSREC|date<>,time\_with\_milliseconds<1>,with\_filenames<1>**

The date<> parameter can take the date<dd-mm-yy> value or it can be left blank. In the first case, the intervals for the specified date will be requested, in the second case, the dates for which the archive is present will be requested.

If the time\_with\_milliseconds<1> parameter is set, then the intervals will be received with milliseconds (for example, 14:08:55.**677** 14:09:55.**641**). If the with\_filenames<1> parameter is set, then the message will contain filenames (for example, 'C:\VIDEO\26-04-21 14\0\_01'). These parameters are optional.

As a result the following message is received:

**Event: CAM|id|SET\_INTERVALSREC|intervals<>,date<>,timezone<>**

The value of intervals<> parameter looks like this: intervals<begin1 end1\nbegin2 end2...\nbeginN endN|  
date1\ndate2...\ndateN\n>

The time of beginning and ending are one blank separated (0x20 code), intervals are line break separated ('\\n'(0x0A code)).

- begin1, begin2, ... beginN – time of interval beginnings in the HH:MM:SS format (returns if the exact date was requested).
- end1, end2, ... endN – time of interval endings in the HH:MM:SS format (returns if the exact date was requested).
- date1, date2, ... dateN – dates at which there are recordings in the archive (returns if the date field in the request is blank or there is no such field).

date<dd-mm-yy> parameter represents date for which the intervals were requested or blank value (date<>) if dates for the entire period were requested.

timezone<> shows time shift on the client (IIDK) relative to Server time, in minutes. Examples:

- If Server is in -1 UTC time zone, the response to the CAM|1|ARCH\_GET\_INTERVALSREC| command will have parameter timezone<60>
- If Server is in +3 UTC time zone, the response to the CAM|1|ARCH\_GET\_INTERVALSREC| command will have parameter timezone<-180>

Request example:

```
CAM|1|ARCH_GET_INTERVALSREC|date<26-04-21>,time_with_milliseconds<1>,with_filenames<1>
```

Response example:

```
CAM|1|SET_INTERVALSREC|time_with_milliseconds<1>,intervals<14:07:55.659 14:08:55.637
- - file:'C:\VIDEO\26-04-21 14\0._01'
14:08:55.677 14:09:55.641 - - file:'C:\VIDEO\26-04-21 14\1._01'
14:09:55.681 14:10:35.667 - - file:'C:\VIDEO\26-04-21 14\2._01'
14:17:12.444 14:18:09.553 - - file:'C:\VIDEO\26-04-21 14\3._01'
14:29:41.132 14:29:41.292 - - file:'C:\VIDEO\26-04-21 14\4._01'
14:29:41.432 14:29:51.363 - - file:'C:\VIDEO\26-04-21 14\5._01'
14:34:38.788 14:35:03.117 - - file:'C:\VIDEO\26-04-21 14\6._01'
14:35:03.267 14:36:19.151 - - file:'C:\VIDEO\26-04-21 14\7._01'
>,timezone<-180>,module<iidk_client_test_x64.exe>,_TRANSPORT_ID<>,with_filenames<1
>,date<26-04-21>,SLAVE_id<VDESKTOP.2A180FE5-BA8E-420C-B80E-90DC20516A26>,durationMS<0>
```

## Telemetry control via IIDK

Telemetry is controlled via IIDK using simple reactions described in the TELEMETRY section of Programming guide, for instance:

### CORE||DO\_REACT|

**source\_type<TELEMETRY>,source\_id<1.1>,action<LEFT>,params<1>,param0\_name<tel\_prior>,param0\_val<3>** – message sent to port 1030 in order to rotate camera lens left with high priority.

**TELEMETRY|1.1|LEFT|speed<2>,tel\_prior<3>** – reaction to port 1030 in order to rotate camera lens left with high priority at an average speed.

## Map layer operations

The command for setting the parameter and position of **Camera 1** object icon is run in one of the following ways:

1. Sending a message to port 1030

```
CORE| |DO_REACT|source_type<MAPLAYER>,source_id<1>,action<CUSTOMIZE_OBJECT>,para
ms<7>,param0_name<x>,param0_val<200>,param1_name<y>,param1_val<200
>,param2_name<objtype>,param2_val<CAM>,param3_name<objid>,param3_val<1
>,param4_name<a>,param4_val<90>,param5_name<w>,param5_val<70
>,param6_name<h>,param6_val<80>
```

Where  $x$ ,  $y$ ,  $w$  and  $h$  are the coordinates and size of the object icon on the map.

$a$  is a tilt angle of icon.

2. Sending a reaction to port 1030

**MAPLAYER|1|CUSTOMIZE\_OBJECT|x<200>,y<200>,objtype<CAM>,objid<1>,a<90>,w<70>,h<80>**

Layer 1 is shown in the interactive map window using one of the following ways:

1. Sending a message to port 1030: **CORE||DO\_REACT|source\_type<MAPLAYER>,source\_id<1>,action<ACTIVATE>**
2. Sending a reaction to port 1030: **MAPLAYER|1|ACTIVATE**

## Obtaining info on core queues with GET\_QUEUE\_INFO command

Use the GET\_QUEUE\_INFO command to request info about the queues in the *Axxon PSIM* core:

### CORE||GET\_QUEUE\_INFO

#### Note.

The receiver\_id parameter may be specified if there are several **IIDK Interface** objects in the system – see [Working with the System in the Multiuser Mode](#).

The response is the string like this:

```
ACTIVEX|11|QUEUE_INFO|
thread2<0>,thread1<0>,thread0<0>,posted_events<0>,_TRANSPORT_ID<>,server_reacts<0>,
posted_reacts<0>,events_inwork<0>,coremanager_events<0>,thread3<0>
```

The response parameters correspond to the information displayed in the **Queue statistics** tool (shows on Alt+F2). Parameters description:

**threadN<>** – number of items in the queue of the thread N.

**posted\_events<>** – number of incoming events.

**posted\_reacts<>** – number of reactions currently being processed.

**coremanager\_events<>** – number of events to send.

**server\_reacts<>** – number of reactions to send.

**events\_inwork<>** – number of events currently being processed.

## Playing audio archive for a period. START\_PLAY\_TIME command

To play the audio archive of a specified microphone for a specified period using a specific **Speaker** object, execute a command like

```
SPEAKER|{id}|START_PLAY_TIME|speaker_id<>,mic_id<>,time_start<>,time_end<>,cam_id<>
```

Examples:

```
SPEAKER|1|START_PLAY_TIME|speaker_id<1>,mic_id<2>,time_start<28-02-20
14:23:24.092>,time_end<28-02-20 14:23:27.092>
```

```
SPEAKER|1|START_PLAY_TIME|speaker_id<1>,mic_id<2>,time_start<02-03-20
12:01:24.092>,time_end<02-03-20 12:04:27.092>,cam_id<1>
```

If camera ID **cam\_id<>** is specified, the audio archive recorded synchronously with the video archive (i.e. from the VIDEO folder) will be played. If the **cam\_id<>** parameter is not specified, then the archive from the AUDIO folder is played.

**speaker\_id<>** – identifier of the **Speaker** object

**mic\_id<>** – identifier of the **Microphone** object

**time\_start<>** – start time of the audio archive segment

**time\_end<>** – end time of the audio archive segment

## Playback of the dial tone. The START\_TONE and STOP\_TONE commands

To playback the numbers, letters, and symbols in a dial tone using a specific **Speaker** object, run the START\_TONE command:

```
SPEAKER|{id}|START_TONE|speaker_id<>,symbols<>,duration<>
```

Command parameters:

- **speaker\_id<>**—identifier of the Speaker object on which you want to perform the playback;
- **symbols<>**—symbols that should be played back. Only 1234567890\*#ABCD can be symbols, others will be ignored. The letter case doesn't matter;
- **duration<>**—duration of sounding of each symbol in milliseconds (ms).

To stop the playback early, run the STOP\_TONE command:

```
SPEAKER|{id}|STOP_TONE|speaker_id<>
```

Here, **speaker\_id<>**—identifier of the Speaker object on which you want to stop the playback.

Command examples:

```
SPEAKER|1|START_TONE|speaker_id<1>,symbols<12>,duration<200>
SPEAKER|1|STOP_TONE|speaker_id<1>
```

## 12 CamMonitor.ocx ActiveX Control

### 12.1 General description of CamMonitor.ocx component of ActiveX

#### On the page:

- [General information](#)
- [Requirements to developers](#)

#### 12.1.1 General information

CamMonitor.ocx is the component of ActiveX that is similar in every way to the **Video monitor** interface object. It allows you to manage cameras, view the archive, etc.

CamMonitor.ocx component supports operation in the *Axxon PSIM* Demo mode.

#### 12.1.2 Requirements to developers

To use CamMonitor.ocx you will need:

1. The knowledge of any programming language that supports using the Component Object Model (COM);
2. Basic knowledge of Win32/Win64 programming;
3. Programming environment that supports OCX files.

✔ [Requirements for software which is used while integrating](#)

### 12.2 How to install CamMonitor.ocx

#### ⚠ Important!

It is not recommended to install *Axxon PSIM* and CamMonitor.ocx on the same computer. If it is required, then their versions are to be the same, otherwise CamMonitor.ocx operation is not guaranteed.

Use the CamMonitorInstaller.exe file (stored in the <Axxon PSIM installation directory>\Redist\CamMonitor folder) to install CamMonitor.ocx. Both 32-bit and 64-bit versions of this component are available. The installation files of components of different bit count are stored in the corresponding folders (x86 and x32 correspondingly).

If *Axxon PSIM* software is installed on the computer, then the CamMonitor.ocx file is stored in the <Axxon PSIM installation directory>\Modules\ folder when installing the 32-bit version and it is stored in the <Axxon PSIM installation directory>\Modules64\ folder when installing the 64-bit version.

If *Axxon PSIM* software is not installed, then the 32-bit component is installed in the c:\Program Files (x86)\AxxonSoft VideoPlayer\Modules\ folder and the 64-bit component is installed in the c:\Program Files\AxxonSoft VideoPlayer x64\Modules64\ folder.

There is standard registration of CamMonitor.ocx as ActiveX component at the stage of installation.

CamMonitorInstaller.exe installs the required files for all users.

Besides the library itself, CodecPack driver pack and AxxonSoft VideoPlayer utility are installed. AxxonSoft VideoPlayer utility uses the CamMonitor.ocx component and enables viewing the archive from the selected camera. By default this utility is installed in the C:\Program Files\AxxonSoft VideoPlayer\ folder. The utility interface looks like one of Converter.exe, but some features of Converter.exe (not dealing with viewing the archive) are not available. This utility can be used to check if CamMonitor.ocx is installed correctly.

## 12.3 CamMonitor.ocx parameters

**On the page:**

- [CamMenuOptions](#)
- [CamMenuProcessingOptions](#)
- [CamButtonsOptions](#)
- [MainPanelOptions](#)
- [KeysOptions](#)
- [OverlayMode](#)
- [How to use parameters](#)

The parameters used for setting the CamMonitor component are presented in this section: set the display elements of the interface, as well as the overlay mode.

All parameters are *long* integers.

The values of the parameters used for interface setup are listed in the tables and formed in a way that there is only one unit in the binary representation of the number. To set the value of a parameter, combine the values of parameters using the XOR operation. You'll get the number the positions of which in binary representation indicates which interface elements should be displayed and which should be hidden. See [How to use parameters](#).

The OverlayMode parameter differs from others: it takes values from 0 to 2, and its value sets the overlay mode.

### 12.3.1 CamMenuOptions

**CamMenuOptions** : long

Allows setting the feature menu of the camera.

One or more checkboxes can be set.

Available values:

Value	Information
#define MENU_ENABLE_OPTION 0x00000001	Deprecated. See BUTTON_MENU_ENABLE_OPTION

#define MENU_ARM_ENABLE_OPTION 0x00000002	Show the <b>Arm</b> option
#define MENU_REC_ENABLE_OPTION 0x00000004	Show the <b>Start recording</b> option
#define MENU_CAMS_ENABLE_OPTION 0x00000008	Show the <b>Camera</b> option
#define MENU_TITLES_ENABLE_OPTION 0x00000010	Show the <b>Show titles</b> option
#define MENU_PROCESSING_ENABLE_OPTION 0x00000020	Show the <b>Processing</b> option
#define MENU_EXPORT_ENABLE_OPTION 0x00000040	Show the <b>Export</b> option

### 12.3.2 CamMenuProcessingOptions

**CamMenuProcessingOptions** : long

Allows setting the **Processing** menu in the feature menu of the camera.

One or more checkboxes can be set.

Available values:

Value	Information
#define MENU_PROCESSING_DEINTERLACE_ENABLE_OPTION 0x00000001	Show the <b>Deinterlacing</b> option
#define MENU_PROCESSING_ZOOM_ENABLE_OPTION 0x00000002	Show the <b>Zoom-in</b> option <i>Note. If this option is disabled, the <b>Processing</b> → <b>Zoom</b> menu item is not shown, but zooming with mouse wheel is still available</i>
#define MENU_PROCESSING_CONTRAST_ENABLE_OPTION 0x00000004	Show the <b>Contrast</b> option
#define MENU_PROCESSING_MASK_ENABLE_OPTION 0x00000008	Show the <b>Detector mask</b> option
#define MENU_PROCESSING_SHARP_ENABLE_OPTION 0x00000010	Show the <b>Sharpen</b> option

### 12.3.3 CamButtonsOptions

**CamButtonsOptions** : long

Allows setting the display of the CamMonitor component buttons.

One or more checkboxes can be set.

Available values:

Value	Information
#define BUTTON_MODE_ENABLE_OPTION 0x00000100	Show the Archive button
#define BUTTON_TIME_ENABLE_OPTION 0x00000002	Show time
#define BUTTON_NAME_ENABLE_OPTION 0x00000004	Show camera name
#define BUTTON_MENU_ENABLE_OPTION 0x00000008	Show the Menu button
#define BUTTON_RAYS_ENABLE_OPTION 0x00000010	Not used
#define BUTTON_MICS_ENABLE_OPTION 0x00000020	Not used
#define BUTTON_ARCH_PANEL_ENABLE_OPTION 0x00000200	Show the archive navigation elements

### 12.3.4 MainPanelOptions

**MainPanelOptions** : long

Allows setting the display of the CamMonitor panel.

One or more checkboxes can be set.

Available values:

Value	Information
#define MAIN_PANEL_ENABLE_OPTION 0x00000001	Show the panel
#define MAIN_PANEL_ENABLE_SCREEN_BUTTON 0x00000010	Show the <b>Screens</b> button (see <a href="#">Windows layout on the monitor</a> )
#define MAIN_PANEL_ENABLE_BOOKMARK_BUTTON 0x00000020	Show the <b>Create a bookmark</b> button (see <a href="#">Create a bookmark</a> )
#define MAIN_PANEL_ENABLE_BOOKMARK_REVIEW_BUTTON 0x00000040	Show the <b>List of bookmarks</b> button (see <a href="#">List of bookmarks</a> )

#define MAIN_PANEL_ENABLE_AVIEXPORT_BUTTON 0x00000080	Show the <b>Background export</b> button (see <a href="#">The AviExport utility</a> )
--	---

### 12.3.5 KeysOptions

**KeysOptions** : long

Allows setting the control over the component using the keyboard and the mouse.

One or more checkboxes can be set.

Available values:

Value	Description
#define KEYS_ENABLE_OPTION 0x00000001	Enables control over the CamMonitor component using the hotkeys available for Video Monitor (see <a href="#">Video surveillance monitor</a> )
#define TELEMETRY_DISABLE_OPTION 0x00000002	Disables Telemetry control using the CamMonitor component (see <a href="#">Telemetry control</a> )
#define ARCH_DELETE_ENABLE_OPTION	Enables archive recordings deletion from the recordings list (see <a href="#">Deleting video recordings from the archive</a> )
#define ARCH_PROTECT_ENABLE_OPTION	Enables rewrite protection of the archive recordings from the recordings list (see <a href="#">Protection of separate record and disable of protection</a> )

### 12.3.6 OverlayMode

**OverlayMode** : long

Sets the overlay mode.

Available values:

Value	Information
0	Overlay is not in use
1	Overlay 1
2	Overlay 2

## 12.3.7 How to use parameters

```
DWORD options = CamMonitor1->CamMenuOptions;
options =
options^MENU_CAMS_ENABLE_OPTION^MENU_ARM_ENABLE_OPTION^MENU_REC_ENABLE_OPTION;
CamMonitor1->CamMenuOptions = options;
CamMonitor1->CamMenuProcessingOptions ^= MENU_PROCESSING_MASK_ENABLE_OPTION;
```

## 12.4 CamMonitor.ocx methods

### On the page:

- [Connect](#)
- [ShowCam](#)
- [DoReactMonito  
r](#)
- [RemoveAllCam  
s](#)
- [IsConnected](#)
- [GetCurlp](#)
- [SendRawMessa  
ge](#)
- [Disconnect](#)
- [SetCallBackOpt  
ions](#)
- [SetParam](#)

### 12.4.1 Connect

**Connect**(BSTR **ip**, BSTR **login**, BSTR **password**, BSTR **arch\_password**, long **param**, long **port**) set up a connection to the Server/Video Gate/Backup Archive.

- BSTR **ip** – IP address of the Video server;
- BSTR **login** – login to connect to the Server (can be blank);
- BSTR **password** – password to set up a connection to the Video server (can be blank);
- BSTR **arch\_password** – password to access the archive (i.e. admin password, can be blank);
- long **param** – Server role. The parameter is mandatory.
  - 0 – video server;
  - 1 – backup archive;
  - 2 – videogate;
- long **port** – port to connect Video server.
  - if 0, 1 or 2 are passed, the connection is established with port 900, 901 or 902 correspondingly;
  - if 100 is passed, the connection is with port 10504;
  - if any other value passed, the connection is with port number "port + 20000". For example, if port=900, the connection is established with server port 20900.

The connection to Server is set up **asynchronously**.

**⚠ Important!**

If login and password are not specified at Connect() method call, all cameras are viewable in the control. It is to be considered when developing third-party application if access privileges are relevant.

## 12.4.2 ShowCam

**ShowCam**(long **cam\_id**, long **compress**, long **show**) shows/hides camera on the monitor.

- long **cam\_id** – camera ID
- long **compress** – level of video compression 0-5 (for local camera =0). If set to -1, video stream is displayed directly from the camera without compression
- long **show** – checkbox: show/hide camera (1/0)

## 12.4.3 DoReactMonitor

**DoReactMonitor**(BSTR **react\_string**) – control over the monitor/cameras

- BSTR **react\_string** – reaction string view

**How to create react\_string:**

```
react_string = "MONITOR| |ARCH_FRAME_TIME|cam<3>,date<dd-mm-yy>,time<hh:mm:ss>";
CamMonitor1->DoReactMonitor(react_string);
```

**The result of calling the function with the parameter:** camera 3 will be in the archive mode and the archive will be positioned to date «dd-mm-yy» and time «hh:mm:ss» (date and time are to be set in this format only).

The mode parameter takes the following values:

0 – video gate if it's specified (otherwise, video server).

1 – video server.

2 – long-time archive.

“MONITOR|<id ignored>|ARCH\_FRAME\_TIME|...”

**i Note:**

Positioning accuracy can be specified in milliseconds, for instance:

```
DoReactMonitor("MONITOR| |ARCH_FRAME_TIME|cam<3>,date<02-10-05>,time<12:12:22.345>
```

**Example.** Show 2nd stream from camera 14 on Monitor 1:

```
"MONITOR|1|ADD_CAM|cam<14>,cam_id<14>,compress<1>,stream_id<14.2>"
```

**Exapmle.** Set fps = 1 when viewing archive from Camera 11

```
"MONITOR||CAM_PARAMS|cam<11>;arch_fps<1>"
```

### 12.4.4 RemoveAllCams

**RemoveAllCams() : long** – remove all cameras from the monitor

### 12.4.5 IsConnected

**IsConnected() : boolean** – method shows if the Video server is connected or disconnected

### 12.4.6 GetCurlp

**GetCurlp() : BSTR** – returns the IP address of Server specified when calling **Connect**

### 12.4.7 SendRawMessage

**SendRawMessage(BSTR msg)** – sends the command to be executed to Video server

- BSTR **msg** – command string view

**How to call a function:**

```
m_Cam.SendRawMessage("CAM|1|REC");
```

```
m_Cam.SendRawMessage("CAM|1|REC_STOP");
```

```
m_Cam.SendRawMessage("CAM|1|ARM");
```

```
m_Cam.SendRawMessage("CAM|1|DISARM");
```

### 12.4.8 Disconnect

**Disconnect()** – disconnect from the Video server.

### 12.4.9 SetCallbackOptions

**SetCallbackOptions(int cam\_id, int options)** – sets parameters of getting video from camera.

- int **cam\_id** – camera ID (number).
- int **options** – options. The possible values of the **options parameter are:**
  - WithoutVideoFrame = 0x00 – do not send frames from the video module.
  - WithVideoFrame = 0x01 – send frames from the video module.
  - WithExtendedParams = 0x02 – get frames with extended parameters (time, fps, subtitles).
  - WithInformationLayout = 0x04 – display video in the window with control elements (context menu).
  - WithCompressedData = 0x08 – display video in the native format without decompression (if any).
  - WithoutDecode = 0x10 – disable video decoding on the server.
  - WithoutSubtitles=0x20 – disable subtitles.

**Note**

The options parameter is created the same as parameters of the CamMonitor.ocx component – see [CamMonitor.ocx parameters](#).

### 12.4.10 SetParam

SetParam(BSTR **param\_name**, BSTR **param\_value**) – sets the number of camera windows in CamMonitor.

- BSTR **param\_name** – a string representation of the length or width.
- BSTR **param\_value** – the number of camera windows.

**How to call a function:**

```
m_cam.SetParam("monitor_ch", m_NH);
m_cam.SetParam("monitor_cw", m_NW);
```

## 12.5 CamMonitor.ocx events

**OnCamListChange** (long **cam\_id**, long **action**) – occurs when there is connection with the Server or the number of cameras on the Server changes.

- long **cam\_id** – camera ID.
- long **action** equals 1, if camera with **id == cam\_id** exists, otherwise **action == 0**.

This event occurs as many times as there are cameras on the Server. The negative value of the **cam\_id** parameter (**cam\_id < 0**) shows that **OnCamListChange** is not called.

If there are 3 cameras (1, 2, 3) on the Server, then the following events will occur one after another:

CamListChange(1,1)

CamListChange(2,1)

CamListChange(3,1)

CamListChange(-1,1)

**Example:**

Show the camera with **cam\_id=2** with **compress=1** compression level;

```
CamMonitor1CamListChange(long cam_id, long action)
{
    if(cam_id == -1)
    {
        CamMonitor1->ShowCam(2,1,1);
    }
}
```

## 13 Axxon PSIM HTTP API

### 13.1 Calling API of vertical solutions via Axxon PSIM HTTP API

The *Axxon PSIM* HTTP API allows you to access the [Face PSIM. REST API](#) or [Auto PSIM. REST API](#) via Web Server 2.0. To use this feature, you need the following:

- *Face PSIM* REST API:
  - The **Face Recognition Server** object must be added to the Web server 2.0 filter (see [Configuring the Events filter for the Web server 2.0 module](#)).
  - The response to the request for the list of objects must contain an object FIRSERVER type (see [Getting list of all server objects](#)).
- *Auto PSIM* REST API:
  - The **LPR channel** object must be added to the Web server 2.0 filter (see [Configuring the Events filter for the Web server 2.0 module](#)).
  - The response to a request for a list of objects must contain an object of the ULPR type (see [Getting list of all server objects](#)).

#### 13.1.1 General request format

POST http://IP address:port/web2/secure/{vertical\_solution}/{function}

#### 13.1.2 Request parameters

Parameter	Is required	Description
vertical_solution	Yes	Specifies the vertical solution to access the API. Possible values: <i>auto</i> – <i>Auto PSIM</i> <i>face</i> – <i>Face PSIM</i>  If <b>face</b> value is specified, then it is necessary to send the id of the Face Recognition Server to <i>Face PSIM</i> both in the URL and in the request body:  POST http://IP-address:port/web2/secure/face/{server_id}/{function}
function	Yes	Vertical solution API function. See the description of the corresponding API

**Note.**

Please refer to the documentation for the corresponding API function to see the parameters of the JSON sent in the POST request.

### 13.1.3 Request examples

POST http://1:1@127.0.0.1:8085/web2/secure/face/1/firserver/ReadPersons

```
{ "server_id": "1", "objectType": "PERSON", "id": [], "page": 1, "pageSize": 2 }
```

GET http://1:1@127.0.0.1:8085/web2/secure/lprserver/GetImage/Frames/66FB34A2-1B38-E811-A92F-001A7DDA710E

### 13.1.4 Response examples

Please refer to the documentation for the corresponding vertical solution API for the response examples.

## 13.2 General information on HTTP API

HTTP API is represented by web2 module (*Web-server 2.0*).

#### **Note.**

See [Administrator's Guide, Configuring the server for the clients connection via the Web server 2.0 module](#) section.

HTTP API allows the following features:

1. Get information about interactive maps: map list, map name, map layer list, layer parameters, layer background image, information about the list of points and an individual point on the layer (see [Map](#)).
2. Get information about object classes created on the Server, a list of states for the object class and information about status, icons for a specific state (see [Object classes](#)).
3. Get a list of objects created on the server, information about the individual object, the state of the object, the list of available actions with the object (see [Objects](#)).
4. Receive events from the Server both separately and by blocks (see [Getting events](#)).
5. Send commands to the server (see [Sending commands to server](#)).
6. Run macros (see [Macros](#)).
7. Work with video: get frames, request configuration, receive live and archive video, manage recording, arm and disarm cameras, manage telemetry (see [Video](#)).
8. Get live and archive sound (see [Sound](#)).
9. Send events and reactions to the core of the Axxon PSIM software (see [Sending reactions and events to Axxon PSIM using HTTP request](#)).

The following notation is used in the examples shown in this section:

- Port stands for port number. The default **Web-server 2.0** module port is 8085. Specifying port in HTTP API commands is mandatory.
- /web2 – web context where the web2 app operates. This is the web-app context.

Further the description will be omitted when query action is clear in the context.

#### **Important!**

URL, id of objects and file extension are case-sensitive.

#### **Note.**

Date and time are specified in RFC 3339 format, see details at <http://www.ietf.org/rfc/rfc3339.txt>

### 13.2.1 Authorization

Authorization is needed for requests. Two types of authorization are supported: Basic and Bearer.

With the Basic authorization type, it is necessary to add user data to all HTTP requests in the following form:

```
http://[username]:[password]@[IP-address]:[port]/web2
```

With the Bearer authorization type, the token received from the web server is used (see [Authorization using a token key](#)).

### 13.2.2 Default response format

By default, the response is in the JSON format. The default response in XML format can be enabled on the settings panel of the **Web server 2.0** object (see [Configuring default response type for HTTP API requests](#)). Also, the response format can be explicitly specified in the **Accept** header, for example **application/json** or **application/xml**. The response format specified in the request has a higher priority than the default response format specified on the settings panel of the **Web server 2.0** object.

### 13.2.3 Cross domain requests (CORS)

To perform cross-domain requests or to access the necessary headers in the response (for example, due to CORS browser policy restrictions), it is necessary to specify **Origin** (the domain of the site from which the request is made) in the request header. In this case, the response will contain the **Access-Control-Allow-Origin** header, which indicates that the resource can be accessed from the specified domain in a cross-site manner. The **Access-Control-Allow-Origin: \*** header indicates that the resource can be accessed from any domain in a cross-site manner.

## 13.3 Product version

### 13.3.1 General request format:

```
http://IP-address:port/web2/product/version
```

### 13.3.2 Request example:

```
GET http://127.0.0.1:8085/web2/product/version
```

### 13.3.3 Response example:

The response is text/plain line like:

```
Axxon PSIM/1.0.2875
```

It means that the server supports the protocol described in this document. The line can change depending on the product version. This helps to distinguish 2 web servers with similar functionality but different protocols in different products.

## 13.4 Authorization using a token key

Authorization in *Axxon PSIM* using a token key provides the following capabilities:

- To specify a token in the "token" parameter in a url request instead of specifying the "login" and "password" parameters.

Example of a video request with authorization in *Axxon PSIM* using a token key:

```
http://127.0.0.1:80/video/action.do?
normalize=true&version=4.10.0.0&video_in=CAM:1&token=EoHWC_zXFILImB0hL4QgjPc562
4cJXMF
```

- To use the Bearer Token Authentication in the "Authorization" parameter in the request header.

Example:

```
Authorization: Bearer PJ_eHSwUsqjXX7PRZMB8hm_zKEnCg3hE"
```

### 13.4.1 General format of request:

GET/POST http://{login}:{password}@IP-address:port/token?expires\_in={expires\_in}

### 13.4.2 Request parameters:

Parameter	Is required	Description
login	No	User login in <i>Axxon PSIM</i> , if specified
password	No	User password in <i>Axxon PSIM</i> , if specified
expires_in	No	Token validity time in seconds. The maximum value is 1 day. The token expires after a specified period of time.  The default value is <b>1800</b> .  To log out, specify the value <b>0</b> .  <i>Note. There can be only 1 token for each user.</i>

### 13.4.3 Request example:

GET/POST http://USER:PASSWORD@127.0.0.1:80/token?expires\_in=1800

### 13.4.4 Response example:

```
{
"access_token": "PJ_eHSwUsqjXX7PRZMB8hm_zKEnCg3hE"
"token_type": "bearer"
```

```
"expires_in":"1800"
}
```

### 13.4.5 Response parameters:

Parameter	Description
access_token	Token
token_type	Token type
expires_in	Token validity time in seconds

## 13.5 Maps

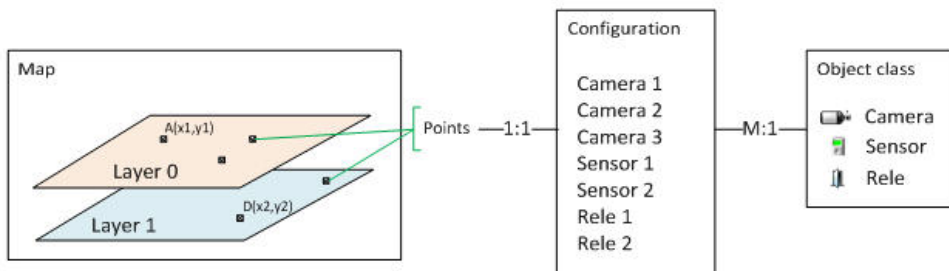

Several maps can be created on the server. Each map can consists of one or more layers. There are points on each layer. Each point corresponds to one of the objects in configuration.

Configuration – objects in *Axxon PSIM*. Each object represents the object of specific class. Each object has one state and the list of actions to be performed.

The object class describes its icons, possible states and possible actions with the object in each state.

### 13.5.1 Getting the list of maps

General request format:

GET <http://IP-address:port/web2/secure/kartas/>

Request example:

GET <http://127.0.0.1:8085/web2/secure/kartas/>

**Response example:**

```
<kartas>
```

```

<karta>
  <id>2</id>
  <layers>
    <layer>
      <geo_h>10.0</geo_h>
      <height>578</height>
      <id>2</id>
      <lat_bl>43.5905</lat_bl>
      <lat_br>43.6875</lat_br>
      <lat_c>43.6395</lat_c>
      <lat_tl>43.5914</lat_tl>
      <lat_tr>43.6885</lat_tr>
      <lon_bl>43.4584</lon_bl>
      <lon_br>43.4599</lon_br>
      <lon_c>43.4809</lon_c>
      <lon_tl>43.5018</lon_tl>
      <lon_tr>43.5033</lon_tr>
      <mapId>2</mapId>
      <name>Layer 2</name>
      <points>
        <point>
          <id>CAM:1</id>
          <layerId>2</layerId>
          <mapId>2</mapId>
          <angle>0.0</angle>
          <geo_angle>0.0</geo_angle>
          <latitude>43.47727</latitude>
          <longitude>43.602381</longitude>
          <x>95.0</x>
          <y>329.0</y>
        </point>
      </points>
      <width>800</width>
      <zoomDef>1.0</zoomDef>
      <zoomMax>4.0</zoomMax>
      <zoomMin>0.25</zoomMin>
      <zoomStep>0.25</zoomStep>
    </layer>
  </layers>
  <name>Map 2</name>
</karta>
</kartas>

```

### Response parameters

Parameter	Description
<b>&lt;karta&gt; group parameters</b>	
id	Map ID

Parameter	Description
name	Map name
layers	Layer list
<b>&lt;layer&gt; group parameters</b>	
geo_h	Height mark (see <a href="#">Configuring map binding to coordinate grid</a> )
height	Layer substrate height in pixels
width	Layer substrate width in pixels
id	Layer ID
lat_bl	Latitude: bottom left corner
lat_br	Latitude: bottom right corner
lat_c	Latitude: center
lat_tl	Latitude: top left corner
lat_tr	Latitude: top right corner
lon_bl	Longitude: bottom left corner
lon_br	Longitude: bottom right corner
lon_c	Longitude: center
lon_tl	Longitude: top left corner
lon_tr	Longitude: top right corner
mapId	Map ID
name	Layer name
points	List of points on the layer

Parameter	Description
zoomDef	Default scale
zoomMax	Minimum scale
zoomMin	Maximum scale
zoomStep	Scale
<b>&lt;point&gt; group parameters</b>	
id	Object type and ID in the format TYPE:ID
layerId	Layer ID
mapId	Map ID
angle	Object icon rotation angle
geo_angle	Viewing angle (for camera, see <a href="#">Configuring the camera viewing angle display on the Map</a> )
latitude	Latitude (object coordinate) The parameter has non-zero value if: <ul style="list-style-type: none"> <li>1. An external map is used for the layer background (see <a href="#">Configuring the external Map server</a>), or</li> <li>2. The layer is tied to geo coordinates (see <a href="#">Configuring map binding to coordinate grid</a>)</li> </ul>
longitude	Longitude (object coordinate) The parameter has non-zero value if: <ul style="list-style-type: none"> <li>1. An external map is used for the layer background (see <a href="#">Configuring the external Map server</a>), or</li> <li>2. The layer is tied to geo coordinates (see <a href="#">Configuring map binding to coordinate grid</a>)</li> </ul>
x	The coordinate of the point relative to the substrate along the X axis
y	The coordinate of the point relative to the substrate along the Y axis

### 13.5.2 Information on one map

General request format:

GET http://IP-address:port/web2/secure/kartas/{plan}/

Request parameters:

Parameter	Is required	Description
plan	Yes	Map ID

Request example:

GET http://127.0.0.1:8085/web2/secure/kartas/2

**Response example:**

```
<karta>
  <id>2</id>
  <name>This is plan of a building</name>
</karta>
```

Response parameters:

Parameter	Description
id	Map ID
name	Map name

### 13.5.3 The list of layers for specific map

General request format:

GET http://IP-address:port/web2/secure/kartas/{plan}/layers

Request parameters:

Parameter	Is required	Description
plan	Yes	Map ID

Request example:

GET http://127.0.0.1:8085/web2/secure/kartas/2/layers

**Response example:**

```

<layers>
  <layer>
    <geo_h>10.0</geo_h>
    <height>578</height>
    <id>2</id>
    <lat_bl>43.5905</lat_bl>
    <lat_br>43.6875</lat_br>
    <lat_c>43.6395</lat_c>
    <lat_tl>43.5914</lat_tl>
    <lat_tr>43.6885</lat_tr>
    <lon_bl>43.4584</lon_bl>
    <lon_br>43.4599</lon_br>
    <lon_c>43.4809</lon_c>
    <lon_tl>43.5018</lon_tl>
    <lon_tr>43.5033</lon_tr>
    <mapId>2</mapId>
    <name>Layer 2</name>
    <points>
      <point>
        <id>CAM:1</id>
        <layerId>2</layerId>
        <mapId>2</mapId>
        <angle>0.0</angle>
        <geo_angle>0.0</geo_angle>
        <latitude>43.47727</latitude>
        <longitude>43.602381</longitude>
        <x>95.0</x>
        <y>329.0</y>
      </point>
    </points>
    <width>800</width>
    <zoomDef>1.0</zoomDef>
    <zoomMax>4.0</zoomMax>
    <zoomMin>0.25</zoomMin>
    <zoomStep>0.25</zoomStep>
  </layer>
</layers>

```

**Response parameters**

Parameter	Description
<b>&lt;layer&gt; group parameters</b>	
geo_h	Height mark (see <a href="#">Configuring map binding to coordinate grid</a> )

<b>Parameter</b>	<b>Description</b>
height	Layer substrate height in pixels
width	Layer substrate width in pixels
id	Layer ID
lat_bl	Latitude: bottom left corner
lat_br	Latitude: bottom right corner
lat_c	Latitude: center
lat_tl	Latitude: top left corner
lat_tr	Latitude: top right corner
lon_bl	Longitude: bottom left corner
lon_br	Longitude: bottom right corner
lon_c	Longitude: center
lon_tl	Longitude: top left corner
lon_tr	Longitude: top right corner
mapId	Map ID
name	Layer name
points	List of points on the layer
zoomDef	Default scale
zoomMax	Minimum scale
zoomMin	Maximum scale
zoomStep	Scale

Parameter	Description
<b>&lt;point&gt; group parameters</b>	
id	Object type and ID in the format TYPE:ID
layerId	Layer ID
mapId	Map ID
angle	Object icon rotation angle
geo_angle	Viewing angle (for camera, see <a href="#">Configuring the camera viewing angle display on the Map</a> )
latitude	Latitude (point coordinate) The parameter has non-zero value if: <ol style="list-style-type: none"> <li>1. An external map is used for the layer background (see <a href="#">Configuring the external Map server</a>), or</li> <li>2. The layer is tied to geo coordinates (see <a href="#">Configuring map binding to coordinate grid</a>)</li> </ol>
longitude	Longitude (point coordinate) The parameter has non-zero value if: <ol style="list-style-type: none"> <li>1. An external map is used for the layer background (see <a href="#">Configuring the external Map server</a>), or</li> <li>2. The layer is tied to geo coordinates (see <a href="#">Configuring map binding to coordinate grid</a>)</li> </ol>
x	The coordinate of the point relative to the substrate along the X axis
y	The coordinate of the point relative to the substrate along the Y axis

### 13.5.4 Information on a specific layer

General request format:

GET http://IP-address:port/web2/secure/kartas/{plan}/layers/{base}/

## Request parameters:

Parameter	Is required	Description
plan	Yes	Map ID
base	Yes	Layer ID

## Request example:

GET http://127.0.0.1:8085/web2/secure/kartas/2/layers/2/

## Response example:

```
<layer>
  <height>1000</height>
  <id>2</id>
  <mapId>2</mapId>
  <name>Base layer for plan</name>
  <width>1000</width>
  <zoomDef>1.0</zoomDef>
  <zoomMax>4.0</zoomMax>
  <zoomMin>0.25</zoomMin>
  <zoomStep>0.25</zoomStep>
</layer>
```

## Response parameters:

Parameter	Description
height	Layer substrate height in pixels
width	Layer substrate width in pixels
id	Layer ID
mapId	Map ID
name	Layer name
zoomDef	Default scale
zoomMax	Minimum scale

Parameter	Description
zoomMin	Maximum scale
zoomStep	Scale

### 13.5.5 Layer background

General request format:

GET http://IP-address:port/web2/secure/kartas/{plan}/layers/{base}/image.{ext}

Request parameters:

Parameter	Is required	Description
plan	Yes	Map ID
base	Yes	Layer ID
ext	Yes	File extension. Allowed values: <b>png</b> or <b>jpg</b>

Request example:

GET http://127.0.0.1:8085/web2/secure/kartas/2/layers/3/image.png

Response example:

Image in specified format comes in response.

Errors while request execution:

Error	Description
404	<b>JPEG</b> extension is specified in the request.

### 13.5.6 The list of point on the layer

General request format:

GET http://IP-address:port/web2/secure/kartas/{plan}/layers/{base}/points/

Request parameters:

Parameter	Is required	Description
plan	No	Map ID
base	No	Layer ID

### Request example:

GET <http://127.0.0.1:8085/web2/secure/kartas/2/layers/2/points/>

### Response example:

**Note.**

If the display type of the object on the map is different from **Image**, then an empty response is received. See also [Attaching objects to the layers of interactive map](#).

```
<points>
<point>
<id>CAM:1</id>
<layerId>2</layerId>
<mapId>2</mapId>
<angle>0.0</angle>
<geo_angle>0.0</geo_angle>
<latitude>43.47727</latitude>
<longitude>43.602381</longitude>
<x>95.0</x>
<y>329.0</y>
</point>
</points>
```

Response parameters:

Parameter	Description
id	Object ID in the format "TYPE:ID", for example "CAM:1"
layerId	Layer ID
mapId	Map ID
angle	Object icon rotation angle
geo_angle	Viewing angle (for camera, see <a href="#">Configuring the camera viewing angle display on the Map</a> )

Parameter	Description
latitude	Latitude (point coordinate). The parameter has non-zero value if: <ol style="list-style-type: none"> <li>1. An external map is used for the layer background (see <a href="#">Configuring the external Map server</a>), or</li> <li>2. The layer is tied to geo coordinates (see <a href="#">Configuring map binding to coordinate grid</a>)</li> </ol>
longitude	Longitude (point coordinate). The parameter has non-zero value if: <ol style="list-style-type: none"> <li>1. An external map is used for the layer background (see <a href="#">Configuring the external Map server</a>), or</li> <li>2. The layer is tied to geo coordinates (see <a href="#">Configuring map binding to coordinate grid</a>)</li> </ol>
x	X coordinate of the upper left corner of the object icon
y	Y coordinate of the upper left corner of the object icon

The coordinate plane is attached to the layer as follows:



I.e. x and y cannot be negative, but can be fractional.

### 13.5.7 Information on a specific point on the layer

General request format:

GET http://IP-address:port/web2/secure/kartas/{plan}/layers/{base}/points/{CAM:id}

Request parameters:

Parameter	Is required	Description
plan	No	Map ID

Parameter	Is required	Description
base	No	Layer ID
CAM:id	Yes	Object ID in the format "TYPE:ID", for example "CAM:1"

**Request example:**

GET http://127.0.0.1:8085/web2/secure/kartas/plan/layers/base/points/CAM:2

**Response example:**

```
<point>
  <id>CAM:2</id>
  <layerId>base</layerId>
  <mapId>plan</mapId>
  <x>200.0</x>
  <y>200.0</y>
</point>
```

## Response parameters:

Parameter	Description
id	Object ID in the format "TYPE:ID", for example "CAM:1"
layerId	Layer ID
mapId	Map ID
x	X coordinate of the upper left corner of the object icon
y	Y coordinate of the upper left corner of the object icon

## 13.6 Object classes

### 13.6.1 The list of object classes on the server

## General request format:

GET http://IP-address:port/web2/secure/objectClasses

**Request example:**

GET http://127.0.0.1:8085/web2/secure/objectClasses

**Response example:**

```

<objectClasses>
  <objectClass>
    <id>GRELE</id>
  </objectClass>
  <objectClass>
    <id>USERS</id>
  </objectClass>
  <objectClass>
    <id>CAM</id>
  </objectClass>
  <objectClass>
    <id>RIGHTS</id>
  </objectClass>
  <objectClass>
    <id>GRAY</id>
  </objectClass>
</objectClasses>

```

**Response parameters:**

Parameter	Description
id	Object class ID

### 13.6.2 Specific object class

**General request format:**

GET http://IP-address:port/web2/secure/objectClasses/{objectClass}/

**Request parameters:**

Parameter	Is required	Description
objectClass	Yes	Object class ID

**Request example:**

GET http://127.0.0.1:8085/web2/secure/objectClasses/GRELE/

**Response example:**

```

<objectClass>
  <id>GRELE</id>

```

```
</objectClass>
```

Response parameters:

Parameter	Description
id	Object class ID

### 13.6.3 The list of states for a specific object class

General request format:

GET http://IP-address:port/web2/secure/objectClasses/{objectClass}/states/

Request parameters:

Parameter	Is required	Description
objectClass	Yes	Object class ID

#### Request example:

GET http://127.0.0.1:8085/web2/secure/objectClasses/GRELE/states/

Response **example:**

```
<states>
  <state>
    <id>off</id>
  </state>
  <state>
    <id>on</id>
  </state>
  <state>
    <id>disabled</id>
  </state>
</states>
```

Response parameters:

Parameter	Description
id	The ID of all possible states of the object class

### 13.6.4 Information on a specific state

General request format:

GET http://IP-address:port/web2/secure/objectClasses/{ObjectClass}/states/{State}/

Request parameters:

Parameter	Is required	Description
ObjectClass	Yes	Object class ID
State	Yes	Object class state ID

#### Request example:

GET http://127.0.0.1:8085/web2/secure/objectClasses/GRELE/states/off/

Response **example:**

```
<state>
  <id>off</id>
</state>
```

Response parameters:

Parameter	Description
id	Object class state ID

### 13.6.5 Getting the icon for a specific state

General request format:

GET http://IP-address:port/web2/secure/objectClasses/{ObjectClass}/states/{State}/image.png

Request parameters:

Parameter	Is required	Description
objectClass	Yes	Object class ID
State	Yes	Object class state ID

**Request example:**

GET http://127.0.0.1:8085/web2/secure/objectClasses/GRELE/states/off/image.png

**Response example:**

The answer will be a png image.

### 13.6.6 The list of events for a specific object class

**General request format:**

GET http://IP-address:port/web2/secure/objectClasses/{ObjectClass}/events/

**Request parameters:**

Parameter	Is required	Description
ObjectClass	Yes	Object class ID

**Request example:**

GET http://127.0.0.1:8085/web2/secure/objectClasses/GRELE/events/

**Response example:**

```
<events>
  <event>
    <id>23</id>
    <sid>grele.disable</sid>
    <description>Disable rele</description>
  </event>
  <event>
    <id>24</id>
    <sid>grele.enable</sid>
    <description>Enable rele</description>
  </event>
</events>
```

**Response parameters:**

Parameter	Description
id	Object ID
sid	Event command
description	Event description

## 13.7 Objects

### 13.7.1 Getting list of all server objects

General request format:

GET http://IP-address:port/web2/secure/configuration?pageltems={pageltems}&page={page}

Request parameters:

Parameter	Is required	Description
pageltems	No	Sets the number of objects displayed on the page. The value must be greater than 0, by default page=1000.  The <b>page</b> parameter only applies when the <b>pageltems</b> parameter is specified
page	No	Sets the page number displayed as a result of the request. The value must be greater than 0, by default pageltems=1

**⚠ Attention!**

If there are many objects in the system (>1000) they are to be displayed by pages.

Processing of all objects is performed page by page until an empty array is received.

Request example:

GET http://127.0.0.1:8085/web2/secure/configuration

Response example:

The request returns the list of the following objects with states:

- cameras added to the Web-server with IDs of linked microphones, dynamics, PTZ devices, presets, as well as monitors and displays to which the camera added (see also [Selecting and configuring cameras for the Web-server module](#));
- displays and monitors on which the cameras added to the Web-server are displayed;
- cameras added to maps selected for Web Server 2.0 are returned – see [Selecting maps](#);
- sensors;
- relays;
- macros;
- RTSP servers with ports used, cameras added;
- list of zones and regions.

JSON:

```
[
  {
    "id": "1",
    "name": "Area 1",
    "regions": [
      {
        "id": "1.1",
        "zoneId": "1",
        "name": "Region 1.1",
        "zoneDescription": "Zone description"
      }
    ]
  },
  {
    "type": "DISPLAY",
    "id": "DISPLAY:1",
    "extId": "1",
    "name": "Display 1",
    "displayId": "1",
    "state": {
      "id": "normal",
      "type": "NORMAL",
      "fullState": null
    }
  },
  {
    "type": "MACRO",
    "id": "MACRO:2",
    "extId": "2",
    "name": "Macro 2",
    "state": {
      "id": "normal",
      "type": "NORMAL",
      "fullState": null
    }
  },
  {
    "type": "STREAMING_SERVER",
    "id": "STREAMING_SERVER:1",
    "extId": "1",
    "name": "RTSP Server 1",
    "state": {
      "id": "normal",
      "type": "NORMAL",
      "fullState": null
    },
    "port": "554",
    "cams": "1;;;;;"
  },
  {
    "type": "CAM",
```

```

    "id": "CAM:1",
    "extId": "1",
    "name": "Camera 1",
    "displayId": "1",
    "monitorId": "1",
    "state": {
      "id": "connected_recording",
      "type": "NORMAL",
      "fullState": "DISARMED|RECORDER_ON|RECORDING"
    },
    "presets": []
  },
  {
    "type": "SLAVE",
    "id": "SLAVE:R-GYZYEV",
    "extId": "R-GYZYEV",
    "name": "Computer DESKTOP-JHRURJJ",
    "state": {
      "id": "connected",
      "type": "NORMAL",
      "fullState": null
    }
  },
  {
    "type": "MONITOR",
    "id": "MONITOR:1",
    "extId": "1",
    "name": "Monitor 1",
    "displayId": "1",
    "monitorId": "1",
    "state": {
      "id": "normal",
      "type": "NORMAL",
      "fullState": null
    },
    "camList": [
      "1"
    ]
  }
]

```

XML:

```

<baseObjects>
  <CAM>
    <displayId>1</displayId>
    <extId>9</extId>
    <geo_angle>0.0</geo_angle>
    <id>CAM:9</id>
    <latitude>-98.0533</latitude>
    <longitude>56.4089</longitude>
    <monitorId>1;2</monitorId>

```

```

<name>Camera 9</name>
<regionId />
<state>
  <fullState>DISARMED</fullState>
  <id>connected</id>
  <type>NORMAL</type>
</state>
<type>CAM</type>
<additionalInfo />
<micId />
<presets />
<speakerId />
<telemetryId />
</CAM>
<baseObject>
  <displayId>1</displayId>
  <extId>1</extId>
  <id>DISPLAY:1</id>
  <name>Display 1</name>
  <state>
    <id>normal</id>
    <type>NORMAL</type>
  </state>
  <type>DISPLAY</type>
</baseObject>
<CAM>
  <displayId>1</displayId>
  <extId>5</extId>
  <geo_angle>0.0</geo_angle>
  <id>CAM:5</id>
  <latitude>-97.6674</latitude>
  <longitude>56.3588</longitude>
  <monitorId>1</monitorId>
  <name>pos</name>
  <regionId />
  <state>
    <fullState>DISARMED</fullState>
    <id>connected</id>
    <type>NORMAL</type>
  </state>
  <type>CAM</type>
  <additionalInfo />
  <micId />
  <presets />
  <speakerId />
  <telemetryId />
</CAM>
<STREAMING_SERVER>
  <cams>1;2;3;4;5;6;9;;;;;;;;;;</cams>
  <extId>1</extId>
  <id>STREAMING_SERVER:1</id>
  <name>RTSP Server 1</name>

```

```

<state>
  <id>normal</id>
  <type>NORMAL</type>
</state>
<type>STREAMING_SERVER</type>
<port>5543</port>
</STREAMING_SERVER>
<CAM>
  <displayId>1</displayId>
  <extId>1</extId>
  <geo_angle>0.0</geo_angle>
  <id>CAM:1</id>
  <latitude>-98.3293</latitude>
  <longitude>56.741</longitude>
  <monitorId>1;2</monitorId>
  <name>Camera 1</name>
  <regionDescription />
  <regionId>1.1</regionId>
  <regionName>Region 1.1</regionName>
  <state>
    <fullState>DISARMED</fullState>
    <id>connected</id>
    <type>NORMAL</type>
  </state>
  <type>CAM</type>
  <zoneId>1</zoneId>
  <zoneName>Area 1</zoneName>
  <additionalInfo />
  <micId />
  <presets />
  <speakerId />
  <telemetryId />
</CAM>
<SLAVE>
  <extId>R-GYZYEV</extId>
  <id>SLAVE:R-GYZYEV</id>
  <name>LOCALHOST</name>
  <state>
    <id>connected</id>
    <type>NORMAL</type>
  </state>
  <type>SLAVE</type>
</SLAVE>
<baseObject>
  <displayId>1</displayId>
  <extId>2</extId>
  <id>MONITOR:2</id>
  <monitorId>2</monitorId>
  <name>Monitor 2</name>
  <state>
    <id>normal</id>
    <type>NORMAL</type>

```

```

</state>
<type>MONITOR</type>
</baseObject>
<baseObject>
<displayId>1</displayId>
<extId>1</extId>
<id>MONITOR:1</id>
<monitorId>1</monitorId>
<name>Monitor 1</name>
<state>
<id>normal</id>
<type>NORMAL</type>
</state>
<type>MONITOR</type>
</baseObject>
</baseObjects>

```

Response parameters:

Parameter	Description
<b>General parameters</b>	
extId	Object ID
id	Object type and ID in the format TYPE:ID
name	Object name
state	Object state. The <id>, <type> and <fullState> description see in <a href="#">State of a specific object</a>
type	Object type
<b>Specific parameters</b>	
cams	List of cameras added to the RTSP Server with semicolon as a separator
port	Port used by RTSP Server
regionDescription	Region description
regionId	ID of the region to which the object is added
regionName	Region name

Parameter	Description
zoneId	ID of the zone to which the object is added
zoneName	Zone name
latitude	Latitude (object coordinate). The parameter has non-zero value if: <ul style="list-style-type: none"> <li>1. An external map is used for the layer background (see <a href="#">Configuring the external Map server</a>), or</li> <li>2. The layer is tied to geo coordinates (see <a href="#">Configuring map binding to coordinate grid</a>)</li> </ul>
longitude	Longitude (object coordinate). The parameter has non-zero value if: <ul style="list-style-type: none"> <li>1. An external map is used for the layer background (see <a href="#">Configuring the external Map server</a>), or</li> <li>2. The layer is tied to geo coordinates (see <a href="#">Configuring map binding to coordinate grid</a>)</li> </ul>
monitorId	For camera: ID of the monitor to which the camera is added. If there are several IDs, they are separated by a semicolon ";"
monitorName	For monitor: name of the monitor
geo_angle	For camera: viewing angle (for camera, see <a href="#">Configuring the camera viewing angle display on the Map</a> )
additionalInfo	For camera: the <b>Additional info</b> field value
micId	For camera: the ID of the associated microphone
presets	For camera: preset list
speakerId	For camera: the ID of the associated speaker
telemetryId	For camera: the ID of the PTZ control panel
displayId	For interface objects: display ID. If there are several IDs, they are separated by a semicolon ";"
displayName	For display: display name
camList	For monitor: IDs of cameras added to the monitor separated by semicolon ";"

### 13.7.2 Information on a specific object

General request format:

GET http://IP-address:port/web2/secure/configuration/{objectClass}:{id}/

Request parameters:

Parameter	Is required	Description
ObjectClass	Yes	Object class ID
id	Yes	Object ID

### Request example:

GET http://127.0.0.1:8085/web2/secure/configuration/GRAY:2/

### Response example:

```
<GRAY>
  <id>GRAY:2</id>
  <name>Gray 2</name>
  <state>
    <id>aLarmed</id>
  </state>
</GRAY>
```

Response parameters:

Parameter	Description
id	Object ID in the format "TYPE:ID", for example "CAM:1"
name	Object name in <i>Axxon PSIM</i>
state id	The current state of the object

## 13.7.3 State of a specific object

General request format:

GET http://IP-address:port/web2/secure/configuration/{objectClass}:{id}/state/

Request parameters:

Parameter	Is required	Description
objectClass	Yes	Object class ID
id	Yes	Object ID

**Request example:**

GET http://127.0.0.1:8085/web2/secure/configuration/GRAY:2/state/

**Response example:**

```
<GRAY>
  <id>GRAY:2</id>
  <name>Gray 2</name>
  <state>
    <id>aLarmed</id>
  </state>
</GRAY>
```

**Response parameters:**

Parameter	Description
fullState	Full object state as stored in the database
id	Object state in terms of HTTP API
type	Object state in terms of HTTP API

Possible values of fullState parameter for a sensor are as follows:

Sensor state	fullState in web request	dbo.state
Armed + Closed	ON,ARMED	ON ARMED
Armed + Closed+ Alarm	ON,ALARMED	ON ALARMED
Armed + Closed+ Alarm confirmed	ON,CONFIRMED	ON CONFIRMED
Armed + Closed+ Connection lost	ON,DETACHED_DISARM	ON DETACHED_DISARM
Disarmed + Closed	ON,DISARMED	ON DISARMED
Disarmed + Closed+ Alarm	ON,ALARMED	ON ALARMED
Disarmed + Closed+ Alarm confirmed	ON,CONFIRMED	ON CONFIRMED
Disarmed + Closed+ Connection lost	ON,DETACHED_DISARM	ON DETACHED_DISARM
Armed + Opened	ARMED,OFF	ARMED OFF
Armed + Opened+ Alarm	OFF,ALARMED	OFF ALARMED
Armed + Opened+ Alarm confirmed	OFF,CONFIRMED	OFF CONFIRMED

Sensor state	fullState in web request	dbo.state
Armed + Opened+ Connection lost	DETACHED_DISARM,OFF	DETACHED_DISARM OFF
Disarmed + Opened	DISARMED,OFF	DISARMED OFF
Disarmed + Opened+ Alarm	OFF,ALARMED	OFF ALARMED
Disarmed + Opened+ Alarm confirmed	OFF,CONFIRMED	OFF CONFIRMED
Disarmed + Opened+ Connection lost	DETACHED_DISARM,OFF	DETACHED_DISARM OFF

### 13.7.4 The list of available actions with the object in a specific state

The list of actions is requested not by the object class, but is taken in the context of a specific object as various user rights are possible for the objects of the same class. Information on how to use this list is given in [Sending commands to server](#) section.

General request format:

GET http://IP-address:port/web2/secure/configuration/{objectClass}:{id}/state/actions/

Request parameters:

Parameter	Is required	Description
ObjectClass	Yes	Object class ID
id	Yes	Object ID

#### Request example:

GET http://127.0.0.1:8085/web2/secure/configuration/GRAY:2/state/actions/

#### Response example:

##### XML

```
<actions>
  <action>
    <description>Disarm</description>
    <hidden>>false</hidden>
    <id>DISARM</id>
  </action>
  <action>
    <description>Arm</description>
    <hidden>>false</hidden>
    <id>ARM</id>
  </action>
</actions>
```

```

</action>
<action>
  <description>Classify alarm</description>
  <hidden>>false</hidden>
  <id>CONFIRM</id>
</action>
</actions>

```

If the object state considers no actions, then xml is:

```
<actions/>
```

## JSON

```

[
  {
    "id": "DISARM",
    "description": "Disarm",
    "hidden": false,
    "react": {
      "sourceType": "MACRO",
      "sourceId": "DISARM",
      "action": "RUN",
      "params": {},
      "name": "React",
      "version": 1
    }
  },
  {
    "id": "ARM",
    "description": "Arm",
    "hidden": false,
    "react": {
      "sourceType": "MACRO",
      "sourceId": "ARM",
      "action": "RUN",
      "params": {},
      "name": "React",
      "version": 1
    }
  },
  {
    "id": "CONFIRM",
    "description": "Classify alarm",
    "hidden": false,
    "react": {
      "sourceType": "MACRO",
      "sourceId": "CONFIRM",
      "action": "RUN",

```

```

    "params": {},
    "name": "React",
    "version": 1
  }
}
]
```

Response parameters:

Parameter	Description
description	User-friendly name of the reaction
hidden	true – the reaction is not displayed in the interface (on the map, in macros, etc.) false – the reaction is displayed in the interface
id	System name of the reaction
"react" block in the JSON response	
sourceType	Type of object that can run action
sourceId	System name of the reaction
action	Reaction of the sourceType
params	Available parameters of the reaction
name	Action type: Event or React
version	Version

### 13.7.5 Getting list of all zones and regions

General request format:

GET http://IP-address:port/web2/secure/configuration/zones

**Request example:**

GET http://127.0.0.1:8085/web2/secure/configuration/zones

**Response example:**

JSON:

```
[
```

```

{
  "id": "1",
  "name": "Zone 1",
  "regions": [
    {
      "id": "1.1",
      "zoneId": "1",
      "name": "Region 1.1",
      "zoneDescription": "Zone description"
    }
  ]
},
{
  "id": "2",
  "name": "Zone 2",
  "regions": [
    {
      "id": "2.1",
      "zoneId": "2",
      "name": "Region 2.1",
      "zoneDescription": "Zone description"
    }
  ]
}
]

```

XML:

```

<?xml version="1.0" encoding="UTF-8" standalone="yes"?>
<zones>
  <zone>
    <id>1</id>
    <name>Zone 1</name>
    <regions>
      <id>1.1</id>
      <name>Region 1.1</name>
      <zoneDescription>Zone description</zoneDescription>
      <zoneId>1</zoneId>
    </regions>
  </zone>
  <zone>
    <id>2</id>
    <name>Zone 2</name>
    <regions>
      <id>2.1</id>
      <name>Region 2.1</name>
      <zoneDescription>Zone description</zoneDescription>
      <zoneId>2</zoneId>
    </regions>
  </zone>
</zones>

```

Response parameters:

Parameter	Description
id	ID of the zone/region
name	Name of the zone/region in <i>Axxon PSIM</i>
zoneDescription	Zone description

## 13.8 Getting events

Getting events from the cameras that changed their state during the request execution (~30-60 seconds).

### 13.8.1 General request format:

http://IP-address:port/web2/secure/feed/

### 13.8.2 Request example:

http://127.0.0.1:8085/web2/secure/feed/

### 13.8.3 Response example:

```

<message>
  <action>update</action>
  <objectId>CAM:1</objectId>
  <state>disconnected</state>
</message>

<message>
  <action>state</action>
  <objectId>CAM:1</objectId>
  <x>10.0</x>
  <y>123.9</y>
</message>

<message>
  <action>state</action>
  <objectId>CAM:1</objectId>
  <state>connected</state>
  <x>300.8</x>
  <y>670</y>
</message>

<message>
  <action>state</action>
  <objectId>CAM:1</objectId>
  <x>100</x>

```

```

    <y>100</y>
</message>

<message>
  <action>ping</action>
</message>

```

#### 13.8.4 Response parameters:

Parameter	Description
action	Type of event. Possible values: create, delete, update
objectId	id of the object that is the source of event (always with update, delete, create)
state	id of a new object state (always with create. If the state has not changed, then there is no update state)
x, y	New coordinates, if changed
ts	The time and date of the object state change

#### 13.8.5 Getting events of video subsystem in blocks

General request format:

GET http://IP-address:port/web2/secure/events/

Request parameters:

Parameter	Description
<b>from</b>	The oldest date of message search period. Example: 2012-12-27T15%3A19%3A16.000%2B03%3A00
<b>to</b>	The latest date of message search period. Example: 2012-12-27T15%3A19%3A16.000%2B03%3A00
<b>count</b>	Maximum number of messages in reply in the range [1, 200]. Default is 20. Server can return more messages if there are few messages in the database

Parameter	Description
<b>objectId</b>	<p>Object class and object ID, which are separated by a colon. Examples: CAM:1, GRAY:5, PEOPLE_COUNTER:1 etc. Events can be received from several objects separated by commas. Example: objectId=CAM:1,PEOPLE_COUNTER:1 – the response will contain events for camera 1 and counter 1.</p> <p>If the object ID is not specified in the parameter, then the events by all objects of the specified class will be returned. Example: objectId=CAM – the response will contain events by all cameras</p>
<b>action</b>	<p>Event type. If the parameter is specified, then the response will contain only events of the specified type.</p> <p>Examples:</p> <ul style="list-style-type: none"> <li>• REC – start recording</li> <li>• REC_STOP – stop recording</li> <li>• ARM – arming the camera</li> <li>• DISARM – disarming the camera</li> <li>• disconnected – loss of connection with the camera</li> </ul>

#### Request example:

```
GET http://127.0.0.1:8085/web2/secure/events?
from=2021-05-26T14%3A30%3A30.000%2B03%3A00&to=2021-05-26T15%3A40%3A30.000%2B03%3A00&count=5&
objectId=MACRO:7
```

#### Response example:

XML:

```
<events>
  <event>
    <description>Action executed</description>
    <id>{3AED63A0-19BE-EB11-9020-B42E99FDB342}</id>
    <objectId>MACRO:7</objectId>
    <addInfo>event1</addInfo>
    <params0>User 1</params0>
    <params1>1</params1>
    <params2/>
    <params3/>
    <ts>2021-05-26T14:58:05+03:00</ts>
    <type>Empty</type>
  </event>
  <event>
    <description>Action executed</description>
    <id>{26840B9A-19BE-EB11-9020-B42E99FDB342}</id>
    <objectId>MACRO:7</objectId>
    <addInfo>event2</addInfo>
    <params0>User 1</params0>
    <params1>1</params1>
```

```

    <params2/>
    <params3/>
    <ts>2021-05-26T14:58:04+03:00</ts>
    <type>Empty</type>
  </event>
</events>

```

JSON:

```

[
  {
    "id": "{3AED63A0-19BE-EB11-9020-B42E99FDB342}",
    "objectId": "MACRO:7",
    "ts": "2021-05-26T14:58:05.000+03:00",
    "description": "Action executed",
    "addInfo": "event1",
    "type": "Empty",
    "params2": "",
    "params3": "",
    "params1": "1",
    "params0": "User 1"
  },
  {
    "id": "{26840B9A-19BE-EB11-9020-B42E99FDB342}",
    "objectId": "MACRO:7",
    "ts": "2021-05-26T14:58:04.000+03:00",
    "description": "Action executed",
    "addInfo": "event2",
    "type": "Empty",
    "params2": "",
    "params3": "",
    "params1": "1",
    "params0": "User 1"
  }
]

```

Return codes:

- 200 – OK
- 400 – invalid parameter (e.g. date format)
- 500 – error
- 503 – error of core connection
- 504 – time-out (core failed to return data within 2000 milliseconds)

## 13.9 Sending commands to server

### 13.9.1 General request format:

PUT <http://IP-address:port/web2/secure/configuration/{objectClass}:{id}/state/actions/{CMD}/execute>

### 13.9.2 Request example:

Parameter	Is required	Description
objectClass	Yes	Object class ID
id	Yes	Object ID
CMD	Yes	Command <i>Attention! The command name must be in uppercase.</i>

### 13.9.3 Response example:

PUT http://127.0.0.1:8085/web2/secure/configuration/GRAY:2/state/actions/DISARM/execute

## 13.10 Macros

Macros – predefined sequence of responses to certain events. Macros are created on the server and have IDs and names. They are similar to actions with objects, but are not attached to the object.

### 13.10.1 Getting parameters of macros

General request format:

GET http://IP-address:port/web2/secure/actions/

#### Request parameters:

Parameter	Required	Description
id	Yes	Macro ID

#### Request example:

GET http://127.0.0.1:8085/web2/secure/actions/

**Response example:**

```
<action>
  <description>Start recording for all cameras</description>
  <id>2</id>
</action>
```

**Response parameters:**

Parameter	Description
description	Macro name
id	Macro ID

### 13.10.2 Getting the list of macros

**General request format:**

GET http://IP-address:port/web2/secure/actions/{id}/

**Request parameters:**

Parameter	Is required	Description
id	Yes	Macro ID

**Request example:**

GET http://127.0.0.1:8085/web2/secure/actions/2/

**Response example:**

```
<action>
  <description>Start recording by all cameras</description>
  <id>2</id>
</action>
```

**Response parameters:**

Parameter	Description
description	Macro name

Parameter	Description
id	Macro ID

### 13.10.3 Macros execution on server request

General request format:

PUT `http://IP-address:port/web2/secure/configuration/{id}/state/actions/RUN/execute`

**Request parameters:**

Parameter	Is required	Description
id	Yes	Macro type and ID in the format TYPE:ID (for example MACRO:1)

**Request example:**

PUT `http://127.0.0.1:8085/web2/secure/configuration/MACRO:1/state/actions/RUN/execute`

## 13.11 Video

### 13.11.1 Thumbnails request

General request format:

First way

GET `http://IP-address:port/web2/secure/video/image.jpg?cam.id={cam.id}&width={width}&height={height}&version={version}&login={login}&password={password}`

Request parameters:

Parameter	Is required	Description
cam.id	Yes	Camera ID
width	No	Value can be in [64, 1600] range. Server automatically rounds width to larger value divisible by 4 Size of returned image is taken from video stream if width parameter are not set.

Parameter	Is required	Description
height	No	Value can be in [30, 1200] range. Size of returned image is taken from video stream if height parameter are not set.
version	No	See <a href="#">Product version</a>
login	No	<i>Axxon PSIM</i> username, if set
password	No	<i>Axxon PSIM</i> user password, if set

#### Second way

```
GET http://IP-address:port/web2/secure/video/action.do?version={version}
&command=frame.video&video_in={video_in}&imageWidth={imageWidth}&imageHeight={imageHeight}
&login={login}&password={password}
```

#### Request parameters:

Parameter	Is required	Description
version	No	See <a href="#">Product version</a>
video_in	Yes	Camera ID in the format "TYPE:ID", for example "CAM:1"
imageWidth	No	Value can be in [64, 1600] range. Server automatically rounds width to larger value divisible by 4 Size of returned image is taken from video stream if width parameter are not set.
imageHeight	No	Value can be in [30, 1200] range. Size of returned image is taken from video stream if height parameter are not set.
login	No	<i>Axxon PSIM</i> username, if set
password	No	<i>Axxon PSIM</i> user password, if set

#### Request example:

##### First way

```
GET http://127.0.0.1:8085/web2/secure/video/image.jpg?
cam.id=5&width=85&version=4.7.8.0&login=USER&password=PASS
```

Second way

```
GET http://127.0.0.1:8085/web2/secure/video/action.do?
version=4.9.0.0&command=frame.video&video_in=CAM:1&imageWidth=400
```

### Response **example:**

Jpg image of approximately requested size or error code and zero length body (i.e. only headings) will be received in reply.

In case of error the http error code is returned:

404 – camera disabled or not in use (disabled);

403 – invalid password;

426 – old client version;

429 – too many requests;

444 – camera signal is lost or camera disabled (coaxial conductor disconnected from card);

503 – archive error.

## 13.11.2 Configuration request

General request format:

```
GET http://IP-address:port/web2/secure/video/config.properties?version={version}&login={login}
&password={password}
```

Request parameters:

Parameter	Is required	Description
version	Yes	See <a href="#">Product version</a>
login	No	<i>Axxon PSIM</i> username, if set
password	No	<i>Axxon PSIM</i> user password, if set

### Request **example:**

```
GET http://127.0.0.1:8085/web2/secure/video/config.properties?version=4.7.8.0&login=USER&password=PASS
```

### Response **example:**

Config.properties text file.

If a password is set but not specified in the request:

```
password.enabled=true
login.enabled=true
password.invalid=true#
```

If the password is correct or access is allowed without the password, then the server sends the following configuration:

```
password.enabled=true
login.enabled=true
password.invalid=false
cam.0.id=2
cam.0.name=Face
cam.0.rights=11
cam.1.id=3
cam.1.name=Camera 3
cam.1.rights=11
cam.2.id=5
cam.2.name=Camera 5
cam.2.rights=11
cam.2.telemetry_id=1.1
cam.count=3#
```

**Response parameters:**

Parameter	Description
password.enabled	false – no password required true – password required
login.enabled	false – no login required true – login required
password.invalid	false – specified password is correct true – specified password is not correct
cam.count	Total count of cameras in the configuration (id starts at 0)
cam.N.id	Camera ID
cam.N.name	Camera name
cam.N.rights	<p>Rights (they are checked on the server; available on the client in order not to show the user odd options). The parameter is represented by flags. If the flag is set, then the interface element is to be shown; if not – hidden.</p> <pre>static final int RIGHT_VIEW = 0x1; // live video is available (always 1) static final int RIGHT_CONTROL = 0x2; // control (telemetry, arming and disarming) static final int RIGHT_CONFIG = 0x4; // reserved static final int RIGHT_HISTORY = 0x8; // access to archive</pre>

Parameter	Description
cam.N.telemetry_id	Telemetry ID (there can be no value if there is no telemetry – then hide telemetry control elements)

### 13.11.3 Video query

General request format:

GET http://IP-address:port/web2/secure/video/action.do?version={version}&sessionid={sessionid}&video\_in={video\_in}&normalize={normalize}&imageWidth={imageWidth}&imageHeight={imageHeight}&fps={fps}&login={login}&password={password}

Request parameters:

Parameter	Is required	Description
version	Yes	See <a href="#">Product version</a> <i>Note. Not more than 6 video streams can be received simultaneously</i>
video_in	Yes	Camera ID in the format "TYPE:ID", for example "CAM:1"
sessionid	No	Session ID
imageWidth	No	Frame width. Value can be in [64, 1600] range. Server automatically rounds width to larger value divisible by 4
imageHeight	No	Frame height. Value can be in [30, 1200] range. If not, then the size of the returned image is taken from the video stream
normalize	No	true – stretches the image if the frame comes in incorrect proportions
fps	No	Video frame rate
login	No	<i>Axxon PSIM</i> username, if set
password	No	<i>Axxon PSIM</i> user password, if set

**Request example:**

```
GET http://127.0.0.1:8085/web2/secure/video/action.do?
version=4.10.0.0&sessionId=1234567890&video_in=CAM:1&imageWidth=200&fps=1&login=USER&password=PASS
```

**Response example:**

```
<html>
  <head/>
  <body>
    
  </body>
</html>
```

**13.11.4 Curl video request. Main stream format****General request format:**

```
curl -v "http://IP-address:port/web2/secure/video/action.do?fps={fps}&imageHeight={imageHeight}&login={login}
&normalize={normalize}&password={password}&sessionId={sessionId}&version={version}&video_in={video_in}" --
output ~/output file}.bin
```

**Request parameters:**

Parameter	Is required	Description
version	Yes	See <a href="#">Product version</a> <i>Note. Not more than 6 video streams can be received simultaneously</i>
video_in	Yes	Camera ID in the format "TYPE:ID", for example "CAM:1"
sessionId	No	Session ID
imageWidth	No	Frame width. Value can be in [64, 1600] range. Server automatically rounds width to larger value divisible by 4. If not, then the size of the returned image is taken from the video stream
imageHeight	No	Frame height. Value can be in [30, 1200] range. If not, then the size of the returned image is taken from the video stream
normalize	No	true – stretches the image if the frame comes in incorrect proportions

Parameter	Is required	Description
fps	No	Video frame rate
login	No	<i>Axxon PSIM</i> username, if set
password	No	<i>Axxon PSIM</i> user password, if set
output file name	Yes	The name of the file to which the requested video will be output

**Request example:**

```
curl -v "http://127.0.0.1:8085/web2/secure/video/action.do?
fps=1&imageHeight=360&login=1&normalize=true&password=1&sessionId=A4D98DDE-A535-49E4-9FB5-
FAD441CBBA43&version=4.10.0.0&video_in=CAM:1" --output ~/output.bin
```

**Response example:**

```
% Total % Received % Xferd Average Speed Time Time Time Current
      Dload Upload Total Spent Left Speed
 0  0  0  0  0  0  0  --:--:-- --:--:-- --:--:-- 0* Connected to 172.19.2.6
(172.19.2.6) port 8085 (#0)
* Server auth using Basic with user '1'
> GET /web2/secure/video/action.do?
fps=1&imageHeight=360&login=1&normalize=true&password=1&sessionId=A4D98DDE-
A535-49E4-9FB5-FAD441CBBA43&version=4.10.0.0&video_in=CAM:1 HTTP/1.1
> Host: 172.19.2.6:8085
> Authorization: Basic MTox
> User-Agent: curl/7.74.0
> Accept: */*
>
* Mark bundle as not supporting multiuse
< HTTP/1.1 200 OK
< Set-Cookie: JSESSIONID=ae532304-e6dc-4a19-8c4f-1e10656140f2; Path=/web2; HttpOnly
< Set-Cookie: rememberMe=deleteMe; Path=/web2; Max-Age=0; Expires=Sun, 24-Jan-2021
08:09:52 GMT
< Server: AxxonSoft-Axxon PSIM-Webserver/4.11.2.3000
< Date: Mon, 25 Jan 2021 08:09:52 GMT
< Cache-Control: no-store, no-cache, must-revalidate, max-age=0
< Connection: close
< Content-Type: multipart/x-mixed-replace;boundary=videoframe
< Pragma: no-cache
< X-CameraID: 1
< X-SessionID: A4D98DDE-A535-49E4-9FB5-FAD441CBBA43
< Closing connection 0
```

```
<
{ [32768 bytes data]
```

**Response parameters:**

The Content-Type header contains the following parameters:

Parameter	Description
multipart/x-mixed-replace	Indicates that each subsequent piece of content should replace the previous one
boundary	Indicates a text separator between pieces of content

**Response example:**

The output file will contain the following parameters for each piece of requested content:

```
--videoframe
Content-Type: image/jpeg
Content-Length: 93081
X-Width: 480
X-Height: 360
X-Timestamp: 0.000
X-Time: 2021-01-25T10:06:42.816+03:00
```

**Response parameters:**

Parameter	Description
Content-Type	Type of content
Content-Length	Piece of content size
X-Width	Image width
X-Height	Image height
X-Time	Absolute frame time
X-Timestamp	Relative frame time in seconds (relative to the beginning of the stream)

**Response example:**

If the stream ends due to the server failure, a final packet may be received:

```

--videoframe
Content-Type: image/jpeg
Content-Length: 106
<video_in>
  <sessionid>A4D98DDE-A535-49E4-9FB5-FAD441CBBA43</sessionid>
  <video_in>CAM:1</video_in>
  <newstate>closed</newstate>
  <errcode>103</errcode>
</video_in>
    
```

**Response parameters:**

Parameter	Description
sessionid	session id (same as at start)
video_in	Camera ID in the "TYPE:ID" format, for example, "CAM:1"
errcode	Error code: <ul style="list-style-type: none"> <li>• 100 – no error.</li> <li>• 101 – too many connected users.</li> <li>• 102 – incorrect password (theoretically, the password can be changed at any time of work).</li> <li>• 103 – video not available.</li> <li>• 104 – old version of the client. Update the version.</li> </ul>

**13.11.5 Format of main stream**

**Example request:**

```

HTTP/1.0 200 OK
Connection: close
Server: AxxonSoft-PSIM-Webserver/4.9.0.0
Cache-Control: no-store,no-cache,must-revalidate,max-age=0
Pragma: no-cache
Date: Mon, 13 Jan 2013 10:44:27 GMT
Content-Type: multipart/mixed;boundary=videoframe

--videoframe
Content-Type: text/xml
Content-Length: 138
    
```

```

<video_in>
  <sessionid>FC126734</sessionid>
  <video_in>CAM:5</video_in>
  <newstate>started</newstate>
  <errcode>100</errcode>
</video_in>
--videoframe
Content-Type: image/jpeg
Content-Length: 23978
X-Width: 320
X-Height: 240
X-Time: 2013-03-15T10:51:44.314+04:00
X-Timestamp: 0.000

  <jpeg image>
--videoframe
Content-Type: image/jpeg
Content-Length: 23651
X-Width: 320
X-Height: 240
X-Time: 2013-03-15T10:51:44.314+04:00
X-Timestamp: 0.152

  <jpeg image>
    
```

**Response parameters:**

Parameter	Description
X-Width	Image width
X-Height	Image height
X-Time	Absolute time of frame forming
X-Timestamp	Relative frame time in seconds (relatively stream head)

**Example response:**

In case of stream end due to the fault of server, the end packet can be received:

```

--videoframe
Content-Type: text/xml
Content-Length: 106
<video_in>
  <sessionid>FC126734</sessionid>
    
```

```

<video_in>CAM:5</video_in>
<newstate>closed</newstate>
<errcode>103</errcode>
</video_in>

```

**Response** parameters:

Parameter	Description
sessionid	Session ID (the same as at start)
video_in	Camera ID
errcode	Error code: <ul style="list-style-type: none"> <li>• 100 – error absence.</li> <li>• 101 – too many connected users.</li> <li>• 102 – invalid password (theoretically, it's possible to change password at any moment).</li> <li>• 103 – unavailable video.</li> <li>• 104 – old client version. Update version.</li> </ul>

## 13.11.6 Camera managing

## General request format:

GET http://IP-address:port/web2/secure/video/action.do?version={version}&sessionid={sessionid}&cam.id={cam.id}&target=CAM&targetid={targetid}&command={command}&login={login}&password={password}

## Request parameters:

Parameter	Is required	Description
version	Yes	See <a href="#">Product version</a>
cam.id	Yes	Camera ID
sessionid	No	Session ID
target	Yes	CAM—"Camera" object class ID
targetid	Yes	Matches cam.id

Parameter	Is required	Description
command	Yes	Camera control commands: <ul style="list-style-type: none"> <li>• Start recording: REC</li> <li>• Stop recording: REC_STOP</li> <li>• Arming: ARM</li> <li>• Disarming: DISARM</li> </ul>
manual<number>	Yes	Manual recording mode. The parameter is automatically generated for Start recording and Stop recording commands.  <number> can be 0 (manual recording mode disabled) or 1 (manual recording mode enabled)
login	No	Axxon PSIM username, if set
password	No	Axxon PSIM user password, if set

### Request example:

```
GET http://127.0.0.1:8085/web2/secure/video/action.do?
version=4.10.0.0&sessionId=29101F1&cam.id=1&target=CAM&targetid=1&command=REC&parameters=manual<1>
```

```
GET http://127.0.0.1:8085/web2/secure/video/action.do?
version=4.10.0.0
&sessionId=29101F1&cam.id=1&target=CAM&targetid=1&command=REC_STOP&parameters=manual<1>
```

```
GET http://127.0.0.1:8085/web2/secure/video/action.do?
version=4.10.0.0&sessionId=29101F1&cam.id=1&target=CAM&targetid=1&command=ARM
```

```
GET http://127.0.0.1:8085/web2/secure/video/action.do?
version=4.10.0.0&sessionId=29101F1&cam.id=1&target=CAM&targetid=1&command=DISARM
```

 PTZ control

### 13.11.7 Authorization by token

To receive a pre-authorized link to the camera (to receive both live or archived video), you must:

- Execute a request to get a token;
- Execute a request for the received token.

General request format to get a token:

```
GET http://IP-address:port/web2/secure/video/action.do?version={version}&sessionId={sessionId}
&video_in={video_in}&enable_token_auth={enable_token_auth}&valid_token_hours={valid_token_hours}
&login={login}&password={password}
```

Request parameters:

Parameter	Is required	Description
version	Yes	See <a href="#">Product version</a>
video_in	Yes	Camera ID in the format "TYPE:ID", for example "CAM:1"
sessionid	No	Session ID
targetid	Yes	Matches cam.id
login	No	<i>Axxon PSIM</i> username, if set
password	No	<i>Axxon PSIM</i> user password, if set
enable_token_auth	Yes	Enable authorization by token = <b>1</b> .
valid_token_hours	No	Signature validation time (in hours). The maximum value is a week. The default value is 12 hours.

### Request example:

```
GET http://127.0.0.1:8085/web2/secure/video/action.do?
version=4.10.0.0&sessionid=FC126734&video_in=CAM:1&enable_token_auth=1&valid_token_hours=1&login=USER&password=PASS
```

### Response example:

```
{
  "path" : "action.do?hmac=GAqUa429sjY2E9jCTpuYeaMqReW3Y7HI"
}
```

Response parameters:

Parameter	Description
hmac	Token

General request format for the received token via **Web server 2.0**:

```
GET http://IP-address:port/web2/secure/video/action.do?hmac={hmac}
```

Request parameters:

Parameter	Is required	Description
hmac	Yes	Earlier received token

### Request example:

GET http://127.0.0.1:8085/web2/secure/video/action.do?hmac=GAqUa429sjY2E9jCTpuYeaMqReW3Y7HI

General request format for the received token via **Web-server 1**:

 **Note**

This request method is deprecated. It is recommended to make a request via the **Web server 2.0** module.

GET http://IP-address:{port}/action.do?hmac={hmac}

Request parameters:

Parameter	Is required	Description
port	Yes	Port number specified for HTTP Server connection on the <b>Web server</b> object settings panel (see <a href="#">Setting the parameters of connecting Clients to the Web-server</a> )
hmac	Yes	Earlier received token

### Request example:

GET http://127.0.0.1:80/action.do?hmac=GAqUa429sjY2E9jCTpuYeaMqReW3Y7HI

## 13.12 PTZ control

### 13.12.1 General request format:

GET http://{login}:{password}@IP-address:[port]/web2/secure/video/action.do?version={version}&sessionid={session\_id}&cam.id={cam\_id}&target=PTZ&targetid={PTZ\_device\_id}&command={command}&login={login}&password={password}&speed={speed}&preset={preset}

 **Important!**

Login and password must be specified twice in the request: before the IP address and in parameters. In both cases, this is the same login and password of the *Axxon PSIM* user.

### 13.12.2 Request parameters:

Parameter	Is required	Description
version	Yes	See <a href="#">Product version</a>
session_id	Yes	Session ID
cam_id	Yes	Camera ID
PTZ_device_id	Yes	ID of the PTZ control panel related to the camera (can be obtained in configuration request – see <a href="#">Getting list of all server objects</a> )
command	Yes	The command to be executed. It can take one of the following values: <ul style="list-style-type: none"> <li>• RIGHT – pan right</li> <li>• UP – tilt up</li> <li>• LEFT – pan left</li> <li>• DOWN – tilt down</li> <li>• ZOOM_IN – zoom in</li> <li>• ZOOM_OUT – zoom out</li> <li>• GO_PRESET – go to the specified preset</li> <li>• POINTMOVE – zooming of selected point on the image (x,y)</li> <li>• AREAZOOM – zooming of selected area on the image (x,y,w,h)</li> </ul>
login	Yes	<i>Axxon PSIM</i> username, if set
password	Yes	<i>Axxon PSIM</i> user password, if set
speed	Yes	Command-processing speed (from 0 to 10). It is recommended to use low values due to delays while controlling by network

Parameter	Is required	Description
preset	No	<p>Number of preset. Required parameter only for the command=GO_PRESET. Otherwise its value is ignored.</p> <p><b>x</b> – x coordinate relatively the image size. It takes values from 0.0 to 1.0. Required parameter only for the command=POINTMOVE or command=AREAZOOM. Otherwise its value is ignored.</p> <p><b>y</b> – y coordinate relatively the image size. It takes values from 0.0 to 1.0. Required parameter only for the command=POINTMOVE or command=AREAZOOM. Otherwise its value is ignored.</p> <p><b>w</b> – width of zooming area relatively the image size. It takes values from 0.0 to 1.0. Required parameter only for the command=AREAZOOM. Otherwise its value is ignored.</p> <p><b>h</b> – height of zooming area relatively the image size. It takes values from 0.0 to 1.0. Required parameter only for the command=AREAZOOM. Otherwise its value is ignored.</p>

### 13.12.3 Request example:

GET <http://user:pass@127.0.0.1:8085/web2/secure/video/action.do?version=4.10.0.0&cam.id=5cam.id=1&target=PTZ&targetid=1.1&command=RIGHT&login=user&password=pass&speed=2>

Camera managing

## 13.13 Using the archive

Video archive stream is sent on the same format as live video.

### 13.13.1 Getting list of records (1st way)

General request format:

GET [http://IP-address:port/web2/secure/video/action.do?version={version}&sessionid={sessionid}&video\\_in={video\\_in}&command=arc.intervals&time\\_from={time\\_from}&time\\_to={time\\_to}&max\\_count={max\\_count}&split\\_threshold={split\\_threshold}&login={login}&password={password}](http://IP-address:port/web2/secure/video/action.do?version={version}&sessionid={sessionid}&video_in={video_in}&command=arc.intervals&time_from={time_from}&time_to={time_to}&max_count={max_count}&split_threshold={split_threshold}&login={login}&password={password})

Request parameters:

Parameter	Is required	Description
version	Yes	See <a href="#">Product version</a>

Parameter	Is required	Description
sessionid	No	Session ID
video_in	Yes	Camera ID in the format "TYPE:ID", for example "CAM:1"
command	Yes	Command to receive list of records: arc.intervals
time_from	Yes	Start of interested time range
time_to	No	End of interested time range
max_count	No	Maximal number of records in reply
split_threshold	No	Time for combining several intervals (in seconds). Intervals, distance between which will be less than specified value, will be combined in one
login	No	Axxon PSIM username, if set
password	No	Axxon PSIM user password, if set
format	No	Sets the response format (see <a href="#">General information on HTTP API</a> )

### Request example:

```
GET http://127.0.0.1:8085/web2/secure/video/action.do?
version=4.9.0.0&sessionid=29101F1&video_in=CAM:5&command=arc.intervals&time_from=2013-03-20T00:00:00.00
0+04:00&time_to=2013-03-22T23:59:59.999+04:00&max_count=100&split_threshold=10399&login=USER&password
=PASS
```

### Response example:

XML:

```
<?xml version="1.0" encoding="UTF-8"?>
<records count="1" complete="YES" sort="INCREASE">
  <record>
    <from>2011-09-01T00:00:00-05:00</from>
    <to>2011-09-01T00:00:35-05:00</to>
  </record>
  <record>
    <from>2011-09-01T00:00:35-05:00</from>
    <to>2011-09-01T00:01:10-05:00</to>
  </record>
</records>
```

JSON:

```
{ 'count' : 1,
```

```

'complete' : 'YES',
'sort' : 'INCREASE',
'cam' : '1',
'records' : [ {
  'from' : '2019-01-22T12:41:10.144+03:00',
  'to' : '2019-01-23T08:28:47.346+03:00'
}]
}

```

### 13.13.2 Getting list of records (2nd way)

General request format:

GET http://IP-address:port/web2/secure/archive/{CAM:id}/{DATE}/?[splitThreshold={splitThreshold}]&[days={days}]

Request parameters:

Parameter	Is required	Description
CAM:id	Yes	Camera ID in the format "TYPE:ID", for example "CAM:1"
DATE	Yes	Date of the start of receiving the archive. All time is interpreted as local time for server.
splitThreshold	Yes	If difference between end of previous record and start of next record less than specified value (in milliseconds), than records will be combined in one. Specify splitThreshold=0. [default: 50] not to combine records.
days	Yes	Number of days from the current, for which archive is required. [default: 1]

#### Request example:

GET http://127.0.0.1:8085/web2/secure/archive/CAM:2/2011-12-30/?[splitThreshold=50]&[days=1]

GET http://127.0.0.1:8085/web2/secure/archive/CAM:1/2013-10-18/?splitThreshold=2000 – Get records for 18 October 2013 and combine all records, interval between which less than 2000 milliseconds.

GET http://127.0.0.1:8085/web2/secure/archive/CAM:1/2013-10-18/?days=10 – Get records for 10 days from 18 October 2013.

#### Response example:

XML:

```

<?xml version="1.0" encoding="UTF-16"?>
<days>
  <day>
    <id>2013-11-10T00:00:00-02:00</id>
    <records>

```

```

        <from>2013-11-10T18:44:01.579-02:00</from>
        <to>2013-11-10T18:44:09.717-02:00</to>
    </records>
</day>
<day>
    <id>2013-11-18T00:00:00-02:00</id>
    <records>
        <from>2013-11-18T18:38:30.252-02:00</from>
        <to>2013-11-18T18:38:56.942-02:00</to>
    </records>
    <records>
        <from>2013-11-18T18:39:08.321-02:00</from>
        <to>2013-11-18T18:39:10.080-02:00</to>
    </records>
</day>
</days>

```

JSON:

```

[ {
  "id" : "2013-11-10T00:00:00.000-02:00",
  "records" : [ {
    "from" : "2013-11-10T18:44:01.579-02:00",
    "to" : "2013-11-10T18:44:09.717-02:00"
  } ]
}, {
  "id" : "2013-11-18T00:00:00.000-02:00",
  "records" : [ {
    "from" : "2013-11-18T18:38:30.252-02:00",
    "to" : "2013-11-18T18:38:56.942-02:00"
  }, {
    "from" : "2013-11-18T18:39:08.321-02:00",
    "to" : "2013-11-18T18:39:10.080-02:00"
  } ]
} ]

```

Getting records for a month (shows days of September at which there are records):

GET <http://127.0.0.1:8085/web2/secure/archive/CAM:2/2011-12/>

XML:

```

<?xml version="1.0" encoding="UTF-8"?>
<days>
  <day>
    <id>2011-09-02T00:00:00-05:00</id>
  </day>
  <day>
    <id>2011-09-03T00:00:00-05:00</id>
  </day>
  <day>
    <id>2011-09-05T00:00:00-05:00</id>
  </day>

```

```
</days>
```

JSON:

```
[ {
  "id" : "2011-09-01T00:00:00-0500",
  "records" : [ ]
}, {
  "id" : "2011-09-03T00:00:00-0500",
  "records" : [ ]
}, {
  "id" : "2011-09-01T00:00:00-0500",
  "records" : [ ]
} ]
```

If there are no records, the following will be received:

XML:

```
[<days/>
JSON:
[]
```

### 13.13.3 Getting video from archive - "arc.play"

General request format:

```
GET http://IP-address:port/web2/secure/video/action.do?version={version}&sessionid={sessionid}
&video_in={video_in}&command=arc.play&time_from={time_from}&time_to={time_to}&login={login}
&password={password}&speed_factor={speed_factor}
```

Request parameters:

Parameter	Required	Description
version	Yes	See <a href="#">Product version</a>
sessionid	No	Session ID
video_in	Yes	Camera ID in the format "TYPE:ID", for example "CAM:1"
command	Yes	Command to get video from archive: arc.play
time_from	Yes	Start time of archive playing back
time_to	No	Completion time of archive playing back (if parameter is not specified, all archive will playback)

Parameter	Required	Description
imageWidth	No	Width in pixels (it is counted automatically with saving proportions if it isn't specified or equal 0)
imageHeight	No	Height in pixels (it is counted automatically with saving proportions if it isn't specified or equal 0)
fps	No	Maximal frame per second (if it isn't specified or equal 0, frame frequency won't be limited)
login	No	<i>Axxon PSIM</i> username, if set
password	No	<i>Axxon PSIM</i> user password, if set
speed_factor	No	Sets the playback speed. The value may be any integer or fractional number no less than 0. Examples of values: 0 – playback at the highest possible speed (depends on network bandwidth and disk load) 1 – playback at normal speed x1 (default) 0.1 – slow motion playback at x1/10 speed 2 – fast playback at x2 speed
format	No	Sets the response format (see <a href="#">General information on HTTP API</a> )

**Request example:**

```
GET http://127.0.0.1:8085/web2/secure/video/action.do?
version=4.9.0.0&sessionId=29101F1&video_in=CAM:5&
command=arc.play&time_from=2013-03-22T13:04:52.312+04:00&time_to=2013-03-22T13:16:31.873+04:00&
login=USER&password=PASS&speed_factor=1
```

**Response example:**

End packet with newstate=closed and errcode=100 will be received when stream completion.

**Note**

The request can be executed through the web or in the VLC media player.

### 13.13.4 Getting one frame from archive - "arc.frame"

**General request format (1st way):**

```
GET http://IP-address:port/web2/secure/video/action.do?version={version}&sessionId={sessionId}
&video_in={video_in}&command=arc.frame&time={time}&range={range}&login={login}&password={password}
```

## Request parameters:

Parameter	Is required	Description
version	Yes	See <a href="#">Product version</a>
sessionid	No	Session ID
video_in	Yes	Camera ID in the format "TYPE:ID", for example "CAM:1"
command	Yes	Command to get video from archive: arc.frame
time	Yes	Frame time
range	No	Time in seconds to specify search range of the nearest frame relatively the time parameter (the nearest frame all over archive is searched if this parameter is not specified);
imageWidth	No	Width in pixels (is counted automatically with saving proportions if it isn't specified or equal 0)
imageHeight	No	Height in pixels (is counted automatically with saving proportions if it isn't specified or equal 0)
login	No	<i>Axxon PSIM</i> username, if set
password	No	<i>Axxon PSIM</i> user password, if set

**Request example:**

GET http://127.0.0.1:8085/web2/secure/video/action.do?  
 version=4.9.0.0&sessionid=29101F1&video\_in=CAM:5&command=arc.frame&time=2013-03-22T13:04:52.312+04:00&  
 range=0.1&login=USER&password=PASS

## General request format (2nd way):

GET http://IP-address:port/action.do?version={version}&video\_in={video\_in}&command=arc.frame&time={time}

## Request parameters:

Parameter	Is required	Parameter
version	Yes	See <a href="#">Product version</a>

Parameter	Is required	Parameter
video_in	Yes	Camera ID in the format "TYPE:ID", for example "CAM:1"
command	Yes	Command to get video from archive: arc.frame
time	Yes	Frame time

**Request example:**

GET http://127.0.0.1:80/action.do?  
version=4.9.0.0&video\_in=CAM:1&command=arc.frame&time=2018-08-12T22:29:06Z

**Response example:**

<b>Request Details</b> <a href="#">permalink</a> <a href="#">raw</a>		<b>Headers</b>	
<b>POST</b>	http://webhook.site/4589bc86-e597-41d3-aab8-a93b09e977a8	connection	close
<b>Host</b>	159.69.14.138 <a href="#">whois</a>	x-forwarded-for	159.69.14.138
<b>Date</b>	2019-06-14 12:44:40	user-agent	Apache-HttpClient/4.1.4 (Java/1.8.0_201)
<b>ID</b>	1d1d0274-ddb1-409b-bb75-dc950a12265d	host	webhook.site
		content-type	application/json; charset=UTF-8
		content-length	369
<b>Query strings</b>	(empty)	<b>Form values</b>	(empty)
<pre>SubscriptionEvent(   action=ALARM_EVENT,   uniqueUUID={59321A11-A28E-E911-9D70-1C1B0DE94CFB},   time=Fri Jun 14 15:43:54 MSK 2019,   params=Params(     additionalDataString=     [{"name":"incident","value":"264400"}, {"name":"picture","value":"http://172.17.11.11:8095/action.do?version=4.9.0.0&amp;video_in=CAM:8&amp;command=arc.frame&amp;time=2019-06-14T15:43:54Z"}]   ),   cameraCode=8 )</pre>			

In return http-headings and the nearest frame from the [time - range, time + range] range in the jpeg format will be received. The reply body will be empty if there is no frame in the range.

## 13.14 Sound

### 13.14.1 Getting live sound

General request format:

GET http://IP-address:port/web2/secure/video/action.do?version={version}&sessionid={sessionid}  
&command=audio.play&audio\_in={audio\_in}&format={format}&login={login}&password={password}

Request parameters:

Parameter	Is required	Description
version	Yes	See <a href="#">Product version</a>
sessionid	No	Session ID
command	Yes	Command to getting live sound: <b>audio.play</b>
format	Yes	Format of audio data
audio_in	Yes	Microphone ID in the format "TYPE:ID", for example "MIC:1"
login	No	<i>Axxon PSIM</i> username, if set
password	No	<i>Axxon PSIM</i> user password, if set

### Request example:

```
GET http://127.0.0.1:8085/web2/secure/video/action.do?
version=4.9.0.0&sessionid=FC126734&command=audio.play&audio_in=MIC:5&format=L16&login=USER&password
=PASS
```

### Response example:

Audio packets of the following view will be received:

```
HTTP/1.0 200 OK
Connection: close
Server: AxxonSoft-PSIM-Webserver/4.9.0.0
Cache-Control: no-store,no-cache,must-revalidate,max-age=0
Pragma: no-cache
Date: Mon, 13 Jan 2013 10:44:27 GMT
Content-Type: multipart/mixed;boundary=audioframe

--audioframe
Content-Type: text/xml
Content-Length: 138

<audio_in>
  <sessionid>FC126734</sessionid>
  <audio_in>MIC:5</audio_in>
  <newstate>started</newstate>
  <errcode>100</errcode>
</audio_in>
--audioframe
Content-Type: audio/L16;rate=8000;channels=1
```

```

Content-Length: 1024
X-Time: 2013-03-22T13:16:31.371+04:00

<audio packet PCM16>
--audioframe
Content-Type: audio/L16;rate=8000;channels=1
Content-Length: 1278
X-Time: 2013-03-22T13:16:31.873+04:00
<audio packet PCM16>

```

## 13.14.2 Stop streaming live sound

General request format:

```
GET http://IP-address:port/web2/secure/video/action.do?version={version}&sessionid={sessionid}
&command=audio.stop&audio_in={audio_in}&login={login}&password={password}
```

Request parameters:

Parameter	Is required	Description
version	Yes	See <a href="#">Product version</a>
sessionid	No	Session ID
command	Yes	Command to stop streaming live sound: <b>audio.stop</b>
audio_in	Yes	Microphone ID in the format "TYPE:ID", for example "MIC:1"
login	No	<i>Axxon PSIM</i> username, if set
password	No	<i>Axxon PSIM</i> user password, if set

### Request example:

```
GET http://127.0.0.1:8085/web2/secure/video/action.do?
version=4.9.0.0&sessionid=29101F1&command=audio.stop&audio_in=MIC:5&login=USER&password=PASS
```

### Response example:

The end xml packet will be received:

```

--audioframe
Content-Type: text/xml

```

```
Content-Length: 106
<audio_in>
  <sessionid>FC126734</sessionid>
  <audio_in>MIC:5</audio_in>
  <newstate>closed</newstate>
  <errcode>100</errcode>
</audio_in>
```

### 13.14.3 Playing sound from archive

General request format:

```
GET http://IP-address:port/web2/secure/video/action.do?version={version}&sessionid={sessionid}
&command=arc.play&audio_in={audio_in}&format={format}&time_from={time_from}&time_to={time_to}
&login={login}&password={password}
```

Request parameters:

Parameter	Is required	Description
version	Yes	See <a href="#">Product version</a>
sessionid	No	Session ID
command	Yes	Command to playing sound from archive: <b>arc.play</b>
format	Yes	Format of audio data
audio_in	Yes	Microphone ID in the format "TYPE:ID", for example "MIC:1"
time_from	Yes	Start time of archive playing back
time_to	Yes	End time of archive playing back
login	No	<i>Axxon PSIM</i> username, if set
password	No	<i>Axxon PSIM</i> user password, if set

#### Request example:

```
GET http://127.0.0.1:8085/web2/secure/video/action.do?
version=4.9.0.0&sessionid=29101F1&command=arc.play&audio_in=MIC:5&format=L16&time_from=2013-03-22T13:
16:31.873+04:00&time_to=2013-03-22T13:04:52.312+04:00&login=USER&password=PASS
```

**Response example:**

The stream will be received in the same view as in case of live sound (see [Getting live sound](#)). The end xml packet will be received when data completion (as when getting live sound (see [Stop streaming live sound](#))).

### 13.14.4 Sending live sound

**General request format:**

POST http://IP-address:port/web2/secure/video/action.do?version={version}&sessionid={sessionid}&command=audio.receive&audio\_out={audio\_out}&login={login}&password={password}

**Request parameters:**

Parameter	Is required	Description
version	Yes	See <a href="#">Product version</a>
sessionid	No	Session ID
command	Yes	Command to sending live sound: <b>audio.receive</b>
audio_out	Yes	Speaker ID in the format "TYPE:ID", for example "SPEAKER:1"
login	No	<i>Axxon PSIM</i> username, if set
password	No	<i>Axxon PSIM</i> user password, if set

**Request example:**

POST http://127.0.0.1:8085/web2/secure/video/action.do?  
version=4.9.0.0&sessionid=FC126734&command=audio.receive&audio\_out=SPEAKER:3&login=USER&password=PASS

**Response example:**

Sending of sound is performed by serial communication of packets using commands:

```
Content-type: audio/L16;rate=8000;channels=1
Connection: keep-alive
```

Then audio packet transmission will perform.

Response parameters:

Parameter	Description
L16	Format of sound – only L16
rate	Any rational value
channels	Channel from 1 to 6

## 13.15 Get list of users

### 13.15.1 General request format:

GET http://IP-address:port/web2/secure/persons

### 13.15.2 Request example:

GET http://127.0.0.1:8085/web2/secure/persons

### 13.15.3 Response example:

```
{
  "PERSON":
  {
    "external_id":
    {
      "type": "VarChar",
      "value": ""
    },
    "auto_pass_type":
    {
      "type": "Integer",
      "value": ""
    },
    "rubeg8_zone_id":
    {
      "type": "VarChar",
      "value": ""
    },
    "levels_times":
    {
      "type": "LongVarChar",
      "value": ""
    },
    "expired":
    {
      "type": "VarChar",
      "value": ""
    },
  },
}
```

```

"card_date":
{
  "type": "VarChar",
  "value": "19.03.2021 15:34:07"
},
"who_level":
{
  "type": "VarChar",
  "value": ""
},
"visit_purpose":
{
  "type": "VarChar",
  "value": ""
},
"level2_id":
{
  "type": "VarChar",
  "value": ""
},
"card":
{
  "type": "VarChar",
  "value": ""
},
"objname":
{
  "type": "VarChar",
  "value":
"\u00CF\u00EE\u00EB\u00FC\u00E7\u00EE\u00E2\u00E0\u00F2\u00E5\u00EB\u00FC 1"
},
"email":
{
  "type": "VarChar",
  "value": ""
},
"area_id":
{
  "type": "VarChar",
  "value": ""
},
"who_card":
{
  "type": "VarChar",
  "value": ""
},
"surname":
{
  "type": "VarChar",
  "value": ""
},
"facility_code":

```

```

{
  "type": "VarChar",
  "value": ""
},
"card_loss":
{
  "type": "Integer",
  "value": ""
},
"auto_brand":
{
  "type": "VarChar",
  "value": ""
},
"when_area_id_changed":
{
  "type": "DBTimeStamp",
  "value": ""
},
"post":
{
  "type": "VarChar",
  "value": ""
},
"drivers_licence":
{
  "type": "VarChar",
  "value": ""
},
"temp_levels_times":
{
  "type": "LongVarChar",
  "value": ""
},
"temp_level_id":
{
  "type": "LongVarChar",
  "value": ""
},
"temp_card":
{
  "type": "VarChar",
  "value": ""
},
"patronymic":
{
  "type": "VarChar",
  "value": ""
},
"location":
{
  "type": "VarChar",

```

```
    "value": ""
  },
  "teleph_work":
  {
    "type": "VarChar",
    "value": ""
  },
  "department":
  {
    "type": "VarChar",
    "value": ""
  },
  "parent_id":
  {
    "type": "VarChar",
    "value": "1"
  },
  "tabnum":
  {
    "type": "VarChar",
    "value": ""
  },
  "pur":
  {
    "type": "Integer",
    "value": ""
  },
  "finished_at":
  {
    "type": "DBTimeStamp",
    "value": ""
  },
  "all_param":
  {
    "type": "VarChar",
    "value": ""
  },
  "whence":
  {
    "type": "VarChar",
    "value": ""
  },
  "schedule_id":
  {
    "type": "VarChar",
    "value": ""
  },
  "person":
  {
    "type": "VarChar",
    "value": ""
  },
  },
```

```
"passport":
{
  "type": "VarChar",
  "value": ""
},
"ngp":
{
  "type": "Integer",
  "value": ""
},
"flags":
{
  "type": "Integer",
  "value": ""
},
"auto_number":
{
  "type": "VarChar",
  "value": ""
},
"pin":
{
  "type": "VarChar",
  "value": ""
},
"phone":
{
  "type": "VarChar",
  "value": ""
},
"begin_temp_level":
{
  "type": "VarChar",
  "value": ""
},
"visit_document":
{
  "type": "VarChar",
  "value": ""
},
"visit_birthplace":
{
  "type": "VarChar",
  "value": ""
},
"is_apb":
{
  "type": "SmallInt",
  "value": "0"
},
"end_temp_level":
{
```

```

    "type": "VarChar",
    "value": ""
  },
  "name":
  {
    "type": "VarChar",
    "value":
"\u00CF\u00EE\u00EB\u00FC\u00E7\u00EE\u00E2\u00E0\u00F2\u00E5\u00EB\u00FC 1"
  },
  "started_at":
  {
    "type": "DBTimeStamp",
    "value": ""
  },
  "level_id":
  {
    "type": "LongVarChar",
    "value": ""
  },
  "_marker":
  {
    "type": "LongVarChar",
    "value": ""
  },
  "where_area_id_ap_type":
  {
    "type": "VarChar",
    "value": ""
  },
  "owner_person_id":
  {
    "type": "VarChar",
    "value": ""
  },
  "is_locked":
  {
    "type": "SmallInt",
    "value": "0"
  },
  "is_active_temp_level":
  {
    "type": "SmallInt",
    "value": "0"
  },
  "guid":
  {
    "type": "GUID",
    "value": "{676A1F65-AF88-EB11-9633-1831BF4C3BFA}"
  },
  "card_type":
  {
    "type": "Integer",

```

```

    "value": ""
  },
  "begin":
  {
    "type": "VarChar",
    "value": ""
  },
  "where_area_id_ap_id":
  {
    "type": "VarChar",
    "value": ""
  },
  "visit_reg":
  {
    "type": "VarChar",
    "value": ""
  },
  "marketing_info":
  {
    "type": "LongVarChar",
    "value": ""
  },
  "comment":
  {
    "type": "LongVarChar",
    "value": ""
  },
  "ad_guid":
  {
    "type": "GUID",
    "value": ""
  },
  "id": "1"
}

```

## 13.16 Commands used for ECHD integration

ECHD means ‘Unified data center’ state information system.

The description of http requests that are used for integration of *Axxon PSIM* with ECHD is given in this section. For requests operation they are to be enabled at the stage of system configuration – see [Enabling the processing of SDC \(ECHD\) requests and selecting the RTSP server](#).

Requests are sent to **Web Server** and are performed only for cameras under which the **ECHD channel** object is created.

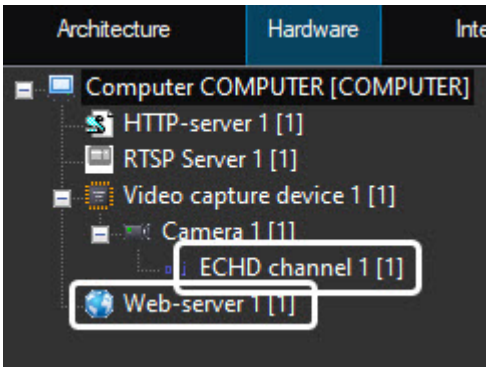

### 13.16.1 Retrieving Device Information

General request format:

GET http://IP-address:port/getdeviceinfo

**Request example:**

GET http://127.0.0.1:80/getdeviceinfo

**Response example:**

```
{
  "firmware version": "1.2.3 Rev B.",
  "vendor": "Vendor Title Ltd"
  "model": "Device Model",
  "serial_number": "12345ABCDEF",
  "ptz-status": "not supported"
}
```

**Response parameters:**

Parameter	Description
firmware version	Firmware version. Any prefix can be added to the firmware version value returned by the AdditionalVersionString registry key – see <a href="#">Registry keys reference guide</a> .
vendor	Manufacturer
model	Model
serial_number	Serial number
ptz-status	PTZ support

### 13.16.2 Getting a list of camera IDs

General request format:

GET http://IP-address:port/getcameras

**Request example:**

GET http://127.0.0.1:80/getcameras

Response **example:**

```
{
  "cameras": [
    {
      "id": 1,
      "channel": 1,
      "status": "working"
    },
    {
      "id": 2,
      "channel": 2,
      "status": "signalLost"
    }
  ]
}
```

**Response parameters:**

Parameter	Description
id	Camera ID
channel	Camera channel
status	Camera status

### 13.16.3 Ranges of available archive recordings

General request format:

GET http://IP-address:port/getarchiveranges?cameraid={cameraid}

or

GET http://IP-address:port/getavailablearchiveranges?cameraid={cameraid}

Request parameters:

Parameter	Is required	Description
cameraid	Yes	Camera ID

### Request example:

GET http://127.0.0.1:80/getarchiveranges?cameraid=1

### Response example:

Returns time periods over which archive recordings from the specified video surveillance device are available. By default fragments are merged if the interval between them is less than 5 seconds. This time period can be changed using the SplitArchiveIntervals registry key (see [Registry keys reference guide](#)).

```
{
  "cameraid": 1,
  "ranges": [
    {
      "from": 1412121600, //unixtime
      "to": 1412172000
    },
    {
      "from": 1412186400,
      "to": 1412188200
    }
  ]
}
```

## 13.16.4 Working with video streams

### GetArchiveURL request

GetArchiveURL – returns rtsp URL of archive video stream received from video encoder for the specified camera starting from FromDateTime (and, optionally, ending at endDatetime).

General request format:

GET http://IP-address:port/getarchiveurl?cameraid={cameraid}&fromdatetime={fromdatetime}&todatetime={todatetime}

Request parameters:

Parameter	Is required	Description
cameraid	Yes	Camera ID
fromdatetime	Yes	Start time of the archive fragment in the format YYYY-MM-DDTHH:MM:SS
todatetime	No	End time of the archive fragment in the format YYYY-MM-DDTHH:MM:SS (if not specified, the entire archive will be given until the last record)

**Request example:**

GET http://127.0.0.1:80/getarchiveurl?  
cameraid=1&fromdatetime=2014-10-01T00:00:00&todatetime=2014-10-01T01:20:05

Response **example:**

```
{
  "rtspurl": "rtsp://deviceaddress/somearchivemediastream?somedatetimetoken"
}
```

### GetLiveUrl request

GetLiveUrl – returns rtsp URL of “live” video stream for the specified camera.

General request format:

GET http://IP-address:port/getliveurl?cameraid={cameraid}

Request parameters:

Parameter	Is required	Description
cameraid	Yes	Camera ID

**Request example:**

GET http://127.0.0.1:80/getliveurl?cameraid=1

Response **example:**

```
{
  "rtspurl": "rtsp://device-address/somelivemediastream0"
}
```

## 13.16.5 Archive downloading

General request format:

```
GET http://IP-address:port/downloadarchivefile?cameraid={cam_id}&fromdatetime={from_time}
&todatetime={to_time}
```

Request parameters:

Parameter	Is required	Description
cam_id	Yes	Camera ID
from_time	Yes	The start time of the archive fragment in the format YYYY-MM-DDTHH:MM:SS
to_time	Yes	The end time of the archive fragment in the format YYYY-MM-DDTHH:MM:SS

Request example:

```
GET http://127.0.0.1:80/downloadarchivefile?
cameraid=1&fromdatetime=2014-10-01T00:00:00&todatetime=2014-10-01T01:20:05
```

Response example:

```
HTTP/1.1 200 OK
Content-Type: application/octet-stream
```

Also, as a result of the command, a file with the .es extension will be received (for example, Camera [4] (2019-08-13T11\_00\_00 - 2019-08-13T12\_10\_00).es). Convert this file using the ffmpeg utility to play it. This utility is available for download on the official website <https://ffmpeg.org/>

Example command to convert H.264-coded file:

```
ffmpeg -i "C:\path to the .264 file\Camera[5].es" -c:v copy -bsf:v h264_mp4toannexb -c:a copy -f avi output.avi
```

Example command to convert H.265-coded file:

```
ffmpeg -i "C:\path to the .265 file\Camera[5].es" -c:v copy -bsf:v hevc_mp4toannexb -c:a copy -f avi output.avi
```

The .avi file (output.avi) is created after this command execution.

## 13.16.6 Archive export

Creating archive export request

By default, the archive is exported in mp4 format. Change the format using the ExportContainerFormat registry key (see [Registry keys reference guide](#)). The export of the archive in H.264 or MPEG4 formats is supported.

General request format:

POST http://IP-address:port/createarchivetask

```
Content Type: application/json
Content:
{
  "CameraId": "{CameraId}",
  "From": "{From}",
  "To": "{To}"
}
```

Request parameters:

Parameter	Is required	Description
CameraId	Yes	Camera ID
From	Yes	The start time of the archive fragment in the UTC format YYYY-MM-DDTHH:MM:SS
To	No	The end time of the archive fragment in the UTC format YYYY-MM-DDTHH:MM:SS (if not specified, the entire archive will be given up to the last record)

**Request example:**

POST http://127.0.0.1:80/createarchivetask

```
Content Type: application/json
Content:
{
  "CameraId": "1",
  "From": "2016-06-27T15:10:00.00Z",
  "To": "2016-06-27T15:20:00.00Z"
}
```

Response **example:**

The folder with the corresponding name (084b56a5-bd49-4327-82db-9bc911f7ff96) and mp4 file inside it is created in the export folder (by default C:\Users\User\Documents\Axxon PSIM\export).

```
{
  "CameraId" : "1",
  "From" : "2016-06-27T15:10:00.00Z",
  "To" : "2016-06-27T15:20:00.00Z",
```

```

"ArchiveTaskId" : "084b56a5-bd49-4327-82db-9bc911f7ff96",
"ErrorMessage" : null,
"State" : "Created"
}

```

**Response example:**

Parameter	Description
CameraId	Camera ID
From	The start time of the archive fragment in the UTC format YYYY-MM-DDTHH:MM:SS
To	The end time of the archive fragment in the UTC format YYYY-MM-DDTHH:MM:SS
ArchiveTaskId	Task ID
ErrorMessage	Error messages
State	Task creation result

**Getting export status**

General request format:

GET http://IP-address:port/getarchivetaskstatus?archivetaskid={archivetaskid}

Request parameters:

Parameter	Is required	Description
archivetaskid	Yes	Task ID

**Request example:**

GET http://127.0.0.1:80/getarchivetaskstatus?archivetaskid=104b38d4-07d7-4d2f-84da-49b3e255d2bf

Response **example:**

```

{
  "Percents" : 100,
  "Url" : "http://192.168.15.182:80/download?
file=104b38d4-07d7-4d2f-84da-49b3e255d2bf",
  "CameraId" : "1",
  "From" : "2016-06-27T15:10:00.000+03:00",
  "To" : "2016-06-27T15:11:00.000+03:00",

```

```

"ArchiveTaskId" : "104b38d4-07d7-4d2f-84da-49b3e255d2bf",
"ErrorMessage" : "null",
"State" : "ReadyForDownload"
}

```

**Response parameters:**

Parameter	Description
Percents	Percentage of task completion
Url	Link to mp4 file. The required mp4 file can be downloaded using this URL link
CameraId	Camera ID
From	The start time of the archive fragment in the format YYYY-MM-DDTHH:MM:SS
To	The end time of the archive fragment in the format YYYY-MM-DDTHH:MM:SS
ArchiveTaskId	Task ID
ErrorMessage	Error messages
State	Task creation result

**Deleting archive**

General request format:

DELETE http://IP-address:port/removearchive?archivetaskid={archivetaskid}

Request parameters:

Parameter	Is required	Description
archivetaskid	Yes	Task ID

**Request example:**

DELETE http://127.0.0.1:80/removearchive?archivetaskid=084b56a5-bd49-4327-82db-9bc911f7ff96

Response **example:**

```

{
"ArchiveTaskId" : "084b56a5-bd49-4327-82db-9bc911f7ff96",
"ErrorMessage" : null,
"Success" : true
}

```

```
}

```

**Response** parameters:

Parameter	Description
ArchiveTaskId	Task ID
ErrorMessage	Error messages
Success	Archive deletion result

The corresponding folder with mp4 file will be deleted from the export folder.

### 13.16.7 Video surveillance device features management

**⚠ Important!**

Disable the **Use device settings** checkbox in order to change the manage parameters by the below commands – see [The Settings panel of the Video capture device object](#).  
 A camera must support the same commands for features management as the given ECHD commands (both when connected via ONVIF and via the corresponding driver).

General request format:

GET https://IP-address:port/?cameraID={1}&ip={2}&loqin={3}&pass={4}&action={5}&x={6}&y={7}&z={8}&modelName={9}

Request parameters:

Parameter	Is required	Description
1	Yes	ID of video surveillance device.
2	No	IP address of video surveillance device.
3	No	account of video surveillance device.
4	No	access password to video surveillance device.

Parameter	Is required	Description
5	Yes	<p>Command name:</p> <p><b>degresmove</b> – discrete motion. Atomic shift of video surveillance device in the specified direction.</p> <p><b>degresmove2</b> – relative motion.</p> <p>Rotation of video surveillance device compared with current position. Viewing area of video surveillance device is divided by a grid where central point's coordinates are (x:0, y:0), top left (x:-7, y:7), bottom right (x:7, y:-7). Video surveillance device must be rotated in a way that object appears in the center of the grid.</p> <p>'Optical' error caused by the distance to the visible object is allowed.</p> <p>Error caused by sphere-to-plane projection must be compensated.</p> <p>Depending on camera, registry keys may have to be set for correct operation:</p> <ol style="list-style-type: none"> <li>1. The camera does not support Point&amp;Click but supports absolute PTZ. Set the ReplacePointAndClick registry key to 1 (see <a href="#">Registry keys reference guide</a>).</li> <li>2. The camera supports Point&amp;Click. Set the ReplacePointAndClick registry key to 0 and TelemetryCommandMoveTimeout to delay in milliseconds between panning/tilting and zooming (see <a href="#">Registry keys reference guide</a>).</li> </ol> <p><b>setposition</b> – setting position of video surveillance device in degrees compared with '0' position.</p> <p><b>getposition</b> – getting position of video surveillance device in pAN and TILt in degrees as well as current zoom values.</p> <p><b>focus</b> – video surveillance device's focus control command where z parameter controls over focus:</p> <p>1: Focus in</p> <p>-1 : Focus out</p> <p>0: Auto</p> <p><b>iris</b> – video surveillance device's iris control command where z parameter controls over iris:</p> <p>1: Open iris</p> <p>-1: Close iris</p> <p>0: Auto</p> <p><b>switch_day_night</b> – switch day/night mode where z parameter enables one of the following modes:</p>

Parameter	Is required	Description
		<p>1: Day mode -1 : Night mode</p> <p><b>backlight</b> – switch backlight on/off where z parameter controls over the mode: 1: Enable -1: Disable</p> <p><b>switch_color</b> – the following operation modes of video surveillance device are set by z parameter: 1: Enable -1: Disable</p>
6	No	<p>In <b>degreesmove</b>, <b>setposition</b> commands: PAN rotation [-180 ..0.. 180].</p> <p>In <b>degreesmove2</b>: PAN rotation [-7..0..7].</p> <p>In <b>getposition</b>: not in use.</p> <p>In commands <b>focus</b>, <b>iris</b>, <b>switch_day_night</b>, <b>backlight</b>, <b>switch_color</b>: set value 0 to the parameter.</p>
7	No	<p>In <b>degreesmove</b>, <b>setposition</b> commands: TILT rotation [-180 ..0.. 180].</p> <p>In <b>degreesmove2</b>: TILT rotation [-7..0..7].</p> <p>In <b>getposition</b>: not in use.</p> <p>In commands <b>focus</b>, <b>iris</b>, <b>switch_day_night</b>, <b>backlight</b>, <b>switch_color</b>: set value 0 to the parameter.</p>
8	No	<p>In <b>degreesmove</b>, <b>degreesmove2</b>, <b>setposition</b> commands: zoom in/out [0.. 100].</p> <p>In <b>getposition</b>: not in use.</p> <p>In commands <b>focus</b>, <b>iris</b>, <b>switch_day_night</b>, <b>backlight</b>, <b>switch_color</b>: set device mode, see description of the corresponding command above.</p>
9	No	Model of video surveillance device.

## Request example:

GET http://127.0.0.1:80/execute?cameraID=7&amp;action=getposition

Response example:

Response comes on `getposition` command only. Example in JSON format:

```
{"y":56, "x":105, "z":0}
```

Response parameters:

Parameter	Description
x	PAN coordinate
y	TILT coordinate
z	Zoom value

### 13.16.8 Example ECHD commands with NAT

Go to the **RTSP Server** and **Web server** objects setting panels to enable and configure NAT (see [Configuring RTSP Server module](#) and [Enabling the processing of ECHD requests and selecting the RTSP server](#)).

For example, the following NAT parameters are specified on the **RTSP Server** object settings panel:

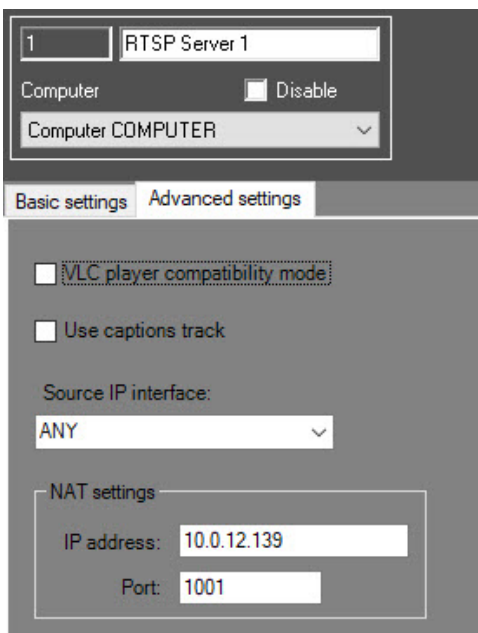

10.0.12.139 – router IP address.

1001 – router port.

192.168.0.109 – Server address in local network.

559 – RTSP Server port.

80 – Web Server port.

General request format:

```
GET http://IP-address:port/getliveurl?cameraid={cameraid}
```

Request parameters:

Parameter	Is required	Description
cameraid	Yes	Camera ID

### Request example:

GET `http://127.0.0.1:80/getliveurl?cameraid=1`

### Response example:

If the **Use NAT address** checkbox on the **Web server** object setting panel is UNchecked, then:

```
{
  "rtspurl": "rtsp://127.0.0.1:559/archive?id=1"
}
```

If the **Use NAT address** checkbox on the **Web server** object setting panel is checked, then:

```
{
  "rtspurl": "rtsp://10.0.12.139:1001/archive?id=1"
}
```

Response parameters:

Parameter	Description
id	Camera ID

## 13.17 Sending reactions, events or XML data to Axxon PSIM with HTTP API

### 13.17.1 Sending reactions to Axxon PSIM via HttpListener

In order to send reactions to *Axxon PSIM* via `HttpListener`, create the **Video Capture Device** object on the basis of the **Computer** object on the **Hardware** tab of the **System settings** dialog box. Then select **HttpListener** in the **Type** field and set connection port in the **Port** field. Create no more than 4 **Sensor** objects on the basis of this **Video Capture Device** object.

`HttpListeners` only allows sending close/open reactions to a normally opened/closed `Sensor`. In 2 seconds after the command execution, the sensor goes back to its normal state. Macros or scripts can be configured in *Axxon PSIM* to handle sensor triggering.

**General request format:**

POST http://IP-address:port/device/id/{id}

```
{"state": "{state}"}
```

**Request parameters:**

Parameter	Required	Description
Port	Yes	HttpListener port (corresponds to the port number specified in the Web server settings)
id	Yes	Sensor ID: 0/1/2/3
state	Yes	Sensor state: <ul style="list-style-type: none"> <li>• <b>opened</b> – Open</li> <li>• <b>closed</b> – Close</li> </ul>

**Request example:**

POST http://127.0.0.1:8085/device/id/0

```
{"state": "closed"}
```

### 13.17.2 Sending events on scanned barcode

The HTTP API allows sending events to *Axxon PSIM* from a mobile application with the information received from a scanned barcode.

**General request format:**

POST http://IP-address:port/web2/secure/barcode/

```
{ "value": "value", "img":"img" }
```

**Request parameters:**

Parameter	Is required	Description
value	Yes	Barcode number

Parameter	Is required	Description
img	No	Identifier of the scanned image

Request example:

http://1:1@127.0.0.1:8085/web2/secure/barcode

```
{ "value": "321", "img":"6835" }
```

Response example:

```
Event : WEB2|1|WEB2_BARCODE|SLAVE_id<Computer>,fraction<243>,owner<Tester>,date<03-12-21>,guid_pk<{96CC2A50-3F54-EC11-B93B-F02F74F7DC0D}>,core_global<1>,barcode<321>,img<6835>,time<16:45:53>
```

### 13.17.3 Sending reactions and events to Axxon PSIM using HTTP request

When getting such commands, standard events and reactions will be generated in *Axxon PSIM*. They can be used in scripts and macros (see [Creating and using macros](#) and [Programming Guide \(JScript\)](#)).

General request format:

**Note.**

Create and configure the **Web server** object in order to use these requests – see [Creating the Web-server object](#). In the requests, it is necessary to specify the port set up in the Web server settings.

GET http://IP-address:port/psim\_core/React?command="{react}"

GET http://IP-address:port/psim\_core/Event?command="{event}"

or (with the same result)

POST http://IP-address:port/psim\_core/React HTTP/1.1

```
{
  "command" : "{react}"
}
```

POST http://IP-address:port/psim\_core/Event HTTP/1.1

```
{
  "command" : "{event}"
}
```

Request parameters:

Parameter	Required	Description
command	Yes	React – a reaction in the <i>Axxon PSIM</i> format Event – an event in the <i>Axxon PSIM</i> format

### Request example:

**Add captions to video from camera 2 via HTTP request:**

```
GET http://127.0.0.1:80/psim_core/React?command="CAM|2|ADD_SUBTITLES|command<Some text\n!>"
```

**Generate alarm on camera 2 via HTTP request:**

```
GET http://127.0.0.1:80/psim_core/Event?command="CAM|2|MD_START"
```

OR (with the same result)

```
POST http://127.0.0.1:80/psim_core/Event HTTP/1.1
{
  "command" : "CAM|2|MD_START"
}
```

**Run Macro 1 via HTTP request:**

```
GET http://127.0.0.1:80/psim_core/React?command="MACRO|1|RUN"
```

**Start recording on Camera 1:**

```
POST http://127.0.0.1:80/psim_core/React HTTP/1.1
{
  "command" : "CAM|1|REC"
}
```

## 13.17.4 Sending HTTP API commands using curl tool

To test HTTP API one can send HTTP API commands using curl tool. This tool is available at <https://curl.haxx.se/>.

To use the tool start the Windows command line and go to <curl installation directory>\curl-7.46.0-win64\bin folder.

**Request example:**

Find the example of the command to create the archive export task below as in the case of a request to a Single Data Center (see [Archive export](#)):

```
curl -H "Content-Type: application/json" -X POST -d '{"CameraId": "1", "From": "2017-12-26T10:58:00.00Z", "To": "2017-12-26T11:00:00.00Z"}' http://127.0.0.1:80/createarchivetask
```

**Response example:**

```
{
  "CameraId" : "1", "From" : "2017-12-26T10:58:00.00Z", "To" :
  "2017-12-26T11:00:00.00Z", "ArchiveTaskId" : "084b56a5-bd49-4327-82db-9bc911f7ff96",
  "ErrorMessage" : null, "State" : "Created"
}
```

**Note**

In the requests, it is necessary to specify the port set up in the Web server settings — see [Configuring the Web-server module](#).

### 13.17.5 Sending XML file

The HTTP API allows receiving data in XML format for further processing in scripts. To send a file, perform a POST request.

**General request format:**

POST http://IP-address:port/psim\_core/{Any}

```
<tag1>
  <tag2>some_data</tag2>
  <tag3>another_data</tag3>
</tag1>
```

**Request parameters:**

Parameter	Required	Description
Any	Yes	Any set of valid characters can be specified, except for Event and React, for example: <ul style="list-style-type: none"> <li>http://127.0.0.1:8080/psim_core</li> <li>http://127.0.0.1:8080/psim_core/Any</li> <li>http://127.0.0.1:8080/psim_core/Custom</li> </ul>

**Note**

In the requests, it is necessary to specify the port set up in the Web server settings — see [Configuring the Web-server module](#).

Request example:

POST http://127.0.0.1:8080/psim\_core/Any

```
<tag1>
  <tag2>some_data</tag2>
  <tag3>another_data</tag3>
</tag1>
```

Response example:

After receiving the data in XML format in *Axxon PSIM*, the following event is generated:

HTTP|1|CUSTOM\_EVENT|url</psim\_core/Any>,owner<SLAVE-ID>,data<PG5..90ZT4=>

Response parameters:

Parameter	Description
data	Request body (XML in the example above) base64-encoded
url	Part of the posted url

## 13.18 Configuring the Technoserv integration

Create and configure the following objects and files in order to configure the Technoserv integration:

1. **Web-server** – see [Configuring the videosever to connect Clients via the Web-server module](#).
2. **Web-server 2.0** – see [Configuring the server for the clients connection via the Web server 2.0 module](#).
3. At least one **User** object added to **User permissions**. The Technoserv connection with *Axxon PSIM* will be established under this user's credentials. See [Rights administration](#).
4. Enable filter for camera and detection tool events on the **Web-server 2.0** object settings panel – see [Configuring the Events filter for the Web server 2.0 module](#).
5. Add all cameras to get events from to the Web-server configuration – see [Selecting and configuring cameras for the Web-server module](#).
6. Fill in the ApiBgConfig.xml configuration file, then put it to "<Axxon PSIM installation path>\Modules\Jetty\". See [Filling in the ApiBgConfig.xml configuration file](#).

See also [Examples of commands to work with the Technoserv integration](#).

### 13.18.1 Filling in the ApiBgConfig.xml configuration file

The ApiBgConfig.xml file is used to configure the login and password for connecting the Technoserv system to *Axxon PSIM*, as well as for associating *Axxon PSIM* events with the Technoserv event codes (see the table below).

The file has the following format:

```
<ApiBgEventsConfiguration>
  <PingTimeout>120000</PingTimeout>
  <MainHost>127.0.0.1</MainHost>
  <Login></Login>
  <Password></Password>
  <ApiBgEventMatch>
    <ProductObjectName>CAM</ProductObjectName>
    <ProductEventName>DETACHED</ProductEventName>
    <ApiBgEventCode>not_available</ApiBgEventCode>
  </ApiBgEventMatch>
  <ApiBgEventMatch>
    <ProductObjectName>CAM</ProductObjectName>
    <ProductEventName>ATTACH</ProductEventName>
    <ApiBgEventCode>available</ApiBgEventCode>
    <Picture>1</Picture>
  </ApiBgEventMatch>
  <ApiBgEventMatch>
    <ProductObjectName>CAM</ProductObjectName>
    <ProductEventName>ALARM</ProductEventName>
    <ApiBgEventCode>264400</ApiBgEventCode>
    <Shapes>1</Shapes>
    <Picture>1</Picture>
  </ApiBgEventMatch>
  <ApiBgEventMatch>
    <ProductObjectName>CAM</ProductObjectName>
    <ProductEventName>REC</ProductEventName>
    <ApiBgEventCode>264409</ApiBgEventCode>
    <Shapes>1</Shapes>
    <Picture>1</Picture>
  </ApiBgEventMatch>
</ApiBgEventsConfiguration>
```

1. The time in milliseconds between sending PING events  
<PingTimeout>120000</PingTimeout>
2. The IP-address to be returned on requests of Technoserv.  
<MainHost>192.168.0.171</MainHost>
3. Username and password to connect to the Technoserv server and send events (if any)  
<Login></Login> <Password></Password>
4. Correspondence of the *Axxon PSIM* event to the event code:
 

```
<ApiBgEventMatch>
  <ProductObjectName>CAM_VMDA_DETECTOR</ProductObjectName>
    <ProductEventName>ALARM</ProductEventName>
  <ApiBgEventCode>264400</ApiBgEventCode>
  <ProductObjectIds>
    <id>2</id>
  <id>1</id>
  </ProductObjectIds>
  <ParamMatch>
    <ProductEventParamName>num</ProductEventParamName>
    <ApiBgEventParamCode>NUMBER_OF_DETECTED_PEOPLE</ApiBgEventParamCode>
  </ParamMatch>
  <Shapes>1</Shapes>
  <Picture>1</Picture>
</ApiBgEventMatch>
```

  - a. ProductObjectName, ProductEventName – Axxon PSIM object and event, for example, CAM|MD\_START.
  - b. ProductObjectIds – Axxon PSIM object id, if you need to specify specific detectors. May be absent, then events will be transmitted to all detectors.
  - c. ApiBgEventCode – event code, see below.
  - d. Shapes – whether to transfer the Shapes field.
  - e. Picture – whether to send a link to the freeze frame.
  - f. ParamMatch – correspondence of the Axxon PSIM event parameter name to the event parameter. May be absent.

Event codes:

<b>Code</b>	<b>Event name</b>
1799	Crowd Detection (detect crowds, including in unauthorized places)
264393	Abandoned object detection
264383	People counter
264385	Estimated people traffic density in significant city sites
264388	Detection of moving against crowd flow
264387	Person stopped in the controlled area (with the preset stop time)
264386	Sharp acceleration of human movement
264389	Chaotic human movement (idleness)
264391	Indexing events in traffic conditions (traffic jams)
264392	Indexing of events in traffic conditions (massive accumulation of vehicles)
264390	Indexing events in traffic conditions (traffic density)
264394	Detection of crossing the forbidden zone (by human or vehicle)
264395	Disappeared object detection
264396	Responding to the passage of people in a given direction (entrance)
264397	Responding to the passage of people in a given direction (exit)
264399	Responding to the passage of people in a given direction (corridor etc.)
264398	Responding to the passage of people in a given direction (crosswalk)
264400	Appearance of a person or car in the observation zone (streets, squares, intersections, parks)
1795	Focus loss detection

<b>Code</b>	<b>Event name</b>
1797	Dirty camera lens
264403	Background change
264402	Camera shift
1796	Blind/cover detection
264401	Bare flame
287069	Target detected
siren	Siren or car alarm detected
shout	Human cry detected
klaxon	The sound of the car horn detected
voice	Human speech detected
brake	The sound of a vehicle brake detected
shockwave	A shock wave detected
shock	A bang/shot/blast detected
PING	It is used for a regular event periodicity sent to control the communication channel between the IS and the "Safe City" software and hardware complex. Value is filled as cameraCode=-1.
not_available	The camera is unavailable (there is no video stream or no connection with the camera, etc.)
available	The camera is available

## 13.18.2 Examples of commands to work with the Technoserv integration

### Getting a list of cameras

General request format:

GET http://IP-address:port/web2/secure/api/bg

#### Request example:

GET http://127.0.0.1:8085/web2/secure/api/bg

#### Note.

If in the **Additional information** field on the camera settings panel is filled in the format coords: [longitude]:[latitude]:[angle]:[azimuth]:[radius], then this data will be returned in response to the request in the corresponding parameters. See also [Additional information on camera](#).

#### Response example:

```
0:
cid: "8"
name: "Камера 8"
longitude: "50.0825508"
latitude: "14.4410435"
angle: "56"
azimuth: "223"
radius: "23"
webviewurl: "http://172.17.11.11:8095/"
streamHost: "172.17.11.11"
streamHttpPort: "8095"
available: false
```

### Get a list of subscriptions

General request format:

GET http://IP-address:port/web2/secure/api/bg/events/subscriptions

#### Request example:

GET http://127.0.0.1:8085/web2/secure/api/bg/events/subscriptions

#### Response example:

when the list is empty:

```
{"data": [], "status": "success"}
```

```
data: []
status: "success"
```

when the list has subscriptions:

```
data:
  0:
    callback: "https://webhook.site/4589bc86-e597-41d3-aab8-a93b09e977a8"
    filter:
      action: "RUN"
      type: "MACRO"
      id: "8"
    id: "63eb2852-9780-4085-bf5e-f3e5be875357"
status: "success"
```

## Create subscription

General request format:

http://IP-address:port/web2/secure/api/bg/events/subscriptions

### Request example:

POST http://127.0.0.1:8085/web2/secure/api/bg/events/subscriptions

```
{"callback":"https://webhook.site/26d15078-c405-4918-8f03-4f2a01b7580f","filter":
{"action":"RUN","type":"MACRO"},"id":"5"}
```

### Response example:

Request Details		permalink	raw	Headers	
POST	http://webhook.site/4589bc86-e597-41d3-aab8-a93b09e977a8			connection	close
Host	159.69.14.138	whois		x-forwarded-for	159.69.14.138
Date	2019-06-14 12:33:14			user-agent	Apache-HttpClient/4.1.4 (Java/1.8.0_201)
ID	7b6f8e05-0dbd-49d1-b1ff-4f2a734e7421			host	webhook.site
				content-type	application/json; charset=UTF-8
				content-length	369
Query strings				Form values	
(empty)				(empty)	
<pre>SubscriptionEvent(   action=ALARM_EVENT,   uniqueUUID={4C9E2133-9F8E-E911-9070-1C1B00E94CF8},   time=Fri Jun 14 15:23:28 MSK 2019,   params=Params(     additionalDataString=     [{"name":"incident","value":"264400"}, {"name":"picture","value":"http://172.17.11.11:8095/action.do?version=4.9.0.0&amp;video_in=CAM:8&amp;command=arc.frame&amp;time=2019-06-14T15:23:28Z"}]   ),   cameraCode=8 )</pre>					

## Delete subscription

General request format:

DELETE http://IP-address:port/web2/secure/api/bg/events/subscriptions/{sub\_id}

**Request example:**

Parameter	Is required	Description
sub_id	Yes	Subscription ID

Response **example:**

DELETE http://127.0.0.1:8085/web2/secure/api/bg/events/subscriptions/071e0159-5b2c-4bab-8ed7-42397f1b99b8

## Delete all subscriptions

General request format:

DELETE http://IP-address:port/web2/secure/api/bg/events/subscriptions/all

**Request example:**

DELETE http://127.0.0.1:8085/web2/secure/api/bg/events/subscriptions/all

## 14 Axxon PSIM HTTP-Server

### 14.1 General information on HTTP-Server

*HTTP-Server* allows you to transfer the events from *Axxon PSIM* to the third-party systems, i.e. to notify the clients about the events.

The *HTTP-Server* module operation requires the web browser to support the Server-sent events (SSE) technology.

#### **Note**

Internet Explorer browser does not support the SSE technology.

The *HTTP-Server* module is configured on the settings panel of the corresponding object – see [Configuring the HTTP-Server object](#).

The requests sent from a web browser are used to work with the *HTTP-Server* module – see [HTTP-Server requests](#).

### 14.2 Configuring the HTTP-Server object

The **HTTP-Server** object is configured as follows:

1. Create the **HTTP-Server** object on the basis of the **Computer** object on the **Hardware** tab of the **System Settings** dialog box (1). The settings panel of the created object will be displayed on the right side of this window.

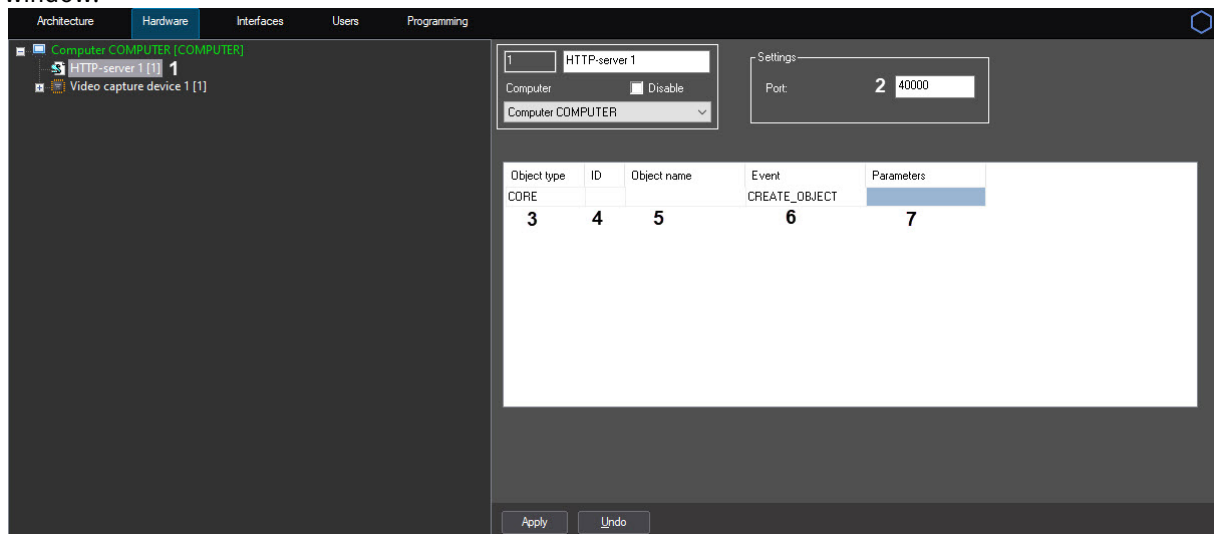

2. In the **Port** field, specify the port number in the system where the client should send the *HTTP-Server* requests (2).
3. Configure the filter for the events which information should be sent by the *HTTP-Server*. If no events are added to the filter, then the *HTTP-Server* will return only the core events (the CORE object) for the client requests. The additional events are selected as follows:
  - a. From the **Object type** drop-down list, select the required *Axxon PSIM* object type (3).
  - b. From the **ID** drop-down list, select the identifier of the object of the selected type (4). If no ID is selected, then the *HTTP-Server* will send the events for all objects of the selected type.
  - c. After selecting the type and object identifier, the **Object name** field will be automatically filled with the name of the corresponding object (5).

- d. In the **Event** field, enter the name of event which should be sent via the *HTTP-Server* (6). If no event is selected, the *HTTP-Server* will send all events of the selected object (or all objects of the selected type). The name of the event is specified in the internal format, for more details see [Description of system object reactions](#). For example, set object type **Camera** and enter "ARM" in the **Event** field to filter camera arming events.
  - e. If it is necessary to send selected events related only to users from the **Access Manager** module (see [Access Manager Module Settings and Operation Guide. Introduction](#)), then enter **objtype<PERSON>** in the **Parameters** field (7). If this parameter is not specified, the events of all objects will be sent.
  - f. Repeat steps a-e for all required objects and events.
4. Click **Apply**.

Configuring the **HTTP-Server** object is complete.

## 14.3 HTTP-Server requests

The requests described below are used when working with the *HTTP-Server* module.

### The last event ID request

GET `http://<IP-address>:<Port>/core/GetLastID`

Request example

GET `http://localhost:40000/core/GetLastID`

Response example

```
{"lastId": "b686658c-764c-e911-8f42-001a7dda710e"}
```

### The event request based on filter

The filter is configured on the settings panel of the *HTTP-Server* object — see [Configuring the HTTP-Server object](#).

GET `http://<IP-address>:<Port>/core/Events?keepAliveTime={keepAliveTime}&startingID={startingID}`

Request parameters:

Parameter	Required	Description
keepAliveTime	No	The time interval in seconds, within which the server will send a json of the <code>{"time": "2019-03-19T14:56:26.317"}</code> form to the client, containing the server time in UTC. The default is 5 seconds.
startingID	No	ID of the event starting from which it is necessary to receive events.

Request example

GET `http://localhost:40000/core/Events?keepAliveTime=5&startingID=8FFCDF07-5E4A-E911-95AE-F894C2A95BA4`

Response example

```
{"module": "video.run", "protocol_id": "2dc6dfcb-5351-e911-8832-534e57000000", "SLAVE_id": "COMP1", "src_action": "MD_STOP", "src_objid": "2", "src_objtype": "CAM", "time": "2019-03-28T12:20:03.977"}
```

## 15 Configuring RabbitMQ

*Axxon PSIM* can act as receiver and transmitter of RabbitMQ events. Download and install the following components from the <https://www.rabbitmq.com/install-windows.html> website before using this functionality:

1. Rabbit service.
2. Erlang.

By default, RabbitMQ has a built-in **guest/guest** account that only works with **localhost**. Create a new account to use RabbitMQ remotely.

The examples below mention the `amqp_sendstring.exe` and `amqp_listen.exe` utilities. These utilities for processing and sending messages from the *Axxon PSIM* are to be implemented by programmer.

The connection to RabbitMQ is configured as follows:

1. Go to the **RabbitMQ** tab on the **Security zone** object settings panel on the **Programming** tab of the **System settings** dialog box (1).

2. In the **Host** field, enter the name or address of the RabbitMQ host (2).
3. In the **Port** field, enter the port to connect with the RabbitMQ host (3). If the port is 0 or not set (by default), the RabbitMQ client does not run.
4. In the **User** field, enter the RabbitMQ user name (4).
5. In the **Password** field, enter the RabbitMQ user password (5).
6. From the Content-type drop-down list, select the data type to be sent and received by *Axxon PSIM* (6):
  - a. **application/json** – a message is sent and received in JSON format. If *Axxon PSIM* cannot parse the message in JSON format, an attempt is made to recognize the message in plain/text format.
  - b. **plain/text** – the *Axxon PSIM* event is sent and received in the format "TYPE|ID|EVENT".
7. Click **Apply** (7).

### 15.1 Axxon PSIM provider and third party receiver

*Axxon PSIM* provider operates in `amq.topic` mode, and the receiver operates in `amq.direct` mode.

amq.topic allows for subscriptions ranging. Each event sent from *Axxon PSIM* is signed with a special header, which is built according to the following scheme:

```
routingkey = "psim.event." + msg.GetSourceType() + "." + msg.GetSourceId() + "." + msg.GetAction();
```

So the receiver can subscribe to any event(s).

Example.

Subscription to all events:

```
amqp_listen.exe localhost 5672 amq.topic psim.event.#
```

Subscription to Action=="RUN" events

```
amqp_listen.exe localhost 5672 amq.topic psim.event.*.*.RUN
```

### Important!

Events enter the RabbitMQ queue from each *Axxon PSIM* core individually. For example, if there are two cores in the system, and the event occurred on a core that has incorrect settings or does not have a connection to RabbitMQ, the event will not get into the queue, despite the fact that the second core will receive it. Each core sends only its own messages.

## 15.2 Axxon PSIM core receiver

The receiver is implemented according to the amq.direct scheme. It is subscribed to all events with the "bindingkey" key. bindingkey should have the following format: "psim." + ComputerName (case sensitive).

When sending, the bindingkey must be specified exactly as it is registered at the receiver, otherwise the message will not be delivered.

Example events that will be receiver by Axxon PSIM core:

text:

```
amqp_sendstring.exe localhost 5672 amq.direct psim.ASUS "CAM|1|HELLO"
```

or JSON

```
amqp_sendstring.exe localhost 5672 amq.direct psim.ASUS {"Type\":"MACRO\",
\"Id\":"1\", \"Action\":"RUN\", \"Params\":{ \"test1\":"+++\", \"test2\":"000\"}
}
```

## 16 APPENDIX 2. NissObjectDLLExt and CoreInterface class declarations

### On the page:

- [CoreInterface](#)
- [NissObjectDLLExt](#)

### 16.1 CoreInterface

```

class CoreInterface
{
public:

    virtual BOOL DoReact    (React&) = 0;

    virtual BOOL NotifyEvent(Event&) = 0;

    virtual void SetupACDevice(LPCTSTR objtype, LPCTSTR objid, LPCTSTR
objtype_reader) = 0;

    virtual    BOOL    IsObjectExist(LPCTSTR objtype, LPCTSTR id) = 0;
    virtual    BOOL    IsObjectDisabled(LPCTSTR objtype, LPCTSTR id) = 0;
    virtual Msg FindPersonInfoByCard(LPCTSTR facility_code, LPCTSTR card)
= 0;

    virtual Msg FindPersonInfoByExtID(LPCTSTR external_id) = 0;

    virtual    CString GetObjectName (LPCTSTR objtype, LPCTSTR id) = 0;
    virtual    CString GetObjectState(LPCTSTR objtype, LPCTSTR id) = 0;

    virtual void      SetObjectState(LPCTSTR objtype, LPCTSTR id,
LPCTSTR state) = 0;

    virtual    BOOL    IsObjectState(LPCTSTR objtype, LPCTSTR id, CString
state) = 0;

```

```

        virtual CString GetObjectParam (LPCTSTR objtype, LPCTSTR id,
LPCTSTR param) = 0;

        virtual int GetObjectParamInt (LPCTSTR objtype, LPCTSTR id,
LPCTSTR param) = 0;

        virtual CMapStringToStringArray* GetObjectParamList(LPCTSTR
objtype, LPCTSTR id, LPCTSTR param) = 0;

        virtual CStringArray* GetObjectParamList(LPCTSTR objtype, LPCTSTR
id, LPCTSTR param, LPCTSTR name) = 0;

        virtual void GetObjectParams (LPCTSTR objtype, LPCTSTR id,
Msg& msg) = 0;

        virtual void SetObjectParamInt (LPCTSTR objtype, LPCTSTR id,
LPCTSTR param, int val) = 0;

        virtual CString GetObjectIdByParam(LPCTSTR type, LPCTSTR param,
LPCTSTR val) = 0;

        virtual CString GetObjectIdByName(LPCTSTR type, LPCTSTR name) = 0;

        virtual CString GetObjectParentId(LPCTSTR objtype, LPCTSTR id,
LPCTSTR parent) = 0;

        virtual int GetObjectIds(LPCTSTR objtype, CStringArray& list,
LPCTSTR main_id = NULL) = 0;

        virtual int GetObjectChildIds(LPCTSTR objtype, LPCTSTR objid,
LPCTSTR childtype, CStringArray& list) = 0;

};

```

## 16.2 NissObjectDLLExt

```

class NissObjectDLLExt
{
    protected:

        CoreInterface* m_pCore;

    public:

        NissObjectDLLExt(CoreInterface* core) { m_pCore = core; }
}

```

```

virtual CString GetObjectType() = 0;

virtual CString GetParentType() = 0;

virtual int GetPos() { return -1; }

virtual CString GetPort() { return CString(); }

virtual CString GetProcessName() { return CString(); }

virtual CString GetDeviceType() { return CString(); }

virtual BOOL HasChild() { return FALSE; }

virtual UINT HasSetupPanel() { return FALSE; }

virtual void OnPanelInit(CWnd*) {}

virtual void OnPanelLoad(CWnd*,Msg&) {}

virtual void OnPanelSave(CWnd*,Msg&) {}

virtual void OnPanelExit(CWnd*) {}

virtual void OnPanelButtonPressed(CWnd*,UINT) {}

virtual BOOL IsRegionObject() { return FALSE; }

virtual BOOL IsProcessObject() { return FALSE; }

virtual BOOL IsIncludeParentId() { return 0; }

virtual BOOL IsWantAllEvents() {

return 0; }

virtual CString DescribeSubscribeObjectsList() { return CString(); }

virtual CString GetIncludeIdParentType(){ return CString(); }

virtual CString DescribeParamLists(){ return CString(); }

virtual void OnCreate(Msg&) {}

virtual void OnChange(Msg&,Msg&) {}

virtual void OnDelete(Msg&) {}

virtual void OnInit(Msg&) {}

```

```
virtual void OnEnable(Msg&) {}  
virtual void OnDisable(Msg&) {}  
virtual BOOL OnEvent(Event&) { return FALSE; }  
virtual BOOL OnReact(React&) { return FALSE; }  
};
```

## 17 APPENDIX 1. DDI file structure

The table below contains the description of the fields of the table from the **Names** tab (the **<Objects>** section).

Field	Description
Name (<ObjectName>)	Object ID name
Visible name (<VisibleName>)	Visible name
Group name (<GroupName>)	The name of a group of objects. Used for grouping objects in <i>Axxon PSIM</i> settings tree

The table below contains the description of the fields of the table from the **Events** tab (the **<Events>** section).

Field	Description
Name (<EventName>)	Event ID name
Description (<EventDescription>)	Event description displayed in the event log
Event handling (<EventType>)	Used to set the background color in the event log: normal – no background color; alarm – red window; information – blue window
Sound support (<IsSoundEnabled>)	A sound file is played when a message is received
Do not send over network (<IsNetworkDisabled>)	Messages will not be sent over the network
Do not log (<IsProtocolDisabled>)	Message will not be displayed in the event log, and event will not be recorded in the database
Windows log (<IsWindowsLogEnabled>)	Record message in the Windows log <i>Note: Recording in the Windows log is impossible, if the event is not logged</i>

The table below contains the description of the fields of the table from the **Reacts** tab (the **<Reacts>** section).

Field	Description
Name (<ReactName>)	Reaction name

Description (<ReactDescription>)	The reaction description displayed in the context menu after a right-click on the object icon on the <i>Map</i>
Flags (<IsReactArm>)	Indication whether the reaction is performed either for a single object or for a group of objects from the same section

The table below contains the description of the fields of the table from the **Icons** tab (the **<Icons>** section).

Field	Description
Filename (<FileName>)	The part of the bmp file name that serves as an image ID. An image ID allows you to use multiple bmp files to show objects of the same type on the <i>Map</i> (see <a href="#">Using the ddi.exe Tool to Work with DDI files</a> )
Name (<IconName>)	The description of the object bmp file

The table below contains the description of the fields of the table from the **States** tab (the **<States>** section).

Field	Description
Name (<StateName>)	State name
Image (<ImgName>)	The part of the bmp file name that serves as a state ID (see <a href="#">Using the ddi.exe Tool to Work with DDI files</a> ).  <i>Note: The Map may display objects using lines, i.e. without using the bmp files. In this case, if an object changes its state, the line color changes. The color (RGB) of a state is set as follows: &lt;State&gt;\$R:G:B</i>
Description (<StateDescription>)	State description
Flashing (<IsStateFlashing>)	Display on the <i>Map</i> : normal – the icon does not flash, alarm – the icon flashes on the <i>Map</i>

The table below contains the description of the fields of the table from the **Transition Rules** tab (the **<Rules>** section).

Field	Description
Event (<EventName>)	The event that triggers the transition
Transition From (<FromStateName>)	The start state from which the transition is made
Transition To (<ToStateName>)	The end state to which the transition is made

## 18 Axxon PSIM software Integration Guide. Postscript

More detailed information on the Axxon PSIM software package is presented in the documents titled:

1. [Administrator's Guide](#);
2. [Operator's Guide](#);
3. [Installing and configuring security system components guide](#);
4. [Programming Guide \(JScript\)](#).

If while operating the given software product you have faced difficulties and problems, you are welcome to contact us. However before addressing us, we kindly ask you to answer the following questions:

1. What is the problem?
2. When did the problem occur and what had happened before it occurred?
3. Which conditions gave rise to the problem?

Remember, that the more detailed and precise information you give us, the faster our experts will resolve your problem.

We are striving to improve the quality of our products, and hence welcome any proposals and suggestions how to improve our software and documentation.